

Metathesis and unmetathesis in Amarasi

Owen Edwards

Studies in Diversity Linguistics 29



Studies in Diversity Linguistics

Editor: Martin Haspelmath

In this series:

1. Handschuh, Corinna. A typology of marked-S languages.
2. Rießler, Michael. Adjective attribution.
3. Klamer, Marian (ed.). The Alor-Pantar languages: History and typology.
4. Berghäll, Liisa. A grammar of Mauwake (Papua New Guinea).
5. Wilbur, Joshua. A grammar of Pite Saami.
6. Dahl, Östen. Grammaticalization in the North: Noun phrase morphosyntax in Scandinavian vernaculars.
7. Schackow, Diana. A grammar of Yakkha.
8. Liljegren, Henrik. A grammar of Palula.
9. Shimelman, Aviva. A grammar of Yauyos Quechua.
10. Rudin, Catherine & Bryan James Gordon (eds.). Advances in the study of Siouan languages and linguistics.
11. Kluge, Angela. A grammar of Papuan Malay.
12. Kieviet, Paulus. A grammar of Rapa Nui.
13. Michaud, Alexis. Tone in Yongning Na: Lexical tones and morphotonology.
14. Enfield, N. J. (ed.). Dependencies in language: On the causal ontology of linguistic systems.
15. Gutman, Ariel. Attributive constructions in North-Eastern Neo-Aramaic.
16. Bisang, Walter & Andrej Malchukov (eds.). Unity and diversity in grammaticalization scenarios.
17. Stenzel, Kristine & Bruna Franchetto (eds.). On this and other worlds: Voices from Amazonia.
18. Paggio, Patrizia and Albert Gatt (eds.). The languages of Malta.
19. Seržant, Ilja A. & Alena Witzlack-Makarevich (eds.). Diachrony of differential argument marking.
20. Hölzl, Andreas. A typology of questions in Northeast Asia and beyond: An ecological perspective.
21. Riesberg, Sonja, Asako Shiohara & Atsuko Utsumi (eds.). Perspectives on information structure in Austronesian languages.
22. Döhler, Christian. A grammar of Komnzo.
23. Yakpo, Kofi. A Grammar of Pichi.
24. Guérin Valérie (ed.). Bridging constructions.
25. Aguilar-Guevara, Ana, Julia Pozas Loyo & Violeta Vázquez-Rojas Maldonado *eds.). Definiteness across languages.
26. Di Garbo, Francesca, Bruno Olsson & Bernhard Wälchli (eds.). Grammatical gender and linguistic complexity: Volume I: General issues and specific studies.
27. Di Garbo, Francesca, Bruno Olsson & Bernhard Wälchli (eds.). Grammatical gender and linguistic complexity: Volume II: World-wide comparative studies.
28. Unterladstetter, Volker. Multi-verb constructions in Eastern Indonesia.
29. Edwards, Owen. Metathesis and unmetathesis in Amara.

ISSN: 2363-5568

Metathesis and unmetathesis in Amarasi

Owen Edwards



Edwards, Owen. 2020. *Metathesis and unmetathesis in Amarasí* (Studies in Diversity Linguistics 29). Berlin: Language Science Press.

This title can be downloaded at:

<http://langsci-press.org/catalog/book/228>

© 2020, Owen Edwards

Published under the Creative Commons Attribution 4.0 Licence (CC BY 4.0):

<http://creativecommons.org/licenses/by/4.0/> 

Indexed in EBSCO

ISBN: 978-3-96110-222-8 (Digital)

978-3-96110-223-5 (Hardcover)

ISSN: 2363-5568

DOI:10.5281/zenodo.3700413

Source code available from www.github.com/langsci/228

Collaborative reading: paperhive.org/documents/remote?type=langsci&id=228

Cover and concept of design: Ulrike Harbort

Typesetting: Owen Edwards

Proofreading: Brett Reynolds, Christian Döhler, Cormac Anderson, Jeroen van de Weijer, Laura Arnold, Ludger Paschen, Sauvane Agnès, Sebastian Nordhoff, Steven Kaye, Tom Bossuyt

Fonts: Linux Libertine, Libertinus Math, Arimo, DejaVu Sans Mono

Typesetting software: X_YLA_TE_X

Language Science Press

xHain

Grünberger Straße 16

10243 Berlin, Germany

langsci-press.org

Storage and cataloguing done by FU Berlin

Freie Universität  Berlin

For Chuck and Om Roni who laid the groundwork in
analysing Amarasi.

Contents

Preface	ix
Acknowledgements	xi
Abbreviations and symbols	xiii
1 Introduction	1
1.1 Overview	1
1.2 Language background	5
1.2.1 Affiliation	6
1.2.2 Amarasi	7
1.3 Previous work	10
1.4 Data for this work	11
1.5 Presentation of data and notational conventions	13
1.6 Goals and the use of theory	16
1.7 Terminology	17
2 Synchronic metathesis from a cross-linguistic perspective	19
2.1 Introduction	19
2.2 Kinds of synchronic metathesis	20
2.2.1 Phonologically conditioned metathesis	21
2.2.2 Morphemically conditioned metathesis	24
2.2.3 Morphological metathesis	26
2.3 Survey of languages with synchronic metathesis	26
2.3.1 Kwara'ae	28
2.3.2 Rotuman	34
2.3.3 Wersing	44
2.3.4 Bunak	46
2.3.5 Luang	48
2.3.6 Leti	51
2.3.7 Roma	58
2.3.8 Mambae	60

Contents

2.3.9	Helong	68
2.4	Origins of synchronic metathesis	76
2.4.1	Origins of umlaut	76
2.4.2	Historic origins of morphological metathesis	79
2.5	Forms of synchronic metathesis	84
2.5.1	Consonant-vowel metathesis	84
2.5.2	Associated phonological processes	85
2.6	Functions of morphological metathesis	85
2.6.1	Metathesis as a construct form	86
2.7	Conclusions	89
3	Phonology and phonotactics	91
3.1	Introduction	91
3.2	Segmental inventory	91
3.2.1	Vowel inventory	91
3.2.2	Consonant inventory	100
3.3	Prosodic structures	105
3.3.1	The CVC syllable	105
3.3.2	The CVCVC foot	108
3.3.3	prosodic word	110
3.3.4	Stress	111
3.3.5	Reduplication	116
3.3.6	Glottal stop insertion	118
3.3.7	Empty C-Slots	123
3.4	Root structure	134
3.4.1	Roots with one foot (root \rightarrow Ft)	135
3.4.2	Roots with a consonant cluster (root \rightarrow C Ft)	139
3.4.3	Roots with a foot and syllable (Root \rightarrow σ Ft)	143
3.4.4	Roots with two feet	144
3.4.5	Monosyllabic roots	145
3.4.6	Root-final consonants	146
3.4.7	Phonotactic nativisation of loan words	146
3.5	Epenthesis	148
3.5.1	Frequency of epenthesis	148
3.6	Consonant deletion	149
3.6.1	Consonant coalescence	151
3.7	Enclitics	152
3.7.1	Vowel-initial enclitics	152

3.7.2	Plural enclitic	153
3.7.3	Sentence enclitics	154
4	Structure of metathesis	159
4.1	Introduction	159
4.2	Basic M-form	161
4.2.1	Metathesis	162
4.2.2	Vowel assimilation	163
4.2.3	Consonant deletion	169
4.2.4	Vowel deletion	172
4.2.5	Irregular M-forms and U-forms	172
4.2.6	No change	174
4.3	Unified analysis	174
4.3.1	Obligatory CVCVC Foot	175
4.3.2	The morphological rule: metathesis	176
4.3.3	The morphemically conditioned rule: assimilation of /a/	178
4.3.4	Summary	182
4.4	Alternate approaches	183
4.4.1	Prosodic morphology	184
4.4.2	Phonologically conditioned metathesis	190
4.4.3	Affixation of consonant-vowel melody	192
4.5	Origins of Amarasi metathesis	194
4.5.1	First intermediate stage	194
4.5.2	Second intermediate stage	196
4.5.3	Loss of final consonants	198
4.5.4	Morphologisation of metathesis	200
4.6	M-forms before consonant clusters	200
4.6.1	Consonant deletion	202
4.6.2	No change	205
4.6.3	Ro'is Amarasi modifiers with an initial cluster	206
5	Phonologically conditioned metathesis and associated processes	209
5.1	Introduction	209
5.2	Metathesis	211
5.3	Consonant insertion	215
5.3.1	Location of the inserted consonant	218
5.4	Vowel assimilation	219
5.4.1	Clitic hosts with final VVCV#	225

Contents

5.5	Clitic hosts with final /a/	227
5.5.1	Clitic hosts with final /Va/	229
5.5.2	Fo'asa' consonant insertion	231
5.6	The plural enclitic	234
5.6.1	Consonant insertion after =n	238
5.6.2	Analysis of /gw/ insertion after VV=n	240
5.7	Multiple enclitics	244
5.8	Historical development	248
5.9	Conclusion	253
6	Syntactically driven metathesis	255
6.1	Introduction	255
6.2	The nominal word class	258
6.2.1	Base for verbal derivation	259
6.2.2	Subject and object	260
6.2.3	Determiners	263
6.2.4	Number enclitics	267
6.3	Attributive modification	271
6.3.1	Loan nominals	273
6.3.2	Proper names	276
6.3.3	Lexicalised attribution	277
6.3.4	Multiple modifiers	278
6.3.5	Ordinal numbers	283
6.3.6	Summary	285
6.4	Possession	286
6.4.1	Possessum determiners	287
6.4.2	Genitive suffixes	289
6.4.3	Syntax of possession	291
6.5	Modifiers which are not nominals	295
6.5.1	Number phrase	296
6.5.2	Determiner phrase	301
6.5.3	Quantifier phrase	303
6.6	Equative clauses	309
6.6.1	Pronominal equative clauses	310
6.7	Serial verb constructions	311
6.7.1	Phonological restrictions on M-forms in SVCs	317
6.8	A prosodic analysis	319
6.8.1	Summary	325

6.9	Conclusion	327
7	Discourse-driven metathesis	329
7.1	Introduction	329
7.2	Syntactically and discourse-driven metathesis	331
7.3	Default M-form	332
7.4	Phonotactic constraints	335
7.4.1	Vowel-initial enclitics	336
7.4.2	Consonant-final U-forms	336
7.4.3	U-forms before consonant clusters	338
7.4.4	Summary	341
7.5	Discourse structures in Amarasi	341
7.6	Dependent coordination	347
7.6.1	Dependent coordination with = <i>ma</i> ‘and’	348
7.6.2	Dependent coordination with = <i>te</i> ‘SET’	351
7.6.3	Dependent coordination with no connector	357
7.6.4	Place names	359
7.7	Tail-Head linkage	361
7.7.1	M-form tail and U-form head	362
7.7.2	U-form tail with M-form head	367
7.7.3	U-form tail with U-form head	370
7.7.4	Elaboration between tail and head	373
7.7.5	Semantically parallel verbs	377
7.8	Poetic parallelism	379
7.9	Centre of chiasmus	385
7.10	Interactional metathesis alternations	390
7.10.1	Question and answer	390
7.10.2	Maintaining interaction	393
7.10.3	Frequency of U-forms in conversation	397
7.10.4	Other interactional resources	398
7.10.5	Summary	407
7.11	Discourse-driven metathesis in Ro’is Amarasi	407
7.11.1	M-forms with final consonant clusters	407
7.11.2	Dependent coordination	411
7.11.3	Negation	412
7.12	Conclusion	413
8	Contributions and conclusions	415
8.1	Metathesis in linguistics	415

Contents

8.2	Metathesis and identity	417
8.2.1	Realisation of U-forms and M-forms	420
8.2.2	Environments for U-forms and M-forms	423
8.3	Metathesis and unmetathesis as complementary pairs	425
8.3.1	Metathetic poetic parallelism	426
8.3.2	Cultural and conceptual complementarity	430
8.3.3	Metathetic parallel complementarity	434
Appendix A: Affixal morphology sketch		439
A.1	Prefixes	439
A.1.1	Verbal agreement prefixes	439
A.1.2	Reciprocal prefix	441
A.2	Circumfixes	442
A.2.1	Nominalising <i>a-...-t</i>	442
A.2.2	Property <i>ma-...-ʔ</i>	443
A.2.3	Nominalising <i>ʔ-...-ʔ</i>	445
A.2.4	Stative <i>m-...-ʔ</i>	446
A.3	Suffixes	448
A.3.1	Genitive suffixes	448
A.3.2	Transitive suffixes	454
A.3.3	Nominalising <i>-t</i>	455
A.3.4	People group suffix <i>-s</i>	456
A.3.5	The suffix <i>-aʔ</i>	457
Appendix B: Survey of morphological metathesis		459
B.1	Introduction	459
B.2	Tunisian Arabic	460
B.3	Svan	462
B.4	Mutsun Ohlone (Costanoan)	462
B.5	Sierra Miwok	464
B.6	Alsea	466
B.7	Salishan	467
B.7.1	Saanich	468
B.7.2	Klallam	470
B.7.3	Halkomelem	472
Appendix C: Selected Amarasi texts		475
C.1	Preface	475

C.2	The death of Nahor Bani	476
C.2.1	Metadata	476
C.2.2	Notes	476
C.2.3	The text	477
C.3	Moo'hitu'	484
C.3.1	Metadata	484
C.3.2	Notes	484
C.3.3	The text	485
C.4	A car accident	493
C.4.1	Metadata	493
C.4.2	Notes	493
C.4.3	The text	494
C.5	Gatmel Bana's family (Ro'is)	502
C.5.1	Metadata	502
C.5.2	The text	502
Appendix D: Text index		513
D.1	Kotos texts	513
D.2	Ro'is texts	534
References		545
Index		556
Name index		556
Language index		561

Preface

This book is a revised version of my PhD Thesis, submitted August 2016 awarded July 2017. The analyses in this work remain broadly the same as those in my PhD thesis, but several areas have undergone substantial revision.

The most significant analytical revision is in the analysis of phonologically conditioned metathesis (Chapter 5). This revision is informed by a proper analysis of the prosodic structures of Amarasi including the Prosodic Word (§3.3). A proper understanding and description of Amarasi prosodic structures was mostly lacking in the earlier work.

Structurally, chapter 2 has been significantly reorganised on the basis of comments from the reviewers in order to clarify the distinction between the three types of metathesis I identify, as well as to avoid shoe-horning languages with multiple kinds of metathesis into a single category.

I have also included a more proper discussion of alternate analyses of the structure of Amarasi metathesis (§4.4), as well as syntactic metathesis (§6.8).

Since the submission of my PhD thesis much more data on other varieties of Meto has also become available. In addition to including such data where it is relevant, it has also informed my analysis of Amarasi in several important respects. Thus, for instance, vowel initial enclitics which were mostly represented as monosyllables in my earlier work are now properly represented as containing two vowels (§5.8).

Of particular prominence is the additional data on Ro's Amarasi (the other major dialect of Amarasi) for which I only had limited preliminary data for my PhD thesis. I have included several sections discussing the Ro's data as it has several important differences to that of Kotos Amarasi (e.g. §4.6.3, §7.11).

Finally, numerous errors have been corrected. These include typographical errors and minor errors in the actual data.

Acknowledgements

Given that this work is a revision of my PhD thesis, I must also revise my acknowledgements. No names need be subtracted from the acknowledgements for my PhD thesis, but several must be added or re-emphasised.

First and foremost, and again, I would like to thank **Heronimus Bani** and **Charles Grimes**. My PhD work would have been a complete disaster without the groundwork laid by Roni and Chuck and subsequently this book would never have appeared. I look forward to continuing to work with them in championing, in whatever small way I can, the languages and peoples of Timor.

Selain itu beta ju mau minta terima kasih buat semua orang Tunbaun dong dengan orang Buraen dong. Khususnya **Om Melo** dengan dia pung keluarga, dan **bapa Toni** dengan **mama Ketsia**; orang dong yang mengajar beta logat Ro'is.

Secondly, I would like to thank the examiners of my thesis: **Anthony Jukes**, **Daniel Kaufmann** and **Marian Klamer**. Their perceptive comments on the submitted version of this thesis led to many useful revisions of that work, some of which have taken until now to be fully implemented.

In particular, Daniel Kaufmann suggested the revised prosodic structure of hosts and enclitics which has made my analysis of phonological metathesis much clearer and more typologically plausible.

Marian Klamer provided me with the job during which I have had the freedom to produce this work. It is with gratitude that I say here that revision of my thesis for publication was supported by the VICI research project “Reconstructing the past through languages of the present: the Lesser Sunda Islands” funded by the Netherlands Organisation for Scientific Research, project number 277-70-012.

Thirdly, I would like to thank the anonymous reviewers who read the submitted version of this book. While it is often frustrating dealing with comments from reviewers, in my experience, they are nearly always on point and addressing them properly yields a better result. I hope these reviewers feel I have honoured the time they put into assessing this work by properly considering their insightful criticisms.

Fourthly, I would like to thank the editors of Language Science Press, **Martin Haspelmath** and **Sebastian Nordhoff** who have guided the manuscript to publi-

Acknowledgements

cation, as well as the proofreaders who caught many of the typographical errors and style issues. Listed in reverse-alphabetical order: **Jeroen van de Weijer**, **Brett Reynolds**, **Ludger Paschen**, **Sebastian Nordhoff**, **Steven Kaye**, **Christian Döhler**, **Tom Bossuyt**, **Laura Arnold**, **Cormac Anderson**, and **Sauvane Agnès**. I would also like to thank **Philipp Konzett** and TROLLing (The Tromsø Repository of Language and Linguistics) where the recordings on which this book is based are hosted.

The deficiencies which undoubtedly remain in this work are entirely my own responsibility and none of the people mentioned in these acknowledgements are responsible for them.

Finally, from the moment I submitted my PhD thesis I have had the pleasure of getting to know **Kirsten Culhane**. I have enjoyed spending time with her and conversations with her have contributed to many different parts of this work. *Bi Kirsten, au 'neek ko msa'*.

Behold, I will create new heavens and a new earth. The former things will not be remembered, nor will they come to mind. (Isaiah 65:17a)

Rarit In re' antuun On anbi 'toko prenatal naan, na'uab am nak, "Amkius mirek-reko', natuin Au u'fe'u are' kanan saa'-saa'." (Rasi Mnitaa neu nai' Yohannis 21.5a)

Abbreviations and symbols

see §1.5 for full notational conventions

<i>sans-serif</i>	Malay code-switching	
\	non-affixal morphophonemic process	(backslash)
–	false start	(en-dash)
=	clitic	(equals sign)
-	affix	(hyphen)
/	ambiguous values of a morpheme	(slash)
🔊	accompanying sound file	(speaker icon)
~	reduplication	(tilde)
—	non-compositional phrase	(underscore)
	epenthesis	(vertical bar)
0	0 person	
1	first person	
2	second person	
3	third person	
ABL	ablative	
ACC	accusative	
ADDR	addressee	
ASSOC.PL	associative plural	
CC	grandchild	
COP	copula	
COUNT	counter	
DAT	dative	
DEM	demonstrative	
DET	determiner	
eSi	elder sibling	
FRD	full reduplication	
GEN	genitive	
IMP	impertive	
INCEP	inceptive	
INTNS	intensive	

Abbreviations and symbols

IPFV	imperfective
IRR	irrealis
LOC	locative
M	M-form (\approx metathesised)
\acute{M}	M-form before consonant cluster (§4.6)
\bar{M}	M-form before vowel initial enclitic (chapter 5)
MB/FZ	parent's opposite sex sibling
mZ	man's sister
NEG	negative
NML	nominaliser
ORD	ordinal
PF	grandfather
PI	plural inclusive
PL	plural
PM	grandmother
PMP	Proto-Malayo-Polynesian
PROH	prohibitive
PROP	property
PSR	possessor
PSM	possessum
PX	plural exclusive
Q	question
QUOT	quotative
RECP	reciprocal
REFL	reflexive
REL	relativiser
RES	resultative
RL	realis
SG	singular
STAT	stative
SUB	subordinate
TOP	topic
TR	transitive
U	U-form (\approx unmetathesised)
\acute{U}	U-form of consonant final stem (§7.4.2) and U-form before consonant cluster (§7.4.3)
ySi	younger sibling

1 Introduction

1.1 Overview

This book is about synchronic metathesis. One well known case of synchronic metathesis comes from Rotuman, in which many words have two forms, such as *pure* ~ *puer* ‘rule, decide’ (Churchward 1940: 14, discussed in more detail in §2.3.2). In this book I present new data from Amarasi, a language which also has synchronic metathesis. Observe the natural textual data in (1) below.

- (1) Going to a party: 130902-1, 1.43 🔊
- a. *oras hai m-nao =te*,
 time 1PX 1PX/2-go =SUB
 ‘While we were going,’
- b. *nai? Owen ina ?piur?=ee n-mouf, n-mofu =ma na-mneuk*.
 Mr. Owen 3SG cloth=3DET 3-fall 3-fall =and 3-lose
 ‘Owen’s handkerchief fell, it fell and was lost.’

The metathesis of Amarasi *mofu* ~ *mouf* ‘fall’ in (1) is formally almost identical to Rotuman metathesis in examples such as *pure* ~ *puer* ‘rule, decide’. In each case the final CV sequence of a CVCV stem metathesises to VC, as illustrated in (2) below with the architecture of Autosegmental Phonology (Goldsmith 1976).

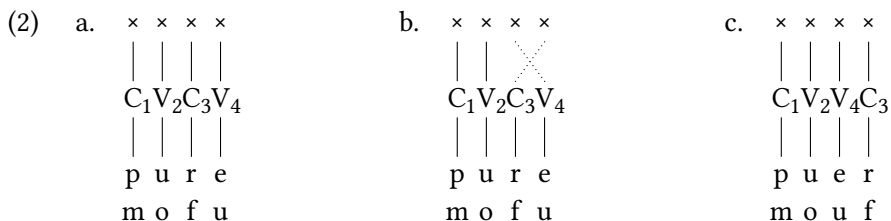

Synchronic metathesis in Amarasi is phonologically very similar to previously described cases in other languages. Furthermore, in certain environments the phonology alone determines whether the metathesised or unmetathesised form

1 Introduction

of a word will appear in Amarasi. However, phonology alone cannot predict that reversal of the position of the metathesised and unmetathesised words in (1) produces a sentence judged ungrammatical by native speakers, as shown in (3).

- (3) * *nai? Owen ina ?piur?=ee n-mofu, n-mouf =ma na-mneuk.*
Mr. Owen 3SG cloth=3DET 3-fall 3-fall =and 3-lose
'(Owen's handkerchief fell, it fell and was lost.)' elicit. 22/02/16 p.19

The forms of synchronic metathesis in several languages have been well described. This has led to much useful discussion about the kinds of phonological models which best handle metathesis, as found in works including Besnier (1987); van der Hulst & van Engelenhoven (1995); Hume (1998); Hume & Seo (2004); Hume (2004), and Heinz (2004), among others.

Despite this interest in the form of synchronic metathesis, there has been relatively little attention given to the functions of synchronic metathesis and the different environments in which an unmetathesised or metathesised form of a word is used. This work partially redresses this imbalance. I provide a detailed analysis of the functions and environments of synchronic metathesis in Amarasi. This includes one instance of phonologically conditioned metathesis and two different morphological uses of metathesis, neither of which can be reduced to a phonologically conditioned process.

I begin in Chapter 2 with a discussion of processes of synchronic metathesis in languages of the world. The focus in this chapter is on languages spoken in the same region as Amarasi, particularly languages with morphological metathesis. There are many similarities in both the form and use of metathesis in these languages. Chapter 2 allows me to position the Amarasi data within its geographic and typological context.

After a discussion of Amarasi phonology and phonotactics in Chapter 3, in Chapter 4 I provide a detailed investigation of the form of metathesis in Amarasi. Depending on the phonotactic structure of the stem to which it applies, metathesis is associated with a bewildering array of disparate phonological processes including vowel deletion, consonant deletion, consonant insertion, and multiple kinds of vowel assimilation. All these phonological processes can be derived from a single process of metathesis and one associated morphemically conditioned process by proposing that Amarasi has an obligatory CVCVC foot in which C-slots can be empty.

The structure of the words *fatu* 'stone', *kaut* 'papaya' and *ai* 'fire' under this analysis are given in (4) below. Evidence independent of metathesis for empty C-

slots in Amarasi is presented in (§3.3.7). Such evidence consists of five language-internal phenomena as well as comparative data.

- (4) a. C V C V C b. C V C V C c. C V C V C
 | | | | | | | | | |
 f a t u k a u t a i

The presence of phonological processes in addition to metathesis leads me to label forms corresponding to unmetathesised forms as *U-forms* and those corresponding to metathesised forms as *M-forms*.¹

In Chapter 5 I analyse phonologically conditioned metathesis in Amarasi. Before vowel-initial enclitics, metathesis occurs to clearly mark a phonological boundary between a clitic host and vowel-initial enclitic. The final consonant of a clitic host is shared between the host and clitic. Metathesis creates a final consonant cluster which is resolved by the final consonant de-linking from the clitic host but remaining linked to the enclitic, thus creating a crisp edge between the host and enclitic.

In chapters 6 and 7 I provide detailed analyses of morphological metathesis in Amarasi. Amarasi has two morphological uses of metathesis: one taken by medial members of phrases (noun phrases or verb phrases) to mark the internal syntactic structure of the phrase and one taken by final members of phrases which marks discourse structures. These two morphological uses of metathesis occur in complementary environments: phrase medial and phrase final. As a result there is no competition between each morphological use of metathesis and no direct structural interaction between them. A single sentence may contain both types of morphological metathesis with the medial members of a particular phrase expressing the internal syntax of this phrase and the final member using metathesis to mark the discourse status of the phrase.

In Chapter 6 I provide a detailed analysis of Amarasi metathesis within the syntax. In the syntax metathesis is a morphological process taken by medial members of a phrase to signal attributive modification. Metathesis is a construct form which marks the presence of a dependent modifier of the same word class as the head, as illustrated in (5a) below. Metathesis alone distinguishes attributive phrases from phrases with a different syntactic structure, such as equa-

¹The terms U-form and M-form can be taken as abbreviations for the form where *U* stands for *unmetathesised* and *M* for *metathesised*. They can also be taken as abbreviations for the functions of these forms, as in the syntax M-forms mark *modification* and in the discourse U-forms mark *unresolved* events or situations. The *U* in U-form can also be an abbreviation for the morphologically *underlying* form.

1 Introduction

tive clauses, illustrated in (5b) below. Within the syntax a metathesised form cannot occur at the end of a phrase and thus usually entails the presence of an unmetathesised form which syntactically completes it. Metathesised and unmetathesised forms comprise a parallel and complementary pair of morphological forms within the syntax.

- (5) a. [NP *faut koʔu*]
stone big
'(a) big stone'
- b. [NP *fatu*] [NP *koʔu*]
stone big
'Stones are big.'

In Chapter 7 I provide a detailed analysis of Amarasi metathesis within the discourse. In the discourse an unmetathesised phrase-final form marks an unresolved event or situation which requires another phrase or clause to achieve resolution. This is the use of metathesis illustrated in (1) above. A discourse-driven unmetathesised form cannot occur in isolation and typically requires a metathesised form to achieve resolution. Unmetathesised and metathesised forms comprise a complementary and parallel pair of morphological forms within the discourse.

I conclude in Chapter 8 with a unified analysis Amarasi metathesis. Metathesis in Amarasi is not merely a phonological epiphenomenon or exotic curiosity. Rather, metathesis is the key which unlocks the structure and genius of the Amarasi language. Metathesis also reflects fundamental Timorese notions of societal and cosmic organisation. Metathesis is one marker of identity in a region obsessed with marking multiple levels of identity between different groups.

The complementarity of metathesis and unmetathesis within the syntax and that within discourse – and also cross-cutting discourse and syntax – reflects the Timorese division of the world into a series of parallel and complementary pairs. More than simply being the key which unlocks the structure of the language, metathesis is a deep reflection of the structure of Amarasi society and culture.

This book also contains four appendices. Appendix A provides a sketch of affixal morphology in Amarasi. Appendix B discusses cases of morphological metathesis in languages outside of the greater Timor region. Appendix C provides four complete glossed Amarasi texts of different genres: one historical narrative, one myth, one conversation and one Ro'is Amarasi narrative. These three texts allow the reader to see how metathesis operates across a complete text. Appendix D provides information and metadata on the texts referred to throughout this book, as discussed further in §1.5 below.

1.2 Language background

Amarasi is a variety of Meto. Meto, also known as Uab Meto, Dawan(ese), Timorese or Atoni,² is a cluster of closely related Austronesian languages and dialects spoken on the western part of the island of Timor; both in the East Timorese enclave of Oecusse, as well as in the Indonesian province of Nusa Tenggara Timur. The location of the Meto cluster is shown in Figure 1.1 along with other languages of Timor. The identity and location of languages in Timor-Leste in Figure 1.1 is mainly based on Williams-van Klinken & Williams (2015).

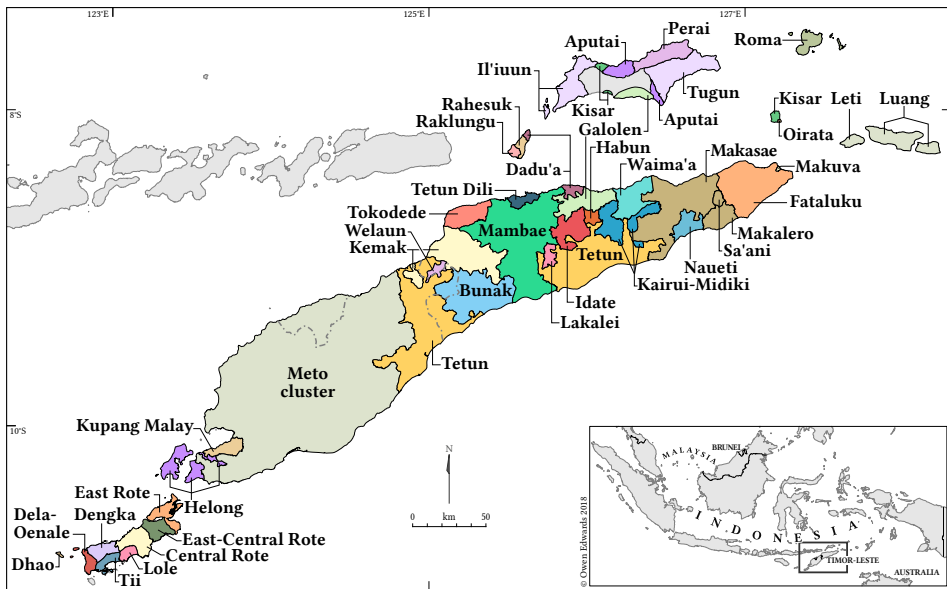

Figure 1.1: Language groups of Timor

Meto speakers think of their speech as a single language and call it (*uab*) *meto?*, (*bahasa*) *timor* or occasionally (*bahasa*) *dawan*. Speakers also recognize more than a dozen named varieties of Meto. These varieties themselves have named dialects, with further differences found between different villages and hamlets of a single dialect. A map of self-identified Meto varieties is given in Figure 1.2.

²In earlier works I referred to this language cluster as Uab Meto. In Amarasi *uab meto?* can be glossed as ‘dry/indigenous speech’. However, not all Meto speaking areas use *uab* for ‘speech’. Thus, in Amfo’an ‘speech’ is *aguab* while in some other areas, such as Timaus, it is *molak*. Use of *Meto* alone as the name of the language cluster thus covers more varieties in an emic manner. It also matches native use in which *meto?* alone can refer to the language. Such use is seen in phrases such as *iin nahiin meto?* ‘S/he knows (how to speak) Meto’.

1 Introduction

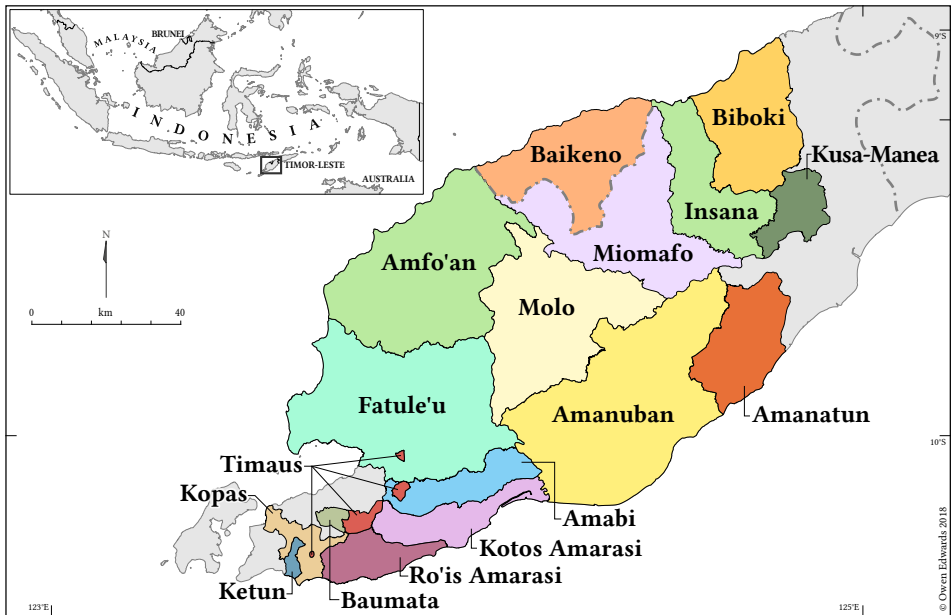

Figure 1.2: Self-identified varieties of Meto

The borders of the self-identified varieties of Meto shown in Figure 1.2 match closely the borders of the pre-colonial political kingdoms of western Timor.³ The extent to which these boundaries follow linguistic differences is unknown. In reality, the Meto cluster is a complex language/dialect chain, and is comparable to more well known cases such as the German chain or the Romance chain. The nature and extent of variation among Meto varieties has not been fully studied. Phonological, lexical, semantic, and grammatical diversity is not insignificant and speakers frequently report difficulty communicating with speakers of other varieties. As a result, Meto speakers of different varieties often use a mixture of Meto and Indonesian/Kupang Malay in order to communicate.

1.2.1 Affiliation

Within Austronesian, Meto belongs to the Malayo-Polynesian subgroup which includes all Austronesian languages outside of Taiwan. It would further belong to Central Malayo-Polynesian within Central-Eastern Malayo-Polynesian (Blust

³The main exceptions are Kusa-Manea, which was part of the Tetun speaking Wehali kingdom, as well as Timaus, Baumata, Kopas, and Ketun, which all appear to be the result of migrations from more northerly areas.

1981; 1993; 2009) but the extent to which these constitute valid linguistic subgroups is contested (Ross 1995; Adelaar 2005; Donohue & Grimes 2008).

Closer to home, the nearest genealogical relative of Meto is the Rote cluster spoken on the island of Rote just to the south-west of Timor. Based on shared sound changes, Rote-Meto can be placed in a Timor-Babar subgroup which contains the Austronesian languages of Timor and south-west Maluku (from Babar island to Wetar island), though excluding Mambae, Tokodede, Welaun, and Kemak which form a Central Timor subgroup (Edwards 2018c; 2019).

While Meto is demonstrably Austronesian, it has strong influence from at least one – probably more – pre-Austronesian languages of the region (Edwards 2016c; 2018a). This substrate is reflected at all levels of the language: lexicon, phonology, morphology, and syntax.

Typologically, Meto fits well in the Melanesian linguistic area with four to five of the six properties identified by Schapper (2015) as constituting this area. The only property of linguistic Melanesia which Meto unambiguously lacks is that of having complex numerals below ten. Apart from this Meto has genitive-noun order, absence of velar nasal /ŋ/, noun-numeral order and possessive classification, all of which are typical of linguistic Melanesia.

Another property of linguistic Melanesia is verb-negator order. Regarding this property, most varieties of Meto for which data is available have double negation with *ka=* occurring before the verb and *=fa* after the verb. However, Ro'is Amarasi has post-verbal *=mae?* while Amfo'an only has pre-verbal *ka=*.

While Meto fits well within linguistic Melanesia, it is, based on current understanding, only a peripheral member of linguistic Wallacea as identified by Schapper (2015). Schapper gives four properties of linguistic Wallacea: cognates of #muku 'banana', neuter gender, semantic alignment, and synchronic metathesis. Of these, Meto only has synchronic metathesis.

1.2.2 Amarasi

Amarasi is spoken towards the south-west end of the Meto speech area. One salient feature which sets Amarasi apart from most other Meto varieties is the liquid /r/ instead of /l/; most Meto varieties have only a single liquid.⁴

Amarasi speakers identify three Amarasi dialects: Kotos, Ro'is, and Tais Nonof. Current data indicates that Tais Nonof is a label for the speech of those living along the coast of the Amarasi area, including those whose speech is most sim-

⁴Amabi also has /r/ instead of /l/ as does Kusa-Manea, though /l/ occurs in many Tetun loanwords in Kusa-Manea. Timaus has both /l/ and /r/ due to a *dʒ > /r/ sound change.

1 Introduction

ilar to Kotos Amarasi and those whose speech is most similar to Ro'is Amarasi. Amarasi speakers also report that the Amabi variety of Meto is very similar to their own speech with minor lexical differences.

Differences between Kotos Amarasi and Ro'is Amarasi include different functors (grammatical morphemes), lexicon, phonotactics, as well as having undergone different sound changes. A number of functors in Ro'is and Kotos Amarasi are shown in Table 1.1 as a sample of the divergence between these two lects.

Table 1.1: Different Kotos and Ro'is functors

Kotos	Ro'is	gloss	Kotos	Ro'is	gloss
<i>he</i>	<i>nu</i>	IRR	<i>ia</i>	<i>ai</i>	1DEM
<i>re?</i>	<i>he?</i>	REL	<i>nee</i>	<i>nae</i>	3DEM
<i>ka=...=fa</i>	<i>mae?</i>	NEG	<i>iin</i>	<i>hiin</i>	3SG
<i>on</i>	<i>en</i>	IRR.LOC	<i>=een</i>	<i>=heen</i>	INCEP
<i>n-bi</i>	<i>n-bi?aak</i>	RL.LOC	<i>nai</i>	<i>neu</i>	already
<i>et</i>	<i>ek/et</i>	IPFV.LOC	<i>u-</i>	<i>ku-</i>	1SG
<i>n-ak</i>	<i>tau?/n-ak</i>	QUOT	<i>-k</i>	<i>-r</i>	3PL.GEN
<i>n-eu</i>	<i>n-uu</i>	DAT	<i>a-...-t</i>	<i>ka-...-t</i>	NML

In fact, looking only at linguistic structures and shared sound changes, Kotos Amarasi is more closely related to other varieties of Meto than it is to Ro'is Amarasi. Nonetheless, speakers of Kotos and Ro'is self-identify their speech as more similar to one another than to other Meto varieties. They frequently interact together and both share a common history as members of the Amarasi kingdom. Thus, from a socio-historical perspective, Kotos and Ro'is can be considered “dialects” of a single language.⁵

Data from Kotos Amarasi forms the basis of this book. I present Ro'is Amarasi data at various points when it bears on the analysis of Kotos Amarasi and/or differs in important respects. My Kotos data comes mostly from the hamlet (*kampung*) Koro'oto, in the modern village (*desa*) Nekmese'. My Ro'is data comes from the hamlet of Suit in the village of Buraen, as well as the hamlets of Batuna and Ruanrete in the village of Tunbaun. The locations of these villages within the Amarasi speech area are shown in Figure 1.3.

⁵Kotos and Ro'is speakers perceive their speech as closer to one another based on salient commonalities not found in nearby varieties of Meto. Such commonalities include /r/ instead of /l/ and lexical items, such as *ko?u* ‘big’ instead of *?naek*, or *n-kono* ‘keep going’ instead of *n-fini*.

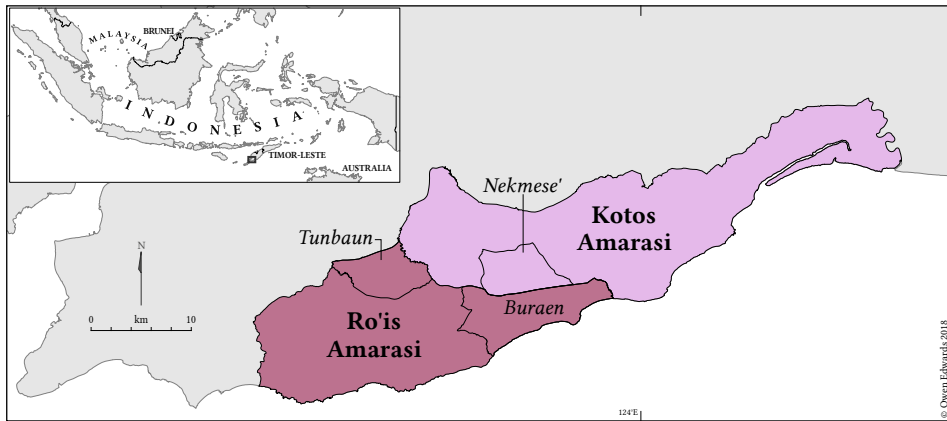

Figure 1.3: Locations of Nekmese', Buraen, and Tunbaun

From 1968–1975 west Timor underwent an administrative restructure with the creation of the administrative units of districts (*kecamatan*) and villages (*desa*). In Amarasi 60 hamlets were amalgamated into 23 villages. In parts of Amarasi this amalgamation was also accompanied by the physical relocation of traditional hamlets in order to allow for a more efficient development of infrastructure and delivery of services.

Nekmese' – data from which forms the core of this work – was created by the amalgamation of four hamlets: Koro'oto, Fo'asa', Tuamese' and Naet. These hamlets still exist as *dusun* (the administrative level below *desa*) and form the basis of the parishes of the dominant Christian denomination in the village (the protestant GMIT church⁶) People also maintain their gardens and fields in the vicinity of the old hamlets.⁷

Despite the administrative and physical restructure of 1968–1975, the traditional hamlets of Nekmese' are alive and well as distinct social and linguistic units. A summary of the speech variety which is the focus of this work is given in (6) below. Unless explicitly labelled otherwise, all data is Kotos Amarasi from the hamlet of Koro'oto.

⁶GMIT is an acronym of *Gereja Masehi Injili di Timor*; for which the official translation is 'The Evangelical Protestant Church of Timor'. There are four GMIT parishes in Nekmese': one serving Koro'oto, one for Fo'asa' and Tuamese', and two for Naet.

⁷Inhabitants of Koro'oto have moved the furthest, with *desa* Nekmese' being located close to the original locations of Fo'asa' and Tuamese'. The inhabitants of Naet have moved from their original location towards Nekmese', but Naet remains dislocated from the rest of Nekmese'. The inhabitants of Naet speak the Tais Nonof variety of Amarasi.

1 Introduction

- (6) a. Language: *Meto*
- b. Variety: *Amarasi*
- c. Dialect: *Kotos*
- d. Hamlet: *Koro'oto*

1.3 Previous work

The earliest description of Meto known to me is Müller (1857), which contains a wordlist in what is probably a variety of Molo. After this, the next earliest work is Kleian (1894) which contain what appears to be an Amanuban wordlist, though forms from other varieties are also given.

There are also works by the Dutch linguist J. C. G. Jonker which contain data on Meto. This includes Jonker (1904: 270f) which is a one page glossed Amfo'an text with notes. Jonker (1906) discusses word-final consonants in a number of Austronesian languages including Meto. The Meto data in Jonker (1906) is mostly Amfo'an, though data on other varieties, including Amarasi, is also given. Much of Jonker's Meto data also occurs in etymological notes in Jonker (1908); an 805-page dictionary of the Termanu variety of the Rote cluster.

Capell (1944a) provides a wordlist in Meto "from Dutch sources". This appears to be based on Jonker's data and Jonker (1906) is the source for the discussion of final consonants in Capell (1944b: 29).

The first in depth treatment of Meto is that of the Dutch missionary Pieter Middelkoop. Middelkoop published a collection of Amarasi texts (Middelkoop 1939) which had been previously collected by Jonker, a collection of funeral chants (Middelkoop 1949), and a sketch grammar of Molo (Middelkoop 1950). The other work by Middelkoop is an unpublished 673-page draft dictionary of Molo, which was still in preparation before his death (Middelkoop 1972).⁸ Middelkoop's materials on Meto contain much valuable data. However, the transcription employed by Middelkoop is not phonemic and certain contrasts are under-represented.

There are also a number of papers on Meto by Hein Steinhauer, who worked on the Nilulat dialect of Miomafo. This includes a description of verb morphology (Steinhauer 1993) and a series of papers which provide an initial description of the form of metathesis within the noun phrase (Steinhauer 1996a,b; 2008).

Other works which I have been able to access on Meto include a Masters Thesis on Miomafo (Talul 1988), a grammar produced by the Indonesian Pusat Ba-

⁸Thanks goes to James Fox for giving me his copy of Middelkoop (1972).

hasa (Tarno et al. 1989),⁹ a description of quantification in Amanuban (Metboki & Bellamy 2014), an Optimality Theory account of the segmental phonology of Miomafo (Isu 2013), a description of consonant insertion in Nai'bais Amfo'an (Culhane 2018), and a discussion of serial verb constructions in Amarasi as being one source of similar constructions in Kupang Malay (Jacob & Grimes 2011).

1.4 Data for this work

The core of the Amarasi data on which this work is based is a corpus of recorded texts totalling nearly nineteen hours of which about five hours has been processed. This includes a little more than three hours of transcribed, translated, and glossed Kotos texts, as well as just over two hours of transcribed and translated Ro'is texts. These texts are of a variety of genres and include narratives, folk-tales, conversations, and traditional poetry.

An index of the texts which comprise this corpus is given in Appendix D. These texts are archived with the Pacific And Regional Archive for Digital Sources in Endangered Cultures (PARADISEC) and nearly all are freely downloadable.

My Kotos texts were collected in three field trips totalling seven months I made in 2013, 2014, and 2016 over the course of my PhD work. During these field trips I was hosted in Timor by Heronimus Bani (Roni), a native speaker of Amarasi, in the village of Nekmese'. These texts were recorded either by me or by Roni and then transcribed and translated by native speakers of Amarasi, either Roni or Yedida Ora (Oma). I then checked the initial transcriptions against the recording and glossed the text in Toolbox. All my Kotos Amarasi texts can be accessed from <http://catalog.paradisec.org.au/collections/OE1>.

During 2012 I was a participant in a two week language documentation workshop held in Kupang: *Preserving Knowledge through Recording and Writing Local Languages*. During this workshop a number of additional Kotos Amarasi texts were recorded and transcribed by Oma.

My Ro'is texts were collected during a field trip at the end of 2018 while undertaking an Australia Awards Endeavour Fellowship. During this trip I spent one week in Buraen with Toni Buraen and his family, followed by two weeks in Tunbaun with Melianus Obhetan and his family. I transcribed my Ro'is Amarasi texts and then checked them with native speakers. My Ro'is Amarasi texts can be downloaded from <http://catalog.paradisec.org.au/collections/OE2>.

⁹Thanks goes to Patrick McConvell for providing me with his copies of Talul (1988) and Tarno et al. (1989).

1 Introduction

In addition to this text corpus, I also conducted a number of elicitation sessions with Roni in 2016. This elicitation involved working through recorded texts with Roni and manipulating individual parts of sentences for grammaticality judgements. When a manipulated sentence was accepted as grammatical, I would then have Roni say it back to me. This often resulted in him rejecting a sentence he had originally accepted. Elicitation was also carried out with Oma on a number of occasions.

This data is supplemented by a translation of the New Testament and Genesis into Kotos Amarasi: *Unit Bahasa & Budaya* (2015).¹⁰ This translation was carried out by native Amarasi speakers and is completely natural and idiomatic Amarasi as evidenced by the fact that it is full of grammatical constructions that differ from both Indonesian and Kupang Malay (used as front translation). Before publication this translation was checked with at least three different groups of native speakers comprising three or more speakers in each group (representing a good cross section of age, gender, and educational levels) for clarity and naturalness. The material was tested and further refined with each successive group, then followed by a smoothing read-through looking at naturalness and flow before publishing.

Data from this translation is presented when it contains good, clear exemplars of rare constructions. However, no part of my analysis rests solely on data found only in the Amarasi Bible translation. See Heider et al. (2011) and Dryer (2013: 2) for discussion of the use of Bible translations as sources of linguistic data.

A final source of Kotos Amarasi data is a series of primary school readers translated from Kupang Malay into Amarasi by Yedida Ora (Ora 2016a,b,c). These readers have also been checked and edited for naturalness and fluency.

In addition to all this Amarasi data, I also have also collected data on the following varieties of Meto, some of which appears at various points in this book: Timaus (half an hour of transcribed, translated, and glossed texts, as well as 1 hour 15 minutes untranscribed texts, lexicon of 685 headwords), Kusa-Manea (four hours of untranscribed texts, lexicon of 488 headwords), Amanuban (22 untranscribed texts, 8 wordlists), Ketun (3 untranscribed texts, 3 wordlists), Kopas (3 untranscribed texts, 5 wordlists), Fatule'u (2 wordlists), and Amfo'an (1 wordlist). I also have Baikenno data collected during the 2012 Kupang language documentation workshop, as well as data collected and provided by Charles Grimes. Unless otherwise cited, all Meto data in this book comes from these sources.

¹⁰This translation can be accessed online at www.e-alkitab.org or downloaded for free on Android devices from Google Playstore (search: Amarasi Bible).

1.5 Presentation of data and notational conventions

Data from Amarasī, or another variety of Meto, is transcribed phonemically and presented in italic font.¹¹ Example sentences are given with up to two gloss lines. A typical example is given in (7) below.

- (7) *ahirŋa* *ahh, n-aim* *naan baardɔ̄=esa =m na-maika? n-*
ahirŋa *n-ami* *naan bare=esa =ma na-maika?*
 in.the.end 3-look.for\M 2DEM place\̄=one =and 3-settle
 ‘In the end, he looked there for a place and settled.’ 120715-4, 0.55 🔊

The first line is the phonemic transcription with morpheme breaks indicated. Affixes are separated by the hyphen -. Enclitics are separated from their host by the equals sign =. Vowel initial enclitics which induce morphophonemic processes on their host (Chapter 5), are attached directly to the host, while other enclitics are offset. An example of each kind of enclitic can be seen in (7) with vowel initial =*esa* ‘one’ and consonant initial =*m* ‘and’.

Word-initial epenthetic /a/ is separated by the vertical line |. The underscore _ is used to separate two parts of a phrase with a non-compositional meaning or phrases where one element does not occur independently. An example of epenthesis occurs in *a/n-kobub* ‘piled up’ in (8) below, and an example of a non-compositional phrase is *paha_?pinan* ‘country_below’ = ‘world’ in (8).

Instances of Indonesian/Kupang Malay code-switching or unassimilated loans are transcribed in a sans-serif typeface. Thus, in example (7) the word *ahirŋa* ‘in the end’ is from Kupang Malay *ahirnya*. Phonetic strings which are pauses are indicated by a final <hh> and are usually unglossed. In example (7) *ahh* is a pause with the phonetic quality approximating [a:], similarly *nehh* is a pause which sounds like [nɛ:]. False starts are not glossed and indicated by a final en-dash -. One example is the final *n-* in example (7) above. Commas indicate pauses and/or intonation breaks and full stops represent the end of an intonation unit. Capital letters are only used for proper names.

The second line gives the underlying form of morphemes before processes of metathesis, consonant insertion, and vowel assimilation occur. It also gives the

¹¹There are only three non-phonemic aspects of my transcription. Firstly, foreign proper names are transcribed orthographically when they contain non-native phonemes the IPA representation of which is not identical to their orthographic, e.g. *Lince* [lɪntʃe]. Secondly, /gw/ is transcribed <g> before rounded vowels (§3.2.2.1). Thirdly, /n/ → [ŋ] is transcribed <ng> when it occurs before /gw/ without an intervening morpheme break. These last two non-phonemic conventions can be seen in the word for ‘teacher’, which according to my analysis has the form /tungwuru/, but is transcribed as *tunguru*.

1 Introduction

underlying forms of enclitics which have multiple forms (§3.7.3). The third line gives the morpheme by morpheme gloss. When a morpheme is ambiguous between several values, these values are separated by a slash /. An example is the verbal agreement prefix *m-* ‘1PX/2’ which agrees with first person exclusive, second person singular, and second person plural. Glosses mostly follow the Leipzig Glossing Rules with a full list of glosses used in this book, including non-standard glosses, given beginning on page xiii.

Table 1.2: Glosses for U-forms and M-forms

Gloss	Use
U	U-form
Ī	1. U-form of consonant-final stem 2. U-form before consonant cluster
M	M-form
Ḅ	M-form before vowel-initial enclitic
Ḅ̄	M-form before consonant cluster

Glosses indicating U-forms and M-forms are usually only given when potentially relevant to the discussion at hand. Glosses for U-forms and M-forms in different phonotactic environments are given in Table 1.2, with a number of examples given in (8)–(11) below. See Chapter 4 for more discussion of the distribution of each of these forms. Glosses for U-forms or M-forms are not given when a form does not distinguish between them.

- (8) *nenō naa paha_?pina-n ia, a|n-kobub on bare mese?*
nenō naa paha_?pina-n ia n-kobub on bare mese?
 day\U 0DEM land_below\U-3SG.GEN 1DEM 3-pile\Ī IRR.LOC place\U one

‘In those days the world was piled up in one place.’ 120715-4, 0.05 🔊

- (9) *uma ?-tee =ma, ?-aiti bruuk.*
uma ?-tea =ma ?-aiti bruuk
 1/2SG\come\Ī 1SG-arrive =and 1SG-pick.up\Ī pants\U

‘I arrived (home) and picked up some pants.’ 130825-6, 10.05 🔊

- (10) *hii m-euk siisḋ=ii =m*
hii m-eku sisi=ii =ma
 2PL 1PX/2-eat\M meat\Ḅ=1DET =and

‘You ate the meat and’ 120923-1, 6.01 🔊

1.5 Presentation of data and notational conventions

- (11) *afi_naa au ?-tae iin sura srain?=ii =t*
afi_naa au ?-tae ini surat srani?=ii =te
 yesterday 1SG ?-look.down 3SG paper\M baptism\M=1DET =SUB
 ‘Yesterday when I looked at her baptismal certificate,’ 130821-1, 6.20 

Gloss lines are followed by a free translation into English. Words not present in the Amarasi example but supplied in the free translation to increase its naturalness are enclosed in brackets (). Important para-linguistic information such as gestures are described in square brackets [] in the free translation. Occasionally a literal translation of part or all of the Amarasi example is given. Literal translations are enclosed in brackets and preceded by the abbreviation ‘lit.’.

The numeric code to the right of the free translation is a reference to which text the example comes from. These codes follow the format *yy-mm-dd-no.*, *time in text*. Thus, the code 120715-4, 0.55 in example (7) above indicates that this example begins at about 55 seconds into the fourth recording made on the 15/07/2012.

Examples with the speaker icon  have an accompanying sound file. These sound files can be downloaded from TROLLing (The Tromsø Repository of Language and Linguistics) at <https://doi.org/10.18710/IORWF6> (Edwards 2020). These sound files are organised in the repository according to the chapter in which they occur with additional information on their specific location, such as example or table number, embedded in the file name. See the ReadMe in the TROLLing repository for a complete explanation.

In addition to examples from my text collection, three other kinds of examples occur. Firstly, data which was encountered during the course of my fieldwork but not recorded is indicated as *observation* usually with the date and page reference to my notebook; e.g. *observation 09/10/14, p. 113*. Secondly, data which were collected during elicitation are marked as *elicit.* with the date and page reference to my notebook; e.g. *elicit. 15/03/2016 p.47* Finally, data from the Amarasi Bible translation are referenced by book, chapter, and verse, e.g. *John 3:16*.

When longer examples from a single text are given, a short description usually precedes the text (followed by the unique code cross referencing the text). The data following this title is then labelled alphabetically. An example is given in (12) below. When an example involves more than one speaker, different speakers are indicated with Greek letters.

- (12) How Moo'-hitu made the world: 120715-4 
- | | | | | |
|----|--|----------------|------------------|------------------|
| a. | <i>n-bi~bi</i> | <i>oodʒ=ee</i> | <i>naan-n=ee</i> | <i>onai =te,</i> |
| | <i>n-bi~bi</i> | <i>oe=ee</i> | <i>nana-n=ee</i> | <i>onai =te</i> |
| | 3-INTNS~RL.LOC water=3DET inside-3SG.GEN=3DET and.then | | | |
| | ‘Having been in the water for a while,’ | | | |
- 0.43

1 Introduction

- b. *a/n-moʔe =ma n-pooɕ=ena n-bi metoʔ.*
n-moʔe =ma n-poi=ena n-bi metoʔ
3-make =and 3-exit=INCEP 3-RL.LOC dry
'(he) made and went out onto dry land.' 0.45

When data on languages other than Amarasi or Meto is cited, such data is transcribed in italics phonemically according to IPA conventions.¹² Data from languages with a widely used standard orthography are usually transcribed orthographically followed by a phonemic IPA transcription, an example is English *mouse* /maʊs/.

1.6 Goals and the use of theory

The main goal of this book is to present an accurate description of the forms and functions of metathesis in Amarasi (chapters 4–7). A secondary goal is to propose a clear analysis of the data. A third goal is to situate the Amarasi data within its typological, geographical, and cultural context (Chapters 2 and 8)

Notably, it is *not* the main goal of this book to present the Amarasi data as an argument in favour of any particular theoretical model. While I make frequent use of representations and tools from different theoretical models, I do so mainly to illustrate clearly aspects of the Amarasi data in a helpful way and as explicit strategy to summarise certain generalisations.

Thus, in Chapters 4 and 5 I make use of Autosegmental theory as it helpfully illustrates the processes which occur in the derivation of M-forms from U-forms. Similarly, in describing M-forms before consonant clusters §4.6 I make use of Optimality Theory as the tableaux of this theory illustrate well the large number of potential outputs a particular string could generate. Likewise, in Chapter 6 I make use of X-bar theory to analyse the role of metathesis within the syntax.

In general, different theoretical models and the analyses these entail are deployed in this book in an expedient manner according to what seems most illuminating for the Amarasi data. The primary use of theory is to present a clear and simple analysis of Amarasi metathesis, not a theoretically consistent analysis. Thus, the observant reader will note, for instance, that in my account of phonologically conditioned metathesis in Chapter 5 I make frequent use of constraints developed within Optimality Theory without ever presenting an Optimality Theory tableau. While I find some Optimality Theory constraints helpful in under-

¹²For the sake of complete clarity, the palatal glide /j/ is always transcribed <j> while the palatal affricate /ɕ/ is always transcribed <ɕ>.

standing the data, an actual account embedded within Optimality Theory clouds rather than illuminates the description.¹³

The main exception to this approach is in the analysis of the structure of metathesis in Chapter 4. In this chapter I explicitly formulate an analysis using an autosegmental model of phonology (Goldsmith 1976) and a rule-based model of process morphology (Matthews 1974; Anderson 1992). I do this because these models allow me to propose a unified analysis of the form of Amarasi metathesis.

However, my primary commitment is not to any particular theory, or any particular analysis, but to the Amarasi data itself. I would welcome criticism of the analyses proposed in this book so long as any alternate analyses remain faithful to the primary data upon which any analysis must be based. Similarly, I would welcome any dialogue with this book which attempts to provide a unified theoretical account of all of the data.

1.7 Terminology

In this section I give definitions of potentially ambiguous linguistic terminology. The definitions given here should be taken only as a practical guide to understand how terms are used in this book and should *not* be taken as strong claims about the theoretical status of any of the elements defined.

As used in this book, a *word* is the minimal meaningful phonological string which can occur in isolation.¹⁴ A *morpheme* is “an indivisible stretch of phonetic (or phonological) material with a unitary meaning” (Anderson 1992: 49).¹⁵ A *root* is an underlying single morpheme without any affixes attached.

We can furthermore distinguish between *bound* and *free morphemes*. A free morpheme is a root which can occur as a word without any other morphemes attached. A typical example is *kaut* ‘papaya’. A bound morpheme is a root which cannot occur as a word. Instead a bound morpheme must surface attached to another morpheme. A *clitic* is a morpheme which is phonologically bound to a clitic host, but has a separate syntactic status to the host. A typical example is

¹³This is not to say that Optimality Theory is wrong, or that it cannot or should not be used to analyse Amarasi metathesis. Instead, I merely do not find a full Optimality Theory account of this aspect of Amarasi metathesis a helpful aid.

¹⁴Two typical environments in which words occur in isolation are in response to a question or in collection of a wordlist. Likewise, pauses are not usually allowed in the middle of a word. If such a pause occurs, the speaker usually repeats the entire word from the beginning.

¹⁵In many morphological theories the morpheme does not play a central role, including Matthews (1974); Anderson (1992) and Stump (2001). While I am extremely sympathetic to such theories, the morpheme is still a useful analytic tool for much of the Amarasi data.

1 Introduction

the determiner =*ee*, which marks definiteness. While this determiner must occur attached to a host (e.g. *kaut=ee* ‘the papaya’) which is the head of a noun phrase, the enclitic itself is the head of a separate determiner phrase (§6.5.2). My definitions of all these terms when applied to Amarasi or Meto data are summarised in (13) below, with a number of examples also given.

- (13) Terminological definitions
- a. Morpheme = indivisible phonetic stretch with unitary meaning
n- ‘third person verbal agreement’, *kobub* ‘pile up’, *kaut* ‘papaya’, =*ee* ‘3DET, third person determiner’
 - b. Word = minimal phonological string which can occur in isolation
n-kobub ‘piles up’, *kaut* ‘papaya’, *kaut=ee* ‘the papaya’
 - c. Bound morpheme = morpheme which cannot occur as an independent word
n- ‘third person verbal agreement’, =*ee* ‘3DET’
 - d. Root = underlying single morpheme
 $\sqrt{n-}$ ‘third person verbal agreement’, \sqrt{kobub} ‘pile up’, *kaut* ‘papaya’,
 $\sqrt{=ee}$ 3DET
 - e. Free morpheme = morpheme which is an eligible word
kaut ‘papaya’, *teun* ‘three’
 - f. Affix = bound morpheme with no separate syntactic status to its host
n- ‘third person verbal agreement’, =*m* 1PX/2GEN ‘first person exclusive or second person genitive’
 - g. Clitic = bound morpheme with different syntactic status to its host
=*ee* ‘3DET’, =*ma* ‘and’, =*kau* ‘1SG.ACC’
 - h. Stem = a word or root to which a bound morpheme attaches
n-kobub ‘piles up’, *kaut=ee* ‘the papaya’
 - i. Citation Form = usual form of a word given in wordlist style elicitation

I also make a distinction between two kinds of words and roots, *functors* and *lexical words/roots* (Zorc 1978; Grimes 1991: 85ff). Functors are morphemes which have grammatical uses, such as relativisers, demonstratives, topic markers, and pronominals, while lexical words/roots typically refer to events, states, properties, and things.

2 Synchronic metathesis from a cross-linguistic perspective

2.1 Introduction

In this chapter I discuss synchronic metathesis from a cross-linguistic perspective. I begin in §2.2 with a categorisation of the different types of synchronic metathesis that are found in languages of the world. After this I provide a survey of languages with synchronic metathesis in §2.3, focussing on those of greater Timor – the region where Meto is spoken. This is followed by a discussion of the origins of synchronic metathesis in §2.4, and a summary of the forms and functions of synchronic metathesis in §2.5 and §2.6 respectively.

Probably the most familiar kind of metathesis is historic metathesis in which a sequence of two sounds has swapped position at some point in the history of the language. One case of historic metathesis is found in Dutch in which rhotic-vowel sequences metathesised before certain dental consonants (de Vaan 2017: 108). An example is Dutch *borst* /bɔrst/ ‘breast’ which can be compared with German *brust* /brʊst/ or English *breast* /brɛst/ each of which preserves the older rhotic-vowel order.

Synchronic metathesis, on the other hand, is when at least some words in a language have alternate forms in certain situations which differ in the order of some of their segments in a regular and systematic way. Thus, in Rotuman (§2.3.2) the word for ‘flower’ is either *hosa* or *hoas* (Churchward 1940: 14).

One phenomenon excluded from my discussion in this chapter which could be considered metathesis is that of affixes which have both stem internal and stem external allomorphs. One example is found in Ulwa (Misumalpan, Nicaragua) in which the 3SG.GEN affix *-ka/⟨ka⟩* attaches to the first iambic foot of the stem.¹ This affix surfaces as a suffix when a word consists of only a single iambic foot and as an infix when the first iambic foot is followed by other syllables. Examples are given in (1) below.

¹An iambic foot in Ulwa consists of a light syllable followed by a heavy syllable, two light syllables, or a single heavy syllable.

2 Synchronic metathesis from a cross-linguistic perspective

- (1) Ulwa 3SG.GEN *-ka* (Hale & Blanco 1989 in McCarthy & Prince 1993b)

<i>bas</i>	→	<i>bas-ka</i>	‘hair’
<i>ki:</i>	→	<i>ki:-ka</i>	‘stone’
<i>sana</i>	→	<i>sana-ka</i>	‘deer’
<i>amak</i>	→	<i>amak-ka</i>	‘bee’
<i>sapa:</i>	→	<i>sapa:-ka</i>	‘forehead’
<i>su:lu</i>	→	<i>su:<ka>lu</i>	‘dog’
<i>asna</i>	→	<i>as<ka>na</i>	‘clothes’
<i>siwanak</i>	→	<i>siwa<ka>nak</i>	‘root’
<i>ana:la:ka</i>	→	<i>ana:<ka>la:ka</i>	‘chin’
<i>karasmak</i>	→	<i>karas<ka>mak</i>	‘knee’

This chapter provides the typological context for my description of metathesis in Amarasí. Because of this, I frequently provide forward references to later sections of this book in which Amarasí phenomena similar to those under discussion are provided.

2.2 Kinds of synchronic metathesis

In this section I present a categorisation of processes of synchronic metathesis. I identify three kinds of metathesis: phonologically conditioned metathesis (§2.2.1), morphemically conditioned metathesis (§2.2.2), and morphological metathesis (§2.2.3). The categorisation into these three types of metathesis is intended to facilitate an understanding of different metathesis patterns and their systematicity. I discuss each type of synchronic metathesis and relate them to other, more familiar, phonological processes.

It is frequently the case that a unitary analysis of a single process of synchronic metathesis is not always possible. Such a process of metathesis may be phonologically conditioned in some environments, morphemically conditioned in others, and morphological in yet other situations. This, for instance, is the situation with Rotuman metathesis (§2.3.2). It is also the situation in Amarasí which has phonologically conditioned metathesis before vowel-initial enclitics (Chapter 5) and two process of morphological metathesis (Chapter 6 and 7).

One kind of synchronic metathesis which does not fit into any of these three categories is when metathesised and unmetathesised forms are in free variation. This situation is found in Kui (Trans-New-Guinea, Alor), in which the perfective affix *-i* optionally metathesises with a previous /n/ or /l/. Examples are given in (2) below. As currently described, this alternation is a case of free variation.

- (2) Kui metathesis of perfective
- i*
- (Windschuttel & Shiohara 2017: 124f)

<i>alon</i>	+	<i>i</i>	→	<i>aloni</i>	~	<i>aloin</i>	‘write’
<i>gaman</i>	+	<i>i</i>	→	<i>gamani</i>	~	<i>gamain</i>	‘do’
<i>aka:l</i>	+	<i>i</i>	→	<i>aka:li</i>	~	<i>aka:il</i>	‘eat’
<i>tangan</i>	+	<i>i</i>	→	<i>tangani</i>	~	<i>tangain</i>	‘ask’
<i>uban</i>	+	<i>i</i>	→	<i>ubani</i>	~	<i>ubain</i>	‘talk’
<i>gatan</i>	+	<i>i</i>	→	<i>gatani</i>	~	<i>gatain</i>	‘free’

While this data bears some similarities to the Ulwa data discussed above the existence of alternations such as *aloni* and *aloin* ‘write-PERF’ indicates that this is indeed a case of metathesis. That perfective *-i* is a suffix after stems without final /n/ or /l/ indicates that the infixal allomorph in examples such as those in (2) is a result of CV → VC metathesis.

2.2.1 Phonologically conditioned metathesis

Phonologically conditioned metathesis is any process of metathesis which is an automatic result of a phonological environment. Amarasī has a process of phonological metathesis conditioned by vowel-initial enclitics (see Chapter 5).

Processes of phonologically conditioned metathesis are similar to other more familiar phonological processes such as final obstruent devoicing in German. In German a voiced obstruent is devoiced word finally, as can be seen from the data given in (3) below.

- (3) German final obstruent devoicing (Brockhaus 1995: 11f)

Singular		Plural		gloss
<i>Dieb</i>	/di:p/	<i>Diebe</i>	/di:bə/	‘thief’
<i>halb</i>	/halp/	<i>halbe</i>	/halbə/	‘half’
<i>Bund</i>	/bʊnt/	<i>Bunde</i>	/bʊndə/	‘league’
<i>Zweig</i>	/tʃvaik/	<i>Zweige</i>	/tʃvægə/	‘twig’
<i>brav</i>	/bra:f/	<i>brave</i>	/bra:və/	‘well-behaved’
<i>Gas</i>	/ga:s/	<i>Gase</i>	/ga:zə/	‘gas’

The standard (and simplest) analysis of this data is to propose that voiced obstruents are devoiced finally. A simple formal rule for German obstruent devoicing is given in (4) below.²

²German obstruent devoicing involves additional complexities. See (Wiese 1996: 200ff) and Brockhaus (1995) for discussion of the way such complexities have been resolved.

2 Synchronic metathesis from a cross-linguistic perspective

- (4) [+OBSTRUENT] → [-VOICE] / _]σ (Wiese 1996: 201)

In German a phonological process (devoicing) affects a segment in a specific phonological environment. Similarly, in the case of phonologically conditioned metathesis a phonological process (metathesis) occurs in a specific phonological environment.

A simple example of phonological metathesis is provided by Faroese (Germanic, Faroe Islands). In Faroese the neuter form of adjectives is formed by adding the suffix *-t*. When this suffix is added to a stem which ends in /sk/, this cluster metathesises to /ks/. Examples are shown in (5) below. (Such metathesis is not written in Faroese.)

- (5) Faroese sk → ks / _t (Thráinsson et al. 2004: 56)

MASC		FEM		NEUT		
<i>grøn-ur</i>	/kɹø:nɹɔɪ/	<i>grøn</i>	/kɹɔen/	<i>grønt</i>	/kɹɔɛnt/	'green'
<i>fesk-ur</i>	/fɛskɹɔɪ/	<i>fesk</i>	/fɛsk/	<i>fesk-t</i>	/fɛkst/	'fresh'
<i>rask-ur</i>	/ɹaskɹɔɪ/	<i>rask</i>	/ɹask/	<i>rask-t</i>	/ɹakst/	'good'
<i>týsk-ur</i>	/tʰɹɔiskɹɔɪ/	<i>týsk</i>	/tʰɹɔisk/	<i>týsk-t</i>	/tʰɹɔikst/	'German'

This Faroese metathesis is motivated by a phonological constraint against having a cluster of a fricative, plosive, and another plosive in that order. If such a cluster would occur, the fricative and plosive metathesise to prevent it surfacing, and thereby avoid violating the obligatory contour principle. Faroese metathesis of *fesk* /fɛsk/ → *fesk-t* /fɛkst/ is illustrated in (6) below in which *F* = fricative and *P* = plosive. A similar metathesis involving fricatives and plosives is also found in Lithuanian. Hume & Seo (2004) provide a detailed analysis of metathesis in both Faroese and Lithuanian.

- (6) a. C V C C C
 | | | | |
 F V F P P
 | | | | |
 f ε s k t
- b. C V C C C
 | | X | |
 F V F P P
 | | | | |
 f ε s k t
- c. C V C C C
 | | | | |
 F V P F P
 | | | | |
 f ε k s t

Sidamo (Cushitic, Ethiopia) also has phonologically conditioned metathesis. In Sidamo a cluster of an obstruent followed by a nasal is disallowed. If such a cluster is created by the addition of morphology, the obstruent-nasal sequence undergoes metathesis. Examples are given in (7) below, with the first person plural simple perfect suffix.

- (7) Sidamo obstruent+nasal → nasal-obstruent (Kawachi 2007: 46)

stem		1PL-S.PRF1-1PL		
<i>laʔ</i>	+	<i>-n-u-mmo</i>	→	<i>laʔnummo</i> ‘see’
<i>meed</i>	+	<i>-n-u-mmo</i>	→	<i>meendummo</i> ‘shave’
<i>t’ook’</i>	+	<i>-n-u-mmo</i>	→	<i>t’oonk’ummo</i> ‘flee from’
<i>bifʔ</i>	+	<i>-n-u-mmo</i>	→	<i>binʔummo</i> ‘scar’
<i>k’aaf</i>	+	<i>-n-u-mmo</i>	→	<i>k’aanfummo</i> ‘step over/walk’
<i>mif</i>	+	<i>-n-u-mmo</i>	→	<i>minʃummo</i> ‘despise’

Selaru (Austronesian, Maluku) exhibits glide-consonant metathesis. In Selaru, glide-consonant sequences are disallowed. The addition of a consonant-initial suffix thus triggers metathesis with any stem-final glide. Examples are shown in (8) below, with suffixes attached to glide-final stems. The glide-final stems can be contrasted with vowel-final stems in which no metathesis occurs. The glide-final forms, such as *hatw* ‘rock’ occur with a final glide phrase finally or in isolation.

- (8) Selaru GC → CG (Coward & Coward 2000: 22)

<i>tasj</i> + <i>-ke</i>	→	<i>taskje</i>	‘the rope’
<i>hatw</i> + <i>-ke</i>	→	<i>hatkwe</i>	‘the rock’
<i>r-luj</i> + <i>-bo</i>	→	<i>rlubjo</i>	‘they are only spinning’
<i>aj</i> + <i>-ke</i>	→	<i>akje</i>	‘the fire’
<i>tasi</i> + <i>-ke</i>	→	<i>tasike</i>	‘the ocean’
<i>khatu</i> + <i>-ke</i>	→	<i>khatuke</i>	‘the seed’
<i>r-ukui</i> + <i>-bo</i>	→	<i>rukuibo</i>	‘they only cut’
<i>sai</i> + <i>-de</i>	→	<i>saide</i>	‘what?’

In addition to occurring across affix or clitic boundaries, metathesis in Selaru also occurs across word boundaries. Three examples of glide-consonant metathesis across word boundaries are given in (9)–(11) below, in which the underlying (unmetathesised) forms of morphemes are given in the second line. These underlying forms surface without any metathesis in isolation or phrase finally.

- (9) *hinam* *hwahkje desj*
 hina-mw hahj-ke desj
 have-2SG.GEN pig-DEF that
 ‘That is your pork (food).’

2 Synchronic metathesis from a cross-linguistic perspective

- (10) *arawasim* *sjekje* *desj*
 ara-wasi-mj sej-ke desj
 1PX.GEN-have-1PX.GEN house-DEF that
 ‘That is our (exclusive) house.’

- (11) *itjamatke* *mjat* *dje*
 itj-ama-t-ke j-matj de
 1PI.GEN-father-1PI.GEN-DEF 3SG-die already
 ‘Our father is already dead.’ (Coward & Coward 2000: 43)

Coward & Coward (2000) analyse this metathesis as a result of automatic glide spreading. They analyse glides as unassociated elements which spread rightwards to an adjacent C-slot. If there is no following C-slot, they attach to the C-slot to the left. Their analysis is shown in (12) below.

- (12) a. V C C V b. V C C V c. V C C V
 | | | | | | / | | | | / | |
 a s w k e a s w k e a s w k e

Similar examples of glide consonant metathesis are found in a number of languages of the south-eastern Maluku area. Such metathesis has been described for Fordata and Yamdena (Mills 1991: 250), Roma (§2.3.7), Luang (§2.3.5) and Leti (§2.3.6). See Figure 2.1 on page 27 for the locations of these languages.

2.2.2 Morphemically conditioned metathesis

Morphemically conditioned metathesis refers to instances of metathesis which are triggered by the combination of morphemes, but not any new phonological environment created by this combination.

Morphemically conditioned metathesis can be compared to more familiar examples of morphemically conditioned processes, such as German umlaut in the formation of plural nouns. In German, umlaut involves the fronting of a back vowel. One environment which (often) triggers umlaut in German is addition of either of the plural suffixes *-e* /-ə/ or *-er* /-ər/. Examples of German nouns in which umlaut occurs before plural *-e* /-ə/ are given in (13) below.

(13) German umlaut

Singular	Plural	gloss
<i>Fuchs</i> /fʊks/	<i>Füchse</i> /fʏksə/	'fox'
<i>Fuß</i> /fu:s/	<i>Füße</i> /fy:sə/	'foot'
<i>Kopf</i> /kɔpf/	<i>Köpfe</i> /kœpfə/	'head'
<i>Sohn</i> /zo:n/	<i>Söhne</i> /zø:nə/	'son'
<i>Hand</i> /hant/	<i>Hände</i> /hændə/	'hand'
<i>Zahn</i> /tsa:n/	<i>Zähne</i> /tʰɛ:nə/	'tooth'
<i>Maus</i> /maʊs/	<i>Mäuse</i> /mɔʏzə/	'mouse'

It is not a universal feature of German phonology that back vowels are fronted before schwa. This can be seen with other suffixes, such as the plural *-en* /-ən/ which does not trigger umlaut. Two examples are *Dorn* /dɔrn/ 'thorn' → *Dornen* /dɔrnən/ and *Frau* /fraʊ/ 'woman' → *Frauen* /fraʊən/. Similarly, not all words undergo umlaut before plural *-e* /-ə/. Two examples are *Brot* /bro:t/ 'bread' → *Brote* /bro:tə/ 'breads' and *Tag* /ta:k/ 'day' → *Tag* /ta:gə/ 'days'. Such data shows that the vowel of the suffix in examples such as (13) is not a plausible conditioning environment for triggering umlaut.

Such facts lead most analysts to view synchronic umlaut in German as a process separate from that of suffixation. This, for instance, is the approach taken by Wiese (1996: 181ff), who posits that certain lexical entries in German have a floating [+FRONT] feature, the linking of which is triggered partly by morphological features. Wiese (1996) analyses German umlaut as a lexical phonological rule which is triggered in certain morphologically derived environments.

Under such an analysis, German umlaut is a phonological process just like final obstruent devoicing (§2.2.1 page 21). The difference between the two processes is that final obstruent devoicing is triggered by a phonological environment (word finally) while umlaut is triggered by a morphological environment (e.g. plural).

One case of morphemically conditioned metathesis is described by Buckley (2007) for Alsea (Penutian, Oregon). In Alsea certain suffixes trigger sonorant-vowel metathesis while other suffixes do not. One suffix which triggers metathesis is the intransitive imperative suffix *-χ*, while the phonologically identical realis completive suffix *-χ* does not trigger metathesis. Examples are given in (14) below, in which (unmetathesised) stems with realis completive *-χ* are given on the left and metathesised stems with intransitive imperative *-χ* are given on the right.

- (14) Alsea morphemically conditioned metathesis (Buckley 2007: 8f)

	CMPL.RL	INTR.IMP	
‘dances with them’	<i>knáχ-χ</i>	<i>kánχ-χ</i>	‘dance with them!’
‘are lying in bed’	<i>tsnúš-χ</i>	<i>tsúnš-χ</i>	‘lie down!’
‘is hiding’	<i>pjáχ-χ</i>	<i>pájχ-χ</i>	‘hide!’
‘is floating’	<i>tspjút-χ</i>	<i>tspújt-χ</i>	‘float!’

Unlike metathesis in Faroese, Sidamo, or Selaru discussed in §2.2.1, metathesis in Alsea cannot be derived from any new phonological environment created by the concatenation of morphemes – after all, the phonological properties of the realis completive $-\chi$ suffix and intransitive imperative $-\chi$ are identical. Instead, like German umlaut which is triggered by certain suffixes but not by the phonological properties of those suffixes, metathesis in Alsea is morphemically conditioned. Alsea metathesis is discussed in more detail in §B.6.

2.2.3 Morphological metathesis

Morphological metathesis is when metathesis is the only realisation of a morphological category. Morphological metathesis has been reported for about a dozen languages worldwide, of which about half are found in the greater Timor region, where Meto is also spoken. Cases of metathesis in this region are discussed in the next section.

It is important to reiterate here that a unitary analysis of synchronic metathesis is not always possible. Thus, the existence of morphological metathesis in a particular language does not mean that all cases of metathesis in that language should be analysed as morphological processes.

Similarly, a single morphological process (of metathesis of any other kind) in a single language can have different functions in different contexts. One example is the English the suffix $-(e)s$ with allomorphs $/-əz/$, $/-z/$ and $/-s/$. This suffix is a plural marker on nouns and a third person agreement marker on verbs. This situation is found with morphological metathesis in several languages in which metathesis has different morphological functions in different contexts and/or with different word classes. This is the case for Rotuman (§2.3.2.2), Leti (§2.3.6.2), Mambae (§2.3.8.2), Helong (§2.3.9.2), and Amarasi (Chapter 6 and 7)

2.3 Survey of languages with synchronic metathesis

In this section I provide a survey of languages with synchronic metathesis. This discussion is focussed on metathesis in languages of the greater Timor region

2.3 Survey of languages with synchronic metathesis

and/or Austronesian languages. A survey of morphological metathesis in languages beyond this scope is given in Appendix B.

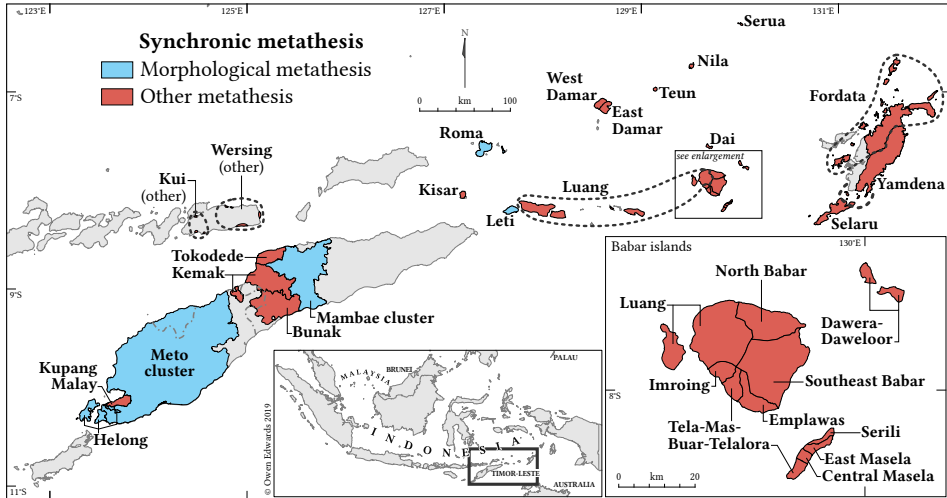

Figure 2.1: Synchronic metathesis in greater Timor

A map of languages in the greater Timor region with synchronic metathesis is given in Figure 2.1, based on Schapper (2015: 135ff), a survey of the literature, and my own fieldwork. This map further marks languages in which metathesis is known to be morphological in at least some environments. *Other metathesis* in Figure 2.1 is used for languages with phonologically or morphemically conditioned metathesis, as well as for languages for which too little data is available to determine the nature of their metathesis.

There are at least five languages of the greater Timor region with morphological metathesis in at least some environments: Leti (§2.3.6), Roma (§2.3.7), Mambae (§2.3.8), Helong (§2.3.9) and the Meto cluster (of which Amarasi is a member). A further twenty or so languages have synchronic metathesis which is phonologically conditioned, morphemically conditioned or not yet unambiguously established as morphological.

I begin my discussion with Kwara'ae (§2.3.1) and Rotuman (§2.3.2), both of which are spoken in the Pacific and outside the greater Timor region. I then discuss cases of synchronic metathesis in the greater Timor region starting with the non-Austronesian languages Wersing (§2.3.3) and Bunak (§2.3.4). After this I discuss synchronic metathesis among Austronesian languages of the greater Timor region moving geographically closer to Meto with each language discussed.

2 Synchronic metathesis from a cross-linguistic perspective

Before proceeding with the discussion it is necessary to clarify two points. Firstly, in some cases I give isolated examples of metathesis of the type $X \rightarrow Y$ (e.g. Rotuman *hosa* \rightarrow *hoas* ‘flower’ on page 36) or $X + Z \rightarrow YZ$ (e.g. Luang *?ernu + la* \rightarrow *?erunla* ‘go down to’ on page 50). In all such cases the form before the arrow is a form which surfaces in certain contexts. Thus, all putative examples of metathesis throughout this section are based on true surface alternations.³

Secondly, in such examples the form before the arrow is the presumed underlying form. The identification of underlying forms follows that of the sources, which in turn is usually based on phonological and morphological analysis. However, I do not usually repeat here the evidence for this analysis. Interested readers should consult the original sources. Again, in all cases the presumed underlying form is a form which surfaces in certain contexts, as discussed above.

2.3.1 Kwara’ae

Metathesis in Kwara’ae has been described by Sohn (1980) and Heinz (2004; 2005). Blevins & Garrett (1998) also present previously unpublished data collected by Andrew Pawley and David Gegeo. Metathesis in Kwara’ae has been analysed as phonologically conditioned (§2.2.1) but it is not restricted to a subset of words with specific phonological properties. Instead nearly every word of the lexicon is affected by metathesis in Kwara’ae.

2.3.1.1 Forms

Metathesis in Kwara’ae is $CV \rightarrow VC$ metathesis. Examples are shown in (15) below. In the literature on Kwara’ae the unmetathesised form (U-form) is called the *citation form* and the metathesised form (M-form) is called the *normal form*. I refer to them with the more iconic terms *U-form* and *M-form*.

(15) $V_1CV_2 \rightarrow V_1V_2C$ (Heinz 2004: 1)

U-form		M-form	
<i>'lo.ʔi</i>	\rightarrow	<i>'loʔi</i>	‘snake’
<i>'bu.ri</i>	\rightarrow	<i>'buir</i>	‘behind’
<i>'bo.re</i>	\rightarrow	<i>'bqer</i>	‘although’

Depending on the length of the word, metathesis in Kwara’ae can occur multiple times. Two examples are given in (16) below. The difference in stress which is

³Readers who find a particular analysis involving metathesis unconvincing should consult the original sources for full discussion and justification.

seen in examples such as *da.ro.ʔa.ni.da* → *'daqr.ʔa.niɛd* 'to share them' is significant and is the phonological conditioning environment by which Heinz (2004) analyses Kwara'ae metathesis.

(16) Kwara'ae multiple metatheses: (Heinz 2004: 2)

U-form	M-form	
<i>'ke.ta, la.ku</i>	→ <i>'kɛat, laɯk</i>	'my height'
<i>da.ro.ʔa, ni.da</i>	→ <i>'daqr.ʔa, niɛd</i>	'to share them'

Metathesis in Kwara'ae often triggers other phonological processes including glide formation, vowel deletion, and umlaut. The different phonological processes with which metathesis is associated are described in §2.3.1.1.1–§2.3.1.1.6 below.

Published descriptions of Kwara'ae report different details for some of these phonological processes. In part these differences may stem from researchers working with different speakers of different ages. However, another likely source of variation is that a single speaker can also use different M-forms depending on speech speed (Patrick Andrews p.c. February 2015).

In addition to the difference in metathesis, U-forms have the labiodental fricative [f] where M-forms have the voiceless glottal fricative [h] (Heinz 2004: 18).

2.3.1.1.1 Glide formation As can be seen from the examples in (15) and (16), when a vowel sequence surfaces in the M-form, the higher vowel is realised as a glide. If the vowels are of equal height, as in *'bo.re* → *'bqer* 'although', the first vowel is realised as a glide. Sohn (1980: 319) likewise states that metathesised forms consist only of one syllable, though he does not give rules for which of the underlying vowels surfaces as a glide.

When a word ends in a vowel sequence, the M-form is derived from the U-form through glide formation alone. This is shown in (17) below:

(17) $V_1V_2 \rightarrow \text{V}_1\text{V}_2$ (Heinz 2004: 13)

U-form	M-form	
<i>ʔo.do.a</i>	→ <i>'ʔo.dqa</i>	'wall'
<i>'do.e</i>	→ <i>'dqe</i>	'great, big'
<i>'ne.i, ri.a</i>	→ <i>'nej, riɛ</i>	'this one'

2.3.1.1.2 Vowel deletion When a word ends in $V_1V_2CV_3\#$, and V_2 and V_3 are of the same quality, the first two vowels undergo glide formation and the final vowel is deleted. This is shown in (18) below.

2 Synchronic metathesis from a cross-linguistic perspective

(18) $V_{1\alpha}V_{2\beta}CV_{3\beta} \rightarrow V_{1\alpha}V_{2\beta}C$ (Heinz 2004: 27-28)

U-form	M-form	
<i>fu.'i.ri</i>	→	' <i>hʷir</i> 'that'
<i>bi.'a.la</i>	→	' <i>bʲial</i> 'smoke'

2.3.1.1.3 Vowel shift The low central vowel /a/ has a different quality after metathesis when the preceding vowel is high. It is described as schwa [ə] by Sohn (1980: 315), while Heinz (2004: 23) describes it as varying between [ɛ] and [ə] after /i/ and as [ʌ] after /u/. Examples are given in (19) below.

(19) $V[+HI]Ca \rightarrow VəC:$ (Heinz 2004: 23)

U-form	M-form	
<i>a.'si.la</i>	→	' <i>a, sʲɛl</i> ~ ' <i>a, sʲəɫ</i> 'sweet'
<i>fa.'ʔu.ta</i>	→	' <i>ha, ʔʌt</i> 'which, how, why'

Likewise, certain combinations of vowel “fuse” into a single vowel rather than a sequence of glide and vowel. Sohn (1980: 316) gives a rule in which /oi/ is realised as [ø̣], /oe/ as [œ̣], /ae/ as [æ̣] and /ai/ is realised as either [ɛi] or [ɛ̣]. This is similar to the processes of umlaut which have operated in the Germanic languages (§2.4.1).

(20) $V_{\alpha}CV_{\beta} \rightarrow V_{\alpha\beta}C$ (Sohn 1980: 316)

U-form	M-form	
<i>moli</i>	→	' <i>mø̣l</i> 'lemon'
<i>asofe</i>	→	' <i>asœ̣f</i> 'rat'
<i>maʔetaʔeelo</i>	→	' <i>mæ̣ʔ.tæ̣ʔ.eol</i> 'doorway'
<i>dami</i>	→	' <i>dɛim</i> ~ ' <i>dɛ̣m</i> 'gum'

Heinz (2004) does not report front rounded vowels, but he does report a similar process when the first vowel of the sequence is /a/. He states that “[...] there is some free variation: if $V_2 = [e], [i]$ or $[u]$, sometimes the vowel combination can be realized as a single vowel.” He only gives examples of /ae/ → [æ̣], /ai/ → [ɛ̣] and /au/ → [ọ].

(21) $V_{\alpha}CV_{\beta} \rightarrow V_{\alpha\beta}C$ (Heinz 2004: 24)

U-form	M-form	
<i>'sa.te</i>	→	' <i>sæ̣t</i> ~ ' <i>sạt</i> 'chin, beard'
<i>'ma.ʔi</i>	→	' <i>mẹʔ</i> ~ ' <i>mạiʔ</i> 'come'
<i>li.'ma.ku</i>	→	' <i>li, mọk</i> ~ ' <i>li.mạʷk</i> 'my hand'

2.3.1.1.4 Long vowels When the penultimate and final vowel of the U-form are identical, Sohn (1980), Pawley and Gegeo (cited in Blevins & Garrett 1998) and Heinz (2004) all transcribe the vowel of the M-form as half-long, using the symbol [·]. Other descriptions of Kwara'ae, such as, Simons (1977) and Tryon & Hackman (1983) do not transcribe such vowels as long.

(22) $V_{\alpha}CV_{\alpha} \rightarrow V_{\alpha}·C$ (Heinz 2004: 25)

U-form		M-form	
'ki.ni	→	'ki·n	'female'
'ma.na	→	'ma·n	'her/his eye'
'mo.ko	→	'mɔ·k	'smell'

However, as noted by Heinz (2004: 25), no author justifies the use of this half-long mark, with Heinz indicating that this is a point for further research. An instrumental phonetic study of Kwara'ae vowels would probably settle the matter.⁴ It is also possible that such vowels are long in some contexts and short in others, depending on variables such as phrasal stress and the rate of speech.

2.3.1.1.5 Voiceless vowels Optional voiceless vowels also occur after certain consonants in the U-form. Heinz (2004: 19) reports such vowels after the consonants [ʔ], [h], [l] and [s]. These vowels do not count as vowels for the purposes of stress assignment, with stress falling on the penultimate vowel, not counting final voiceless vowels. After word-final stops, voiceless vowels do not occur, though the final stop is often strongly aspirated.

(23) $V_1CV_2 \rightarrow V_1V_2C^*V_2$ (Heinz 2004: 19)

U-form		M-form	
'ma.ʔu	→	'maʔ·ʔu	'fear'
'ʔa.fe	→	'ʔaɛhɛ	'wife'
'bu.su	→	'bu·sɯ	'to burst'
'ro.do	→	'rɔ·dʰ	'night'
'naʔ.ku	→	'naʔkʰ	'I'

Pawley and Gegeo (cited in Blevins & Garrett 1998) describe voiceless vowels in a wider variety of contexts than is described by Heinz (2004). According to

⁴For Amarasi I carried out an instrumental study of vowel length in which I showed that there is a statistically significant difference in length between the penultimate vowel of a U-form with identical penultimate and final vowels and the final vowel of the M-form of such words. I analyse this difference in length as being due to the M-forms containing a sequence of two identical vowels. (see §3.2.1.4.3 and §4.2.2.3).

2 Synchronic metathesis from a cross-linguistic perspective

Pawley and Gegeo, a final voiceless vowel is the usual realisation of words in the M-form. Such vowels only do not occur when there is a word-final nasal or if the resulting diphthong is a sequence of a high vowel followed by a non-high vowel.

(24) $V_1CV_2 \rightarrow V_1V_2CV_2$ (Pawley and Gegeo in Blevins & Garrett 1998: 530)

U-form		M-form	
'fusi	→	huis̥i	'cat'
'kado	→	kaod̥o	'thin'
'oso	→	os̥o	'lie'

According to Heinz (2004: 20), the differences between his data and the data cited by Blevins & Garrett (1998) likely comes from working with speakers of different generations. Heinz states: “[...] it’s reasonable that her [Kwara’ae consultant’s] speech pattern reflects another stage in the decline of the final vowel.”

Table 2.1: Kwara’ae metathesis

$V_1 \downarrow$	i	e	a	o	u	$\leftarrow V_2$
i	i̇	–	jɛ, jə	jo	ju	
e	ej	ɛ̇	ɛa	ɛo	ew	
a	aj, ej, ė, (ɛj, ɛ̇)	æ̇, aɛ	ȧ	aɔ	aw, ȯ	
o	oj, (ȯ)	oɛ, we, (œ̇)	oɔ	ɔ̇	ow	
u	wi	wɛ	wɔ, (wə)	–	u̇	

2.3.1.1.6 Summary The processes with which metathesis in Kwara’ae is associated include glide formation, umlaut, and vowel deletion. The effects of deriving the M-form on the first and second vowels of the U-form in Kwara’ae are given in Table 2.1. This table is adapted from (Heinz 2004: 26) with qualities reported by Sohn (1980) included in brackets. The symbols used by Heinz for the high vowel glides: [ɥ] and [ɨ], have been replaced with the symbols [w] and [j].

2.3.1.2 Distribution of metathesis

U-forms and M-forms in Kwara’ae belong to different speech registers. In everyday normal speech the M-form is used, while the U-form is used in traditional songs, for clarification (Heinz 2004: 3), and when calling out. Watson-Gegeo & Gegeo (1986: 19) report that calling out has three main uses in Kwara’ae discourse:

2.3 Survey of languages with synchronic metathesis

First, people call out for practical reasons in running a household, such as to locate a missing person or to bring a family member home for a meal. Secondly, a Kwara'ae man or woman working in the bush and hearing someone working nearby but out of sight will call out to seek identification of the other person. Thirdly, people call out from house to house, or as someone passes on the path, as a strictly social activity. They ask polite questions, or joke, tease, and engage in pleasant banter. (Watson-Gegeo & Gegeo 1986)

In addition to the use of unmetathesised forms, calling out is marked by a special intonation contour and certain emphatic particles. Two examples of Kwara'ae calling out are given in (25) below. Note also the extra length on the final syllable of the second form of 'father' in example (25a) as well as the particle *ku* in (25b). These two features are also distinctive of calling out.

- (25) Kwara'ae calling out: (Watson-Gegeo & Gegeo 1986: 24,21)
- a. *maʔ!* *maʔa:!*
father\M father\U
'Dad! Da-ad!'
- b. *Sala!* *Sal!* *Sal* *ku!* *lae mai? tua hain* *Mosa!*
Sala\U Sala\M Sala\M PART go here stay with:3SG.POSS Mosa\U
'Sala! Sala! Hey, Sala! Come here and babysit Mosa!'

The use of different forms in different speech registers is confirmed by Patrick Andrews (p.c. February 2015) who reports that (among other uses) the unmetathesised forms are used when making a point to a child or to emphasise words in a speech. He compares the use of the metathesised forms to that of English contractions, such as *couldn't* from *could not*, with the former being the everyday form and the latter being used in special circumstances. This difference in distribution suggests that different forms are used in different (discourse) pragmatic contexts.

Heinz (2004) proposes an analysis of Kwara'ae metathesis framed within Optimality Theory in which metathesis is conditioned by stress. Under this analysis, metathesis in Kwara'ae is a response to the need to make stressed syllables heavy, with a vowel-glide combination counting as a heavy syllable. This analysis is discussed in more detail in §4.4.1.2.

Given that different forms are used in different speech registers, an analysis of Kwara'ae metathesis as being driven by stress would predict that different registers have different stress rules. While it is likely that such a hypothesis would be borne out, to the best of my knowledge this has not yet been demonstrated.

2 Synchronic metathesis from a cross-linguistic perspective

Nearly every word in Kwara'ae is affected by metathesis. If it is the case that different speech registers have different stress patterns, which in turn drives the metathesis, Kwara'ae has (rampant) phonologically conditioned metathesis though the phonological conditions triggering metathesis are themselves driven by the discourse.

2.3.2 Rotuman

Rotuman has perhaps the most famous case of morphological metathesis. Rotuman is an Austronesian Oceanic language spoken on Rotuma island in the Pacific Ocean located about 480 kilometres north of the main islands of Fiji. Metathesis occurs in multiple environments in Rotuman. In some cases metathesis is phonologically conditioned (§2.2.1), in some cases it is morphemically conditioned (§2.2.2), and in some cases it is morphological (§2.2.3).

Rotuman was first described by Churchward (1940) who provides a grammar and dictionary of the language. Churchward also published several Rotuman texts between 1937–39 in the journal *Oceania* which were reprinted in one volume as Churchward (1939). Both Besnier (1987) and Vamarasi (2002) also present descriptions of Rotuman based on their own fieldwork. Each of these descriptions differs in details. This may be partly because the authors worked with different speakers at different times and may also be partly because they use different terminology to describe the same phenomena.

2.3.2.1 Forms

Each word in Rotuman has two forms, which I call the U-form and M-form. The traditional names coined by Churchward (1940) are the *complete phase* for the U-form and the *incomplete phase* for the M-form. The U-form is historically more conservative than the M-form.

Churchward (1940) identifies four phonological processes which derive the M-form from the U-form. These processes are vowel deletion (a.k.a apocope, truncation, or subtraction), umlaut, metathesis, and vowel shortening. There are also words which do not have two distinct forms. Which process applies depends on the phonological shape of the U-form.

2.3.2.1.1 Vowel shortening/diphthongisation For words which end in a vowel sequence in which the vowels are non-identical, Churchward (1940: 85) describes the M-form as being formed by shortening the initial vowel of the sequence. Examples are given in (26) below.

2.3 Survey of languages with synchronic metathesis

(26) Rotuman $V_{\alpha}V_{\beta} \rightarrow \check{V}_{\alpha}V_{\beta}$ (Churchward 1940: 85)

U-form		M-form	
<i>pupui</i>	→	<i>pupūi</i>	‘floor’
<i>ʔesʔao</i>	→	<i>ʔesʔāo</i>	‘useful’
<i>lelei</i>	→	<i>lelēi</i>	‘good’
<i>foʔou</i>	→	<i>foʔōu</i>	‘new’

Vamarasi (2002) describes a process of diphthongisation in which the less sonorous vowel becomes a glide. This glide formation may be either a further development of Churchward’s shortened vowels, or it may be that a single phenomenon was perceived and described differently by each of these authors.

(27) Rotuman $V_{\alpha}V_{\beta} \rightarrow \check{V}_{\alpha}V_{\beta} \sim V_{\alpha}\check{V}_{\beta}$ Vamarasi (2002: 4,7–9)

U-form		M-form	
<i>lio</i>	→	<i>ljo</i>	‘voice’
<i>fau</i>	→	<i>faw</i>	‘year’
<i>fui</i>	→	<i>fuj</i>	‘piece of garland’
<i>fvi</i>	→	<i>fɔj</i>	‘chop down’
<i>momoe</i>	→	<i>momoɛ</i>	‘k.o. tree’

According to Besnier (1987: 210) the vowel sequences which diphthongise are those in which the second vowel is /a/ as well as sequences of a high vowel followed by /o/. Besnier also reports that /a/ is realised as [ɔ] after a glide derived from one of the high-front vowels.

(28) Rotuman $V_{\alpha}V_{\beta} \rightarrow \check{V}_{\alpha}V_{\beta}$ (Besnier 1987: 210)

U-form		M-form	
<i>ʔea</i>	→	<i>ʔja</i>	‘to say’
<i>foa</i>	→	<i>fwa</i>	‘coconut scraper’
<i>kia</i>	→	<i>kjɔ</i>	‘neck’
<i>sua</i>	→	<i>swɔ</i>	‘shoot (of a plant)’

2.3.2.1.2 Metathesis When the U-form ends in VCV and the penultimate vowel is higher than the final vowel, the M-form is derived by final consonant-vowel metathesis. Examples are given in (29) below.

2 Synchronic metathesis from a cross-linguistic perspective

- (29) Rotuman $V_1CV_2 \rightarrow V_1V_2C$ (Churchward 1940: 14)

U-form		M-form	
<i>pure</i>	→	<i>puer</i>	‘to rule, decide’
<i>hosa</i>	→	<i>hoas</i>	‘flower’
<i>tiko</i>	→	<i>tiok</i>	‘flesh’
<i>pepa</i>	→	<i>peap</i>	‘paper’

Both Vamarasi (2002) and Besnier (1987) report that after metathesis the penultimate vowel becomes a glide; /u/ and /o/ become [w] while /i/ and /e/ become [j]. Examples are given in (30) below.

- (30) Rotuman $V_1CV_2 \rightarrow \underset{V}{V}_1V_2C$ (Vamarasi 2002: 3)

U-form		M-form	
<i>pure</i>	→	<i>pw^{er}</i>	‘rule’
<i>fupa</i>	→	<i>fw^{ap}</i>	‘to distribute’
<i>?iko</i>	→	<i>?j^{ok}</i>	‘thrust’

Besnier (1987: 208) reports that when the penultimate vowel is a high vowel, the final vowel becomes [ɔ] after metathesis. Otherwise, the final vowel retains its original quality. Examples are given in (31) below.

- (31) Rotuman $V_1CV_2 \rightarrow \underset{V}{V}_1V_2C$ (Besnier 1987: 208)

U-form		M-form	
<i>tife</i>	→	<i>tj^{ɔf}</i>	‘pearl shell’
<i>pi^fa</i>	→	<i>pj^{ɔf}</i>	‘rat’
<i>hu^ɲe</i>	→	<i>hw^ɔɲ</i>	‘to breathe’
<i>puka</i>	→	<i>pw^ɔk</i>	‘k.o. creeper’
<i>hepa</i>	→	<i>hj^{ap}</i>	‘broad’
<i>lo^ŋa</i>	→	<i>lw^{an}</i>	‘towards the interior of the island’

It is not entirely clear whether the diphthongisation after metathesis reported by Besnier (1987) and Vamarasi (2002) is a recent development or whether it was also present while Churchward worked on Rotuman.

On the one hand, it is clear from the detailed account of Rotuman phonetics given by Churchward (1940: 64–84) that he was an excellent phonetician. Given his identification of shortened vowels in the derivation of M-forms (§2.3.2.1.1), it seems likely that if diphthongisation (or shortened vowels) were present after metathesis he would have reported it.

On the other hand, Churchward (1940: 86) states “the stress seems to be levelled out, so to speak, in the inc[omplete] phase. Thus: *fora* becomes *foar*, which

is pronounced almost, though perhaps not quite, as one syllable, the stress being evenly distributed [...]" This statement perhaps indicates that diphthongisation was an optional feature of Rotuman metathesised forms in Churchward's day.

2.3.2.1.3 Umlaut When the penultimate vowel is a back vowel and the final vowel a front vowel, the M-form is derived via umlaut of the penultimate vowel so long as this vowel is not higher than the final vowel.

Churchward (1940: 79) reports that /u/ becomes [y], /o/ becomes [œ] when the final vowel is /e/, and that /o/ becomes [ø] when the final vowel is /i/.⁵ He also transcribes the outcome of umlauted /ɒ/ as <â>, describing it as "[...] a little wider [lower] than a in 'cat' [...] but differs from it in containing just a suggestion of the sound of u in 'cut' or 'but.'" I interpret Churchward's <â> as a low front rounded vowel [œ].

Examples of Rotuman umlaut are given in (32) below, which also gives hypothetical intermediate forms showing the way such umlaut probably developed from metathesis. In Kwara'ae words containing some of the vowel combinations shown in (32) have M-forms which vary between displaying metathesis and umlaut (§2.3.1.1.3).

(32) V[+RND]CV[+FR] → V[+RND,+FR]C (Churchward 1940: 79-80)

U-form		M-form	
<i>ʔuli</i>	> *ʔuil	> <i>ʔyl</i>	'skin'
<i>mori</i>	> *moir	> <i>mør</i>	'orange (fruit)'
<i>mose</i>	> *moes	> <i>mæs</i>	'to sleep'
<i>ʔɒfi</i>	> *ʔɒif	> <i>ʔæf</i>	'to bite'

Vamarasi (2002) reports that /o/ becomes [ø] under umlaut, /u/ becomes [y] and /ɒ/ becomes the lower mid-front-rounded [œ]. Examples are given in (33)

⁵Churchward (1940) describes the vowel in the M-form of oCe# final words (e.g. *mose* → *mæs* 'sleep') as "[...] similar to the wider German ö, as in *gespött*, and to the sound of *eu* in the French *jeune*." He contrasts "normal ö" (which "[...] arises in place of normal *o* when a following *e* is elided") with so-called "narrow ö" (arising "[...] in place of narrow *o* when a following *i* is elided") which is described as "[...] similar to the narrower German ö, as in *schön*, and to the sound of *eu* in the French *peu*." I interpret "normal ö" as a mid-low front-rounded vowel [œ] and "narrow ö" as a mid-high front-rounded vowel [ø].

2 Synchronic metathesis from a cross-linguistic perspective

(33) Rotuman $V[+BA]CV[+FR] \rightarrow V[+FR]C$ (Vamarasi 2002: 3)

U-form		M-form	
<i>futi</i>	→	<i>fyt</i>	‘to pull’
<i>mose</i>	→	<i>møs</i>	‘to sleep’
<i>pɔri</i>	→	<i>pæri</i>	‘banana’

Besnier’s data agrees with Vamarasi on the outcome of /o/ and /u/, though he reports that /ɔ/ (equivalent to Churchward’s and Vamarasi’s /ɒ/) becomes either [ɛ] or [æ] in free variation in certain words. Examples are given in (34) below.

(34) Rotuman $V[+BA]CV[+FR] \rightarrow V[+FR]C$ (Besnier 1987: 209)

U-form		M-form	
<i>pɔti</i>	→	<i>pɛt</i>	‘scar’
<i>hɔʔi</i>	→	<i>hɛʔ</i>	‘to pull’
<i>pɔni</i>	→	<i>pɛn</i>	‘paint’

All authors agree that umlaut of /u/ or /o/ spreads leftwards to identical vowels. Examples are given in (35) below

(35) Rotuman umlaut spreading: (Churchward 1940: 79f)

U-form	→	M-form	
<i>furfuruki</i>	→	<i>fyrfyryk</i>	‘pimple’
<i>roromi</i>	→	<i>rørøm</i>	‘unexpectedly’
<i>popore</i>	→	<i>pœpær</i>	‘to dash, dart’

2.3.2.1.4 Apocope In all situations not covered by diphthongisation, metathesis, or umlaut, the M-form is derived by deleting the final vowel of the U-form. This includes when each vowel is identical and when the penultimate vowel is lower than a final back vowel. Examples are shown in (36) below.

(36) Rotuman $VCV \rightarrow VC$ (Churchward 1940: 13)

U-form		M-form	
<i>haŋa</i>	→	<i>haŋ</i>	‘to feed’
<i>hɔŋu</i>	→	<i>hɔŋ</i>	‘to awaken’
<i>læʔe</i>	→	<i>læʔ</i>	‘coral’
<i>tokiri</i>	→	<i>tokir</i>	‘to roll’
<i>hoto</i>	→	<i>hot</i>	‘to jump’
<i>heleʔu</i>	→	<i>heleʔ</i>	‘to arrive’

The lack of overt metathesis in such examples is comparable to the Amarasi data in which words with a certain phonotactic shape form their M-form by surface vowel deletion and/or consonant deletion (Chapter 4).

2.3.2.1.5 No change Words ending in two identical vowels do not usually have distinct U-forms and M-forms according to Churchward (1940: 85), except before certain suffixes in which case the final vowel of U-form is lengthened. Examples are given in (37) below.

(37) Rotuman $V_{\alpha}V_{\alpha} \rightarrow V_{\alpha}V_{\alpha}$ (Churchward 1940: 85)

U-form		M-form	
<i>rii</i>	→	<i>rii</i>	‘house’
<i>ree</i>	→	<i>ree</i>	‘to do’

Besnier (1987) reports that when the sequence of two identical vowels is /aa/, the M-form is formed by deleting the final vowel. In other situations Besnier reports no difference in the two forms. Examples are given in (38) below.

(38) Rotuman /aa/ → /a/ (Besnier 1987: 212)

U-form		M-form	
<i>?aa</i>	→	<i>?a</i>	‘bite’
<i>ree</i>	→	<i>ree</i>	‘do’
<i>luu</i>	→	<i>luu</i>	‘rope’

2.3.2.1.6 Summary of forms The ways in which the Rotuman M-form is derived from the U-form for CV# final words are shown in Table 2.2. In most cases the M-form is one syllable shorter than the U-form, the main exceptions being word-final sequences of identical vowels and Churchward’s metathesised forms.

2.3.2.2 Distribution of metathesis

Three uses of M-forms can be identified in Rotuman: phonologically conditioned, morphemically conditioned, and morphological. Each is discussed in turn.

2.3.2.2.1 Phonologically conditioned M-forms Hale & Kissonock (1998) show that, with two exceptions, the U-form is used before suffixes and enclitics which are monosyllabic or non-syllabic, while the M-form is used before polysyllabic suffixes and enclitics.

2 Synchronic metathesis from a cross-linguistic perspective

Table 2.2: Medial vowels of Rotuman U-forms and M-forms

V ₁ ↓	Churchward (1940)					Vamarasi (2002)					Besnier (1987)					←V ₂
	i	e	a	o	u	i	e	a	o	u	i	e	a	o	u	
i	i	ie	ia	io	i	i	jɛ	ja	jɔ	i	i	jɔ	jɔ	jo	i	i
e	e	e	ea	e	e	ɛ	ɛ	ja	ɛ	ɛ	e	e	ja	e	e	e
a	æ	æ	a	a	ɒ	œ	æ	a	a	ɒ	ɛ	ɛ	a	a	ɔ	a
o	ø	œ	oa	o	o	ø	ø	wa	ɔ	ɔ	ø	ø	wa	o	o	o
u	y	ue	ua	uo	u	y	wɛ	wa	wɔ	u	y	wɔ	wɔ	wo	u	u

An example of the U-form before a monosyllabic suffix is given in (39) and an example before a non-syllabic suffix is given in (40). An example of the M-form before a disyllabic affix is given in (41) and an example before a trisyllabic enclitic is given in (42). These examples are taken from Hale & Kisson (1998: 120f)

- (39) *puʔa + ŋa → puʔa-ŋa*
 be greedy NMLZ greedy\U-NMLZ
 ‘greed’
- (40) *vaka + t → vaka-t*
 canoe SG canoe\U-SG
 ‘a canoe’
- (41) *furi + ʔian → fyr-ʔian*
 turn INGRESSIVE turn\M-INGRESSIVE
 ‘start turning’
- (42) *vaka + teʔisi → vak=teʔisi*
 canoe this canoe\M=this
 ‘this canoe’

Similarly, each non-final word in the noun phrase occurs in the M-form. That is, the M-form is used when a noun is modified; it is used to mark the presence of a dependent modifier. This is also a function of metathesis in Leti (§2.3.6) and Amarasi (Chapter 6).

Compare the phrases in (43) and (44) below, from Churchward (1940: 14). Each phrase consists of the noun *famori* ‘people’ followed by the adjective *feʔeni* ‘zealous’. In (43) the noun *famori* ‘people’ is in the U-form and the adjective has a predicative reading, as illustrated in (45). In (44) the noun *famør* ‘people’ is in

the M-form, and the adjective has an attributive meaning, as illustrated in (46). (The use of the M-form of the adjective in (43) and (45) is discussed in §2.3.2.2.3 below.)

(43) *famori feʔen*
 people\U zealous\M
 ‘The people are zealous.’

(44) *famør feʔeni*
 people\M zealous\U
 ‘(The) zealous people.’

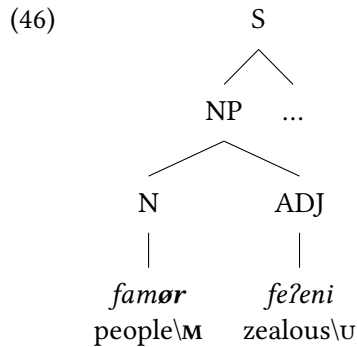
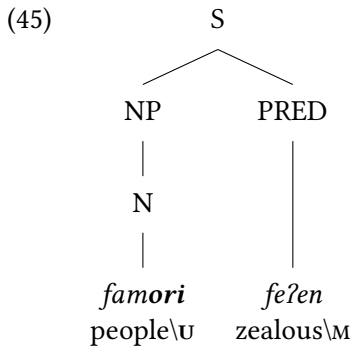

The generalisation identified by Hale & Kissock (1998) is that the M-form is (mostly) used before polysyllabic modifiers, while the U-form is used elsewhere. This generalisation is the basis for the analysis of McCarthy (2000) under the frameworks of prosodic morphology and Optimality Theory. This analysis is discussed in more detail in §4.4.1.1.

2.3.2.2.2 Morphemically conditioned M-forms As acknowledged by Hale & Kissock (1998), there are two exceptions to their generalisation that the M-form occurs before polysyllabic suffixes, enclitics, and modifiers.

The first exception is the monosyllabic singular marker *-ta*. Before this article M-forms occur, despite the fact that this suffix is monosyllabic. An example of is given in (47) below.

(47) *mori + ta* → *mør-ta* **mori-ta*
 orange SG orange\M-SG
 ‘the orange’

(Vamarasi 2002: 14)

The second exception is that M-forms of nouns are used without any affix or enclitic for plural indefinite, while the U-form is used for plural definite. Examples are given in (48) and (49) from Churchward (1940: 15)

2 Synchronic metathesis from a cross-linguistic perspective

(48) *famori* ?ea
 people\U say
 ‘The people say.’

(49) *famør* ?ea
 people\M say
 ‘Some people say.’

Hale & Kissonck (1998: 121f) analyse these exceptions by positing zero affixes with moraic weight. Their analysis of the exceptional forms of *vaka/vak* ‘canoe’ is shown in (50) below.⁶

(50) Rotuman exceptional M-forms: (Hale & Kissonck 1998: 122)

<i>vaka</i>	/vaka + \emptyset_{PL} + \emptyset_{DEF} /	‘the canoes’
<i>vak ta</i>	/vaka + ta + \emptyset_{DEF} /	‘the one canoe’ (i.e. ‘the canoe’)
<i>vaka-t</i>	/vaka + ta/	‘a/one canoe’

An analysis involving multiple null suffixes with moraic weight is not particularly convincing as an appropriate synchronic analysis of the Rotuman data. Instead, given that U-forms are normally used before monosyllabic suffixes, uses of the M-form before the singular suffix *-ta* is better analysed as morphemically conditioned and use of the M-forms to mark an indefinite plural is better analysed as a morphological use of M-forms.

2.3.2.2.3 Morphological M-forms In addition to phonologically conditioned M-forms before polysyllabic modifiers and morphemically conditioned M-forms before the singular suffix *-ta*, morphological M-forms also occur as the only phonological realisation of a semantic difference. A number of different morphological uses of M-forms can be identified in Rotuman.

Firstly, as mentioned above, U-forms and M-forms are used in noun phrases to mark definiteness. When the final word of the noun phrase is in the U-form it is definite plural, when the final word is in the M-form it is indefinite. Examples (48) and (49) above are repeated as (51) and (52) below to illustrate.

(51) *famori* ?ea
 people\U say
 ‘The people say.’

(52) *famør* ?ea
 people\M say
 ‘Some people say.’

⁶I cannot find a clear explanation in Hale & Kissonck (1998) for why the noun *vaka* surfaces in the U-form when followed by the two suffixes \emptyset_{PL} and \emptyset_{DEF} . If I understand the analysis correctly, each null suffix should have moraic weight, with this combination of two suffixes being poly-moraic (polysyllabic) and thus triggering the M-form.

Secondly, verbs and predicative adjectives normally occur in the M-form. This has already been seen in (43) above, repeated as (53) below. This is due to “[...] the general rule that, except in certain circumstances, a verb – or an adjective used as a verb – is used in its incomplete phase [M-form]” (Churchward 1940: 15). This is similar to Amarasi in which the default form of verbs is the M-form (see §7.3).

- (53) *famori fe?en*
 people\U zealous\M
 ‘The people are zealous.’

One environment in which verbs and adjectives occur in the U-form is to mark “positiveness, finality or (in questions) the desire to be positive or certain” (Churchward 1940: 88). This function also occurs with a number of other word classes including locative pronouns, some temporal nouns, demonstratives, and interrogative pronouns. Two examples of Rotuman U-form questions with corresponding answers are given in (54) and (55) below.

Rotuman U-form questions:

(Churchward 1940: 95)

- | | | |
|------|--|--|
| (54) | a. <i>?e una</i>
LOC middle\U
‘In the middle, did you say?’ | b. <i>?e uan</i>
LOC middle\M
‘In the middle.’ |
| (55) | a. <i>?e fap?ana</i>
LOC three.days\U
‘In three days time, did you say?’ | b. <i>?e fap?an</i>
LOC three.days\M
‘In three days time.’ |

Churchward (1940: 95) also gives the imperative *leume!* ‘come\U’ which is “freq[ueently] used when one or more calls of *leum!* [‘come\M’] fail to move the person summoned” as another example of this “positiveness” use.

The use of U-forms in Rotuman with verbs (and some other word classes) to mark “positiveness” is comparable the use of Amarasi U-forms on verbs (and some other word classes) to mark discourse structures. In Amarasi, such U-forms mark an unresolved state/event which requires another clause for resolution (Chapter 7). In particular, in both Rotuman and Amarasi, verbal U-forms are used in questions (§7.10).

Finally, Churchward (1940: 88) states that for verbs ending in a pronominal suffix, the U-form is used to mark the completive tense, though he does not give

2 Synchronic metathesis from a cross-linguistic perspective

examples. This use of verbal U-forms is similar to Helong (§2.3.9.2.2) in which U-forms mark the perfective aspect.

2.3.3 Wersing

Wersing (Trans-New Guinea, Alor) has a process of synchronic consonant-vowel metathesis. Based on current data, Wersing appears to have phonologically conditioned metathesis, though there are indications that it may also have morphemically conditioned metathesis.

Schapper & Hendery (2014), describing the Pureman dialect, report that the final CV sequence of a stem metathesises to VC before either the realis suffix *-a* or the specific enclitic *=a*. Examples are shown in (56) and (57) below, in which the second line shows the underlying forms. In each example the corresponding unmetathesised forms **gə-tati-a* and **saku=a* are ungrammatical

- | | | | |
|------|-----------------------------------|------|--------------------|
| (56) | <i>ganin wetin gə-tait-a</i> | (57) | <i>hans sauk=a</i> |
| | <i>ganin wetin g-tati-a</i> | | <i>hans saku=a</i> |
| | 3CLSF:HUM five 3-stand-RL | | Hans elder=SPEC |
| | ‘There are five people standing.’ | | ‘Mr. Hans’ |

Banamtuan (2018), describing the Kolana dialect, presents a greater range of data for Wersing metathesis. Based on Banamtuan’s description, final CV → VC metathesis is obligatory for most stems of a certain shape before a morpheme beginning with a vowel. Banamtuan describes metathesis as only affecting words in which the penultimate and final vowels are identical or words in which the final vowel is a high vowel.

Thus, in (58) below the noun *bolu* ‘trumpet shell’ occurs unmetathesised before a consonant-initial verb while in (59) the same noun occurs metathesised before a vowel-initial verb.

- | | |
|------|---|
| (58) | <i>ne-pa g-wai bolu lewena</i> |
| | 1SG-father 3-go trumpet.shell\U look.for |
| | ‘My father goes to look for trumpet shell.’ |
| (59) | <i>neta boul usasi</i> |
| | 1SG trumpet.shell\M blow |
| | ‘I blow a trumpet.’ |

Similarly, in (60) the third person pronoun *gadi* occurs unmetathesised before consonant-initial *wuinj* ‘catch’ but metathesised in (61) before the vowel-initial word *areinj* ‘bury’.

- (60) *pulis gadi wuiŋ*
 police 3SG\U catch
 ‘The police arrested him.’
- (61) *ni-wai lwen a-miŋ gaid areiŋ*
 1PX-go place DIST-LOC 3SG\M bury
 ‘We went to bury him there.’

Unmetathesised forms do not occur before vowel-initial morphemes, as shown in (62a) below in which it is ungrammatical for unmetathesised *nadi* ‘1SG’ to occur before the vowel-initial demonstrative *o-ba*. Instead, the metathesised form must be used as shown in (62b).

- (62) a. **nadi o-ba Wersiŋ ge-aniŋ*
 1SG\U PROX-DEM Wersing 3-person
- b. *naid o-ba Wersiŋ ge-aniŋ*
 1SG\M PROX-DEM Wersing 3-person
 ‘I am a Wersing person.’

Similarly, metathesised forms cannot usually be used before consonant-initial morphemes, as shown in (63a) in which it is ungrammatical for metathesised *naid* ‘1SG’ to occur before the demonstrative *ba*. Instead, the unmetathesised form *nadi* must be used, as shown in (63b).

- (63) a. **naid ba Wersiŋ ge-anin obo*
 1SG\M DEM Wersing 3-person this
- b. *nadi ba Wersiŋ ge-anin obo*
 1SG\U DEM Wersing 3-person this
 ‘I am a Wersing person.’

Metathesis in Wersing apparently does not affect stems which end in /a/ with a different penultimate vowel. Thus, the 1SG pronoun *neta* and 1PX pronoun *nita* are reported to only have a single (unmetathesised) form. However, words in which both the penultimate and final vowels are /a/ do have metathesised forms. Banamtuan (2018) gives the example of *kana* → *kaan* ‘already, PFV’.

Metathesis in Wersing thus appears to be an automatic process which affects most CV# final words when they occur before another vowel. This is similar

2 Synchronic metathesis from a cross-linguistic perspective

to Amarasi metathesis before vowel-initial enclitics which can be analysed as a phonologically conditioned process (see Chapter 5).⁷

Finally, Banamtuan (2018) also shows that metathesis occurs in other environments in Wersing. Thus, the word *akumi* ‘group’ is obligatorily metathesised before the quantifiers *ba* and *tme* [təme], as shown in (64) and (65) respectively.

- | | | |
|------|---|---|
| (64) | a. <i>aniŋ akuim ba</i>
person group\M one
‘The group of people.’ | b. * <i>aniŋ akumi ba</i>
person group\U one
‘(The group of people.)’ |
| (65) | a. <i>g-niŋ akuim tme</i>
3-person group\M some
‘Some group of people.’ | b. * <i>g-niŋ akumi tme</i>
3-person group\U some
‘(Some group of people.)’ |

Similarly, *lomu* → *loum* ‘say’ must occur metathesised before the demonstrative *ba* or the aspectual marker *kana* ‘already, PFV’, as shown in (66) and (67) below.

- | | | |
|------|--|--|
| (66) | a. <i>ge-loum ba lewois obo!</i>
3-say\M DEM listen this
‘Listen to his saying!’ | b. * <i>ge-lomu ba lewois obo!</i>
3-say\U DEM listen this
‘(Listen to his saying!)’ |
| (67) | a. <i>neta looro loum kana</i>
1SG right say\M PRF
‘I’ve said it right.’ | b. * <i>neta looro lomu kana</i>
1SG right say\U PRF
‘(I’ve said it right.)’ |

The basis for metathesis in examples such as (64)–(67) is not entirely clear. This may be a case of morphemically conditioned metathesis, though more data is needed on Wersing to determine this.

2.3.4 Bunak

Bunak (Trans-New Guinea, Timor) has morphemically conditioned metathesis (§2.2.2) and morphological metathesis (§2.2.3). In Bunak the initial CV sequence of a CVVC stem metathesises when a prefix is added and the first vowel of the root is high, /i/ or /u/, and the second vowel is non-high, /e/, /a/ or /o/. While

⁷If the distribution of metathesised and unmetathesised forms in Wersing is predictable and in complementary distribution, it would be impossible to determine which of the CV or VC final form of metathesising words is underlying.

2.3 Survey of languages with synchronic metathesis

stress is normally penultimate in Bunak, CV[+HIGH]V[-HIGH]C words have final stress (Antoinette Schapper p.c. September 2015). Such final stress remains after metathesis.

Examples of Bunak metathesis are given in (68) with the prefix *gV-* which marks third person animate possessors on nouns and third person animate objects or undergoers with verbs. Schapper (2009) notes that the eight stems in (68) are the only ones in her corpus which are both eligible to take prefixes and of the appropriate phonological structure to undergo metathesis. Before other consonant-initial stems, the unspecified vowel of the prefix *gV-* is a copy vowel.

Before vowel-initial stems the unspecified vowel of a prefix is deleted: e.g. *gV-* + *'iwal* 'pick' → *'giwal* and *gV-* + *'ube* 'block' → *'gube*. Such vowel deletion also takes place before the metathesising stems.

(68) Bunak metathesis

(Schapper 2009: 67)

<i>gV-</i>	+	<i>'teke?</i>	→	<i>ge-'teke?</i>	'watch'
<i>gV-</i>	+	<i>'iwal</i>	→	<i>'g-iwal</i>	'pick'
<i>gV-</i>	+	<i>lu'el</i>	→	<i>g-ul'el</i>	'skin, peel'
<i>gV-</i>	+	<i>mi'en</i>	→	<i>g-im'en</i>	'immediately'
<i>gV-</i>	+	<i>ni'at</i>	→	<i>g-in'at</i>	'first (one)'
<i>gV-</i>	+	<i>nu'as</i>	→	<i>g-un'as</i>	'stink'
<i>gV-</i>	+	<i>nu'ek</i>	→	<i>g-un'ek</i>	'be smelly'
<i>gV-</i>	+	<i>si'e?</i>	→	<i>g-is'e?</i>	'rip'
<i>gV-</i>	+	<i>tu'ek</i>	→	<i>g-ut'ek</i>	'be heavy'
<i>gV-</i>	+	<i>zi'ek</i>	→	<i>g-iz'ek</i>	'fry'

It does not seem possible to motivate the metathesis in Bunak on the basis of the new phonological context created by the addition of the prefix. Thus, I identify this as a case of morphemically metathesis (§2.2.2).

An alternate analysis of the Bunak data would be to posit that the shape VCVC for these stems is underlying, with metathesis of initial VC → CV when such stems are used in isolation. Schapper (2009) does discuss this possibility.

The 1NCL/2 prefix consists only of an unspecified vowel *V-*. Given the rule whereby the final vowel of a prefix is deleted before vowel-initial (and metathesising stems), this means that metathesis is the only phonological signal of 1NCL/2 agreement for metathesising stems. Thus, metathesis in Bunak can be identified as a morphological device to mark 1NCL/2 agreement. The paradigms of two consonant-initial stems, two vowel-initial stems and two metathesising stems are given in Table 2.3 below to show the different allomorphs of the agreement

2 Synchronic metathesis from a cross-linguistic perspective

prefixes. I follow Schapper (2009) in representing the deleted 1INCL/2 affix as a zero prefix in Table 2.3

Table 2.3: Bunak prefixation (Schapper 2009: 66,340)

	C-initial		V-initial		metathesising	
	'watch'	'fetch'	'pick'	'hang'	'peel'	'rip'
Stem	<i>'teke?</i>	<i>wit</i>	<i>'iwal</i>	<i>'obon</i>	<i>lu'el</i>	<i>si'e?</i>
1EXCL	<i>ne-'teke?</i>	<i>ni-'wit</i>	<i>'n-iwal</i>	<i>'n-obon</i>	<i>n-ul'el</i>	<i>n-is'e?</i>
1INCL/2	<i>e-'teke?</i>	<i>i-'wit</i>	<i>∅-iwal</i>	<i>∅-obon</i>	<i>∅-ul'el</i>	<i>∅-is'e?</i>
3ANIM	<i>ge-'teke?</i>	<i>gi-'wit</i>	<i>'g-iwal</i>	<i>'g-obon</i>	<i>g-ul'el</i>	<i>g-is'e?</i>

With the loss of the vowel of the 1INCL/2 prefix, the morphemically conditioned metathesis in Bunak has developed a morphological function. In this respect its development is similar to that of Germanic umlaut (§2.4.1) in which an original conditioning environment was lost. The Bunak data shows one pathway in which morphological metathesis can develop. Other pathways are discussed in §2.4.2 below.

2.3.5 Luang

Luang (Austronesian, Maluku) has synchronic metathesis which is analysed as being phonologically conditioned by Taber & Taber (2015). Metathesis in Luang is one of several processes which occur to join adjacent morphemes into a single rhythm unit; that is, a phrase with only one stressed syllable. A combination of a word and affix always join into a single rhythm unit, while two conjoined words contrast with two words which form separate rhythm units:

However, there is contrast in Luang between separate words being joined into one rhythm segment and being left apart. Known information and mainline event information, especially at peak points of the story, are said so rapidly that many words join into one rhythm segment. When information is new to the hearer or if it is brought into prominence the words are said more slowly, and therefore do not join into one rhythm segment, but remain separate units. (Taber & Taber 2015: 24)

While Taber & Taber (2015) analyse Luang metathesis as being conditioned by speech speed and/or stress placement, these phonological environments are dis-

2.3 Survey of languages with synchronic metathesis

course driven. Metathesis in Luang is thus functionally comparable to discourse-driven metathesis in Amarasi (Chapter 7), though in Amarasi such metathesis is a direct marker of a discourse structure rather than being conditioned by an intermediate phonological structure.

There is a complex set of phonological rules (one of which is metathesis) which operate to join two morphemes together in Luang. Which process operates depends on the phonological shape of the two morphemes, as well as their respective word classes. In the simplest case, the final vowel of the first word is deleted. Such reduction is often followed by assimilation of certain consonants; see Taber & Taber (2015: 25) for details. Examples are shown in (69) below.

(69) Luang vowel deletion⁸ (Taber & Taber 2015: 25)

<i>ʔama</i>	+	<i>-ni</i>	→	<i>ʔamni</i>	[ʔamni]	‘his father’
<i>naʔana</i>	+	<i>=wa</i>	→	<i>naʔanwa</i>	[naʔanwə]	‘s/he ate’
<i>rwoka</i>	+	<i>pa</i>	→	<i>rwokpa</i>	[rʔwokpə]	‘they meet to’

When the first word ends in a high vowel and the second word begins with #CV where the first vowel is not high, the final high vowel of the first word spreads. After spreading the final vowel of a VCV# final word is deleted, resulting in metathesis similar to the process in Selaru described on page 23 above. When the high back vowel /u/ spreads over a coronal consonant (except /r/) it assimilates and becomes a palatal glide [j]. Examples of Luang high vowel spreading are given in (70) below.⁹

(70) Luang high vowel spreading (Taber & Taber 2015: 24)

<i>ʔammai</i>	+	<i>la</i>	→	<i>ʔammailja</i>	[ʔam'mailʔə]	‘we come to’
<i>rmai</i>	+	<i>pa</i>	→	<i>rmaipja</i>	[rmaipʔə]	‘they come for’
<i>au</i>	+	<i>maka</i>	→	<i>aumwaka</i>	[au'm ^w akə]	‘wood that’
<i>rkeni</i>	+	<i>pa</i>	→	<i>rkenpja</i>	[r'kenpʔə]	‘they put it for’
<i>rmati</i>	+	<i>de</i>	→	<i>rmatdje</i>	[r'matdʔə]	‘when they died’
<i>nhoru</i>	+	<i>wa</i>	→	<i>nhorwua</i>	[nhor ^w uə]	‘already finished’
<i>pwou</i>	+	<i>de</i>	→	<i>pwoudje</i>	[pwou'dʔe]	‘that sail boat’
<i>woru</i>	+	<i>la</i>	→	<i>worlja</i>	[worlʔə]	‘two in’

When a CCV# final noun is joined into a single rhythm segment with a morpheme which is consonant initial, the final vowel of the noun is deleted followed

⁸An alternate analysis of the data in (69) would be to posit epenthesis of /a/ after phrase-final consonants. This is the analysis taken by Steven (1991) for similar data in Roma (§2.3.7)

⁹I follow Taber & Taber (2015) in representing glides which are a realisation of vowels after high vowel spreading as superscript in the phonetic transcription.

2 Synchronic metathesis from a cross-linguistic perspective

by epenthesis of the vowel /a/ to break up the newly created consonant cluster. Examples are shown in (71) below.

(71) Luang vowel deletion and epenthesis (Taber & Taber 2015: 26)

<i>likti</i>	+	<i>-ni</i>	→	<i>likatni</i>	[<i>ˈlikatni</i>]	‘his house’
<i>ʔonni</i>	+	<i>=wa</i>	→	<i>ʔonanwa</i>	[<i>ˈʔonanwa</i>]	‘the end’
<i>nniaʔerti</i>	+	<i>-ni</i>	→	<i>nniaʔeratni</i>	[<i>ˈnniaʔeratni</i>]	‘its meaning’
<i>ʔulti</i>	+	<i>pa</i>	→	<i>ʔulatpa</i>		‘skin for’

However, when the first word ends in CCV# and is a verb, metathesis of the final CV sequence occurs. Taber & Taber (2015) state that it is unclear why verbs have a different behaviour from nouns. It is, however, regionally common for nouns and verbs to have different behaviour regarding metathesis. This is found in Mambae (§2.3.8) as well as Amarasí. Examples of Luang verbal metathesis are shown in (72) below.

(72) Luang metathesis (verbs only) (Taber & Taber 2015: 26)

<i>ʔernu</i>	+	<i>la</i>	→	<i>ʔerunla</i>	[<i>ˈʔerunlə</i>]	‘go down to’
<i>towru</i>	+	<i>dojni</i>	→	<i>towurdojni</i>	[<i>ˈtowurˈdojni</i>]	‘spill completely’
<i>hopla</i>	+	<i>=wa</i>	→	<i>hopalwa</i>	[<i>ˈhopalwə</i>]	‘sailed’
<i>hopna</i>	+	<i>pa</i>	→	<i>hopanpa</i>	[<i>ˈhopanpə</i>]	‘order for’
<i>kulti</i>	+	<i>pa</i>	→	<i>kulitpa</i>		‘stick together for’

To summarise: in Luang metathesis is one of several processes which operate when two morphemes (including words) form a single phrase for the purposes of stress assignment. It is therefore possible to analyse metathesis as being conditioned by the placement of stress.¹⁰

There is also no apparent phonological reason why metathesis affects verbs but not nouns in Luang. While Luang metathesis is phonologically conditioned, it is not clearly phonologically motivated. Metathesis in Luang may be transitioning from phonologically conditioned metathesis to morphemically conditioned or morphological metathesis. Indeed, Leti which is culturally considered a Luangic dialect has developed morphological metathesis (§2.3.6).

¹⁰An alternate analysis would be to propose that words are joined into a single word/phrase by the various phonological processes (including metathesis), and then stress is assigned as appropriate.

2.3.6 Leti

Leti is an Austronesian language of Indonesia spoken on an island with the same name off the eastern-most tip of the island of Timor (see Figure 2.1). It is closely related to Luang (§2.2.1), which has phonologically conditioned metathesis. Leti metathesis has been described by van Engelenhoven (1994; 1996; 2004) and formal analyses of it have been proposed by van der Hulst & van Engelenhoven (1995), as well as Hume (1998).

2.3.6.1 Forms

In Leti each word has a least two forms; a vowel-final U-form and an M-form which is often consonant final. A single Leti U-form does not necessarily correspond to a single M-form. Rather, the phonological shape of both the form in question and the following morpheme must be taken into account when determining the shape of the M-form. For instance, the Leti U-form *iina* ‘fish’ can have either of the M-forms *iin* or *ian*, depending on the phonological shape of the following morpheme. In this respect, Leti is similar to Amarasi in which a single U-form can have up to three different M-forms in different environments (see Chapter 4).

Four different phonological processes operate in Leti to derive each different form: glide formation, internal metathesis, external metathesis, and apocope. Each of these processes is described with reference to the phonological shape of the U-form of the first word. There are four possible shapes for Leti U-forms:

- i. VV# final e.g. *nia* ‘snake’
- ii. VCV# final e.g. *kusa* ‘cat’
- iii. V_αV_αCV# final e.g. *iina* ‘fish’
- iv. VCCV# final e.g. *emna* ‘moray eel’

2.3.6.1.1 No change When the second word begins with a consonant cluster, the first word does not undergo any phonological processes and appears in the vowel-final U-form.

(73) No phonological process (van Engelenhoven 2004: 91)

U-form		M-form	
<i>lau</i>	+ <i>tniei</i>	→ <i>lau tniei</i>	‘civet + guts’
<i>ruuni</i>	+ <i>tniei</i>	→ <i>ruuni tniei</i>	‘dugong + guts’

2 Synchronic metathesis from a cross-linguistic perspective

2.3.6.1.2 Glide formation When the first word ends with a high vowel and the second word begins with a non-high vowel /e/, /ɛ/, /a/, /ɔ/ or /o/, the final vowel of the first word is realised as a glide. Examples are given in (74).

This is an automatic phonetic process, as glides do not contrast phonemically with high vowels in Leti. A high vowel is automatically realised as a glide when it occurs before a stressed non-high vowel (van Engelenhoven 2004: 59).

(74) CV[+HIGH] → CṾ[+HIGH] / _V[-HIGH] (van Engelenhoven 2004: 91)

U-form		M-form		
<i>lau</i>	+	<i>aana</i>	→	<i>lau aana</i> [law'a:na] 'civet + child'
<i>ruuni</i>	+	<i>aana</i>	→	<i>ruuni aana</i> [ru:nj'a:na] 'dugong + child'

2.3.6.1.3 Internal metathesis If the second word begins with a CV sequence, or a sequence of a high vowel followed by a vowel (phonetically a glide followed by a vowel; as discussed in §2.3.6.1.2 above), and the U-form of the first word ends in CCV#, then the M-form of the first word corresponds to the U-form via metathesis of the final CV sequence.

(75) C₁VC₂ → C₁C₂V / _CV (van Engelenhoven 2004: 91)

U-form		M-form		
<i>ɛmna</i>	+	<i>nama</i>	←	<i>ɛman nama</i> 'moray + tongue'
<i>plilki</i>	+	<i>ruri</i>	←	<i>plilik ruri</i> 'k.o. lizard + bone'
<i>trutnu</i>	+	<i>ɣata</i>	←	<i>trutun ɣata</i> 'Blurr-fish + head'

There is a process of consonant assimilation which operates in Leti which provides evidence that the underlying form of CCV final U-forms is the M-form. A penultimate /d/ or /l/ in the M-form assimilates to a final /n/ in the U-form. Likewise, a penultimate /d/ in the M-form assimilates to a U-form final /l/. Examples are given in (76) below.

(76) Consonant assimilation (van Engelenhoven 2004: 74)

M-form		U-form		
<i>βenan</i>	→	<i>βenna</i>		'kill'
<i>ɛdan</i>	→	<i>ɛnna</i>		'pineapple'
<i>βulan</i>	→	<i>βulla</i>		'moon'
<i>sudal</i>	→	<i>sulla</i>		'prop'

Given a U-form such as *ɛnna* 'pineapple', it is impossible to predict whether the M-form will be **enan* or *ɛdan*. Likewise, given the U-form *βulla* either the

correct M-form *bulan* or the incorrect form **budal* can be derived. This provides evidence that the M-form in such examples is morphologically underlying with the U-form being formed by final VC → CV metathesis.

Another kind of internal metathesis occurs when the antepenultimate and penultimate vowels of the first word are identical; a $V_\alpha V_\alpha CV_\beta$ final word. In the M-form the final consonant and vowel metathesise and the penultimate vowel is deleted. Like the process of VC → CV metathesis shown in (75) above, this only occurs when the second word begins with CV. Examples are given in (77) below.

(77) $V_\alpha V_\alpha CV_\beta \rightarrow V_\alpha V_\beta C/_CV$ (van Engelenhoven 2004: 91)

U-form		M-form	
<i>iina</i>	+ <i>nama</i>	→ <i>ian nama</i>	'fish + tongue'
<i>ruuni</i>	+ <i>ruri</i>	→ <i>ruin ruri</i>	'dugong + bone'
<i>maanu</i>	+ <i>uata</i>	→ <i>maun uata</i>	'bird + head'

2.3.6.1.4 External metathesis When the first word ends in a vowel sequence or VCV# and the second word begins with #CV with a non-high initial vowel, metathesis occurs across the word boundary. According to the regular phonetic rule of glide formation, the final V of the first word becomes a glide. This process is similar to phonological metathesis of glides in Selaru (§2.2.1).

(78) $V_1[+HIGH]\#CV_2[-HIGH] \rightarrow CV_1V_2$ (van Engelenhoven 2004: 91)

U-form		M-form	
<i>srui</i>	+ <i>nama</i>	→ <i>sruniama</i>	[srunj'ama] 'garfish + tongue'
<i>lau</i>	+ <i>nama</i>	→ <i>lanuama</i>	[lanw'ama] 'civet + tongue'
<i>niki</i>	+ <i>nama</i>	→ <i>nikniama</i>	[niknj'ama] 'bat + tongue'
<i>asu</i>	+ <i>nama</i>	→ <i>asnuama</i>	[asnw'ama] 'dog + tongue'

2.3.6.1.5 Apocope Apocope (a.k.a truncation or vowel deletion) occurs in three environments in Leti. Firstly, apocope occurs when the first segment of the second word is a high vowel (but not a glide), no matter the shape of the first word. Examples are shown in (79) below:

2 Synchronic metathesis from a cross-linguistic perspective

(79) $V \rightarrow \emptyset / _V[+\text{HI}]$ (van Engelenhoven 2004: 91)

U-form		M-form	
<i>sru</i>	+ <i>irnu</i> →	<i>sru irnu</i>	‘garfish + nose’
<i>lau</i>	+ <i>irnu</i> →	<i>la irnu</i>	‘civet + nose’
<i>niki</i>	+ <i>irnu</i> →	<i>nik irnu</i>	‘bat + nose’
<i>asu</i>	+ <i>irnu</i> →	<i>as irnu</i>	‘dog + nose’
<i>ruuni</i>	+ <i>irnu</i> →	<i>ruun irnu</i>	‘dugong + nose’
<i>maan</i>	+ <i>irnu</i> →	<i>maan irnu</i>	‘bird + nose’
<i>plilki</i>	+ <i>irnu</i> →	<i>plilk irnu</i>	‘k.o. lizard + nose’
<i>trutnu</i>	+ <i>irnu</i> →	<i>trutn irnu</i>	‘Blurr-fish + nose’

Secondly apocope takes place when the first word ends in VCV# or VV# (but not VVCV), and the second word begins with a high vowel, as seen in (79) above, or a consonant (including glides) followed by a high vowel, as shown in (80).

(80) $V \rightarrow \emptyset / _(\text{C})V[+\text{HI}], / _ \text{VV}$ (van Engelenhoven 2004: 91)

U-form		M-form	
<i>sru</i>	+ <i>ruri</i> →	<i>sru ruri</i>	‘garfish + bone’
<i>lau</i>	+ <i>ɥata</i> →	<i>la ɥata</i>	‘civet + head’
<i>niki</i>	+ <i>ɥata</i> →	<i>nik ɥata</i>	‘bat + head’
<i>asu</i>	+ <i>ruri</i> →	<i>as ruri</i>	‘dog + bone’

Thirdly, apocope takes place when the first word ends in VV or VCV with a non-high final vowel and the first vowel of the second word is also a non-high vowel. This is shown in (81) below.

(81) Apocope: $V[-\text{HIGH}] \rightarrow \emptyset / _(\text{C})V[-\text{HIGH}]$ (van Engelenhoven 2004: 91)

U-form		M-form	
<i>nia</i>	+ <i>aana</i> →	<i>ni aana</i>	‘snake + baby’
<i>kusa</i>	+ <i>aana</i> →	<i>kus aana</i>	‘cat + baby’
<i>ɛmna</i>	+ <i>aana</i> →	<i>ɛmn aana</i>	‘moray + baby’
<i>nia</i>	+ <i>nama</i> →	<i>ni nama</i>	‘snake + tongue’
<i>kusa</i>	+ <i>nama</i> →	<i>kus nama</i>	‘cat + tongue’

2.3.6.1.6 Summary The different processes which operate in Leti to derive the M-form from the U-form are summarised in Table 2.4. This table is followed by Table 2.5 which shows instantiated examples of each of these processes. Metathesis in Leti is only one of several phonological processes which operate in the language to derive M-forms.

2.3 Survey of languages with synchronic metathesis

Which form is the underlying form is not consistent in Leti. In some cases the U-form must be posited as underlying as the quality of the final vowel cannot be recovered after apocope, while in other cases the M-form must be posited as underlying as the quality of the penultimate consonant cannot be recovered after metathesis. This is different to the Amarasi data, in which the U-form must be posited as underlying in all circumstances.

Table 2.4: Leti U-forms and M-forms

U-form↓ before:	CCV	CV _{+h}	C ₂ V _{-h}	V _{+h}	V _{-h}
V(C)V	V(C)V	V(C)	V(C)	V(C)	V(C)
V(C)V[+HIGH]	V(C)V	V(C)	V(C)C ₂ V	V(C)	V(C)V
V{ $\frac{C}{V}$ }CV	V{ $\frac{C}{V}$ }CV	V{ $\frac{C}{V}$ }VC	V{ $\frac{C}{V}$ }VC	V{ $\frac{C}{V}$ }C	V{ $\frac{C}{V}$ }C
V{ $\frac{C}{V}$ }CV[+HIGH]	V{ $\frac{C}{V}$ }CV	V{ $\frac{C}{V}$ }VC	V{ $\frac{C}{V}$ }VC	V{ $\frac{C}{V}$ }C	V{ $\frac{C}{V}$ }CV

□ apocope, ■ metathesis, ■ ext. metathesis, ■ glide formation

Table 2.5: Leti instantiated U-forms and M-forms

U-form↓ before:	CCV	CV _{+h}	C ₂ V _{-h}	V _{+h}	V _{-h}	
VV <i>nia</i>	<i>nia</i>	<i>ni</i>	<i>ni</i>	<i>ni</i>	<i>ni</i>	‘snake’
VV _{+H} <i>lau</i>	<i>lau</i>	<i>la</i>	<i>la</i> C ₂ u	<i>la</i>	<i>lau</i>	‘civet’
VCV <i>kusa</i>	<i>kusa</i>	<i>kus</i>	<i>kus</i>	<i>kus</i>	<i>kus</i>	‘cat’
VCV _{+H} <i>asu</i>	<i>asu</i>	<i>as</i>	<i>as</i> C ₂ u	<i>as</i>	<i>asu</i>	‘dog’
VVCV <i>iina</i>	<i>iina</i>	<i>ian</i>	<i>ian</i>	<i>iin</i>	<i>iin</i>	‘fish’
VVCV _{+H} <i>maanu</i>	<i>maanu</i>	<i>maun</i>	<i>maun</i>	<i>maan</i>	<i>maanu</i>	‘bird’
VCCV <i>emna</i>	<i>emna</i>	<i>eman</i>	<i>eman</i>	<i>emn</i>	<i>emn</i>	‘eel’
VCCV _{+H} <i>plilki</i>	<i>plilki</i>	<i>plilik</i>	<i>plilik</i>	<i>plilk</i>	<i>plilkj</i>	‘lizard’

□ apocope, ■ metathesis, ■ ext. metathesis, ■ glide formation

2.3.6.2 Functions

The M-form of words occur in Leti in two main environments: when the word is non-final in the noun phrase and when it is indefinite. Note that the enclitic =e in many of the following examples replaces a final /a/ of the word to which

it attaches. This enclitic is a kind of definiteness marker (for a more detailed discussion of this enclitic see van Engelenhoven (2004: 159–61)). Words which do not end in /a/ do not occur with this enclitic.

2.3.6.2.1 Attributive modification All non-final words in the noun phrase occur in the M-form. This function also occurs in Rotuman (§2.3.2.2.1) and Amarasi (Chapter 6). In (82) below, the noun *asu* is in the U-form and the adjective is predicative, as shown in the tree in (84). In (83) below, the noun is in the M-form, and the adjective is attributive, as shown in the tree in (85).

(82) *asu lalaβne*
asu la~laβna=e
dog\U RED~big=DEF
 ‘The dog is big.’

(83) *aslualaβne*
asu la~laβna=e
dog\M RED~big=DEF
 ‘The big dog.’

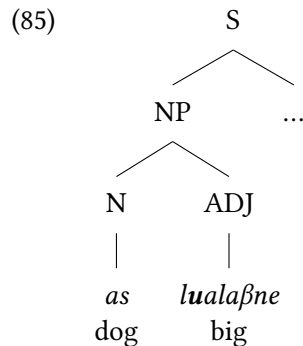
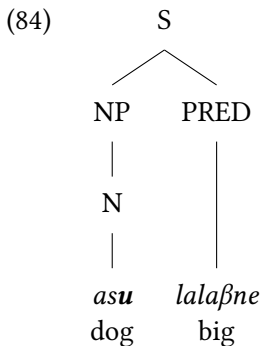

Any non-final word of the noun phrase, including adjectives and adverbs, also occur in the M-form. This is shown in example (86) below in which a noun, adjective, and adverb all occur in the M-form when the final word of the noun phrase is a demonstrative.

(86) *kus memetam daβar dí*
kusa me~metma daβra dí
cat\M RED~black\M very\M DEM1
 ‘This very black cat.’

(van Engelenhoven 2004: 177)

However, nouns followed by a numeral do not occur in the M-form, as shown in (87). This is similar to Amarasi in which (cardinal) numerals do not induce M-forms on nouns (§6.5.1).

2 Synchronic metathesis from a cross-linguistic perspective

Metathesis, as one of the processes by which the M-form is derived, has two functions in Leti: it marks following nominal modifiers as attributive and it is employed to mark words as indefinite. Of these functions, the first also occurs in Amarasi.

2.3.7 Roma

Roma, or Romang, is an Austronesian language spoken on an island of the same name to the north-east of Timor (see Figure 2.1). It is closely related to both Leti and Luang. Roma has been described by Steven (1991), who focusses on the phonology of the language.

2.3.7.1 Forms

Roma has three different processes of metathesis. Two of these metathesis processes are phonologically conditioned and one is morphological. Firstly, Roma has a process of phonologically conditioned metathesis in which a high vowel or glide metathesises with a following consonant. This process is similar to the processes in Selaru (§2.2.1) and Luang (§2.2.1). Examples are given in (92) below.

(92) Phonological glide metathesis: (Steven 1991: 63f)

<i>aw-</i>	+	<i>karar</i>	→	<i>akwarar</i>	[ʔa ^w k ^w aʔar]	‘I cry’
<i>mw-</i>	+	<i>karar</i>	→	<i>mkwarar</i>	[m ^w k ^w arar]	‘you (sg.) cry’
<i>mj-</i>	+	<i>karar</i>	→	<i>mkjarar</i>	[m ^j k ^j arar]	‘you (pl.) cry’
<i>n-mai</i>	+	<i>me</i>	→	<i>namamje</i>	[n ^m mamje]	‘he came in order to’
<i>aniku</i>	+	<i>kaka</i>	→	<i>anikkwaka</i>	[ʔanik ^w k ^w aka]	‘my older brother’

Secondly, /h/ obligatorily metathesises with a preceding consonant in Roma. One example is *am-* ‘PL.EXCL + *hapa* ‘plant’ → *ahmapa* ‘we (excl.) plant’ (Steven 1991: 69).

Thirdly, Roma has a process of final VC → CV morphological metathesis. This process is similar to the same process described for Leti. This process only affects consonant-final nouns in Roma. Examples are given in (93) below.

(93) VC → CV metathesis Steven (1991: 64ff)

U-form	M-form	gloss	U-form	M-form	gloss					
<i>hiwit</i>	→	<i>hiwti</i>	<i>snjinin</i>	→	<i>snjinni</i>	‘machete’	<i>snjinin</i>	→	<i>snjinni</i>	‘song’
<i>ulit</i>	→	<i>ulti</i>	<i>jair</i>	→	<i>jari</i>	‘skin’	<i>jair</i>	→	<i>jari</i>	‘wave’
<i>ihan</i>	→	<i>ihna</i>	<i>oir</i>	→	<i>ori</i>	‘fish’	<i>oir</i>	→	<i>ori</i>	‘water’
<i>hurat</i>	→	<i>hurta</i>	<i>hljaut</i>	→	<i>hljatu</i>	‘letter’	<i>hljaut</i>	→	<i>hljatu</i>	‘story’

2.3 Survey of languages with synchronic metathesis

Evidence that the consonant-final forms are underlying comes from processes of consonant assimilation which occur after metathesis. These processes include devoicing of medial /d/ and assimilation of final /l/ and /r/. (These processes of consonant assimilation are similar to those described for Leti on page page 52.) Examples of Roma consonant assimilation are given in (94) below.

(94) Consonant assimilation Steven (1991: 31,65)

U-form		M-form	gloss
<i>madar</i>	→	<i>matta</i>	‘cuscus’
<i>odan</i>	→	<i>otna</i>	‘drying rack’
<i>wulan</i>	→	<i>wulla</i>	‘moon’
<i>melan</i>	→	<i>mella</i>	‘mouse’
<i>tjalan</i>	→	<i>tjalla</i>	‘road’

2.3.7.2 Functions

Only nouns undergo metathesis in Roma. Verbs occur with a single consonant-final form. For nouns, metathesis has two main functions. Firstly, subjects undergo metathesis while objects occur unmetathesised. Metathesis is thus a subject marker or marker of nominative case. Compare examples (95) and (96) below.

(95) *n-la n-dahal hiwit-a.*
 3SG-go 3SG-search machete\U-EPENTH
 ‘He searched for a machete’

(96) *hiwti ta-walli.*
 machete\M NEG-exist
 ‘There wasn’t any machetes.’ (Steven 1991: 67)

In (95) the noun *hiwit* is an object and thus occurs unmetathesised. The final vowel found after this object is an epenthetic vowel which occurs after all phrase-final consonants (Steven 1991: 69f). In (96) the same noun is the subject and thus occurs metathesised.

Secondly, nouns occur metathesised in isolation (including the citation form) but unmetathesised when an attributive modifier follows. Metathesis thus signals that the noun is unmodified; a kind of anti-construct form. Steven (1991) gives the examples in (97) below.

2 Synchronic metathesis from a cross-linguistic perspective

(97) Unmetathesised forms in the noun phrase: (Steven 1991: 67)

<i>horarna</i>					‘clothes’ (citation)
<i>horaran</i>	+	<i>ehi</i>	→	<i>horaran ehi</i>	‘these clothes’
<i>krahna</i>					‘house’ (citation)
<i>krahan</i>	+	<i>popotna</i>	→	<i>krahan popotna</i>	‘large house’

However, if a genitive pronoun or the locative marker *la* precedes the noun it obligatorily occurs in the unmetathesised form even if a modifier follows. Steven (1991) gives the examples in (98) below.

(98) Metathesis after locative or possessive pronouns: (Steven 1991: 67)

<i>aniku</i>	+	<i>horaran</i>	+	<i>ehi</i>	→	<i>aniku horarna ehi</i>	‘these clothes of mine’
<i>la</i>	+	<i>krahan</i>	+	<i>popotna</i>	→	<i>la krahna popotna</i>	‘at the large house’

Similarly, before the enclitics =*ei* DEF and =*ida* INDEF nouns obligatorily occur metathesised. Final high vowels then become glides and final /a/ is deleted. Glide formation and deletion of /a/ are both regular process in Roma which occur whenever a vowel-initial enclitic or suffix attaches to a host which ends in a vowel (Steven 1991: 78f). Examples are given in (99) below.

(99) Metathesis before vowel-initial enclitics: (Steven 1991: 67)

<i>hiwit</i>	+	= <i>ei</i>	→	<i>hiwtiei</i>	→	<i>hiwtjei</i>	‘the machete’
<i>horaran</i>	+	= <i>ei</i>	→	<i>horarnaei</i>	→	<i>horarnei</i>	‘the clothes’
<i>hljaut</i>	+	= <i>ida</i>	→	<i>hljatuida</i>	→	<i>hljatwida</i>	‘a story’

In Roma metathesis marks the subject of a verb phrase as well as signalling that a noun is unmodified. Metathesis is also obligatory when a noun occurs after possessive pronouns, locative *la* or before vowel-initial enclitics.

There are two similarities between metathesis in Roma and Amarasi. Firstly, metathesis interacts with attributive modifiers. In Roma metathesis signals lack of an attributive modifier while in Amarasi metathesis signals the presence of an attributive modifier. Secondly, in both Roma and Amarasi metathesis is obligatory before vowel-initial enclitics.

2.3.8 Mambae

Mambae is an Austronesian language/dialect cluster spoken in Timor-Leste (East Timor), from the north coast around Dili all the way to the south coast (see Figure

2.3 Survey of languages with synchronic metathesis

2.1). On the basis of lexical comparison, Fogaça (2017) identifies three main varieties of Mambae: Northwest Mambae, Central Mambae, and South Mambae. The forms and functions of metathesis vary between different varieties of Mambae.

In this section I focus on South Mambae from the village (*suco*) of Letefoho; the variety which is the focus of the descriptions in Grimes et al. (2014) and Fogaça (2017). I offer some initial observations on metathesis in other varieties in §2.3.8.3 based on the comparative data in Fogaça (2017).

2.3.8.1 Forms

Metathesis in South Mambae is final CV → VC metathesis. Only words ending in CV have distinct U-forms and M-forms. Examples of metathesis in South Mambae are given in (100) below.

(100) South Mambae metathesis (Fogaça 2017: 122)

U-form		M-form	
<i>etu</i>	→	<i>eut</i>	‘rice’
<i>mane</i>	→	<i>maen</i>	‘male, man’
<i>dato</i>	→	<i>daot</i>	‘nobleman’
<i>brusi</i>	→	<i>bruis</i>	‘hot’
<i>kode</i>	→	<i>koed</i>	‘good’
<i>fata</i>	→	<i>faat</i>	‘four’
<i>futu</i>	→	<i>fuut</i>	‘together’

Metathesis is associated with two other phonological processes. The first is assimilation of final /a/ to the quality of the previous vowel after metathesis. This is shown in (101) below, which also gives reconstructed Proto-Malayo-Polynesian (PMP) forms for comparison. U-forms which are not (yet) attested are indicated with an asterisk. Such assimilation also occurs in Amarasí.

(101) South Mambae $V_{\alpha}Ca \rightarrow V_{\alpha}V_{\alpha}C$ (Fogaça 2017: 122)

PMP	U-form		M-form	
*ina	<i>ina</i>	→	<i>iin</i>	‘mother’
*binai	<i>hina</i>	→	<i>hiin</i>	‘woman’
*Rumaq	<i>uma</i>	→	<i>uum</i>	‘house’
*quzan	* <i>usa</i>	→	<i>uus</i>	‘rain’

Assimilation of final /a/ only occurs after metathesis and /a/ freely occurs as the second member of a vowel sequence in VVC# final words. Two examples are *kiak* ‘poor’ and *hean* ‘rowing’.

2 Synchronic metathesis from a cross-linguistic perspective

Secondly, word-final /i/ usually lowers to /e/ after metathesis when the penultimate vowel is /a/. Examples are given in (102) below. Where the U-form is not (yet) known to occur, this is indicated with an asterisk.

(102) South Mambae aCi → aeC

PMP	U-form		M-form	
*talih	<i>tali</i>	→	<i>tael</i>	‘rope’
*kami	<i>ami</i>	→	<i>aem</i> ~ <i>aim</i>	‘we (excl.)’
*babuy	*hahi	→	<i>haeh</i>	‘pig’
*hapuy	*afi	→	<i>aef</i>	‘fire’
*tasik	*tasi	→	<i>taes</i>	‘sea’

Again, lowering of /i/ → /e/ in South Mambae is restricted to M-forms. The vowel /i/ freely occurs as the second member of a vowel sequence in VVC# final roots, such as *arai*k ‘lower, humble’, *tai*s ‘no, not’ and *sabai* ~ *sabait* ‘cloud’.¹¹

The processes of vowel assimilation which occur after metathesis in Mambae show that the M-form is derived from the U-form and not visa versa. While in all cases the M-form can be predicted with knowledge of the U-form, the reverse is not true. Thus, given an M-form such as *hiin* ‘woman’ we can generate both the correct U-form *hina* and incorrect **hini*. Similarly, given the M-form *tael* ‘rope’ both correct *tali* and incorrect **tale* are possible U-forms

2.3.8.2 Functions

Metathesis has three main functions in South Mambae: derivation, phrase formation, and possession. Each of these functions is discussed in turn. All these functions are examples of morphological metathesis (§2.2.3).

Formally, the M-form is derived from the U-form. However, the M-form appears to be the default semantic form with the U-form having specific functions. Thus, for instance, most words are cited in the M-form and many words have only been attested in the M-form.

2.3.8.2.1 Derivation Metathesis is also used in derivation in Mambae. One productive derivational use is noun/verb derivation. Examples are given in (103) below. If the M-form is the basic semantic form as suggested above, this would be a process of nominalisation.

¹¹The sequence /ai/ is often realised [əi] with the first vowel centralised (Grimes et al. 2014: 6).

(103) South Mambae derivation Fogaça (2017: 136)

	M-form	U-form	
'die, be dead'	<i>maet</i>	<i>mate</i>	'death'
'love' (v.)	<i>doim</i>	<i>domi</i>	'love' (n.)
'live'	<i>moir</i>	<i>mori</i>	'life'
'teach'	<i>noir</i>	<i>nori</i>	'teaching, lesson'
'take care'	<i>kuidaud</i>	<i>kuidadu</i>	'care, caution'
'approach'	<i>fedeis</i>	<i>fedesi</i>	'near, close'
'break'	<i>aof</i>	<i>afo</i>	'broken'

That the loanword *kuidadu* 'care, caution' (from Portuguese *cuidado*) also has a verbal and nominal form derived by metathesis is evidence that this is a productive process in South Mambae.

In addition to such verb/noun pairs, there are a number of U-form/M-form pairs which are semantically and/or historically related but for which the M-form is not a verb. Examples include *lima* 'hand, arm', *liim* 'five', *tona* 'year, age, birthday', *toon* 'year', and *muna* 'long ago, previously', *muun* 'before'.

Examples of uses of the U-form and M-form of *mate* ~ *maet* 'die, be dead; death' are given in (104) below, an excerpt from a narrative about the war for independence in Timor-Leste. The U-forms appear to be used in a more active (process) sense while the M-forms are used in a more stative (result) sense. This text was collected during a 2012 language documentation workshop (see §1.4).

(104) South Mambae narrative:

- a. *mas ni momentu kidura*
but LOC time DISTAL
'But at that time,'
- b. *artuub rini fe mate*
person many REL die\U
'many people died.'
- c. *man tilu ni ai lala met mate*
like currently LOC tree inside also die\U
'(It was the) same in the jungle (they) also died.'
- d. *maa rende telo met mate*
come surrender finish also die\U
'(They) came and surrendered and also died.'

2 Synchronic metathesis from a cross-linguistic perspective

- e. *i artuub rini fe mate*
 then person many REL die\U
 ‘And many people died.’
- f. *ni uum seer maet, ni familia seer maet met*
 LOC house\M several die\M LOC family several die\M also
 ‘Several were dead in a house, several were also dead in a family.’
- g. *ubu kiid fe mori*
 CLASSIFIER one REL live
 ‘(Maybe only) one person lived.’
- h. *maet ba loos deslaa kilat hua*
 die\M NEG truly because weapon fruit
 ‘Dead not because of rifle bullets.’
- i. *mas maet deslaa moras, i namaa ba nei*
 but die\M because sick and food NEG EXIST
 ‘but dead because of sickness and lack of food.’

2.3.8.2.2 **Phrase formation** Metathesis in South Mambae plays a role in compounding and other phrase formation processes. The first element of a phrase tends to occur in the M-form and the final element in the U-form. Examples of unmetathesised words phrase finally are given in (105) below. All these words are metathesised in the citation form.

(105) South Mambae phrase formation Grimes et al. (2014)

citation	phrase	gloss	trans
<i>hiin</i>	<i>aan hina</i>	child female	‘girl, daughter’
<i>hiin</i>	<i>taes hina</i>	sea female	‘north coast’
<i>maen</i>	<i>taes mane</i>	sea male	‘south coast’
<i>haut</i>	<i>ulu hatu</i>	head stone	‘head, skull’
<i>iid</i>	<i>liim nai nida</i>	five and one	‘six’
<i>teul</i>	<i>liim nai telu</i>	five and three	‘eight’
<i>faat</i>	<i>liim nai fata</i>	five and four	‘nine’

It is not a strict rule that phrase-final elements are always in the U-form. Thus, in addition to *taes hina* ‘north coast’ and *taes mane* ‘south coast’, we also find *taat hiin* ‘grandmother’ and *taat maen* ‘grandfather’. The degree of lexicalisation may play a role, with lexicalised phrases occurring with M-form initial elements and U-form final elements.

2.3.8.2.3 **Direct possession** Metathesis also plays a role in possessive constructions. South Mambae has two different possessive constructions: indirect possession and direct possession. Indirect possession is expressed with the possessive particle *ni*. The order is either possessor-*ni*-possessum, as in (106), or possessum-possessor-*ni*, as in (107).

(106) *au fliik Euriko ni tero ni uri.*
 1SG hear Euriko POSS voice LOC here
 ‘I heard Euriko’s voice here’

(107) ... *tradisaun een la Same ni*
 tradition about to Same POSS
 ‘about the traditions of Same’ (Fogaça 2017: 145)

Direct possession is expressed by the possessor occurring before a U-form possessum. Compare the examples in (108)–(111) below. In (108) the noun *mane* ‘male, man, husband’ is not possessed and occurs in the M-form while in (109) the same noun is possessed and thus occurs in the U-form. Similarly, in (110) *uma* ‘house’ occurs unpossessed and in the M-form while in (111) it occurs possessed and in the U-form.

(108) *maen idura la universidadi.*
 man\M PROXIMAL to university
 ‘This man goes to university.’

(109) *ura mane la universidadi.*
 3SG man\U to university
 ‘Her husband goes to university.’

(110) *au laa uum*
 1SG go house\M
 ‘I’m going to a house.’

(111) *au laa au uma*
 1SG go 1SG house\U
 ‘I’m going to my house.’ (Fogaça 2017: 146f)

Use of the U-form for the possessum in direct possessive constructions is similar to the use of U-forms in phrase formation. In both constructions the U-form is used as the second element of the phrase.

One possible reason for this similarity is that the phrases with final U-forms are (or were) originally possessive constructions. This approach is hinted at by

2 Synchronic metathesis from a cross-linguistic perspective

Fogaça (2017: 147) who identifies one function of direct possession as expressing a part-whole relation, as in *haeh sisa* ‘pig meat’ = ‘pork’ and *ai tia* ‘tree skin’ = ‘bark’.

Fogaça (2017: 146) reports that direct possession in Northwest Mambae and Central Mambae is expressed with the suffix *-n* on the possessum, examples of which occur in the citation form of several body parts and kin terms in Fogaça’s appended wordlists. Examples from Northwest Mambae (Railaco sub-district) include *gugu-n* ‘mouth’, *lima-n* ‘arm’, and *ina-n* ‘mother’.

Given that CVC# final words do not have M-forms in Mambae, the use of U-forms in direct possession in South Mambae appears to have arisen from the possessum originally taking the suffix *-n*, thus being consonant final and ineligible to undergo metathesis. After loss of the suffix the only signal of possession was the U-form.

2.3.8.3 Other varieties of Mambae

Fogaça (2017) also presents some survey data from other varieties of Mambae on the basis of which it is possible to make some preliminary observations on differences in metathesis among varieties of Mambae.

The citation forms of a number of common nouns from seven different varieties of Mambae are given in Table 2.6 for comparison. These forms are taken from the comparative wordlists in Fogaça (2017), with phonetically long vowels retranscribed as double according to their phonemic structure and the putative nominal suffix *-a* separated by a hyphen.¹²

Table 2.6 shows that a suffix *-a* frequently occurs on common nouns in Central Mambae and Northwest Mambae. This suffix is not synchronically attested in South Mambae. Before this suffix CV# final words obligatorily undergo metathesis (Fogaça 2017: 126).¹³ A similar pattern occurs in Amarasi in which metathesis is obligatory before vowel-initial enclitics (Chapter 5).¹⁴

The data in Table 2.6 also show a number of differences in the forms of metathesis between different varieties of Mambae. The main differences are in the kinds of vowel assimilation which occur. This ranges from no assimilation (apart from final /a/) in Laulara to complete assimilation of nearly all vowels in Hatu-Udo, as

¹² Although the difference between the mid-high vowels [e] [o] and mid-low [ɛ] [ɔ] is known not to be phonemic in South Mambae, I have maintained Fogaça’s distinction between these vowels in Table 2.6 as their status in other varieties is not known.

¹³ When the suffix *-a* occurs on VV# final words, no change occurs. An example is *ai-a* ‘tree’.

¹⁴ One vowel-initial enclitic in Amarasi is the nominal determiner *=aa*, which may well be cognate with the Mambae nominal suffix *-a*.

2.3 Survey of languages with synchronic metathesis

Table 2.6: Common Nouns in Different Mambae Varieties[†]

PMP	*talih	*wani	*hapuy	*babuy	*bituqən	*batu		
P. Mam.	*tali	*ani	*api	*hahi	*hitu	*hatu	*gelu	*neru
Letefoho	<i>tael</i>	<i>aen</i>	<i>aɛf</i>	<i>hæh</i>	<i>hiut</i>	<i>haut</i>	<i>keul</i>	<i>neor</i>
Betano	<i>tael</i>	<i>aen</i>	<i>aɛp</i>	<i>hæh</i>	<i>hiit</i>	<i>haat</i>	<i>geel</i>	<i>neer</i>
Hatu-U.	<i>taal</i>	<i>aan</i>	<i>aap</i>	<i>hae</i>	<i>hiit</i>	<i>haat</i>	<i>kɛɛl</i>	<i>neer</i>
Laulara	<i>tail-a</i>	<i>ain-a</i>	<i>aif-a</i>	<i>haih-a</i>	<i>hiut-a</i>	<i>haut-a</i>	<i>keul-a</i>	<i>neur-a</i>
Aileu V.	<i>tael-a</i>	<i>aen-a</i>	<i>aif-a</i>	<i>haih-a</i>	<i>hiut-a</i>	<i>haut-a</i>	<i>keul-a</i>	<i>neur-a</i>
Hatu-B.	<i>tail-a</i>	<i>bani</i>	<i>aif-a</i>	<i>haih-a</i>	<i>heut-a</i>	<i>haut-a</i>	<i>keol-a</i>	<i>niur-a</i>
Liquidoe	<i>tael-a</i>	<i>ain-a</i>	<i>aif-a</i>	<i>hæh-a</i>	<i>hiut-a</i>	<i>haut-a</i>	<i>kiul-a</i>	<i>niur-a</i>
Railaco	<i>tael-a</i>	<i>aen-a</i>	<i>aɛp-a</i>	<i>heh-a</i>	<i>hiut-a</i>	<i>hato</i>	<i>gelo</i>	<i>nero</i>
Hatulua	<i>tail-a</i>	<i>aen-a</i>	<i>ep-a</i>	<i>heh-a</i>	<i>hito</i>	<i>hato</i>	<i>gelo</i>	<i>nero</i>
Barzatete	<i>tael-a</i>	<i>en-a</i>	<i>ɛp-a</i>	<i>heh-a</i>	<i>hito</i>	<i>hato</i>	<i>gelo</i>	<i>nero</i>
	‘rope’	‘bee’	‘fire’	‘pig’	‘star’	‘stone’	‘wind’	‘knife’

[†] Mambae Varieties are: South Mambae from Letefoho and Betano villages (Same sub-district) and Hatu-Udo sub-district, Central Mambae from the sub-districts of Laulara, Ailei Vila, Hatu-Builico and Liquidoe, and Northwest Mambae from the sub-districts of Railaco, Hatulua, and Barzatete. PMP reconstructions are from Blust & Trussel (ongoing). Proto-Mambae reconstructions are my own.

well as varieties part way between these two such as Letefoho in which all vowels usually undergo complete assimilation, apart from /i/ which lowers to /e/ after /a/.¹⁵ Another kind of vowel assimilation is height assimilation, seen in Hatu-Builico and Liquidoe in which penultimate mid vowels (optionally) raise to high before another high vowel after metathesis, such as in *neru → *niur-a* ‘knife’. Finally, Northwest Mambae has monophthongisation of the vowel sequence *ai created by metathesis. One example of is *hahi > *haih-a* > *heh-a* ‘pig’.¹⁶

¹⁵Table 2.6 only shows assimilation of high vowels. Assimilation of mid vowels also occurs, as seen in Hatu-Udo *mane* → *maan* ‘man, male’ and *lelo* → *leel* ‘sun’.

¹⁶More data will probably show that the best analysis of Northwest Mambae *heh-a* ‘pig’ and *ep-a* ‘fire’ is actually *heeh-a* and *eep-a* with an underlying sequence of two identical vowels. This is also likely for other apparent disyllables ending in /a/, such as Northwest Mambae [uta] ‘louse’ or [noa] ‘coconut’. The behaviour of other forms such as *tali* → *tail-a* ‘rope’ and *ai* → *ai-a* ‘tree’ which unambiguously undergo metathesis and/or preserve the original vowel sequence, as well as data from other varieties with the forms *utun*, *uut* ‘louse’ and *noo* ‘coconut’, strongly indicates that such forms are underlying *uut-a* and *noo-a* respectively.

2.3.8.4 Summary

There are many similarities between metathesis in Mambae and Amarasi. Of all the cases of metathesis discussed in this chapter, Mambae metathesis has the most similarities to Amarasi metathesis. Firstly, in both Mambae and Amarasi final /a/ also assimilates to the quality of the previous vowel after metathesis.

Secondly, in both Mambae and Amarasi metathesis interacts with the formation of nominal phrases. In Mambae non-final members of a nominal phrase tend to occur metathesised and final members tend to occur unmetathesised. In Amarasi this is not a tendency but a rule of the grammar. Amarasi metathesised nominals are a construct form used before attributive modifiers, and unmetathesised nominals are used phrase finally (Chapter 6).

Thirdly, in both Mambae and Amarasi U-forms are associated with nouns and M-forms with verbs. In Mambae this can be seen in derivationally related pairs such as *moir* ‘live’ and *mori* ‘life’. In Amarasi the default form of nominals is the U-form and the default form of verbs the M-form (§7.3).

Finally, metathesis in Northwest and Central Mambae is obligatory before the nominal suffix *-a*. Similarly, in Amarasi metathesis is obligatory before vowel-initial enclitics.

The only feature of Mambae metathesis which does not have a close parallel in Amarasi is the use of U-form nouns in direct possession in South Mambae. However, as discussed in §2.3.8.2.3 this feature, may be a recent development arising from loss of earlier genitive *-n*.

2.3.9 Helong

Helong is an Austronesian language spoken in the westernmost part of the island of Timor, and the neighbouring island of Semau (see Figure 2.1). Helong metathesis is described by Balle & Cameron (2012) and Balle (2015; 2017) who describe the Semau dialect, as well as by Steinhauer (1996b; 2008), who presents data from the Bolok dialect. In addition, I have carried out fieldwork on the Funai dialect as spoken in Oeletsala village, published as Edwards (2018b).¹⁷

2.3.9.1 Forms

Words in Helong have two forms, which I call the U-form and the M-form. In most cases the M-form is derived from the U-form by metathesis of the final CV

¹⁷There are three recognised dialects of Helong, Semau Helong is spoken on Semau island, while Funai Helong and Bolok Helong are spoken in Timor mainland

2.3 Survey of languages with synchronic metathesis

→ VC. Examples of each relevant vowel combination are given in (112) below. (Helong does not appear to have words in which the penultimate vowel is high and the final vowel mid, or in which the final vowel is high and the penultimate vowel mid.)

(112) Helong $V_1C_1V_2 \rightarrow V_1V_2C_1$ (Balle & Cameron 2012: 11, 33–52)

U-form	M-form	U-form	M-form
<i>nini</i>	→ <i>niin</i> ‘use’	<i>leko</i>	→ <i>leok</i> ‘beautiful’
<i>dani</i>	→ <i>dain</i> ‘song’	<i>lako</i>	→ <i>laok</i> ‘go’
<i>atuli</i>	→ <i>atuil</i> ‘person’	<i>sodo</i>	→ <i>sood</i> ‘greet’
<i>dehe</i>	→ <i>deeh</i> ‘some’	<i>susu</i>	→ <i>suus</i> ‘breast’
<i>dake</i>	→ <i>daek</i> ‘work’	<i>diku</i>	→ <i>diuk</i> ‘beat’
<i>one</i>	→ <i>oen</i> ‘they’	<i>lalu</i>	→ <i>laul</i> ‘palm-wine’
<i>klapa</i>	→ <i>klaap</i> ‘garden’		

Balle (2017: 47) also gives a handful of VCCV# words with metathesis of the final vowel across a consonant cluster: *banku* → *baunḡk* ‘bench’, *sampe* → *saemp* ‘until’, *bandu* → *baund* ‘authority’, and *saksi* → *saiks* ‘witness’. All these words are Malay loans with the exception of *bandu*, the etymology of which is unknown.

When the U-form ends in VC_a, the M-form in Semau Helong is described as being derived by deleting the final /a/, with the exception of words in which the penultimate vowel is also /a/ (such as *klapa* → *klaap* ‘garden’ in (112) above). Examples of such putative vowel deletion are given in (113) below.

(113) Semau Helong $V_{\alpha}Ca_{\beta} \rightarrow V_{\alpha}C$ (Balle & Cameron 2012: 13f)

U-form	M-form
<i>hida</i>	→ <i>hid</i> ‘promise’
<i>dela</i>	→ <i>del</i> ‘chair’
<i>doha</i>	→ <i>doh</i> ‘watch’
<i>uma</i>	→ <i>um</i> ‘house’

Similarly, Steinhauer (1996b; 2008), describes M-forms VC_a# final words as being derived by apocope, though in his description this also includes words whose penultimate vowel is /a/.

In Funai Helong the M-form of such words is derived by metathesis with assimilation of the final /a/ – the same process found in Mambae (§2.3.8) and most varieties of Meto. Examples are given in (114) below.

2 Synchronic metathesis from a cross-linguistic perspective

(114) Funai Helong $V_{\alpha}Ca \rightarrow V_{\alpha}V_{\alpha}C$

U-form		M-form	
<i>ina-ʔ</i>	→	<i>iin</i>	‘mother’
<i>koma</i>	→	<i>koom</i>	‘agree’
<i>mesa</i>	→	<i>mees</i>	‘one’
<i>uma</i>	→	<i>uum</i>	‘house’

When a stem ends in CVC# the M-form can be derived by CV → VC metathesis and deletion of the final consonant. Two examples are *unit* → *uin* ‘sugar’ and *paniŋ* → *pain* ‘give without concern’ (Balle 2017: 47). However, it appears that not all words which end in a consonant have distinct U-forms and M-forms.

Similarly, words which end in a vowel sequence do not seem to have distinct U-forms and M-forms. A number of such words do appear to have contracted forms which are shorter than the full form, however, the use of these contracted forms is not the same as the use of M-forms formed by metathesis or apocope.

2.3.9.2 Functions

All words which end in VCV are attested with both U-forms and M-forms in Helong. However, the function of each form varies according to the word class of the word in question. We can identify four different distributions of M-forms, three of which are morphological and one of which is phonological. For nouns M-forms mark specificity and the presence of an attributive modifier (§2.3.9.2.1), while for verbs M-forms mark imperfective aspect (§2.3.9.2.2) and with other word classes U-forms are used phrase finally and M-forms phrase initially and phrase medially (§2.3.9.2.3).

2.3.9.2.1 Nominal metathesis In the noun phrase metathesis marks specificity in Sema Helong. Examples are given in (115)–(117) below. In (115) the noun *buku* ‘book’ is in the U-form, and is non-specific. In sentence (116) the noun *buuk* ‘book’ is in the M-form and is specific, in (116) specificity is further marked by the specific demonstrative *nas*. Example (117) shows it is ungrammatical to use an M-form noun with the non-specific demonstrative *las*.

- (115) *kat buku enej.*
 take book\U six
 ‘Take (any) six books.’

2.3 Survey of languages with synchronic metathesis

- (116) *kat to~toan buuk enej n-a-s.*
 take RED~all book\M six SPEC-DEM-PL
 ‘Take all (of those) six books.’
- (117) * *kat to~toan buuk enej l-a-s*
 take RED~all book\M six NSPEC-DEM-PL
 ‘(Take all (of those) six books.)’ Balle (2015)

A similar example can be seen by comparing sentences (118) and (119) below. In (118) the unmetathesised noun *klapa* ‘garden’ agrees in specificity with the non-specific demonstrative *las*, while in (119) the same noun occurs metathesised agreeing with the specific demonstrative *na*.

- (118) *nol klapa l-a-s putin isin banan.*
 and garden\U NSPEC-DEM-PL produce contents good
 ‘And gardens produce good contents.’
- (119) *oen tama-s lako-s se klaap n-a.*
 3PL\M enter-PL go-PL ALL garden\M SPEC-DEM
 ‘They go into that garden.’ (Balle & Cameron 2012: 15)

When a noun occurs with a following modifier, the modifier occurs in the U-form or M-forms to signal the specificity of the noun. In both (120) and (121) below the specificity of the noun phrase is marked by the quantifier *dehe* ‘some’. In (120) this quantifier occurs in the U-form and the referent is non-specific, while in the equivalent example (121) it occurs in the M-form and has a specific referent.

- (120) *kat buku dehe.*
 take book\U some\U
 ‘Take some books.’
- (121) *kat buku deeh den n-i-a.*
 take book\U some\M from SPEC-PROX-DEM
 ‘Take some (of those) books from here.’ Balle (2015)

In the description of metathesis given by Steinhauer (1996b; 2008), metathesis is reported as affecting every non-final element in the noun phrase. Examples are given in (122) below. The change of medial /h/ → /s/ after metathesis is a phenomenon specific to the Bolok dialect.

2 Synchronic metathesis from a cross-linguistic perspective

(122) Bolok Helong noun + adj. → noun\M adj. (Steinhauer 1996b: 477)

<i>atuli</i>	+	<i>ηeŋo?</i>	→	<i>atuil ηeŋo?</i>	‘person + stupid’
<i>ale</i>	+	<i>kunis</i>	→	<i>ael kunis</i>	‘paddy + yellow’
<i>lelo</i>	+	<i>lima-?</i>	→	<i>leol lima?</i>	‘day + fifth’ = ‘Friday’
<i>blaho</i>	+	<i>muti?</i>	→	<i>blaos muti?</i>	‘mouse + white’
<i>bahi</i>	+	<i>mea</i>	→	<i>bais mea</i>	‘pig + red’

Steinhauer also identifies metathesis as marking the difference between attributive modifiers and predicative modifiers, as shown in (123) and (124) below. This description matches closely one of the functions of metathesis found in both Rotuman (§2.3.2.2) and Leti (§2.3.6.2).

(123) [NP *lelo*] [PRED *dene?*]
 sun\U go.down
 ‘The sun sets.’

(124) [NP *leol dene?*]
 sun\M go.down
 ‘west’ (Steinhauer 1996b: 477)

The functions of metathesis within the noun phrase as described by Steinhauer (1996b) is different to the function described by Balle & Cameron (2012). It is possible that these two descriptions of Helong metathesis differ due to each describing a different dialect of Helong. Balle & Cameron (2012) describe Semau Helong and Steinhauer (1996b) describes Bolok Helong.

In my Funai Helong data attributive modifiers normally trigger metathesis on CV# head nouns. Examples include *ale* ‘rice’ + *kpohot* ‘husk’ → *ael kpohot* ‘unhusked rice’ and *batu* ‘rock’ + *tlokon* ‘coral’ → *baut tlokon* ‘coral rock’. My Funai Helong data is currently insufficient to determine whether metathesis also marks specificity in this dialect.

To summarise, metathesis marks specificity in the Helong noun phrase and/or marks the presence of an attributive modifier. Marking of an attributive modifier is similar to the functions of metathesis in Rotuman, Leti, Roma, and Amarasi. Marking of specificity is similar to one of the functions of metathesis in Rotuman and Leti. In both Rotuman and Leti it is the (historically) metathesised form which is indefinite, while in Helong it is the *unmetathesised* form which is non-specific. Although a similar morphological process is used in each instance, the function of that morphological process in Helong is the opposite to that found in Rotuman and Leti.

2.3.9.2.2 **Verbal metathesis** Metathesis has two main distributions for verbs in Helong. Firstly, verbs are in the U-form when they do not take an object and in the M-form when they do take an object. This is similar to the use of M-forms in the noun phrase with an attributive modifier as described by Steinhauer (1996b).

Compare examples (125) and (126) below. In (125) the verb *dake* ‘work, do’ occurs in the U-form as there is no overt object. However, in example (126) there is an object and the verb takes the M-form.

- (125) *un lako dake.*
 3SG go\U work\U
 ‘S/he’s gone to (do some) work.’
- (126) *un lako daek kukis.*
 3SG go\U work\M cake
 ‘S/he’s gone to make cake.’ (Balle & Cameron 2012: 11)

The other use of metathesis on verbs is to mark aspect. U-forms mark perfective or completed aspect, while M-forms mark imperfective or progressive aspect. Compare the examples in (127)–(130) below. In examples (127) and (128) the verb *lako* ‘go’ is in the U-form and the sentence thus has perfective aspect. In examples (129) and (130), however, the verb *laok* is in the M-form, and each example is imperfective.

- (127) *un lako daek kukis.*
 3SG go\U work\M cake
 ‘S/he’s (already) left to make cake.’
- (128) *un lako daek kukis nol asii l-a?*
 3SG go\U work\M cake with who NSPEC-DEM
 ‘With whom has s/he (already) left to make cake?’
- (129) *un laok daek kukis.*
 3SG go\M work\M cake
 ‘S/he’s (in the process of) leaving to make cake.’
- (130) *un laok daek kukis nol asii l-a?*
 3SG go\M work\M cake with who NSPEC-DEM
 ‘With whom is s/he (in the process of) leaving to make cake?’

2.3.9.2.3 **Metathesis with other word classes** In addition to nouns and verbs, other word classes including adjectives, adverbs, “particles” and most pronouns

2 Synchronic metathesis from a cross-linguistic perspective

also have a U-form and an M-form. For these other word classes U-forms are (mostly) used phrase finally and M-forms are used phrase initially and phrase medially. This may be a case of phonologically conditioned metathesis. Examples of non-final adjectival M-forms are given in (132)–(134) below, which can be contrasted with the final U-form in (131).

- (131) *auk leko.*
1SG beautiful\U
'I'm beautiful.'
- (132) *auk leok dui.*
1SG beautiful\M more
'I'm more beautiful.'
- (133) *auk leok isi.*
1SG beautiful\M very\U
'I'm very beautiful.'
- (134) *auk leok baktetebes.*
1SG beautiful\M truly
'I'm truly beautiful.' (Balle & Cameron 2012: 12f)

Balle & Cameron (2012) give one exception to this pattern. This is the adverbial *ana lo* 'a lot, enough, exceptional(ly)'. This phrase is a conventionalised understatement, literally meaning 'not a little' and is formally a separate clause. Before this adverbial, an adjective occurs in the U-form. This is shown in (135) below.

- (135) *auk leko ana lo.*
1SG beautiful\U exceptionally
'I'm exceptionally beautiful.' (Balle & Cameron 2012: 12)

An example of a metathesised adverbial, *nabael* 'still' is given in (137) below. This can be contrasted with the unmetathesised and phrase-final *nabale* in (136).

- (136) *mo nahin n-a laŋa isi lo nabale.*
but meaning SPEC-DEM clear very NEG still\U
'But the meaning is still not very clear.'
- (137) *mo nahin n-a laŋa isi lo nabael tuun.*
but meaning SPEC-DEM clear very NEG still\M just
'But the meaning is just still not very clear.' (Balle & Cameron 2012: 13)

2.3 Survey of languages with synchronic metathesis

Finally, most of the pronouns have both U-forms and M-forms. The Semau Helong pronouns are given in Table 2.7 below. Note that despite the fact that the 2PL pronoun *mia* ends in a vowel sequence, it has an M-form, formed by deleting the final /a/. The 1SG pronoun *auk* does not have distinct U-forms and M-forms, however, it does have a shorter form *au*, which is used when the pronoun is an object. The form *auk* is used for 1SG subjects.¹⁸

Table 2.7: Semau Helong pronouns (Balle & Cameron 2012: 16)

	U-form	M-form
1SG	<i>auk</i>	<i>auk</i>
2SG	<i>ku</i>	<i>ku</i>
3SG	<i>una</i>	<i>un</i>
1PI	<i>kita</i>	<i>kit</i>
1PX	<i>kami</i>	<i>kaim</i>
2PL	<i>mia</i>	<i>mi</i>
3PL	<i>one</i>	<i>oen</i>

Examples of the U-form and M-form of the 3PL pronoun *one* are given in (138)–(140) below. In (138) the 3PL pronoun *one* is sentence final and thus occurs unmetathesised. In sentences (139) and (140) the same pronoun occurs non-finally and is thus in the M-form.

(138) *kaim lako-ŋ meo one.*
 1PL.EXCL\M go-1 visit 3PL\U
 ‘We’re going to visit them.’

(139) *oen lako-s meo in-ama-n n-u-a-s.*
 3PL\M go-PL visit parents-PL.GEN SPEC-REMOTE-DEM-PL
 ‘They’re going to visit their parents.’

(140) *tiata oen lako-s meo oen in-ama-n n-a-s.*
 so 3PL\M go-PL visit 3PL\M parents-PL.GEN SPEC-DEM-PL
 ‘So, they’re going to visit their parents.’ (Balle & Cameron 2012: 12)

¹⁸The Semau Helong 1SG subject pronoun *auk* is historically a result of reanalysis of the pronoun *au* followed by a 1SG verbal agreement prefix *k-*.

2 *Synchronic metathesis from a cross-linguistic perspective*

2.3.9.3 Summary

Formally, metathesis in Helong is associated with two other phonological processes: deletion of final /a/ in Semau and Bolok and assimilation of final /a/ in Funai. In terms of function, there are two kinds of metathesis in Helong. There is a process of phonological metathesis whereby non-final words which are neither verbs nor members of the noun phrase occur metathesised phrase medially. Metathesis is morphological for nouns and verbs. It marks specificity and/or the presence of an attributive modifier in the noun phrase and imperfective aspect in verbs.

There are two main similarities between metathesis in Helong and in Amarasi. Firstly, in each language words with a final /a/ do not follow the normal pattern of CV → VC metathesis. In particular, assimilation of final /a/ after metathesis occurs in both Funai Helong and Amarasi. Secondly, in both languages metathesis has different functions for nouns and verbs.

Even though Amarasi and Helong are immediate neighbours, the similarities between metathesis in each are fewer and less striking than the similarities between metathesis in Amarasi and Mambae or between Amarasi and Leti.

While much more work on the history of these languages is needed to properly understand why this is the case, one possible source could be to do with metathesis being manipulated (consciously or otherwise) as a marker of ethnic identity; when groups are in contact with one another there may be a greater imperative to differentiate between one another. Metathesis as marker of identity is explored in more detail in §8.2.

2.4 **Origins of synchronic metathesis**

In this section I discuss the origins of synchronic processes of metathesis, focussing on morphological metathesis. I begin in §2.4.1 with a discussion of the development of umlaut in the Germanic languages. In §2.4.2 I then discuss the ways in which morphological metathesis develops and show that its development closely parallels that of Germanic umlaut in many ways.

2.4.1 **Origins of umlaut**

In this section I provide an overview of the development of Germanic umlaut; a process with which readers are likely familiar. The way in which umlaut developed and became a morphological process has many similarities to the ways in which synchronic processes of metathesis develop and become morphological.

Umlaut is the term given to a vowel shift which happened in many of the Germanic languages and resulted in pairs such as English *foot* /fʊt/ ~ *feet* /fi:t/ and *mouse* /maʊs/ ~ *mice* /maɪs/. In these English examples the vowel of the plural forms is descended from an original rounded vowel which was fronted before a suffix with the front vowel /i/. This suffix was then lost but the front rounded vowel remained. The process is illustrated in (141) below. See Harbert (2007: 58ff) for an overview.

- (141) *mu:s > /maʊs/ *mouse*
 *mu:s-iz > *mu:s-i > *my:s-i > *my:s-ə > *my:s > *mi:s > /maɪs/ *mice*

In modern English umlaut is a purely morphological process with all trace of its original conditioning environment lost. However, this is not always the case. One language in which a phonologically conditioned process of umlaut developed into a morphological process in some environments but not in others is Old Norse. This is similar to metathesis in languages such as Rotuman, Helong, and Amarasi in which metathesis is a phonologically conditioned process in some environments and a morphological process in others.

In Old Norse there is a process of vowel shift known as *u*-mutation or *u*-umlaut. Under this process stressed /a/ → [ɔ] (transcribed <ɔ>) before /u/ and unstressed /a/ → /u/ before /u/. This process is formalised in (142) below. (Primary stress fails on the initial syllable in Old Norse.)

- (142) Old Norse *u*-umlaut:
 a → ɔ /'_(C)u
 → u /_(C)u
 → a elsewhere

When a suffix containing /u/ is attached to a stem with /a/, *u*-umlaut occurs. Examples include *stað*- 'place' + *-um* DAT.PL → *stǫðum* and *harm*- 'sorrow, grief' + *-um* DAT.PL → *hǫrmum* (Gordon 1957: 283,286). The declension of two weak feminine nouns is given in (143) below to further illustrate the productivity of the process.

- (143) Old Norse weak feminine declension (Gordon 1957: 289)

	SG	PL	SG	PL
NOM	<i>saga</i>	<i>sǫgur</i>	<i>stjarna</i>	<i>stjǫrnur</i>
ACC	<i>sǫgu</i>	<i>sǫgur</i>	<i>stjǫrnu</i>	<i>stjǫrnur</i>
GEN	<i>sǫgu</i>	<i>sagna</i>	<i>stjǫrnu</i>	<i>stjarna</i>
DAT	<i>sǫgu</i>	<i>sǫgum</i>	<i>stjǫrnu</i>	<i>stjǫrnum</i>
	'story'		'star'	

2 Synchronic metathesis from a cross-linguistic perspective

This phonological process also affects verbs. The conjugation of the verb *kalla* ‘to call’ is given in (144) to illustrate. This paradigm also shows examples of unstressed /a/ → /u/.

(144) Old Norse conjugation of *kalla* ‘to call’ (Gordon 1957: 305)

	PRESENT		PAST	
	ACTIVE	MIDDLE	ACTIVE	MIDDLE
1SG	<i>kalla</i>	<i>kǫllumk</i>	<i>kallaða</i>	<i>kǫlluðumk</i>
2SG	<i>kallar</i>	<i>kallask</i>	<i>kallaðir</i>	<i>kallaðisk</i>
3SG	<i>kallar</i>	<i>kallask</i>	<i>kallaði</i>	<i>kallaðisk</i>
1PL	<i>kǫllum</i>	<i>kǫllumk</i>	<i>kǫlluðum</i>	<i>kǫlluðumk</i>
2PL	<i>kallið</i>	<i>kallisk</i>	<i>kǫlluðuð</i>	<i>kǫlluðusk</i>
3PL	<i>kalla</i>	<i>kallask</i>	<i>kǫlluðu</i>	<i>kǫlluðusk</i>

With this data alone we would conclude that Old Norse *u*-umlaut is a purely phonologically conditioned process. However, there are also instances in which *u*-umlaut occurs where there is no following /u/. One example is in the nominative and accusative plurals of neuter nouns, two of which are given in (145) below.¹⁹ In fact, this single paradigm attests both phonologically conditioned and morphological instances of *u*-umlaut.

(145) Old Norse strong neuter declension (Gordon 1957: 283)

	SG	PL	SG	PL
NOM	<i>barn</i>	<i>bǫrn</i>	<i>land</i>	<i>lǫnd</i>
ACC	<i>barn</i>	<i>bǫrn</i>	<i>land</i>	<i>lǫnd</i>
GEN	<i>barns</i>	<i>barna</i>	<i>lands</i>	<i>landa</i>
DAT	<i>barni</i>	<i>bǫrnum</i>	<i>landi</i>	<i>lǫndum</i>
	‘child’		‘land’	

The best analysis of this Old Norse data is probably to posit a morphological process of *u*-umlaut to account for the neuter plural forms and posit a phonologically conditioned process of *u*-umlaut before suffixes with the vowel /u/.

In modern Icelandic the process of *u*-umlaut still occurs, as illustrated in the paradigm of *barn* /partn/ ‘child’ given in (146) below, and also seen in the verb *kalla* /k^hatla/ ‘call’ with the 1PL.PRES form *köllum* /k^hœtlʏm/ and the 1PL.PAST form *kǫlluðum* /k^hœtlʏðʏm/ (Hólmarsson et al. 1989: 43).

¹⁹Historically such forms had a suffix *-u*. This suffix had been lost by the time of Old Norse.

(146) Icelandic declension of *barn* /partn/ ‘child’ (Hólmarsson et al. 1989: 36)

	SG		PL	
NOM	<i>barn</i>	/partn/	<i>börn</i>	/pœrtn/
ACC	<i>barn</i>	/partn/	<i>börn</i>	/pœrtn/
GEN	<i>barns</i>	/partns/	<i>barna</i>	/partna/
DAT	<i>barni</i>	/partni/	<i>börnum</i>	/pœrtnum/

In Icelandic the phonological conditioning environment has become so opaque due to later processes including epenthesis of /u/ – e.g. *harmur* /harmyr/ ‘grief, sorrow’ (from Old Norse *harmr*) – that it is best to analyse *u*-umlaut as a morphological process in environments such as the neuter plural and as a morphemically conditioned process in other environments.

The development of Old Norse *u*-umlaut shows how a process which originally occurred only in certain phonological environments can develop into a morphological process. Old Norse has a single phonological process which is morphological in some environments and phonologically conditioned in other environments. Similarly, Icelandic has a single phonological process which is morphological in some environments and morphemically conditioned in other environments.

In §2.4.2 below I discuss some phonologically natural processes by which morphological metathesis can develop. Such pathways can result in some languages synchronically having a single process of metathesis which is phonologically conditioned in some environments and morphemically conditioned or morphological in other environments.

2.4.2 Historic origins of morphological metathesis

The most comprehensive account of the historic origins of metathesis is that of Blevins & Garrett (1998) with an updated, but shorter, account given in Blevins & Garrett (2004). According to this account there are three sources of metathesis: perceptual metathesis, compensatory metathesis, and metathesis which arises out of epenthesis and apocope (“pseudometathesis”). The examples of morphological metathesis discussed in this chapter are instances of epenthesis and apocope (§2.4.2.1) and/or compensatory metathesis (§2.4.2.2).

2.4.2.1 Epenthesis and apocope

One pathway by morphological metathesis can develop is through epenthesis and apocope. Languages which appear to have acquired metathesis in this way

2 Synchronic metathesis from a cross-linguistic perspective

include Leti (§2.3.6) and probably the north American Salishan languages (discussed in more detail in Appendix B).

Under this process, epenthesis of a vowel occurs in one part of a word and deletion of an original non-epenthetic vowel in another part of the word. One version of this process, which took place for Leti internal metathesis, is shown in (147) below. At stage 2 an epenthetic vowel is added word finally. The previous vowel is then deleted at stage 3 and at stage 4 the final epenthetic vowel is reinterpreted as non-epenthetic.

$$(147) \quad V_1C_2V_3C_4 > V_1C_2V_3C_4\check{V}_3 > V_1C_2C_4\check{V}_3 > V_1C_2C_4V_3$$

stage 1 stage 2 stage 3 stage 4

Each stage of this process is illustrated for Leti in Table 2.8 below. At stage 1 a word-final schwa is inserted, at stage 2 this schwa then either assimilates to the quality of the previous vowel or is lowered to /a/, finally at stage 3 the unstressed penultimate vowel is deleted, giving rise to the metathesised forms. Other developments such as consonant assimilation and glottal stop deletion with compensatory lengthening of the previous vowel then occurred at stage 3'. Proto-Malayo-Polynesian (PMP) reconstructions in Table 2.8 are from Blust & Trussel (ongoing). Stress is marked by an acute accent.

Table 2.8: Development of Leti metathesis (Blevins & Garrett 1998)

PMP	pre-Leti	stage 1	stage 2	stage 3	stage 3'	
*haŋin	> *ánin	> *áninə	> *ánini	> <i>anni</i>	'wind'	
*kulit	> *úlit	> *úlitə	> *úlit	> <i>ulti</i>	'skin'	
*kambu	> *ápun	> *ápunə	> *ápunu	> <i>apnu</i>	'belly'	
*likud	> *líʔur	> *líʔurə	> *líʔuru	> *líʔru	> <i>liiru</i>	'last'
*maqitəm	> *métam	> *métamə	> *métama	> <i>metma</i>	'red'	
*bulan	> *βúlan	> *βúlanə	> *βúlana	> *βúlna	> <i>bulla</i>	'moon'
*ŋajan	> *náʔan	> *náʔanə	> *náʔana	> *náʔna	> <i>naana</i>	'name'
*hikan	> *íʔan	> *íʔanə	> *íʔana	> *íʔna	> <i>iina</i>	'fish'

According to this account, epenthesis of final schwa only occurred in certain phonological environments, such as phrase finally, while no epenthesis occurred in other positions. Unmetathesised Leti forms are developments of the pre-Leti forms in Table 2.8 without the subsequent processes of epenthesis, assimilation, and deletion which yielded the metathesised forms.

This analysis can account for instances of Leti internal metathesis. However, recall from §2.3.6.1.4 that Leti also has external metathesis, seen, for instance, in *asu* ‘dog’ + *lalaβna* ‘big’ → *aslualaβne*. Such metathesis can be accounted for by compensatory metathesis, discussed in §2.4.2.2 below. Thus, *aslualaβna* ‘dog + big’ is hypothesised to have gone through the pathway **asulalaβna* > **asulualaβna* > **asūlualaβna* > *aslualaβna*.

Another probable case of metathesis developing by epenthesis and apocope occurred in the Salishan languages (§B.7), though in this case apocope was apparently motivated by stress shift. The various processes have been discussed by Demers (1974) who cites data from Lummi, a straits Salish variety closely related to both Saanich (§B.7.1) and Klallam (§B.7.2). Examples of Lummi metathesis are given in (148) below.

(148) Lummi metathesis (Demers 1974: 15)

	PERFECTIVE	→	IMPERFECTIVE	
‘Someone hit him’	<i>tsʼsə-tɥs</i>	→	<i>tsʼəs-tɥs</i>	‘He’s getting hit’
‘I smashed it’	<i>tʼsə-tsən</i>	→	<i>tʼəs-t</i>	‘He’s breaking it’
‘They gather it’	<i>qʼpə-ts</i>	→	<i>qʼəp-ɥ</i>	‘gathering’
‘I’m stuck’	<i>tʰʰqʷə-tsən</i>	→	<i>tʰʰəqʷ-sən</i>	‘I’m getting stuck’

Demers (1974) proposes that the imperfective is formed in all instances by infixation of a glottal stop, which is associated with a number of other rules. These processes are summarised in Table 2.9 below, for the metathesis of *tsʼsə* → *tsʼəs*- ‘hit’.

Table 2.9: Formation of Lummi (im)perfectives

process	PERFECTIVE	IMPERFECTIVE
1. base	<i>tsʼəsə-t-ɥ-s</i>	<i>tsʼəsə-t-ɥ-s</i>
2. infixation		<i>tsʼəʔsə-t-ɥ-s</i>
3. stress protraction	<i>tsʼəsə-t-ɥ-s</i>	
4. schwa deletion	<i>tsʼsə-t-ɥ-s</i>	<i>tsʼəʔs-t-ɥ-s</i>
5. glottal stop deletion		<i>tsʼəs-t-ɥ-s</i>

The first row gives the proposed underlying base forms. Each form has two vowels, with stress on the first vowel. The second row shows infixation of the glottal stop in the imperfective. In the third row so-called “stress protraction” occurs in the perfective, whereby stress moves over an obstruent to the adjacent

2 Synchronic metathesis from a cross-linguistic perspective

closed syllable. Stress protraction does not occur in the imperfective as the glottal stop is treated as a sonorant, and syllables closed by a sonorant maintain stress. In row four unstressed schwas are deleted and in row five any glottal stop before an obstruent is deleted, thus deleting the original marker of the imperfective.

In summary, Demers (1974) analyses (surface) metathesis in Lummi as resulting from glottal stop infixation followed by stress shift followed by unstressed schwa deletion followed by glottal stop deletion.

While such a combination of processes may be the historic source of metathesis in the Salishan languages, it does not seem possible to apply this analysis to the synchronic data in every language. In particular Blevins & Garrett (1998: 540) note that the Klallam data, in which roots containing vowels other than schwa also undergo metathesis, resists such a synchronic analysis (§B.7.2).²⁰

Vowel deletion in different environments also appears to be a likely source of metathesis in Tunisian Arabic, Ohlone, and Sierra Miwok. The synchronic data for these languages is discussed in Appendix B.

2.4.2.2 Compensatory metathesis

Compensatory metathesis is a process of metathesis which arises through anticipatory co-articulation of an unstressed vowel with the stressed vowel, followed by reduction and eventual loss of the unstressed vowel. In §4.5 I present evidence showing that Amarasi metathesis probably developed via this route. The progression of this process is shown in (149) below, illustrated with Rotuman *pure* → *puer* ‘rule, decide’.²¹

(149)	púre	púere	púerě	púer
	\check{V}_1CV_2	$\check{V}_1V_2CV_2$	$\check{V}_1V_2C\check{V}_2$	\check{V}_1V_2C
	stage 1	stage 2	stage 3	stage 4

There is direct evidence that this process has occurred in Kwara’ae (§2.3.1) as intermediate stage 3 forms are still attested in certain environments (§2.3.1.1.5). While there is no direct evidence that this is the process which occurred in Rotuman, Blevins & Garrett (1998) argue that the distribution of metathesised forms in Rotuman is consistent with their account.

²⁰Blevins & Garrett (1998: 540) do, however, compare Klallam $\chi f' i-t \rightarrow \chi i f'-t$ ‘scratch’ to Lushootseed $\chi'' i f' i-d$ ‘mark it, plough land’ and $\chi'' i f'-dup$ ‘I’m ploughing now’, citing data from Bates et al. (1994).

²¹While I only discuss examples of this process operating from the right edge of a word, it can also operate from the left edge of a word. Blevins & Garrett (1998: 537) discuss the case of Ngkoḷ (Pama-Nyungan, Australia) in which left edge metathesis has occurred historically.

This distribution is the observation provided by Hale & Kissonck (1998) (§2.3.2.2) that M-forms mostly occur before polysyllabic suffixes while U-forms occur before monosyllabic suffixes. This is combined with the fact that stress regularly falls on the penultimate syllable of a word in Rotuman and that some affixes count as part of the word for stress placement, while other affixes do not (Churchward 1940: 75).

Due to penultimate stress, stems with a monosyllabic suffix were stressed on the stem-final vowel, and such vowels were “protected” from the co-articulation and weakening which affected final unstressed vowels elsewhere. This resulted in the U-form surviving before monosyllabic suffixes, with M-forms occurring elsewhere. The different development of isolated stems, stems with a monosyllabic suffix, and stems with a polysyllabic suffix in Rotuman are given in (150) below.

(150) Development of metathesis in Rotuman (Blevins & Garrett 1998: 532)

	stage 1	>	stage 2	>	stage 3	>	stage 4
∅	Ṽ ₁ CV ₂	>	Ṽ ₁ V ₂ CV ₂	>	Ṽ ₁ V ₂ CṼ ₂	>	Ṽ ₁ V ₂ C
-σ	V ₁ CṼ ₂ -σ	>	V ₁ CṼ ₂ -σ	>	V ₁ CṼ ₂ -σ	>	V ₁ CṼ ₂ -σ
-σσ	Ṽ ₁ CV ₂ -σσ	>	Ṽ ₁ V ₂ CV ₂ -σσ	>	Ṽ ₁ V ₂ CṼ ₂ -σσ	>	Ṽ ₁ V ₂ C-σσ

In modern-day Rotuman metathesis not only occurs before certain suffixes, but is also a morphological process marking a definite/indefinite contrast. The final step for this development was for the suffix marking definiteness to be lost. This suffix was probably originally a monosyllabic copy vowel (Grace 1959; Blevins & Garrett 1998). The presumed development for the word *pure* → *puer* ‘rule, decide’ is shown in (151) below.

(151) -∅ *púre > *púere > *púerě > *púer > *púer*
 -V *puré-e > *puré-e > *puré-ě > *puré > *púre*

Compensatory metathesis with subsequent loss of the conditioning environment is one way in which a language can develop a morphological process of metathesis. The distribution of M-forms and U-forms in Rotuman, Helong, and Mambae appears to be consistent with such a process. In Amarasi there is comparative evidence attesting the posited intermediate forms (§2.4.2).

Metathesis can thus arise in a language in a specific phonological environment through a series of phonetically natural changes, in a similar manner to the development of umlaut in the Germanic languages. As with Germanic umlaut, when the original conditioning environment is lost, metathesis can become the only expression of a morphological process.

2.5 Forms of synchronic metathesis

In this section I summarise some common features in the forms of synchronic metathesis among the languages discussed in this chapter which also occur with metathesis in Amarasi: the prevalence of consonant-vowel metathesis among languages in which metathesis has a morphological function and the existence of associated phonological processes.

2.5.1 Consonant-vowel metathesis

The only kind of metathesis known to develop a morphological function is that of adjacent consonants and vowels; either $CV \rightarrow VC$ or $VC \rightarrow CV$. No instances of vowel-vowel or consonant-consonant metathesis are known to be morphological, though the latter does occur as an automatic phonological process (§2.2.1). Furthermore, instances of morphological metathesis discussed in this chapter can all be located with respect to a stressed vowel, the word edge, or both.

These two facts arise from the historic development of metathesis, as summarised in §2.4. The non-existence of morphological processes of consonant-consonant or vowel-vowel metathesis is also connected with the development of such processes. There does not currently appear to be any series of phonetically natural changes whereby such a process could develop.

Under compensatory metathesis (§2.4.2.2) the crucial step in the development of true synchronic metathesis is weakening and loss of an unstressed vowel. This accounts for instances of metathesis which are located with respect to stress. Similarly, under pseudo-metathesis (epenthesis and deletion, §2.4.2.1) the only (known) attested cases which have developed into true metathesis are those in which an epenthetic vowel has been added to a word edge. This accounts for instances of metathesis which are located with respect to a word edge.

Synchronic accounts of metathesis should take into consideration the history of these processes. Thus, descriptions of languages in which metathesis developed after stressed syllables should include this fact in any description of the synchronic process. A rule such as $CV \rightarrow VC / \acute{V} _$ achieves this by including the stressed syllable as a constraining environment. Likewise, in languages in which metathesis developed by epenthesis and apocope should be informed by the fact that metathesis only developed at word edges. Again, a rule such as $VC \rightarrow CV / _ \#$ achieves this by constraining metathesis to the word edge.

2.5.2 Associated phonological processes

Synchronic consonant-vowel metathesis is typically associated with other processes. In some cases these processes co-occur with metathesis, and in others they occur instead of metathesis for words of a particular phonotactic shape.

There are two reasons why metathesis is usually associated with other processes. Firstly, in cases such as Leti, morphological metathesis has developed through the accumulation of a number of different processes (§2.4.2), with some of these processes still being attested alongside metathesis in certain phonotactic or phonological environments.

Secondly, in cases such as Mambae and Rotuman, it is the metathesis itself which triggers other phonological processes. These processes are a response to the new phonological shape of the stem created through metathesis, such as assimilation of newly adjacent vowels. These are the kinds of processes associated with metathesis in Amarasi.

2.6 Functions of morphological metathesis

In this section I summarise the functions of metathesis in the languages discussed in this chapter. When it has developed into a morphological process, metathesis has uses which are unsurprising for a morphological process and which are found with other more familiar morphological processes such as affixation.

Table 2.10: Functions of morphological metathesis

Language	Verbs	Nouns	
Bunak	agreement	n./a.	
Rotuman	imperfective	indefinite	modified
Leti	imperfective	indefinite	modified
Roma		subject	unmodified
Mambae	nominalisation		modified, possessed
Helong	imperfective	definite	modified
Amarasi	unresolved		modified

The different functions associated with morphological metathesis in languages discussed in this chapter are summarised in Table 2.10. Kwara'ae (§2.3.1), Wersing (§2.3.3), and Luang (§2.3.5) are not listed in Table 2.10 as metathesis in these languages is analysed as phonologically conditioned.

2 Synchronic metathesis from a cross-linguistic perspective

In addition to the morphological functions of metathesis listed in Table 2.10, metathesis in a number of these languages is also phonologically conditioned in some environments. This is the case for Rotuman, Helong, and Amarasi. In this respect, these languages are similar to Old Norse *u*-umlaut (§2.4.1) in which a single phonological process is phonologically conditioned in some environments and morphological in other environments.

Table 2.10 shows that Rotuman and the languages of the greater Timor region use morphological metathesis to mark fairly typical morphological categories. Two common functions are to mark aspect on verbs and definiteness in the noun phrase. Additionally, Rotuman and every language of the greater Timor region with morphological metathesis uses it to express the presence or absence of an attributive modifier in the noun phrase. This is the only function of morphological metathesis in the noun phrase in Amarasi. The morphological form used to mark the presence of an attributive modifier is known as the construct form and I include a brief overview of this function in §2.6.1 below.

2.6.1 Metathesis as a construct form

Morphological metathesis is frequently used as a construct form. The construct form (also *construct state* or *annexed state/form*) is a morphological form best known in the Semitic languages. It is a form used to mark the head-dependent relationship between two members of a syntactic phrase, usually by a special morphological form taken by the head of that phrase.

One language with a construct form is Syrian Arabic, in which two nouns can stand in juxtaposition with the head noun in the construct form. Most such Syrian Arabic noun phrases can be compared to English compound nouns or genitive constructions. In Syrian Arabic the construct form is marked by the suffix *-(e)t*. Examples of the Syrian Arabic construct form are given in (152).

(152) Syrian Arabic construct form (Cowell 1964: 163)

Absolute	Construct
<i>ħafle</i> ‘show’	<i>ħafle-t mu:si:qa</i> ‘concert (<i>lit.</i> music show)’
<i>ħza:ne</i> ‘closet’	<i>ħza:ne-t ʔu:d^ʔt^ʔi</i> ‘the closet of my room’
<i>masʔale</i> ‘matter’	<i>masʔale-t zadd</i> ‘a matter of concern’
<i>ħa:le</i> ‘condition’	<i>ħa:le-t əf-ʔərke</i> ‘condition of the company’
<i>zja:ra</i> ‘visit’	<i>zja:r-et ʔaxi</i> ‘my brother’s visit’
<i>ʔəs^ʔ:a</i> ‘story’	<i>ʔəs^ʔ:-et^ʔ haz-zalame</i> ‘that fellow’s story’
<i>ʔu:d^ʔa</i> ‘room’	<i>ʔu:d^ʔ-et^ʔ əl-ʔaʔde</i> ‘sitting room’
<i>waz^ʔi:fe</i> ‘assignment’	<i>waz^ʔi:f-t əl-fi:zja</i> ‘physics assignment’

In Iraqw (Cushitic, Tanzania) the construct form occurs with a wider variety of nominal modifiers including nouns, adjectives, numerals, and relative clauses. The construct form in Iraqw is signalled by a suffix which agrees with the gender of the noun to which it attaches. Examples of the construct form in Iraqw are given in (153) below. All construct suffixes have a high tone in Iraqw.

(153) Iraqw construct form (Mous 1993: 94)

Stem		Gender	Construct	
<i>ts'axwel</i>	'trap'	MASC	<i>ts'axwel-ú dan^w</i>	'elephant trap'
<i>kuru</i>	'year'	MASC1	<i>kur-kú</i>	<i>ʕisá?</i> 'last year'
<i>waahla</i>	'python'	FEM	<i>waahlá-r ur</i>	'a big python'
<i>ga</i>	'thing'	FEM	<i>gá-r ni hláa?</i>	'the thing that I want'
<i>difi</i>	'fat'	FEM1	<i>difi-tá</i>	<i>ʕáwak</i> 'cream (<i>lit.</i> white fat)'
<i>ħar</i>	'stick'	FEM1	<i>ħar-tá</i>	<i>baabúʕée?</i> 'the stick of my father'
<i>giʕi</i>	'ghost'	NEUT	<i>giʕ-á</i>	<i>heedá?</i> 'the ghost of that man'

In Tolaki (Austronesian, Sulawesi) it is unmodified nouns which are morphologically marked, while the construct form is unmarked. This is similar to the function of metathesis in Roma (§2.3.7). In Tolaki all two syllable nouns obligatorily occur with the prefix *o-*, except when another adjective or noun occurs within the noun phrase.

Compare example (154) and (155) below. Each of these examples consists of a demonstrative, noun, and adjective. In (154) the prefix *o-* occurs, and the following adjective is interpreted as predicative, while in (155) this prefix does not occur and the following adjective is interpreted as attributive.

(154) *ŋgituʔo* [_{NP} *o-tina*] *momahē*
 DEM woman beautiful
 'That woman is beautiful.'

(155) *ŋgituʔo* [_{NP} *tina momahē*]
 DEM woman beautiful
 'that beautiful woman'

A number of other Tolaki nominal phrases are given in Table 2.11. For all such phrases the citation (unmodified) form of each element is also given. When this word is a disyllabic noun it occurs with the prefix *o-*.²²

²²The Tolaki prefix *o-* has a restricted phonological distribution, only occurring on two syllable nouns. See van den Berg (2012) for a discussion and analysis of this phonological restriction based on an earlier interpretation of the Tolaki data.

2 Synchronic metathesis from a cross-linguistic perspective

Table 2.11: Tolaki nominal phrases (own fieldnotes)

	Noun		Mod.		Phrase	
‘dog’	<i>o-dahu</i>	+	<i>oβose</i>	‘big’	→	<i>dahu oβose</i> ‘(a) big dog’
‘table’	<i>o-meda</i>	+	<i>momea</i>	‘red’	→	<i>meda momea</i> ‘(a) red table’
‘hair’	<i>o-βuu</i>	+	<i>mokuni</i>	‘yellow’	→	<i>βuu mokuni</i> ‘blond hair’
‘eye’	<i>o-mata</i>	+	<i>me?eto</i>	‘black’	→	<i>mata me?eto</i> ‘pupil’
‘tooth’	<i>o-ηisi</i>	+	<i>o-hada</i>	‘monkey’	→	<i>ηisi hada</i> ‘canine tooth’
‘hair’	<i>o-βulu</i>	+	<i>o-mata</i>	‘eye’	→	<i>βulu mata</i> ‘eyelashes’

The construct form is a morphological form used to mark a head-dependent relationship between two members of a syntactic phrase. Such a morphological category is not at all rare in languages of the world. There is no fundamental functional difference between metathesis marking a construct form in a language like Leti and the suffix *-(e)t* marking the construct form in Syrian Arabic. The only difference is in the form of the morphology; metathesis in one case and suffixation in the other. Use of metathesis to mark a head-dependent relationship requires no special model of interaction between morphology and syntax beyond that which is required for any model of attributive marking. See Rieβler (2016: 15–22) for a discussion of the syntax-morphology interface within the context of attributive marking.

What is surprising is that every language of the greater Timor region (as well as Rotuman in the Pacific) with morphological metathesis uses it to mark a construct form. The reason for this is at least partly connected with the historic development of metathesis in these languages. As discussed by Blevins & Garrett (1998) and summarised in §2.4.2.2, metathesis in these languages originally arose only in certain phonological environments, and only affected unstressed syllables.

In Amarasi, for instance, the final member of a syntactic phrase bears the main phrasal stress while non-final members bear secondary stress (§3.3.4). This then creates an environment in which the processes which ultimately give rise to metathesis are most likely to occur. Such phonologically conditioned metathesis has then developed into a morphological process.

2.7 Conclusions

In this chapter I examined synchronic metathesis from a cross-linguistic perspective. I identified three kinds of synchronic metathesis: phonologically conditioned, morphemically conditioned, and morphological. I surveyed the languages of the greater Timor region for which synchronic metathesis has been described, as well as Kwara'ae and Rotuman in the Pacific.

I showed that metathesis often resists a unitary analysis and that for several languages a single process of metathesis may be phonologically conditioned in some environments, but morphological in other environments. Furthermore, when morphological, a single process of metathesis may have multiple functions. Both these facts hold for Amarasi in which metathesis is phonologically conditioned in one environment (Chapter 5) and has two distinct morphological functions (Chapters 6 and 7).

In this chapter I have summarised the origins, forms, and functions of synchronic metathesis and showed that there is no fundamental difference between metathesis and other morphological processes. In particular, the development of synchronic metathesis has several parallels to the development of other non-concatenative processes such as umlaut in the Germanic languages. This typological perspective sets the scene for the detailed description and analysis of Amarasi metathesis which constitutes the rest of this book.

3 Phonology and phonotactics

3.1 Introduction

In this chapter I provide a detailed description of Amarasi phonology, phonotactics, prosodic structures, and morphophonemics. Amarasi has a highly constrained word structure built off a CVCVC foot.

My discussion proceeds roughly from the smallest units to the largest units. In §3.2 I describe the segmental inventory. In §3.3 I describe the prosodic structures of Amarasi: the syllable, the disyllabic foot, and the prosodic word. I describe the structure of roots in §3.4. I also discuss the process of (optional) epenthesis before consonant clusters (§3.5), two processes of word-final consonant deletion (§3.6), and the morphophonemics associated with enclitics (§3.7).

3.2 Segmental inventory

3.2.1 Vowel inventory

Amarasi has five contrastive vowels. All lexical roots contain at least two vowels. These five vowels are given in Table 3.1 below, with their usual phonetic realisation given in Table 3.1b.

Table 3.1: Amarasi vowels

(a) Broad transcription				(b) Narrow transcription			
	Front	Cent.	Back		Front	Cent.	Back
High	<i>i</i>		<i>u</i>	High	i		ʊ
Mid	<i>e</i>		<i>o</i>	Mid	ɛ		ɔ
Low		<i>a</i>		Low		a	

The vowel /a/ is low and slightly front. In post stress position it is usually centralised to [ɐ], in other word positions it is realised as [a], though centralised

3 Phonology and phonotactics

realisations are also sometimes heard in pre-stress position. Examples of this allophony are given in (1) below.

(1) /a/ → [ɐ] /'σ_

<i>nua</i>	[ˈnʊɐ]	🔊	‘two’
<i>nima</i>	[ˈnimɐ]	🔊	‘five’
<i>ama-f</i>	[ˈʔamɐf]	🔊	‘father’
<i>kofaʔ</i>	[ˈkɔfɐʔ]	🔊	‘boat’

3.2.1.1 Mid vowels

The mid vowels /e/ and /o/ are usually realised as mid-low [ɛ] and [ɔ] respectively. They have mid-high allophones [e] and [o] when followed by a high vowel in the same word.¹ This raising is most pronounced for /o/ before labial phonemes, and most pronounced for /e/ before /s/ and /k/. Examples are given in (2) below.

(2) V[-HIGH,+MID,+LOW] → V[+HIGH,+MID] / _(C)V[+HIGH,-MID]

<i>a/n-reruʔ</i>	[ʔanˈdrerʊʔ]	🔊	‘is tired’
<i>betiʔ</i>	[ˈβetiʔ]	🔊	‘fried’
<i>koʔu</i>	[ˈkoʔʊ]	🔊	‘big’
<i>ori-f</i>	[ˈʔorɪf]	🔊	‘younger sibling’

In some words a kind of vowel harmony operates in which an initial mid vowel is raised to mid-high and a final high vowel is also lowered to mid-high. Such pronunciations are identified by my consultants as specific to Koro’oto hamlet. Examples are given in (3) below. The conditions under which this vowel harmony operates are not yet fully understood, though could be partially connected with the quality of the consonants of the word.

(3) V[-HIGH,+MID,+LOW]CV[+HIGH,-MID] → V[+HIGH,+MID]CV[+HIGH,+MID]

<i>besi</i>	[ˈbese]	🔊	‘knife’
<i>kreni</i>	[ˈkrene]	🔊	‘ring’
<i>kobi</i>	[ˈkoβe]	🔊	‘cabbage’
<i>tainonus</i>	[tajˈnonos]	🔊	‘earthquake’





There is also at least one word which has a final mid-high vowel, *enus* → [ˈʔɛnos] 🔊 ‘rainbow’. In the metathesised form of this word the second vowel

¹While this is the most common realisation of these phonemes in this environment, the mid allophones [ɛ] and [ɔ] are also sometimes heard before high vowels.

is high, *enus*+*ee* → *euns=ee* → [ʔɛʊnsɛ] . This appears to be a case of high vowel lowering in closed syllables.²





When a vowel-initial enclitic attaches to a vowel-final host, the final vowel conditions insertion of a consonant. The consonant /ɖʒ/ is inserted after the front vowels /i/ and /e/ and /gw/ is inserted after the back vowels /u/ and /o/. The clitic host then undergoes metathesis and the vowel which conditioned insertion of the consonant assimilates to the quality of the previous vowel. This process is discussed in full detail in §5.3 Four examples are given in (4) below.

- (4) V[+MID](C)V[-HIGH] + =V → V[+MID]V[+MID](C)C=V

<i>n-fee</i>	+	<i>=ee</i>	→	<i>n-feeɖʒ=ee</i>	→	[nʔfɛ:ɖʒɛ]		‘gives it’
<i>oe</i>	+	<i>=ee</i>	→	<i>ooɖʒ=ee</i>	→	[ʔɔ:ɖʒɛ]		‘the water’
<i>nefo</i>	+	<i>=ee</i>	→	<i>neefgw=ee</i>	→	[nɛːfɣwɛ]		‘the lake’
<i>oo</i>	+	<i>=ee</i>	→	<i>oogw=ee</i>	→	[ʔɔ:ɣwɛ]		‘the bamboo’

When the penultimate vowel of the clitic host is a mid vowel which has been raised to mid-high before a high vowel, the mid-high allophone is usually preserved after consonant insertion and vowel assimilation. Examples are given in (5) below.

- (5) V[+MID,+HI](C)V[+HI] + =V → V[+MID,+HIGH]V[+MID,+HI](C)C=V

<i>krei</i>	+	<i>=ee</i>	→	<i>kreeɖʒ=ee</i>	→	[kʔre:ɖʒɛ]		‘the church/week’
<i>n-romi</i>	+	<i>=ee</i>	→	<i>n-roomɖʒ=ee</i>	→	[nɔɾɔːmɖʒɛ]		‘likes it’
<i>mepu</i>	+	<i>=ee</i>	→	<i>meeɣw=ee</i>	→	[mɛːpɣwɛ]		‘the work’
<i>noɸu</i>	+	<i>=ee</i>	→	<i>nooɣw=ee</i>	→	[nɔɔpɣwɛ]		‘the grave’

All these facts indicate that Koro'oto Amarasi is probably either in the process of acquiring a seven vowel system, or is in the process of losing an original seven vowel system.³

²In the case of *enus* → [ʔɛnos] ‘rainbow’, my main consultant, Heronimus Bani (Roni), had independently chosen to write this word orthographically as <enous> in the Amarasi Bible translation. When I noticed this and asked him about it, he explained that he did this because the vowel “has the sound both of *o* and *u*.”

³Some varieties of Meto are further along the pathway to a full seven vowel system. This is partly due to the complete assimilation after metathesis seen in these varieties (discussed in §4.2.2.2), seen for instance in Naitbelak Amfo'an in which *na-leko* ‘is good’ metathesises to [naɛ:k] with open-mid [ɛ] while *na-henu* ‘is full’ metathesises to [naːhɛ:n] with close-mid [ɛ]. See also the discussion in Steinhauer (1993; 1996a,b; 2008) who adopts a seven vowel analysis for his Miomafo data.

3 Phonology and phonotactics

3.2.1.2 High vowels

The high front vowel /i/ has a lower allophone [ɪ] in several environments: before the fricative /f/, before a voiceless alveolar consonant followed by a high vowel, after a voiceless alveolar consonant which is preceded by a front vowel, and when preceding a stressed syllable. It also tends to be slightly lower when it occurs after the alveolar fricative /s/. This rule is given with examples in (6) below.

(6) /i/ → [ɪ]

/ _f	<i>bifee</i>	[bɪfɛ:]	☞	‘woman’
	<i>nui-f</i>	[nʊɪf]	☞	‘bone’
/ _{s,t}V[+HI]	<i>hitu</i>	[hɪtʊ]	☞	‘seven’
	<i>sisɪ</i>	[sɪsɪ]	☞	‘flesh’
/{s,t}V[+FR]_	<i>nisɪf</i>	[nɪsɪf]	☞	‘tooth’
	<i>sisɪ</i>	[sɪsɪ]	☞	‘flesh’
/ _'σ	<i>bikaseʔ</i>	[bɪ'kaseʔ]	☞	‘horse’
	<i>riʔanaʔ</i>	[rɪ'ʔaneʔ]	☞	‘child’
/s_	<i>siʔu-f</i>	[sɪʔʊf]	☞	‘elbow’
	<i>masɪk</i>	[masɪk]	☞	‘salt’

The environments in which /i/ is realised as [ɪ] do not form a natural class and it does not seem possible to unify them into a more general environment such as “in (unstressed) closed syllables”. Examples of unstressed realisations of /i/ as [ɪ] in closed syllables include *betiʔ* → [βɛtɪʔ] ☞ ‘fried’ and *a/n-toit* → [ʔan'tɔitɪ] ☞ ‘asks’. The high back vowel /u/ is realised as [ʊ] in all environments. Examples include *uki* → [ʔʊkɪ] ☞ ‘banana’ and *uran* → [ʔʊrɛn] ☞ ‘rain’.

3.2.1.3 Vowel type frequencies

A count of the frequency of each vowel was carried out on my current dictionary of 2,005 unique roots (including bound morphemes). This yielded a total of 4,368 vowels, the frequencies of which are given in Table 3.2.

Table 3.2: Vowel frequencies

V	<i>i</i>	<i>e</i>	<i>a</i>	<i>o</i>	<i>u</i>
no.	730	771	1,373	701	793
	17%	18%	31%	16%	18%

As Table 3.2 shows, the vowel /a/ is nearly twice as frequent as each other vowel. The vowel /a/ is also the vowel inserted epenthetically to break up clusters of more than two consonants (§3.5), and it can be considered the default vowel.

3.2.1.4 Vowel sequences

Amarasi allows a maximum of two vowels to surface adjacent to one another. Every sequence of two vowels occurs in Amarasi, with the exception of a high vowel followed by a mid vowel. Attested sequences are given in Table 3.3 below, with frequencies in my dictionary of 2,005 unique roots given in Table 3.3b. All the sequences given in Table 3.3, with the exception of /ou/, have been attested in underlying U-forms. That is, only the sequence /ou/ has so far been attested exclusively in metathesised words.

Table 3.3: Amarasi vowel sequences

(a) Attested vowel sequences							(b) Frequencies						
V ₁ ↓	i	e	a	o	u	V ₂ ←	V ₁ ↓	i	e	a	o	u	V ₂ ←
i	<i>ii</i>		<i>ia</i>		<i>iu</i>		i	16		9		11	
e	<i>ei</i>	<i>ee</i>	<i>ea</i>	<i>eo</i>	<i>eu</i>		e	16	32	5	27	13	
a	<i>ai</i>	<i>ae</i>	<i>aa</i>	<i>ao</i>	<i>au</i>		a	75	43	31	19	49	
o	<i>oi</i>	<i>oe</i>	<i>oa</i>	<i>oo</i>	<i>ou</i>		o	19	39	7	42		
u	<i>ui</i>		<i>ua</i>		<i>uu</i>		u	17		35		30	

One distinctive phonetic feature of both varieties of Meto spoken around the Amarasi area is centralisation of /a/ when followed by a high vowel. This is most common in the sequence /au/, but does also sometimes occur in the sequence /ai/. This centralisation does not affect sequences of /au/ or /ai/ resulting from metathesis. Examples are given in (7) below.

(7) /a/ → [ə] / _V[+HIGH]

<i>sekau</i>	[sɛ'kəw]	🔊	'who'
<i>nautus</i>	[nəwʈʊs]	🔊	'BEETLE; CYCLONE'

Alternately, the first element of the sequence /ai/ is often fronted to [ɛ]. These sequences are generally kept distinct from underlying sequences of /e+/i/, which are usually realised as [ei] according to the regular rule of mid vowel raising

3 Phonology and phonotactics

before high vowels (see rule (2) on page 92). Raising of /a/ to [ɛ] before /i/ does not occur in careful speech. The examples in (8) below were extracted from texts.

(8) /a/ → [ɛ] / _i

<i>n-murai</i>	[n̄m̄ɔ'rej]	▶▶	'begins'
<i>mainuan</i>	[mɛj'nɔvɛn]	▶▶	'open(ness), freedom'

The second vowel of sequences beginning with /i/ is often fronted. This might only happen before apical consonants, seen in (9) before the voiceless apical sibilant /s/.

(9) /V/ → [V̥] / i_

<i>a/n-kius</i>	[ʔan'kiʰs]	▶▶	'sees'
<i>a/n-kias</i>	[ʔan'kiæ̃s]	▶▶	'sees' (see §3.2.1.4.2)

The mid-back vowel /o/ often dissimilates in backness and rounding from a following high vowel. This results in either a centralised rounded or unrounded vowel, as conditioned by the rounding quality of the following high vowel:

(10) /o/ → [β_{BACK}, β_{ROUND}] / _V[+HIGH, α_{BACK}, α_{ROUND}]

<i>a/n-toit</i>	[ʔan'tɔit̚]	▶▶	'asks'
<i>a/n-toup</i>	[ʔan'tɔ̃p̚]	▶▶	'receives'

3.2.1.4.1 Double Vowels In normal speech a sequence of two identical vowels always coalesces into a single phonetic syllable with a single phonetically long or half-long vowel. Examples are given in (11) below.

(11) /V_αV_α/ → [V:]

<i>a/n-sii</i>	[ʔan'si:]	▶▶	'sings'
<i>fee</i>	[fɛ:]	▶▶	'wife'
<i>haa</i>	[ha:]	▶▶	'four'
<i>oo</i>	[ʔɔ:]	▶▶	'bamboo'
<i>tuu-f</i>	[tɔ̃f]	▶▶	'knee'

An alternate analysis of such data would be to propose that sequences of two identical vowels are underlyingly long vowels; that is a single vowel linked to two morae. Each of these analyses is shown below in for *fee* 'wife' in (12) and (13) respectively.

(12) Analysis 1: /fee/ ‘wife’



(13) Analysis 2: /fe:/ ‘wife’



The reason for analysing such data as representing a sequence of two identical vowels rather than a single long vowel, is that, with the exception of their phonetic realisation, sequences of two identical vowels behave identically in every respect to sequences of two different vowels. This is true of stress assignment (§3.3.4), reduplication (§3.3.5) and every other process of the language.

One process which illustrates well the fact that sequences of two identical vowels behave identically to sequences of two different vowels is glottal stop infixation whereby the second part of each of the nominalising circumfixes *ma...-ʔ* ‘property nominalisation’ (§A.2.2) and *ʔ...-ʔ* ‘object nominalisation’ (§A.2.3) occurs as an infix between the vowels of a final vowel sequence. Examples are given in (14) below.

(14) Circum-/Infixes *ʔ...-ʔ* and *ma...-ʔ*

‘covers’	<i>n-neo</i>	+	<i>ʔ...-ʔ</i>	→	<i>ʔ-neʔo</i>	‘umbrella’
‘writes’	<i>n-tui</i>	+	<i>ʔ...-ʔ</i>	→	<i>ʔ-tuʔi</i>	‘pen’
‘writes’	<i>n-tui</i>	+	<i>ma...-ʔ</i>	→	<i>ma-tuʔi</i>	‘written’
‘be aware’	<i>na-keo</i>	+	<i>ma...-ʔ</i>	→	<i>ma-keʔo</i>	‘aware’
‘believes’	<i>n-pirsai</i>	+	<i>ma...-ʔ</i>	→	<i>ma-pirsaʔi</i>	‘believing’
‘sings’	<i>n-sii</i>	+	<i>ʔ...-ʔ</i>	→	<i>ʔ-siʔi</i>	‘song’
‘wife’	<i>fee</i>	+	<i>ma...-ʔ</i>	→	<i>ma-feʔe</i>	‘having a wife’
‘leaf’	<i>noo-f</i>	+	<i>ma...-ʔ</i>	→	<i>ma-noʔo</i>	‘leafy’
‘base’	<i>uu-f</i>	+	<i>ma...-ʔ</i>	→	<i>ma-ʔuʔu</i>	‘based’

If words with a sequence of two identical vowels such as *fee* ‘wife’ were analysed as having a single long vowel, the insertion of a glottal stop in forms such as *ma-feʔe* ‘having a wife’ is completely unexpected; one segment should not be able to occur inside another. However, if such words have a sequence of two vowels, then this behaviour is simply explained by the second element of these prefixes occurring between the two vowel segments.

3 Phonology and phonotactics

A second reason for not analysing sequences of two identical vowels as phonemically long vowels is that under such an analysis every other vowel sequence (except for high vowels followed by mid vowels) would be attested with no apparent reason why sequences of two identical vowels do not occur.

While sequences of two identical vowels usually coalesce into a single phonetic syllable, each vowel is still treated as the nucleus of a separate syllable as regards to every phonological and morphophonemic process of the language. The only difference between sequences of two identical vowels and sequences of two different vowels is the frequency with which phonetic coalescence occurs: coalescence is almost universal for sequences of two identical vowels and only optional for sequences of two different vowels. Vowel coalescence is discussed further in §3.3.1

3.2.1.4.2 Kotos height dissimilation In Kotos Amarasi the second vowel of a sequence in which both vowels have the same height but different backness is often realised as /a/. This rule can apply to all sequences of two mid vowels, but only to sequences of two high vowels followed by a consonant. Examples are given in (15) below.

$$(15) \quad V \left[\begin{array}{c} \alpha_{\text{HIGH}} \\ \beta_{\text{BACK}} \end{array} \right] \rightarrow /a/ / V \left[\begin{array}{c} -\alpha_{\text{HIGH}} \\ -\beta_{\text{BACK}} \end{array} \right] -$$

General Amarasi			Kotos Amarasi		
<i>riuksaen</i>	[riʊk'saɛn]	▶▶	<i>riaksaen</i>	[riak'saɛn]	▶▶ 'python'
<i>seo</i>	['sɛɔ]	▶▶	<i>sea</i>	['sɛa]	▶▶ 'nine'
<i>oe</i>	['ʔɔɛ]	▶▶	<i>oa</i>	['ʔɔɐ]	▶▶ 'water'

This vowel dissimilation is perceived as distinctly peculiar to Kotos Amarasi and words such as *oa* 'water' are viewed by Kotos speakers, as well as outsiders, as emblematic of this variety. This height dissimilation does not occur in Ro'is Amarasi or Amabi.⁴

In some lexemes this rule also operates across an intervening glottal stop. The lexemes in my database in which this has been recorded are *kreʔo* → *kreʔa* 'a bit', and *seʔo* → *seʔa* 'ninth'.

3.2.1.4.3 Quantification of vowel sequence length The lengths of vowels and vowel sequences where one of the vowels of the sequence was eligible to bear

⁴Speakers of Kotos Amarasi report that this vowel dissimilation operates to different extents in different Kotos speaking villages and hamlets. Thus, for instances, inhabitants of the hamlet of Koro'oto have *oef-oaf* 'soup' while inhabitants of Fo'asa' are reported to only have *oef* 'soup'.

stress were measured in polysyllabic words from four texts of a single speaker. The vowels to be measured were marked in Praat with a TextGrid and the lengths extracted with a script. The measurements for vowels of words with a distinctive pause intonation, as well as pronouns, were excluded from the data set.

This yielded a total 1,249 measurements. Of these 472 tokens were of a single vowel, 314 represented a sequence of two identical vowels and 463 represented a sequence of two different vowels. The results are summarised in Table 3.4.

Table 3.4: Vowel lengths in Amarasi

	V	V _α V _α	V _α V _β	all
average length (sec.)	0.098	0.129	0.138	0.121
number of tokens	472	314	463	1,249
standard deviation	0.034	0.05	0.061	0.055
t-test (vs. V)		p <0.001	p <0.001	

This table shows that a sequence of two different vowels is on average 41% longer than a single vowel, while a sequence of two identical vowels is on average 31% longer than a single vowel. These differences are statistically significant as shown by a two tailed t-test.

A sequence of two identical vowels is distinct from a single vowel. However, it is not the case that every instance of a sequence of two identical vowels will always be phonetically longer than a single vowel. Other factors, such as sentence stress and intonation, can conspire to increase or decrease the phonetic length of any particular token of a vowel or vowel sequence.

Compare examples (16) and (17) below. In example (16) the vowel sequence of the word *fee* ‘wife’ measures 0.141 seconds; above the average for a sequence of two identical vowels. However, the same vowel sequence in the same word in sentence (17) measures 0.083 seconds; below the average for a single vowel.

- (16) [ʔɛsʔɛsə ʔ nək ʔɪn 'fɛ:0.141 ɪn mənɛ]
- es~esa =t n-ok iin fee iin mone*
- FRD~one =SUB 3-with 3SG wife 3SG man
- ‘each (of them) with their wife or their husband...’ 130928-1, 2.09 🔊
- (17) [wə nɛɛf ɪ fɛ0.083 mnasɪ ʔaɾɛ ɛnɛ'anɛ nɛβoʌn ɪ]
- ahh ʔnaef =am fee mnasiʔ areʔ anah~anah na-bua=n...*
- old.man =and wife old all FRD~child 3-gather=PL
- ‘the old men and woman, all the children gathered’ 130902-1, 3.52 🔊

3 Phonology and phonotactics

The word *fee* ‘wife’ is shortened in (17) as it is the first word of a modified noun phrase, and thus does not take primary stress (§3.3.4).

3.2.1.5 Loan vowel nativisation

The most common non-native vowel which occurs in loan words is the vowel /ə/. This vowel is reflected as /a/ in Amarasi as shown by Dutch *lezen* /le:zə/ > Amarasi *n-resa* ‘reads’. Instances of Malay /ə/ are also reflected as /a/, though in many cases these could be borrowings from Kupang Malay in which proto-Malay *ə usually became /a/. One example is *parikas* ‘to examine’ < Malay *periksa* /pərikʰsa/ or Kupang Malay *pariksa*.

3.2.2 Consonant inventory

Amarasi has thirteen phonemic consonants to draw on to fill a C-slot. These consonants are shown in Table 3.5. The symbols used in my phonemic transcription are given in Table 3.5a. These consonants are phonetically realised with the standard IPA values associated with the symbols given in Table 3.5b, with common allophones discussed below.

Table 3.5: Amarasi consonants

	(a) Broad transcription				(b) Narrow transcription					
	Labial	Coronal	Dorsal	Glottal	Labial	Dental	Alveolar	Palatal	Velar	Glottal
Plosives	<i>p</i>	<i>t</i>	<i>k</i>	<i>ʔ</i>	p	t̪			k	ʔ
Obstruents	<i>b</i>	<i>dʒ</i>	<i>gw</i>		b/β			dʒ/ʒ	gw/ɣw	
Fricatives	<i>f</i>	<i>s</i>		<i>h</i>	f		s			h
Nasals	<i>m</i>	<i>n</i>			m		n			
Liquid		<i>r</i>					r			

The liquid /r/ is realised as an alveolar trill [r], tap [ɾ], or occasionally as an alveolar approximant [ɹ]. In the speech of some speakers it is usually preceded by a voiceless component phrase initially, as shown in (18).

(18) /r/ → [hr] ~ [r] /#_

<i>ruman</i>	[hrɔmɛn]	🔊	‘empty’
<i>ruru-f</i>	[hrɔrɔf]	🔊	‘lips’
<i>reka?</i>	[hrɛkɛʔ]	🔊	‘when?’

No known Meto variety has a voiced alveolar plosive /d/ in native vocabulary. [d] only occurs in Amarasi epenthetically between /n/ and /r/. Likewise, epenthetic [b] often occurs between /m/ and /r/. Examples are given in (19).

(19) N[αPLACE] → N[αPLACE]P[αPLACE] /_r

<i>a/n-roo?</i>	[ʔa'ndrɔ:ʔ]	🔊	‘spews’
<i>a/n-reru?</i>	[ʔa'ndrɛrɔʔ]	🔊	‘is tired’
<i>?muik sumriri?</i>	[ʔmɔiksɯ'mbririʔ]	🔊	‘k.o. small lime’

The alveolar nasal /n/ assimilates to the place of a following obstruent in non-careful speech, with the exception of the labial plosives /p/ and /b/, before which such assimilation has not been observed in Amarasi.⁵ Examples are given in (20) below.

(20) /n/ → [αPLACE] /_P[αPLACE]

<i>a/n-tuup</i>	[ʔaŋ'tɔ:p]	🔊	‘sleeps’
<i>a/n-dʒair</i>	[ʔaŋ'dʒaer]	🔊	‘becomes’
<i>bankofa?</i>	[bɛŋkɔfɛʔ]	🔊	‘caterpillar’
<i>tungwuru</i>	[tɔŋ'gɔrɔ]	🔊	‘teacher’

The voiceless dorsal plosive /k/ is often palatalised before or after a front vowel. Two examples are given in (21) below.

(21) /k/ → [kʲ] /_V[+FR], V[+FR]#_

<i>uki</i>	[ʔɔkʲi]	🔊	‘banana’
<i>n-eik</i>	[nejkʲ]	🔊	‘takes’

The glottal stop /ʔ/ can be reduced to creaky voice on surrounding voiced segments. This is most common in rapid speech. Two examples from texts are given in (22) and (23) below.

(22) [ɛ:: ndrɛɔk hiʔɔ ŋkɔnɔ krɛʔ]
ehh n-reuk, hitu n-kono kreʔo
 3-pluck seven 3-pass little

‘a little bit after it struck seven o’clock.’

130920-1, 0.47 🔊

⁵Assimilation of /n/ to [m] or [ŋ] before labial obstruents occurs in other Meto varieties.

3 Phonology and phonotactics

- (23) [rɛ ɲsoŋɛ nɛʊ ɣbiɽɛn hrɔmɛ]
reʔ a|n-sounʔ=ee n-eu a-bi-t=an Roma
 REL 3-send=3SG.ACC 3-DAT NML-RL.LOC-NML=PL Roman
 ‘which [he] sent to the inhabitants of Rome.’ 130920-1, 0.27 🔊

The labio-dental fricative /f/ in Amarasi is usually articulated with the lower part of the lip touching the teeth, rather than with the top/outer part of the lip, as in English.

3.2.2.1 Voiced obstruents

The voiced obstruents /dʒ/ and /gw/ are marginal phonemes with a limited distribution. In native vocabulary they only occur as a result of vowel features spreading into empty C-slots, under the process of consonant insertion at clitic boundaries (§3.3.7.2, §5.3).

In Koro'oto the voiced velar obstruent /gw/ is not followed by a labio-velar glide before the back rounded vowels /u/ and /o/. Examples are given in (24).

- (24) /gw/ → [g] / _V[+ROUND]
- | | | | | | | |
|-----------------|---------|---|------------------------|---------------|---|-----------|
| <i>na-kneʔo</i> | + =oo-n | → | <i>na-kneeʔgw=oo-n</i> | [nak'ne:ʔgɔn] | 🔊 | ‘twisted’ |
| <i>na-tinu</i> | + =oo-n | → | <i>na-tiingw=oo-n</i> | [na'ti:ŋgɔn] | 🔊 | ‘worries’ |
| | | | <i>tungwuru</i> | [tʊŋ'gʊrʊ] | 🔊 | ‘teacher’ |

An alternate analysis of the same data would be to posit that this obstruent is underlyingly unrounded, and acquires rounding before unrounded vowels: /g/ → [gw] / _V[-ROUND]. However, such a rule is phonetically unmotivated, while the rule in (24) in which a rounded obstruent is de-rounded before rounded vowels is a phonetically natural rule of dissimilation. Despite the fact that it is non-distinctive, from now on I transcribe the unrounded allophone of /gw/ as <g> throughout this book.⁶

Apart from instances arising from consonant insertion, the voiced obstruents /dʒ/ and /gw/ also occur in loan words. Examples include *a|n-dʒair* ‘become’ ← Malay *jadi* and *tunguru* ‘teacher’ ← Malay *tuan* + *guru*. In some loans /dʒ/ is adapted as /r/ and /g/ as /k/ (§3.2.2.3).

The voiced obstruents are realised as stops [b dʒ gw], fricatives [β ʒ ɣw], or approximants [β j ɥw]. In many environments the alternation is a case of free

⁶In the variety of Kotos Amarasi spoken in the hamlet of Fo'asa' the voiced velar obstruent is never rounded, and for this variety of Amarasi I posit the phoneme /g/ rather than /gw/. Fo'asa' /g/ also occurs in a wider range of environments than Koro'oto /gw/. In Fo'asa' Kotos Amarasi /g/ is inserted at clitic boundaries after vowel-final stems. See §5.5.2 for more details.

variation, however, in certain environments either the stop or the continuant (fricative and approximant) allophones are more common. A count was made of the realisations of every voiced obstruent in three texts for my main consultant, Roni. The results are summarised in Table 3.6 below.



Table 3.6: Frequency of stop and continuant realisations[†]

		V_	N_	C_	#_
continuant:	[β ʒ ɣw]	61	0	23	5
stop:	[b dʒ gw]	23	12	9	7
stop %		27%	100%	28%	58%

[†] V_ is post-vocalic; both V_C and V_V, N_ is after a homorganic nasal and C_ is after other consonants

Table 3.6 shows that, for Roni, continuant allophones are dominant after vowels and consonants, while they do not occur after homorganic nasals. Only phrase initially are stop allophones slightly more common, though this could be an artefact of the tiny data sample in this environment.

Examples of both realisations of the bilabial obstruent /b/ taken from Roni's speech are given in (25)–(28) below. In (25) and (26) the bilabial obstruent /b/ is pronounced as a plosive [b]. In (25) the plosive occurs between two vowels and in (26) it occurs after a homorganic nasal.

- (25) [hɛj mɪbərəβ]
hai mi-barab
 1PX 1PX/2PL-prepare
 'We prepared,' 130902-1, 4.23 
- (26) [haj məkə mbi rɛ ɛæ: kosʊʔ]
hai m-oka m-bi re? ahh kosuʔ
 1PX 1PX/2-with 1PX/2-RL.LOC TOP dance.kind
 'We joined in with the *kosu*' dance.' 130902-1, 2.59 

Examples of the bilabial obstruent /b/ realised as a fricative [β] are given in (27) and (28) below. In (27) it occurs between two vowels and in (28) it occurs before another consonant. Example (28) also shows a both an affricate and fricative realisation of /dʒ/.

3 Phonology and phonotactics

- (27) [hɛ manse nmaɛβɛ t̥ɛ]
he? maans=ee n-maeb=ee =te
 hey sun=3DET 3-afternoon=3SG.ACC =SUB
 ‘hey, when it was the afternoon ...’ 130928-1, 1.41 🔊
- (28) [kɛstfɛ nraβʒɛ t̥ nak maso miŋta]
kaasɟ=ee n-raabɟ=ee =t n-ak: “maso minta”
 foreign=3DET 3-speak.foreign=3SG.ACC =SUB 3-QUOT enter ask
 ‘In a foreign language they call it ‘enter to ask’.’ 130902-1, 0.35 🔊

3.2.2.2 Consonant frequencies

A count of the frequency of each consonant was carried out on my current dictionary of 2,005 unique roots (including bound morphemes). This yielded a total of 5,063 consonants, the frequencies of which are given in Table 3.7 in order of frequency.

Table 3.7: Consonant frequencies

C	ʔ	n	k	t	s	r	b	m	p	f	h	ɟ	gw
no.	858	816	601	560	503	474	332	305	251	208	142	11	2
	17%	16%	12%	11%	10%	9%	7%	6%	5%	4%	3%	0.2%	0.04%

As can be seen from Table 3.7, the voiced obstruents /ɟ/ and /gw/ are extremely infrequent in my corpus. This provides additional evidence for their marginal status within the phoneme inventory. This table also shows that the glottal stop /ʔ/ is the most common consonant. This is despite the fact that it was not consistently transcribed in some earlier descriptions of Meto, notably those of Middelkoop.

3.2.2.3 Loan consonant naturalisation

The naturalisation of non-native consonants in Amarasi is summarised in Table 3.8. The phonemes /ɟ/ and /g/ in loanwords are usually adapted into Amarasi as /r/ or /k/ respectively, though in a small number of cases they undergo no change. Concerning the phoneme /ɟ/ (for which more examples are available), some words, such as ‘become’ shown in Table 3.8, have variants reflecting both /r/ and /ɟ/, while other words such as *baru* < Malay *baju* ‘shirt’ (ultimately from Persian) and *ɟeket* < Malay *jeket* < English *jacket* have only one form. That these

phonemes are often naturalised in Amarasi is additional evidence that they are marginal phonemes.

Table 3.8: Naturalisation of foreign consonants in Amarasi

	source	Amarasi	Donor	Meaning
/w/ → <i>b</i>	<i>kawin</i>	<i>kabin</i>	via Malay	‘wedding’
/ŋ/ → <i>n</i>	<i>sidang</i>	<i>siran</i>	via Malay	‘meeting’
/d/ → <i>r</i>	<i>duit</i>	<i>roit</i>	Dutch	‘money’
/l/ → <i>r</i>	<i>lezen</i>	<i>n-resa</i>	Dutch	‘read’
/dʒ/ → <i>r</i>	<i>jadi</i>	<i>n-rari</i>	via Malay	‘become’
/dʒ/ → <i>dʒ</i>	<i>jadi</i>	<i>n-dʒari</i>	via Malay	‘become’
/g/ → <i>k</i>	<i>igreja</i>	<i>krei</i>	Portuguese	‘church’
/g/ → <i>gw</i>	<i>tuan guru</i>	<i>tunguru</i>	via Malay	‘teacher’
/f/ → <i>s</i>	<i>percaya</i>	<i>n-pirsai</i>	via Malay	‘believe’

3.3 Prosodic structures

Three distinct units of Amarasi prosodic structure can be identified: the syllable (§3.3.1), a disyllabic foot (§3.3.2), and a prosodic word which is the locus of stress placement (§3.3.3).

3.3.1 The CVC syllable

The Amarasi syllable consists of an onset C-slot, a nucleus V-slot and a coda C-slot, thus $\sigma \rightarrow \text{CVC}$. Syllable weight plays no role in the languages. That is, Amarasi is not a quantity sensitive language.

C-slots which occur between two V-slots are ambisyllabic (Clements & Keyser 1983: 36, Durand 1990: 217ff). Such a C-slot is both the coda of the preceding syllable and the onset of the following syllable. Note the analysis of intervocalic consonants as ambisyllabic is a crucial part of my analysis of metathesis before vowel-initial syllables (§5.2). Independent evidence for this analysis comes from reduplication (§3.3.5).

This syllable structure is identical for all feet regardless of the contents of each of the C-slots and V-slots. Thus, each segmental vowel of a word is the nucleus of a unique syllable. The syllabification of *mu?it* ‘animal’, *fatu* ‘stone’, *kaut* ‘papaya’

3 Phonology and phonotactics

and *ai* ‘fire’ is shown in (29)–(32) below. Extensive evidence for empty C-slots is given in §3.3.7.

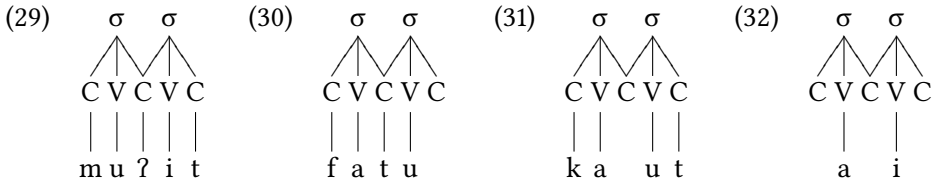

The only case in which the syllable structure is not CVC is in the derived CVVC M-foot and the initial syllable of vowel-initial enclitics, both of which are discussed in (§3.3.2).

Words with the surface structure (C)VVCV(C)#, such as *kauna?* ‘snake; creature’ are the only cases in which a sequence of two vowels is the nucleus of a single phonemic syllable. The first two vowels of such words are assigned to a single V-slot and thus by extrapolation form the nucleus of the syllable to which that V-slot belongs. This is discussed in more detail in §3.4.1.1 below. The syllabification of *kauna?* ‘snake; creature’ is shown in (33) below.

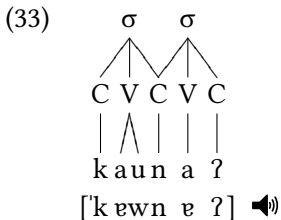

While each V-slot is phonemically the nucleus of its own syllable (with the exception of surface (C)VVCV(C) words), there are some situations in which a vowel sequence (§3.2.1.4) can optionally coalesce into a single phonetic syllable. This optional phonetic coalescence does not in any way affect the underlying phonemic structures. Two vowels which have coalesced into a single phonetic syllable remain the peak of two phonemic syllables for the purposes of stress assignment, reduplication, metathesis, and all other morphophonemic processes of the language.

Firstly, as discussed in §3.2.1.4.1, in normal speech a sequence of two identical vowels usually coalesces into a single phonetic syllable with a single intensity peak at the beginning of the vowel sequence. The examples from §3.2.1.4.1 are repeated in (34) below.

(34) $/V_\alpha V_\alpha/ \rightarrow [V:]$

<i>a/n-sii</i>	[ʔan'si:]	▶▶	'sings'
<i>fee</i>	[fɛ:]	▶▶	'wife'
<i>haa</i>	[ha:]	▶▶	'four'
<i>oo</i>	[ʔɔ:]	▶▶	'bamboo'
<i>tuu-f</i>	[tʊf]	▶▶	'knee'

Another situation in which two vowels often (though not always) are realised as a single phonetic syllable with only a single intensity peak at the beginning of the vowel sequence is when the second vowel is higher than the first. When this is the case the second vowel can be realised as an off-glide. Examples are given in (35) below.

(35) $/VV/ \rightarrow [V\bar{V}]$

<i>a/n-toup</i>	[ʔan'təwp]	▶▶	'receives'
<i>n-eik</i>	[nejk ⁱ]	▶▶	'takes'
<i>tei</i>	[tej]	▶▶	'faeces'
<i>fauk</i>	[fəwk]	▶▶	'how many'

This realisation is entirely optional, and many instances of a vowel followed by a higher vowel are realised transparently as two phonetic syllables. Examples are given in (36) below.

(36) $/VV/ \rightarrow [V.V]$

<i>tai-f</i>	[t̥a.if]	▶▶	'belly'
<i>snaen</i>	[sna.ɛn]	▶▶	'sand'
<i>ansao-f</i>	[ʔan'sa.ɔf]	▶▶	'solar plexus'
<i>tei</i>	[t̥e.i]	▶▶	'faeces'

Realisation as a single phonetic syllable rarely occurs when both vowels of a sequence are of equal height, or when the first vowel is higher than the second. Examples are given in (37) below.

(37) $/VV/ \rightarrow [V.V]$

<i>oe kmii</i>	[ʔɔ.ɛk'mi:]	▶▶	'urine'
<i>noah</i>	[nɔ.ɐh]	▶▶	'coconut'
<i>fua-f</i>	[f̥ʊ.ɐf]	▶▶	'fruit'
<i>ia</i>	[ʔi.a]	▶▶	'here'
<i>mneas</i>	[m̃nɛ.as]	▶▶	'hulled rice'

3 Phonology and phonotactics

Importantly for any analysis of metathesis in Amarasi, vowel sequences created through metathesis *do not* obligatorily coalesce. This means that an account of Amarasi metathesis in which metathesis is driven by the need for stressed syllables to be heavy (as has been proposed for Kwara'ae – see §2.3.1) cannot account for all the data.

Examples of vowel sequences created through metathesis in which phonetic coalescence has not occurred are given in (38) below. Additionally, in each example in (38) the second vowel is higher than the first; the kind of vowel sequence which most commonly coalesces.

(38) $V_1CV_2\# \rightarrow V_1V_2C\# \rightarrow [VVC]$

√ <i>toti</i>	<i>a n-toit</i>	[ʔaŋ't̪o.it̪]	◀▶	'asks'
√ <i>mani</i>	<i>a n-main</i>	[ʔan'ma.in]	◀▶	'laughs'
√ <i>hake</i>	<i>a n-haek</i>	[ʔan'ha.ɛkʰ]	◀▶	'stands'
√ <i>fanu</i>	<i>faun</i>	[fa.ʊn]	◀▶	'eight'
√ <i>tenu</i>	<i>teun</i>	[tɛ.ʊn]	◀▶	'three'

Coalescence of two vowels into a single phonetic syllable is more frequent in rapid speech and when the vowel sequence does not bear primary stress. Thus, in a particular wordlist, the word *hau* 'tree, wood' occurs in isolation as [ha.ʊ] ◀▶, without the second vowel being realised as an off-glide. However, in the same wordlist when the same word occurs in the compound *hau noʔo* 'tree leaf' it is realised as [haw'nɔʔɔ] ◀▶, with the second vowel desyllabified. Again, such desyllabification is *not* obligatory and vowel sequences which do not have primary stress also often surface with two phonetic syllables. One example is *oe mninuʔ* 'water (for) drinking' → [ʔɔ.em'ninʊʔ] ◀▶.

3.3.2 The CVCVC foot

One of the most important elements of word structure in Amarasi is the foot. All lexical words in Amarasi contain at least one foot. Amarasi has a syllabic foot structure in which a foot consists of two syllables. The structure of the Amarasi foot is given in (39) below.

(39) Ft → CVCVC

In (39) 'V' represents a V-slot which is obligatorily filled in by one of the segmental vowels (§3.2.1). The letter C represents a C-slot which is optionally filled by one of the segmental consonants (§3.2.2). Stress falls on the penultimate V-slot of the foot (§3.3.4).

Under my analysis, C-slots can be empty. This means that a word such as *mu?it* ‘animal’ has the same underlying structure as *fatu* ‘stone’, *kaut* ‘papaya’ or *ai* ‘fire’. In all cases these words map onto the same CVCVC foot structure. Thus, *fatu* ‘stone’, *kaut* ‘papaya’ and *ai* ‘fire’ have empty C-slots. The underlying structures of these three words are given in (41)–(43) below alongside *mu?it* ‘animal’ which has no empty C-slots.

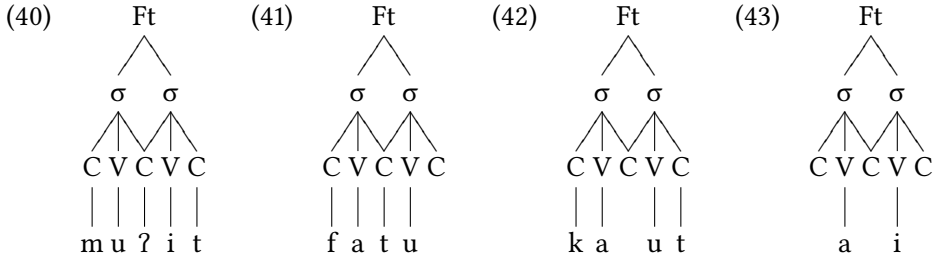

Under certain conditions there are phonetic traces of actual consonants in these empty C-slots. There are at least six morphological and/or phonological processes under which phonetic traces of these empty C-slots can be identified. These conditions are discussed in §3.3.7. In addition to these language-internal rules, in other varieties of Meto there are examples of actual consonants surfacing in environments for which I posit empty C-slots in Amarasi. This comparative data is also discussed in §3.3.7.

As discussed in complete detail in Chapter 4, metathesis in Amarasi targets the final CV sequence of a foot, usually with subsequent deletion of the final C-slot. This results in a derived foot structure with no medial C-slot. I will refer to this derived foot structure as the M-foot (Ft_M). The structures of the M-form of the words in (40)–(43) above; *mu?it* → *mui?* ‘animal’, *fatu* → *faut* ‘stone’, *kaut* → *kau* ‘papaya’, and *ai* → *ai* ‘fire’ are shown in (44)–(47) below.

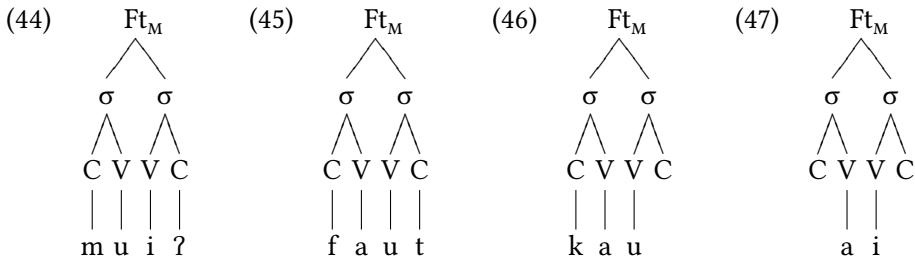

The only exceptions to this obligatory CVCVC foot are vowel-initial enclitics which have a defective onset-less VCVC foot. This structure is not problematic as

3 Phonology and phonotactics

such enclitics always occur attached to a host, the final C-slot of which supplies the onset C-slot for the enclitic. The structures of three vowel-initial enclitics metathesised and unmetathesised are given in (48) and (49) below to illustrate. These enclitics are =*esa*/=ees ‘one’, =*eni*/=ein ‘PL’ and =*ee* ‘3DET/3SG.ACC’.

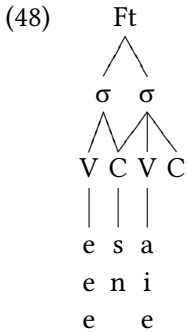

3.3.3 prosodic word

The prosodic word is the highest unit of Amarasi prosodic structure and is the domain within which stress is assigned. In most cases, stress is assigned to the penultimate syllable of the prosodic word.

The prosodic word in Amarasi is minimally composed of a disyllabic foot. In line with the principle of Foot Binarity (Prince 1980; McCarthy & Prince 1993b; Hayes 1994) any extra material is external to the foot and immediately dominated by the prosodic word. The structures of three words: *mu?it* ‘animal’, *mnasi?* ‘old, aged’, and *mahata?* ‘itchy’ are shown in (50)–(52) below.

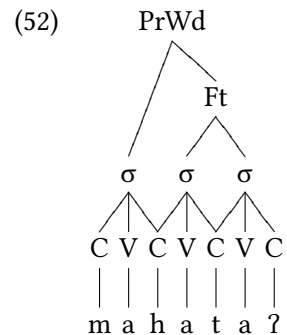
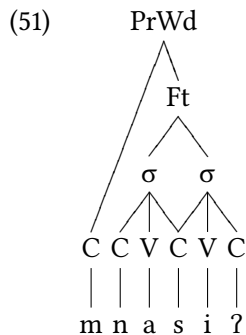
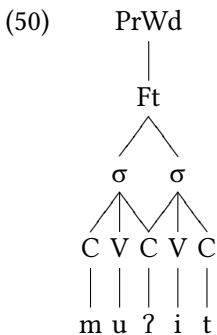

3.3.4 Stress

Stress in Amarasi falls on the penultimate syllable of the prosodic word. Usually this means the penultimate segmental vowel is stressed. The three main correlates of stress in Amarasi are duration, pitch, and intensity. A stressed vowel is typically realised with higher pitch, increased intensity, and is longer when compared to unstressed vowels.

A simple example can be seen in the word *nisi-f* → [nisɪf] 🗣️ ‘tooth’. The spectrogram for one repetition of this word in a wordlist is given in Figure 3.1. Intensity is shown by the solid yellow line and pitch by the dotted blue lines.

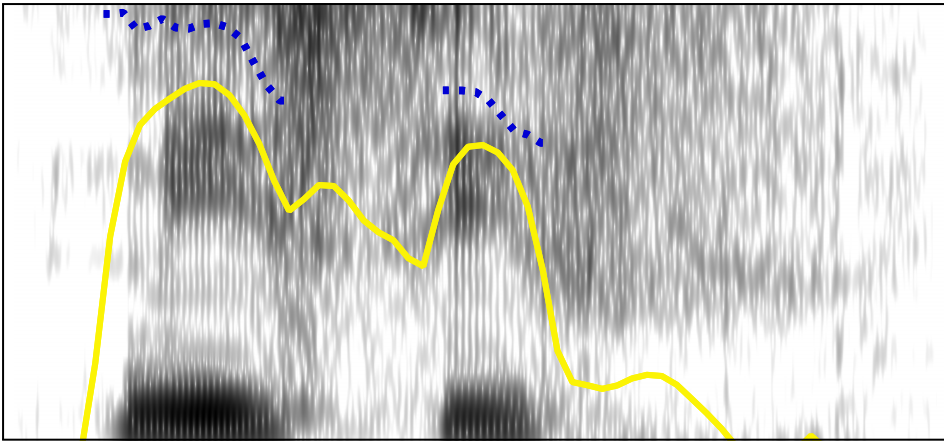

Figure 3.1: Spectrogram of [nisɪf] ‘tooth’

Table 3.9: Length, pitch, and intensity of vowels in [nisɪf] ‘tooth’

	V ₁	V ₂
length (sec)	0.095	0.07
peak intensity (dB)	80	75
peak pitch (Hz)	207	186

Visually, it is quite clear from Figure 3.1 that the initial vowel has higher pitch as well as increased intensity and duration when compared to the second vowel. The measurements for length, intensity, and duration for both vowels in this

3 Phonology and phonotactics

recording are given in Table 3.9. These figures can be considered broadly representative of the pattern observed for all feet.

Words with the surface structure VVCV(C)# are the only words in which the penultimate vowel is not stressed. The initial vowel sequence of such words is usually realised as a phonetic diphthong, with the higher vowel realised as an off-glide. The whole phonetic diphthong is then the locus of stress placement. Examples are given in (53) below. This otherwise irregular stress is analysed by positing that the first two vowels are assigned to a single V-slot (§3.3.1).

(53) (C)VVCV(C) → '(C)VVCV(C)

<i>kauna?</i>	[<i>'kəwne?</i>]	◀)	'snake; creature'
<i>aika?</i>	[<i>'ʔajka?</i>]	◀)	'thorn'
<i>nautus</i>	[<i>'nəwʔʊs</i>]	◀)	'beetle'
<i>naunu?</i>	[<i>'nəwʔʊ?</i>]	◀)	'breadfruit'
<i>uaba-ʔ</i>	[<i>'ʔwəbə?</i>]	◀)	'speech, language'

For words with more than two syllables, secondary stress is assigned to every second syllable to the left of the primary stress. This provides evidence that non-final feet form separate prosodic words. Two examples are *ataʔraʔe* 'praying mantis' → [*ʔaʔaʔraʔe*] ◀) and *aicʒonuus* 'kind of herb' [*ʔajʒʔʔnʊ:s*] ◀). The structures of each of these words are shown in (54) and (55) respectively. While each of these words contains two prosodic words, they are single morphemes, as indicated by the *M* on the bottom tier.

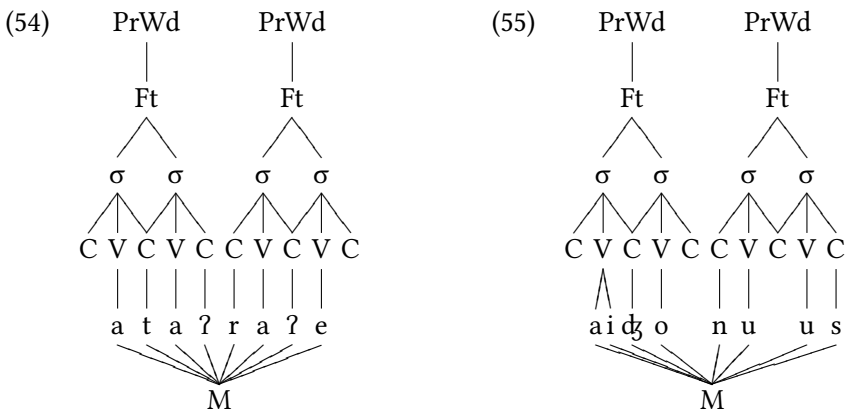

The penultimate vowel of the final nominal of the noun phrase bears primary stress with secondary stress being assigned to every second syllable to the left. Examples of noun phrases with this stress pattern are given in (56) below.

(56) Stress for nominal + nominal:

<i>aam baba?</i>	→	[,ʔam'babaʔ]	🔊	'father' + 'MB/FZ'
<i>ain baba?</i>	→	[,ʔæjn'babəʔ]	🔊	'mother' + 'MB/FZ'
<i>hau noʔo</i>	→	[,haw'nɔʔɔ]	🔊	'tree' + 'leaf'
<i>ʔnaak funu-f</i>	→	[,ʔnak'fɔnɔf]	🔊	'head' + 'hair'
<i>atoin munif</i>	→	[,ʔa,təjn'mɔnɪf]	🔊	'man' + 'young'
<i>oe mninu?</i>	→	[,ʔɔɛm'ninɔʔ]	🔊	'water' + 'drinkable'
<i>raan meto?</i>	→	[,hɾan'mɛtɔʔ]	🔊	'road' + 'dry'
<i>umi mnasi?</i>	→	[,ʔɔmim'nasiʔ]	🔊	'house' + 'old'
<i>mais_oni</i>	→	[,majɔʔoni]	🔊	'salt' + 'sugar' (='crystalline sugar')

There is no difference in the prosodic structure of a nominal phrase with multiple nominals compared with a single word greater than three syllables. The structures of *raan meto?* 'dry road' and *umi mnasi?* 'old house' are given in (57) and (58) respectively. In the case of *raan meto?* 'dry road' the first noun has undergone metathesis (from *ranan* 'road') and thus occurs with the derived CVVC M-foot (§3.3.2).

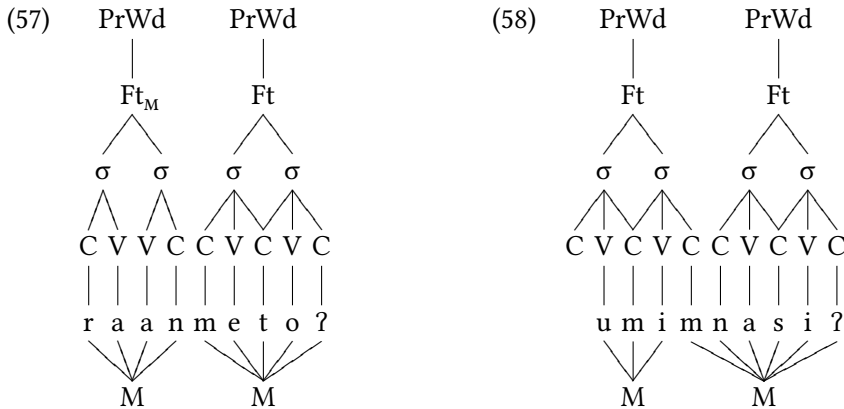

Enclitics are extra-metrical and do not count for stress. Primary stress is assigned to the penultimate syllable of the clitic host. Examples are given in (59).

(59) Stress for noun + enclitic:

<i>knaa?</i>	+	<i>=ee</i>	→	<i>knaaʔ=ee</i>	→	[ˈkna:ʔɛ]	🔊	'the bean'
<i>oo</i>	+	<i>=ee</i>	→	<i>oogw=ee</i>	→	[ˈʔɔ:gwɛ]	🔊	'the bamboo'
<i>oe</i>	+	<i>=ee</i>	→	<i>oodʒ=ee</i>	→	[ˈʔɔ:ɟɛ]	🔊	'the water'
<i>krei</i>	+	<i>=ee</i>	→	<i>kreedʒ=ee</i>	→	[ˈkre:ɟɛ]	🔊	'the church'

3 Phonology and phonotactics

The failure of clitics to bear stress is analysed as resulting from a recursive prosodic word structure in which clitics do not form independent prosodic words but are parsed together with the clitic host. Stress is then assigned to the most deeply embedded prosodic word.⁷ This is shown for *oo* + *=ee* → *oogw=ee* ‘the bamboo’ in (60) below. The clitic host takes the derived CVVC M-foot in (60) because metathesis before vowel-initial enclitics is obligatory.

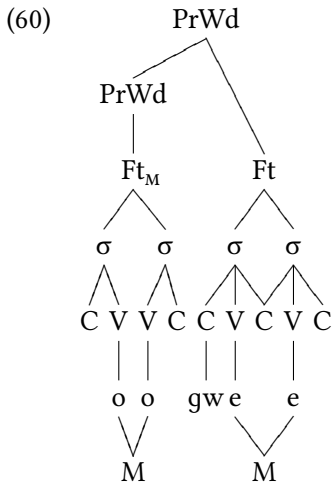

In a simple declarative sentence stress is usually assigned to the final prosodic word. Two examples are given in (61) and (62) below.

- (61) [haj mnaɣbnɛ t̚ ɔ: sɛɪ maʔfɛnɛʔ]
hai m-naebn=ee =t ro seor maʔfenaʔ.
hai m-naben=ee =te ro sero maʔfenaʔ
 1PX 1PX/2-feel=3SG.ACC =SUB real enough heavy
 ‘We felt (as though) it was really difficult enough.’ 130920-1, 1.10 🔊

- (62) [nɛ: haj mɾɛsɐ mɛkt̚ɔn̩t̚ɪjɲɛʔ]
na, hai m-resa m-mak-tun~tuinaʔ
 well 1PX 1PX/2-read 1PX/2-RECP-INTNS-follow
 ‘Well, we each read one after the other.’ 130920-1, 1.13 🔊

Sentence/phrasal enclitics (§3.7.3) are also extra-metrical and thus not usually counted for the purposes of stress assignment and stress usually falling on the final independent prosodic word of the phrase. Two examples of sentences with final enclitics are given in (63) and (64) below.

⁷Thanks goes to Daniel Kaufman for suggesting this analysis.

- (63) [haj ka mɾesa 'nɱɛːsɔ̃ɣɛh fa]
hai ka= m-resa n-meesɔ̃=aah =fa.
 hai ka= m-resa n-mese=ah =fa
 1PX NEG= 1PX/2-read 3-alone=just =NEG
 'We didn't read by ourselves. 130920-1, 1.23 🔊

- (64) [ndɿɛʊk 'fanʊ tɛː]
n-reuk fanu =te, ...
 n-reku fanu =te ...
 3-pluck eight =SUB
 'When it struck eight o'clock, ...' 130920-1, 0.51 🔊

The prosodic structure of (64) is given in (65), which shows that the clitic =te is parsed as a prosodic word with its host.

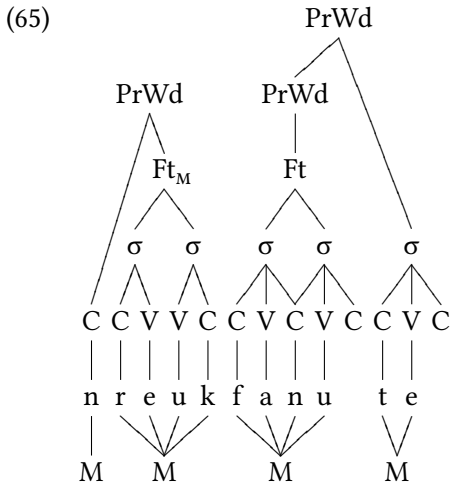

While the usual pattern is for sentence stress to fall on the (penultimate vowel of) the final word, other patterns can be found depending on the discourse structures within which the sentence is embedded. Two examples in which stress falls on a word other than the final word are given in (66) below which contains two clauses of a single “sentence”.

- (66) a. [haj ʔime 'mnaʊ miʔkə kuɛn]
hai ima m-naʊ mi-ʔko kuan,
 1PX 1PX/2PL\come 1PX/2-go 1PX/2PL-ABL village
 'We left the village, 130920-1, 0.40 🔊

3 Phonology and phonotactics

- b. [ʔɛ:s nɛɛn mɛsɛʔ kʰikʊ]
ees nean mese-ʔ kiku.
 COP day\M one-ORD early.morning
 it was (on) Monday morning.’



3.3.5 Reduplication

Reduplication provides support for the CVC syllable and CVCVC foot as distinct domains of Amarasi word structure. It also provides support for ambisyllabic intervocalic consonants as such consonants are copied in reduplication. Amarasi has two kinds of reduplication: full reduplication and partial reduplication. In full reduplication the entire word is copied. Examples include *reko* ‘good’ → *reko-reko* ‘properly’, and *nenō* ‘day’ → *nenō~nenō* ‘every day’.

In partial reduplication the initial syllable of the final foot is copied and prefixed to this final foot. That the reduplicant is CVC is evidence for identifying a CVC syllable with the intervocalic consonant as ambisyllabic. For roots which consist of a single foot, the reduplicant is simply placed to the left of the stem. Examples are given in (67) below.

(67) Partial reduplication:

<i>baʔuk</i>	→	<i>baʔ~baʔuk</i>	‘many’
<i>reko</i>	→	<i>rek~reko</i>	‘good’
<i>koʔu</i>	→	<i>koʔ~koʔu</i>	‘big’
<i>n-mate</i>	→	<i>n-mat~mate</i>	‘die’
<i>n-nao</i>	→	<i>n-na~nao</i>	‘go’
<i>n-tae</i>	→	<i>n-ta~tae</i>	‘look down’
<i>okeʔ</i>	→	<i>ok~okeʔ</i>	‘all’
<i>anaʔ</i>	→	<i>an~anaʔ</i>	‘small’

In the case of phonemically vowel-initial roots which begin with a predictable glottal stop (§3.3.6), this epenthetic glottal stop is the onset of both the reduplicant and following foot. Two examples are *ok~okeʔ* ‘all’ → [ʔɔkʔɔkeʔ]  and *an~anaʔ* ‘small’ → [ʔanʔaneʔ] .

When the medial C-slot of the foot is empty, the final C-slot of the reduplicant is filled by the final consonant of the foot. Examples are given in (68) below.

(68) Partial reduplication with empty medial C-slots:

<i>fauk</i>	→	<i>fak</i> ~ <i>fauk</i>	‘several’
<i>bua?</i>	→	<i>bu?</i> ~ <i>bua?</i>	‘together’
<i>na-tuin</i>	→	<i>na-</i> <i>tun</i> ~ <i>tuin</i>	‘follows; because of’
<i>kais</i>	→	<i>kas</i> ~ <i>kais</i>	‘don’t, PROHIBITIVE’
<i>na-ʔuab</i>	→	<i>na-</i> <i>ʔub</i> ~ <i>ʔuab</i>	‘speaks’

Suffixes or enclitics attached to a stem do not appear in the reduplicant in partial reduplication. Two examples include *n-poi=n* ‘3-exit=PL’ → *n-po~poi=n*, and *na-breo=n* ‘3-grope.around=PL’ → *na-bre~reo=n*.

There are two CCVVC# roots in my corpus in which the final consonant does not appear in the reduplicant: *ʔnaef* ‘old man’ → *ʔna~naef* and *mfaun* ‘many’ → *mfa~faun*. In both cases the final consonant is probably frozen morphology: the plural enclitic =*n* (§5.6) for *mfaun* ‘many’ and the genitive suffix *-f* (§A.3.1) for *ʔnaef* ‘old man’. Cognates of *ʔnaef* ‘old man’ include *na-ʔnae* ‘grow’ and the poetic word *ʔnaek* ‘great, big’.

Reduplication provides evidence for identifying the foot as a distinct unit of phonological structure as for roots which are larger than a single foot the CVC reduplicant is placed after the pre-foot material and prefixed to the foot, thus as a kind of infix. Examples are given in (69) below.

(69) Partial reduplication with pre-foot material:

<i>ʔroo</i>	→	<i>ʔro</i> ~ <i>roo</i>	‘far, distant’
<i>na-kbero?</i>	→	<i>na-kber</i> ~ <i>bero?</i>	‘move’
<i>na-msena</i>	→	<i>na-msen</i> ~ <i>sena</i>	‘full, satiated’
<i>na-thoe</i>	→	<i>na-tho</i> ~ <i>hoe</i>	‘inundate, bless’
<i>maʔfena?</i>	→	<i>maʔfen</i> ~ <i>fena?</i>	‘heavy’
<i>taikobi</i>	→	<i>taikob</i> ~ <i>kobi</i>	‘fall down’
<i>paumaka?</i>	→	<i>paumak</i> ~ <i>maka?</i>	‘near’

The prosodic and morphological structures of *maʔfena?* ‘heavy’ and its reduplicated counterpart *maʔfen~fena?* ‘very heavy’ are given in (70) below. Example (70b) shows the CVC reduplicant (*fen*) occurs as prefix to the final foot within the prosodic structure and thus as an infix within the morphological structure.

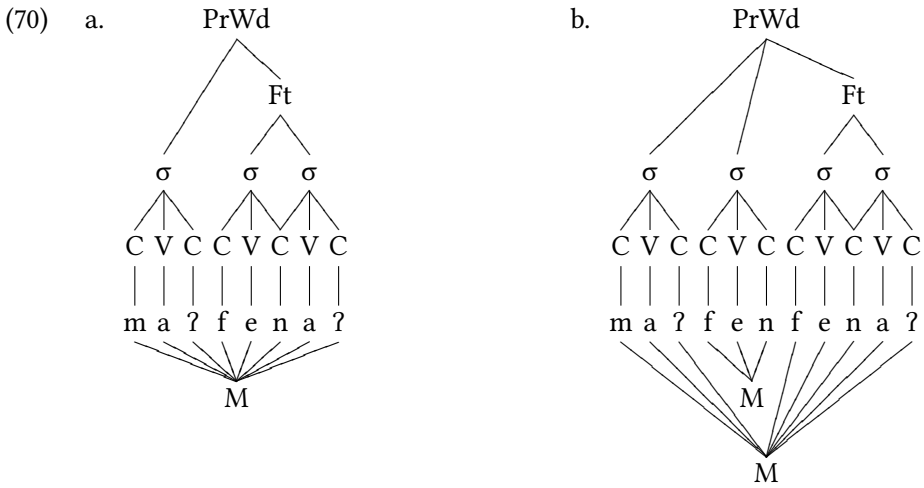

3.3.6 Glottal stop insertion

Amarasi has two processes of glottal stop insertion. One process occurs before vowel-initial stems after addition of an initial CV syllable. A second process occurs word initially before all vowels. In both cases the glottal stop is inserted to provide either the foot and/or the prosodic word with an onset consonant.

3.3.6.1 Glottal stop insertion foot initially

A glottal stop is inserted foot initially when a CV prefix attaches to a vowel-initial foot. This insertion can be analysed as occurring because feet in Amarasi require an onset consonant. A requirement for an onset is a common cross-linguistic constraint (McCarthy & Prince 1993b; Prince & Smolensky 1993/2002: 111f).

This process is clearly exemplified by roots which take consonantal agreement prefixes when intransitive and vocalic agreement prefixes when transitive (§A.1.1). Examples are given in Table 3.10, which shows several verb pairs which take the third person agreement prefix *n-* when intransitive and *na-* when transitive. With *na-*, a glottal stop occurs after the prefix.⁸

The prosodic and morphological structures of *n-ita* ‘see’ and *na-?ita-b* ‘show’ are given in (71) and (72) respectively. For *n-ita* ‘see’, the first C-slot of the foot is filled by the prefix *n-*. This foot thus has an onset consonant and no further processes are needed. However, for *na-?ita-b* ‘show’ the prefix is external to the foot and the first C-slot of this foot is thus filled by an epenthetic glottal stop.

⁸Transitive verbs also usually take either of the transitive suffixes *-ʔ* or *-b* (§A.3.2).

Table 3.10: Glottal stop insertion at morpheme boundaries

	Intransitive	Transitive	
‘enter, go into’	<i>n-tama</i>	<i>na-tama</i>	‘make enter, put inside’
‘go up, ascend’	<i>n-sae</i>	<i>na-sae-b</i>	‘put up, lift up’
‘push down’	<i>n-ʔai</i>	<i>na-ʔai-b</i>	‘push down’
‘rise, get up’	<i>n-fena</i>	<i>na-fena-ʔ</i>	‘raise, get s.o. up’
‘drink’	<i>n-inu</i>	<i>na-ʔinu-ʔ</i>	‘give a drink to s.o.’
‘see’	<i>n-ita</i>	<i>na-ʔita-b</i>	‘show, make see’
‘eat (hard food)’	<i>n-eku</i>	<i>na-ʔeku-ʔ</i>	‘feed’
‘run, flee’	<i>n-aena</i>	<i>na-ʔaena-b</i>	‘chase away, make run’
‘pick up’	<i>n-aiti</i>	<i>na-ʔaiti-ʔ</i>	‘pick up’

This glottal stop is not linked to any of the morphemes of this word, as befits its status as a non-meaningful epenthetic segment.

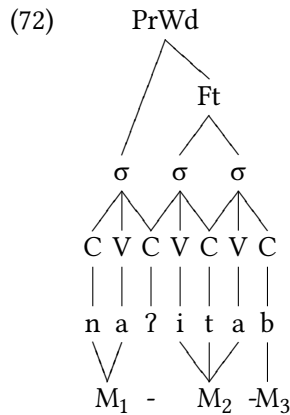
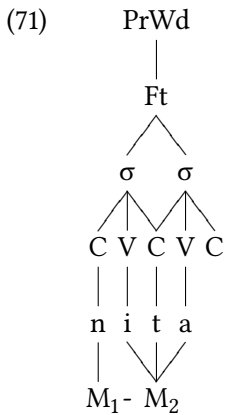

Such foot-initial glottal stop insertion is also seen with the reciprocal prefix *ma-* (§A.1.2) and when the property circumfix *ma-...-ʔ* attaches to a nominal stem (§A.2.2). An example with the reciprocal prefix is *ori-tata-ʔ* ‘siblings’ → *n-ma-ʔori-tata=n* ‘be siblings with one another’ and an example with the property circumfix is *umi* ‘house’ → *ma-ʔumi-ʔ* ‘having a house, housed’.

To summarise, attachment of a CV- prefix to a vowel-initial foot triggers glottal stop insertion as feet in Amarasi require an onset consonant. While it is obligatory for feet to have an onset, it is not obligatory for syllables to have an onset. However, the only syllable which occurs without an onset is the second syllable

3 Phonology and phonotactics

of a foot. This is seen in VV(C)# final words such as *kaut* ‘papaya’ which contain an empty medial C-slot, or M-forms such as *fatu* → *faut* in which case the M-foot contains no medial C-slot (§3.3.2).⁹

3.3.6.2 Word-initial glottal stop insertion

Word initially there is probably also a process of pre-vocalic glottal stop insertion, though the data for this is somewhat ambiguous. A more detailed, though earlier, discussion of the issues surrounding initial glottal stops is given in Edwards (2017). This second process of glottal stop insertion can be analysed as occurring to provide the prosodic word with an onset consonant.

The glottal stop is clearly a contrastive consonant. Near minimal pairs are given in Table 3.11 which shows the contrast between *ʔ*, *k*, *h*, and \emptyset medially, finally, and initially before another consonant.

Table 3.11: Contrasts between *ʔ* : *k* : *h* : \emptyset

V_V	Gloss	_#	Gloss	#_C	Gloss	
<i>ʔ</i>	<i>paʔe</i>	‘fortune’	<i>menuʔ</i>	‘bitter’	<i>ʔbibi</i>	‘goat’
<i>k</i>	<i>nake</i>	‘stocks’	<i>tenuk</i>	‘umbrella’	<i>kbiti</i>	‘scorpion’
\emptyset	<i>fae</i>	‘k.o. tree’	<i>tenu</i>	‘three’	<i>biki</i>	‘scar’
<i>h</i>	<i>nahe-n</i>	‘down’	<i>inuh</i>	‘beads’		

However, there are no phonetically vowel-initial words in Amarasi and there are no contrasts between the glottal stop and zero word initially. Both these facts are true of all words in all phrase positions. Three analyses of this data are logically possible:

- (73)
- All pre-vocalic initial glottal stops are distinctive.
 - All pre-vocalic initial glottal stops are automatic.
 - There is a difference between pre-vocalic initial distinctive and automatic glottal stops. (The difference emerges in certain environments.)

In his analysis of the Miomafo variety of Meto, Steinhauer (1993; 1996a) takes analysis (73a) and treats all pre-vocalic word-initial glottal stops as distinctive. In

⁹Thersia Tamelan (p.c. July 2018) reports that foot-initial glottal stop insertion is a distinctive feature of the speech of some Meto speakers who have acquired Dela, a language of Rote, as adults. Thus, for instance, Dela *na-oe* [na'œ] ‘watery’ is pronounced [na'ʔœ] with an erroneous medial glottal stop by some native speakers of Meto.

Edwards (2016a,b) I adopted analysis (73b) and posited that all pre-vocalic word-initial glottal stops were epenthetic. In Edwards (2017) I took analysis (73c) and provided evidence that some pre-vocalic initial glottal stops are distinctive and some are automatic. This is still the analysis I favour, though since the publication of Edwards (2017) I have collected additional data which indicates that Amarasi may be transitioning from a system in which some pre-vocalic initial glottal stops are automatic and some are distinctive (analysis 73c) to a system in which all are distinctive (analysis 73a).

What is not ambiguous, is that pre-vocalic glottal stops contrast with zero *root* initially. This contrast is revealed by the addition of prefixes consisting of a single consonant, such as the consonantal agreement prefixes (§A.1.1). Examples of pre-vocalic root-initial glottal stops and vowel-initial roots are given in (74) and (75) with the third person agreement prefix *n-*. The examples in (74) show that any initial glottal stop surfaces after the addition of this prefix.

(74) *n-* before glottal stop initial roots:

<i>n-</i> + √ <i>ʔator</i>	→	<i>n-ʔator</i>	[nʔaʔɔr]	▶▶	‘arrange’
<i>n-</i> + √ <i>ʔani</i>	→	<i>n-ʔain</i>	[nʔajn]	▶▶	‘head towards’
<i>n-</i> + √ <i>ʔoban</i>	→	<i>n-ʔoban</i>	[nʔɔbən]	▶▶	‘dig up (with snout)’
<i>n-</i> + √ <i>ʔonen</i>	→	<i>n-ʔonen</i>	[nʔɔnɛn]	▶▶	‘pray’
<i>n-</i> + √ <i>ʔere</i>	→	<i>n-ʔeer</i>	[nʔɛ:r]	▶▶	‘look intently’

(75) *n-* before vowel-initial roots:

<i>n-</i> + √ <i>akan</i>	→	<i>n-akan</i>	[nakən]	▶▶	‘grumble’
<i>n-</i> + √ <i>ani</i>	→	<i>n-ain</i>	[najn]	▶▶	‘before’
<i>n-</i> + √ <i>ono</i>	→	<i>n-oon</i>	[nɔ:n]	▶▶	‘harvest’
<i>n-</i> + √ <i>oʔen</i>	→	<i>n-oʔen</i>	[nɔʔɛn]	▶▶	‘call’
<i>n-</i> + √ <i>eku</i>	→	<i>n-euk</i>	[nɛʊk]	▶▶	‘eat’

However, with a single exception, none of the 35 unambiguously vowel-initial roots in my database have ever been attested without a prefix. This means that *word*-initial glottal stop insertion has never been observed with these roots.

The only exception is the root √*isa* ‘completely, totally, utterly; win’. This root has the inflected verbal form *n-isa* → *n-iis* [nɪ:s] ▶▶, showing that it is indeed vowel-initial, and the nominalised form *isa-t* [ʔɪsɛʔ] ▶▶ with an initial glottal stop analysable as an insertion. The nominalisation *isa-t* is identified by speakers as archaic and the form *m-n-isa-t* is more common in my data.

All other instances of pre-vocalic glottal stops in my database are either ambiguous, as the root has not yet been attested with mono-consonantal prefixes (112 examples), or the glottal stop can be shown to be distinctive (76 examples).

3 Phonology and phonotactics

Instances of distinctive pre-vocalic glottal stops include examples in which the initial glottal stop is almost certainly a historic insertion. Three examples are Proto-Malayo-Polynesian (PMP) *ama > *n-ʔama* → *n-ʔaam* [nʔa:m] ◀▶ ‘address as father’ (cf. *ama-f* [ʔaməf] ‘father’ ◀▶), PMP *anak > *n-ʔana* → *n-ʔaan* [nʔa:n] ◀▶ ‘address as child, produce a sapling’ (cf. *anah* [ʔanəh] ‘child’ ◀▶), and PMP *ina > *n-ʔaina* → *n-ʔain* [nʔain] ◀▶ ‘address as mother’ (cf. *aina-f* [ʔajnəf] ‘mother’ ◀▶).¹⁰

In addition to the form *isa-t* [ʔisət] ◀▶, there is one process which probably does provide evidence that word-initial glottal stop insertion before vowels remains productive in Amarasi. This is epenthesis of the vowel [a] before which glottal stop insertion also occurs.

Phrase initially, or after another consonant, epenthesis of [a] optionally occurs before a consonant cluster (see §3.5 for full details). This epenthetic [a] is usually, though not obligatorily, preceded by a glottal stop. Examples are given in Table 3.12 which contains the citation form of several consonant-initial verb roots from recorded wordlists. All verbs were cited with the third person agreement prefix *n-*, with [ʔa] before the initial consonant cluster.

Table 3.12: Glottal stop insertion before epenthetic [a]

Root	Citation	Phonetic		Gloss
√ <i>ɟari</i>	<i>a n-ɟair</i>	[ʔaɲɟaer]	◀▶	‘become’
√ <i>hake</i>	<i>a n-haek</i>	[ʔanʔhaekʔ]	◀▶	‘stand’
√ <i>kisu</i>	<i>a n-kius</i>	[ʔanʔkius]	◀▶	‘see’
√ <i>mani</i>	<i>a n-main</i>	[ʔanʔmain]	◀▶	‘laugh’
√ <i>reruʔ</i>	<i>a n-reruʔ</i>	[ʔanʔdɾerʊʔ]	◀▶	‘sleepy’
√ <i>roʔa</i>	<i>a n-rooʔ</i>	[ʔanʔdɾɔ:ʔ]	◀▶	‘spews’
√ <i>sii</i>	<i>a n-sii</i>	[ʔanʔsi:]	◀▶	‘sing’
√ <i>topu</i>	<i>a n-toup</i>	[ʔaɲtəwp]	◀▶	‘receive’
√ <i>toti</i>	<i>a n-toit</i>	[ʔaɲtəit]	◀▶	‘ask’
√ <i>tupa</i>	<i>a n-tuup</i>	[ʔaɲtʊ:p]	◀▶	‘sleep’

Given that vowel epenthesis is a predictable process, it would be extremely unusual for this epenthetic vowel to be accompanied by a distinctive, contrastive consonant. Instead, the glottal stop that precedes epenthetic [a] in Amarasi is best analysed as epenthetic.

¹⁰There is no evidence for identifying the initial glottal stop in such forms as a prefix.

The prosodic and morphological structure of *a|n-reru?* [ʔan'drerʊʔ] 'sleepy' is shown in (76). The initial glottal stop [ʔ] and vowel [a] are not linked to any morphemes, as befits their putative status as non-meaningful insertions.

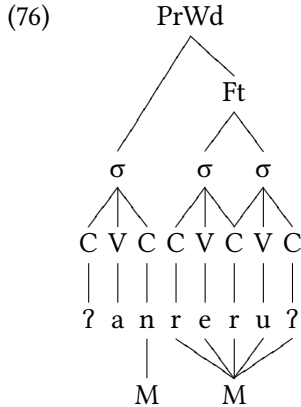

The presence of a glottal stop before epenthetic [a], indicates that word-initial pre-vocalic glottal stop insertion is still productive in Amarasi. This is consistent with glottal stop insertion foot initially, as discussed in §3.3.6.1 above.

However, the fact that nearly all (historic) word-initial insertions of glottal stop have been reanalysed as distinctive, combined with the productivity of the process in only one unambiguous environment and a single archaic form, indicates that Amarasi is transitioning from a system in which some initial pre-vocalic glottal stops are automatic and some are distinctive to a system in which all are distinctive.

On a practical level, I only transcribe root-initial pre-vocalic glottal stops when such roots take a prefix or when such a glottal stop is itself a prefix. This is consistent with the orthographic practices of native speakers of Amarasi.

3.3.7 Empty C-Slots

In §3.3.1 I proposed that the Amarasi syllable is CVC and in §3.3.2 that the foot is obligatorily CVCVC with empty C-slots permitted. In this section I provide evidence for these empty C-slots in Amarasi. Under certain conditions there are phonetic traces of actual consonants in these empty C-slots.

In this section I discuss seven situations in which consonants surface in positions we might not otherwise expect. The analysis I propose to account for this data is to posit an obligatory CVCVC foot in which C-slots can be empty. The

3 Phonology and phonotactics

seven phenomena are summarised in (77) below, along with the location of the empty C-slot within the root they provide evidence for.

- (77) Evidence for Empty C-slots in Amarasi:
- §3.3.7.1 Glottal stop infixation (medial)
 - §3.3.7.2 Consonant insertion at clitic boundaries (final)
 - §3.3.7.3 Vowel assimilation after consonant insertion (medial)
 - §3.3.7.4 Distribution of native /ɕʒ/ (medial)
 - §3.3.7.5 Glottal stop insertion (initial)
 - §3.3.7.6.1 Consonant insertion in other Meto varieties (medial/final)
 - §3.3.7.6.2 Non-etymological glottal stops (medial)

3.3.7.1 Glottal stop infixation

One piece of evidence for empty C-slots in Amarasi is the behaviour of the nominalising circumfix $?...-?$ (§A.2.3) and the property circumfix $ma...-?$ (§A.2.2). When these circumfixes attach to a surface CVCV root, the initial element occurs as a prefix and the second element as a suffix. Examples are given in (78).

- (78) Circumfixes $?...-?$ and $ma...-?$

‘grate’	\sqrt{fona}	+	$?...-?$	→	$?fona-?$	‘grater’
‘bind’	\sqrt{futu}	+	$?...-?$	→	$?futu-?$	‘cloth band’
‘sit’	\sqrt{toko}	+	$?...-?$	→	$?toko-?$	‘chair’
‘sweep’	\sqrt{sapu}	+	$?...-?$	→	$?sapu-?$	‘broom’
‘hear’	\sqrt{nena}	+	$ma...-?$	→	$ma-nena-?$	‘heard’
‘receive’	\sqrt{topu}	+	$ma...-?$	→	$ma-topu-?$	‘received’
‘stone, rock’	\sqrt{fatu}	+	$ma...-?$	→	$ma-fatu-?$	‘stony, rocky’
‘hair’	\sqrt{funu}	+	$ma...-?$	→	$ma-funu-?$	‘hairly’
‘key’	\sqrt{retu}	+	$ma...-?$	→	$ma-retu-?$	‘locked’
‘thorn’	\sqrt{aika}	+	$ma...-?$	→	$ma-?aika-?$	‘thorny’

When these circumfixes occur on a root with a final vowel sequence, the second glottal stop occurs between these two vowels as an infix. Examples are given in (79) to illustrate.

(79) Circum-/Infixes ʔ-...⟨ʔ⟩ and ma-...⟨ʔ⟩

‘cover’	$\sqrt{\text{neo}}$	+	ʔ-...-ʔ	\rightarrow	ʔ-ne⟨ʔ⟩o	‘umbrella’
‘pound’	$\sqrt{\text{pau}}$	+	ʔ-...-ʔ	\rightarrow	ʔ-pa⟨ʔ⟩u	‘mortar and pestle’
‘exit’	$\sqrt{\text{poi}}$	+	ʔ-...-ʔ	\rightarrow	ʔ-po⟨ʔ⟩i	‘exit (noun)’
‘sing’	$\sqrt{\text{sii}}$	+	ʔ-...-ʔ	\rightarrow	ʔ-si⟨ʔ⟩i	‘song’
‘write’	$\sqrt{\text{tui}}$	+	ʔ-...-ʔ	\rightarrow	ʔ-tu⟨ʔ⟩i	‘pen’
‘write’	$\sqrt{\text{tui}}$	+	ma-...-ʔ	\rightarrow	ma-tu⟨ʔ⟩i	‘written’
‘aware’	$\sqrt{\text{keo}}$	+	ma-...-ʔ	\rightarrow	ma-ke⟨ʔ⟩o	‘aware’
‘believe’	$\sqrt{\text{pirsai}}$	+	ma-...-ʔ	\rightarrow	ma-pirsa⟨ʔ⟩i	‘believing’
‘wife’	fee	+	ma-...-ʔ	\rightarrow	ma-fe⟨ʔ⟩e	‘having a wife’
‘leaf’	noo-f	+	ma-...-ʔ	\rightarrow	ma-no⟨ʔ⟩o	‘leafy’
‘base’	uu-f	+	ma-...-ʔ	\rightarrow	ma-ʔu⟨ʔ⟩u	‘based’

Under an analysis involving empty C-slots, the infixated allomorph can be captured by proposing that the circumfix is fundamentally a prefix with the second element occupying the first available empty C-slot from the left edge of the word.

When the medial C-slot of a root is already filled the first available empty C-slot is word final, as shown in (80) below for ʔ-toko-ʔ ‘chair’. When the root contains a vowel sequence the first available empty C-slot is root medial, as shown in (81) below for ʔ-si⟨ʔ⟩i ‘song’.

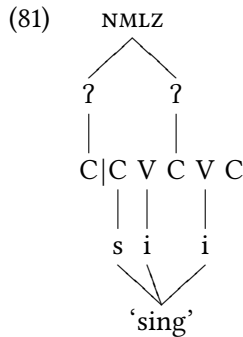
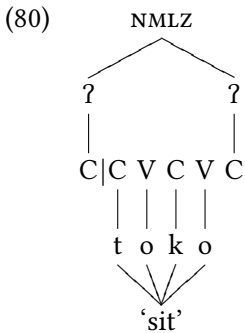

3.3.7.2 Consonant insertion

Amarasi has a process of consonant insertion which occurs before vowel-initial enclitics whereby the voiced obstruents /dʒ/ and /gw/ are inserted before vowel-initial enclitics as conditioned by the final vowel of the enclitic host. An overview of this process is given in §3.7.1, and it is analysed in full detail in Chapter 5.

This process can be analysed as resulting from vocalic features spreading into an adjacent empty C-slot. The first stage of the derivation of *fafi* ‘pig’ + *=ee* ‘3DET’

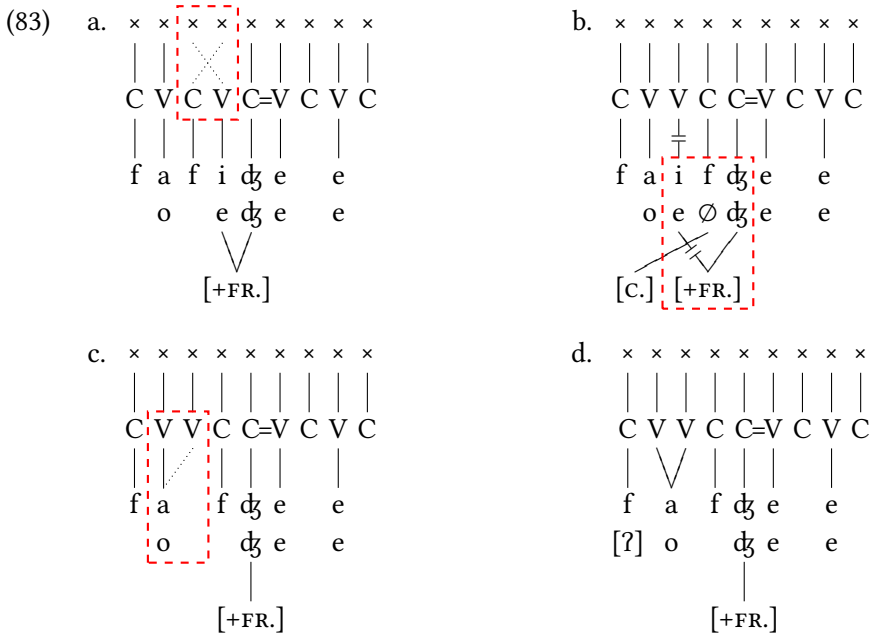

The de-linking of vocalic features in (83) for both *fafi* ‘pig’ and *oe* ‘water’ can be attributed to the presence of a medial C-slot. The only difference between these C-slots for *fafi* ‘pig’ and *oe* ‘water’ is that the latter has an empty medial C-slot.

3.3.7.4 /ɟ/ in native vocabulary

An additional piece of evidence for empty C-slots comes from the distribution of /ɟ/ in native Amarasi roots. There are currently five words in my dictionary of 1,913 unique lexical roots which are not obviously loans which contain /ɟ/. In each instance /ɟ/ occurs after a front vowel. These words are given in (84) below.

In addition to these five words the proximal demonstrative *ia* has the variant form *iɟa* (there are twelve attestations of *iɟa* in my corpus against 267 attestations of *ia*) and Ro’is Amarasi from Tunbaun has *poɟɟisa* ‘centipede’ (Buraen has *poɟɟisi*? and Kotos Amarasi has *?beebnisa*? for ‘centipede’).

(84) Attestations of native /ɟ/:

<i>aicɟoʔo</i>	[ʔajɟɔʔɔ]	🔊	‘casuarina tree’
<i>aicɟonuus</i>	[ʔajɟɔʔnɔ:s]	🔊	‘k.o. herb’
<i>biɟɟae</i>	[biʔɟɟae]	🔊	‘cow’
<i>naiɟɟeer</i>	[najʔɟɟe:r]	🔊	‘ginger’
<i>taiɟɟonif</i>	[tajʔɟɟonif]	🔊	‘jackfruit’

3 Phonology and phonotactics

Of these, the word *aidzonuus* ‘cummin’ is historically a compound of *aidzoʔo* ‘iron-wood tree’ and *nuus* which has no independent meaning in Amarasi. (In Fatule’u *nuus* is attested with the meaning ‘blue’.)

If the /ɟ/ were removed from the words in (84), we would find a sequence of three or more vowels in each instance. Given that sequences of more than two vowels are not found in Amarasi (§3.2.1.4), it is possible to analyse /ɟ/ in the examples in (84) as epenthetic, occurring to break up the disallowed underlying trivocalic sequence.

Under this analysis, the place features of the vowel /i/ would spread rightwards to fill an adjacent empty C-slot. The way in which this analysis would work is shown for *biɟae* in (85) below. In (85a) we have an illicit sequence of three vowels. The place feature [+FRONT] of the vowel /i/ spreads in (85b) to break up the VVV sequence, thus producing the consonant /ɟ/ in (85c).

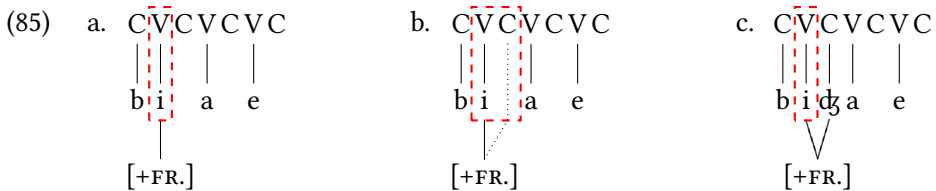

Evidence that this process has operated historically comes from cognates in other Meto varieties. Thus, Amanuban has *bia* or *bie* ‘cow’ and Kusa-Manea has *bea* or *bia* ‘cow’, all without medial /ɟ/.

While the /ɟ/ in the words in (84) is probably historically epenthetic, arising through a process similar to that illustrated in (85), in the modern language /ɟ/ also occurs in other environments in recent loanwords such as *ɟari* ‘to become’ < Malay *jadi* and *ɟeket* ‘jacket’ < Malay *jeket* < English *jacket*.

3.3.7.5 Glottal stop insertion

A fourth phenomenon which can be accounted for by empty C-slots is glottal stop insertion. This process is discussed in more detail in §3.3.6 on page 118. All phonemically vowel-initial words in Amarasi surface with a predictable glottal stop word initially. Examples are given in (86) below.

(86) /V/ → [ʔV] /#_

<i>ikaʔ</i>	[ʔikɐʔ]	☞	‘fish’
<i>ekam</i>	[ʔɛkɐm]	☞	‘wild pandanus’
<i>ate</i>	[ʔɐtɛ]	☞	‘servant’
<i>oo</i>	[ʔɔ:]	☞	‘bamboo’
<i>uki</i>	[ʔɔkʔi]	☞	‘banana’

Under an analysis involving empty C-slots, glottal stop insertion can be analysed as operating to obey a constraint requiring words to begin with a consonant. When the word contains no specified consonant, the consonant [ʔ] is inserted in the initial empty C-slot. This is shown for *uki* ‘banana’ in (87) below. In §5.3 I analyse the glottal stop /ʔ/ as the default word-initial consonant.

(87) a. # C V C V C b. # C V C V C c. # C V C V C

C	V	C	V	C		C	V	C	V	C		C	V	C	V	C
u	k	i				ʔ	u	k	i			ʔ	u	k	i	

3.3.7.6 Comparative support

There is also comparative support for empty C-slots in Amarasi. This comes from comparison with other varieties of Meto and Proto-Malyo-Polynesian (PMP) forms with their Meto reflexes. All reconstructions cited in this section are from (Blust & Trussel ongoing).

Firstly, there are a handful of words in which another variety of Meto has a full consonant where Amarasi has a medial empty C-slot. One example is the word for ‘two’, for which Amarasi *nua* (< *dua < PMP *duha) can be compared with Naitbelak Amfo’an *nuga* ‘two’ and Baikeno *nuban* ‘two’.¹¹ Both medial consonants can be analysed as resulting from features of the previous vowel spreading into an empty C-slot.

An additional Naitbelak Amfo’an example is *na-guab* ‘talks’, which can be compared with Amarasi *na-ʔuab* ‘speaks’. In this case both varieties have a root-initial consonant, which is probably originally epenthetic. Naitbelak Amfo’an has inserted a consonant conditioned by the following vowel and Amarasi has inserted default [ʔ]. (See §3.3.6 for more discussion of epenthetic [ʔ] in Amarasi.)

3.3.7.6.1 Word-final consonant insertion In addition to sporadic examples of medial C-slots which are empty in Amarasi but filled in other varieties of Meto,

¹¹The final *n* in Baikeno *nuban* could be a fossilised plural marker.

3 Phonology and phonotactics

there is also a regular system of word-final consonant insertion phrase finally in some varieties of Meto.¹² Such consonants are not historic retentions and can be predicted based on the quality of the final vowel. Phrase-final consonant insertion has been described and analysed for one variety of Meto, Nai'bais Amfo'an, by Culhane (2018).

In Nai'bais Amfo'an, consonant insertion affects all nouns which are final within the noun phrase (including the citation form), verbs which have an unspecified object, and pronominal possessors with an unspecified possessum (Culhane 2018: 31ff). Consonant insertion also occurs in Nai'bais Amfo'an before vowel-initial enclitics as it does in Amarasi (§3.3.7.2, §5.3).

In Amfo'an /g/ is inserted after the back vowels /o/ and /u/. Final /g/ is usually unreleased and slightly devoiced thus: [ŋ̚]. After the high front vowel /i/ the consonant /dʒ/ is inserted. Word-final /dʒ/ is usually devoiced, often de-palatalised and often tends towards a non-sibilant fricative.¹³ After /e/ the consonant /l/ is inserted. Examples are given in (88) below alongside their Amarasi cognates and Proto-Malayo-Polynesian (PMP) etyma.

(88) Amfo'an (Naitbelak) consonant insertion:

PMP	*taqi	*punti	*bahi	*wahiR	*qaləjaw	*asu	*batu
Amarasi	<i>tei</i>	<i>uki</i>	<i>fee</i>	<i>oe</i>	<i>nenog</i>	<i>asu</i>	<i>fatu</i>
Amfo'an	<i>teidʒ</i>	<i>ukidʒ</i>	<i>feel</i>	<i>oel</i>	<i>nenog</i>	<i>asug</i>	<i>fatug</i>
gloss	'faeces'	'banana'	'wife'	'water'	'day, sky'	'dog'	'stone'

In Baikeno, consonants are only inserted after vowel sequences: /b/ is inserted after /o/ and /u/, /dʒ/ is inserted after /i/ and /l/ is inserted after /e/. Baikeno /dʒ/ is almost always realised as a fricative [ʒ] or [z], likewise Baikeno /b/ is almost always the fricative [β]. Final /l/ in Baikeno is usually laminal [l̥] in recordings available to me. Examples of Baikeno consonant insertion are given in (89) below.

(89) Baikeno consonant insertion:

PMP	*hapuy	*taqi	*bahi	*wahiR	*qapuR	*kahiw	*qihu
Amarasi	<i>ai</i>	<i>tei</i>	<i>fee</i>	<i>oe</i>	<i>ao</i>	<i>hau</i>	<i>iik iu</i>
Baikeno	<i>aidʒ</i>	<i>teidʒ</i>	<i>feel</i>	<i>oel</i>	<i>aob</i>	<i>haub</i>	<i>iik iub</i>
gloss	'fire'	'faeces'	'wife'	'water'	'lime'	'wood'	'shark'

¹²See Figure 1.2 on page 6 for the locations of the varieties of Meto discussed in this section.

¹³All of the following phonetic symbols occur as transcriptions of inserted /dʒ/ in my own Naitbelak Amfo'an data: [dʒ], [ʃ], [tʃ], [ʒ] and [s]. Speakers identify this sound with the letter <j>, used in Indonesian for /dʒ/.

Fatule'u consonant insertion is very similar to that of Baikeno, though vowel assimilation occurs after insertion of /ɖʒ/. Additionally, there is one probable example of /l/ being inserted after /a/; PMP *quay > Fatule'u *ual* 'rattan'. Examples of Fatule'u consonant insertion are given in (90) below.

(90) Fatule'u (Bineon-Koa' hamlet) consonant insertion:

PMP	*hapuy	*waRi	*taqi	*bahi	*wahiR	*qapuR	*kahiw
Amarasi	<i>ai</i>	<i>fai</i>	<i>tei</i>	<i>fee</i>	<i>oe</i>	<i>ao</i>	<i>hau</i>
Fatule'u	<i>aaɖʒ</i>	<i>faaɖʒ</i>	<i>teeɖʒ</i>	<i>feel</i>	<i>oel</i>	<i>aob</i>	<i>haub</i>
gloss	'fire'	'night'	'faeces'	'wife'	'water'	'lime'	'wood'

In Kopas, consonant insertion takes place only after vowel sequences. Unlike Baikeno and Fatule'u (but like Amfo'an), /g/ is inserted after back vowels. After insertion of /ɖʒ/ or /g/ final vowels assimilate in Kopas. Inserted /g/ in Kopas is always voiced in my data, while inserted /ɖʒ/ is usually somewhat devoiced and tends towards a fricative. Examples of Kopas consonant insertion from Tuale'u hamlet are given in (91) below. Consonant insertion in Kopas as spoken in Usapisonba'i hamlet is almost identical, though [gw] is inserted rather than [g].¹⁴

(91) Kopas (Tuale'u hamlet) consonant insertion:

PMP	*hapuy	*taqi	*bahi	*wahiR	*qapuR	*kahiw	—
Amarasi	<i>ai</i>	<i>tei</i>	<i>fee</i>	<i>oe</i>	<i>ao</i>	<i>hau</i>	<i>kiu</i>
Kopas	<i>aaɖʒ</i>	<i>teeɖʒ</i>	<i>feel</i>	<i>oel</i>	<i>aag</i>	<i>haag</i>	<i>kiig</i>
gloss	'fire'	'faeces'	'wife'	'water'	'lime'	'wood'	'tamarind'

The most unusual kind of consonant insertion so far encountered occurs in Timaus, spoken on the border of the Amarasi area.¹⁵ Like Amfo'an, Timaus consonant insertion affects all vowel-final words, not just words which end in a vowel sequence. Timaus consonant insertion is also accompanied by a shift in the quality of the final vowel: root final /i/ is replaced by /ar/,¹⁶ final /o/ is replaced by /ugw/, final /u/ is replaced by /iɖʒ/, and /l/ is inserted after /e/ which then lowers to /a/.¹⁷ Examples are given in (92) below.

¹⁴Insertion of [gw] rather than [g] is viewed by inhabitants of Usapisonba'i as a distinguishing feature of their speech compared with the speech of inhabitants of Tuale'u.

¹⁵Timaus speakers trace their origins to *Timau* mountain in southern Amfo'an.

¹⁶Timaus /r/ is from original *ɖʒ which is inserted word finally in Amfo'an: e.g. Amarasi *fafi* = Amfo'an *faficɖʒ* = Timaus *fafar* 'pig'. Other instances of Amarasi /ɖʒ/ which correspond to Timaus /r/ include Amarasi *biɖʒae* Timaus *birael*, and Amarasi *naiɖʒeer* Timaus *nairael* 'ginger'.

¹⁷Lowering of /e/ to /a/ is a general feature of Timaus spoken in Sananu hamlet and affects all CV-final words, not just those which have undergone consonant insertion. One example is Amarasi *n-pake* = Timaus *n-paka* 'use' (both from Malay *pakai* [pake]).

3 Phonology and phonotactics

(92) Timaus (Sanenu hamlet) CV# consonant insertion:

PMP	*babuy	*talih	*Rumaq	—	*qaləjaw	*asu	*batu
Amarasi	<i>fafi</i>	<i>tani</i>	<i>ume</i>	<i>koro</i>	<i>nenō</i>	<i>asu</i>	<i>fatu</i>
Timaus	<i>fafar</i>	<i>tanar</i>	<i>umal</i>	<i>kolugw</i>	<i>nenugw</i>	<i>asidɟ</i>	<i>fatidɟ</i>
gloss	‘pig’	‘rope’	‘house’	‘bird’	‘day, sky’	‘dog’	‘stone’

When a noun ends in a vowel sequence in Timaus, the same consonants are inserted after a single vowel, with subsequent assimilation of the final vowel to the quality of the previous vowel. Vowel assimilation does not occur after insertion of /l/. Examples of Timaus consonant insertion after vowel sequences are given in (93) below.¹⁸

(93) Timaus (Sanenu hamlet) VV# consonant insertion:

PMP	*hapuy	*taqi	*bahi	*wahiR	*qapuR	*kahiw	—
Amarasi	<i>ai</i>	<i>tei</i>	<i>fee</i>	<i>oe</i>	<i>ao</i>	<i>hau</i>	<i>kiu</i>
Timaus	<i>aar</i>	<i>teer</i>	<i>feel</i>	<i>oel</i>	<i>aagw</i>	<i>haaɟ</i>	<i>kiidɟ</i>
gloss	‘fire’	‘faeces’	‘wife’	‘water’	‘lime’	‘wood’	‘tamarind’

Word-final consonant insertion in other varieties of Meto provides evidence for positing final empty C-slots in Amarasi. That consonant insertion is most common after vowel sequences may be due to Meto varieties dis-prefering more than one empty C-slot per foot.

3.3.7.6.2 Non-etymological glottal stops Some words in Amarasi occur with a medial glottal stop which is not expected by regular sound changes. Cognates of these words in Amanuban occur with a word-final glottal stop. The Amarasi words which are clear inheritances from Proto-Malayo-Polynesian (PMP) in which this non-etymological glottal stop occurs are given in (94) below, along with Amanuban cognates for comparison.

(94) Non-etymological glottal stops in Amarasi and Amanuban:

PMP	*baqəRu	*dahun	*ma-iRaq	*kakay	*puqun
Amanuban	<i>feuʔ</i>	<i>nooʔ</i>	<i>meeʔ</i>	<i>haeʔ</i>	<i>uuʔ</i>
Amarasi	<i>feʔu</i>	<i>noʔo</i>	<i>meʔe</i>	<i>haʔe</i>	<i>uʔu</i>
gloss	‘new’	‘leaf’	‘red’	‘leg’	‘source’

¹⁸The insertion of /ɟ/ after /u/ in Timaus may be explicable in terms of a push-pull chain. Word-final front vowels /i/ and /e/ condition insertion of /r/ and /l/ respectively after which these vowels lower to /a/. Word-final /o/ conditions insertion of /gw/ after which /o/ is then raised to /u/. Word-final /u/ is either pushed or pulled into the empty high front vowel position, and then conditions insertion of /ɟ/.

Although the forms in (94) are reconstructed with medial consonants, each of PMP *q, *R, *h, and *k are otherwise regularly lost word medially in Meto. An example of each with an Amarasi reflex includes *ma-qitəm > *metan* ‘black’, *diRus > *na-niu* ‘bathe’, *duha > *nua* ‘two’, and *sakay > *n-sae* ‘go up’. Many more examples can be found in Edwards (2016b).

Additionally, when a genitive suffix is attached to the Amarasi words in (94), the medial glottal stop does not appear. Examples are given in (95) below. A complete list of the forms (including those not inherited from PMP) in which a medial glottal stop is deleted after genitive suffixation is given in §A.3.1 on page 449.

(95) Medial glottal stop deletion:

<i>feʔu</i>	+	-f	→	<i>moen feu-f</i>	‘son-in-law’ (lit. ‘new male’)
<i>noʔo</i>	+	-f	→	<i>noo-f</i>	‘leaf’
<i>haʔe</i>	+	-f	→	<i>hae-f</i>	‘leg’
<i>uʔu</i>	+	-f	→	<i>uu-f</i>	‘tree trunk, source’

In addition to the words given in (94), the PMP inheritances *taqi > *tei* ‘faeces’ and *kəmiq > *kmii* ‘urine’ have verbal forms with an unexpected medial glottal stop: *na-teʔi* ‘defecates’ and *na-kmiʔi* ‘urinates’.

Historically these glottal stops are usually a result of a historic suffix metathesising with the final vowel. This suffix is attested in the Rote languages, as seen in for instance in Termanu *beu-k*, Dengka *feu-ʔ* ‘new’, Termanu *doo-k*, Dengka *loo-ʔ* ‘leaf’, and Termanu *huu-k*, Dengka *huu-ʔ* ‘tree trunk, source’.

Synchronically, the presence of medial non-etymological glottal stops in some forms of certain roots is evidence for medial empty C-slots between other vowel sequences.

3.3.7.7 Summary

In this section I discussed five language-internal phenomena and three comparative phenomena which provide evidence for empty C-slots in Amarasi. Amarasi is not an isolated example of a language with empty C-slots. Other languages analysed with empty C-slots include Turkish and Finnish (Clements & Keyser 1983), Seri (Marlett & Stemberger 1983), and Irish (Anderson 2016).

One way in which the empty C-slots in Amarasi differ from those of Turkish, Finnish, and Seri is that in each of these languages there is only a sub-set of words with empty C-slots, with these words behaving exceptionally due to the loss of a historic consonant.

3 Phonology and phonotactics

However, empty C-slots in Amarasi are different in several respects. Firstly, empty C-slots are not restricted to a lexically specified sub-set of words, but are found in any word whose final foot does not surface as CVCVC. Secondly, empty C-slots in Amarasi have not arisen from the loss of a historic consonant. To take just two examples, the word *asu* ‘dog’ with an empty initial C-slot and empty final C-slot is a reflex of proto-Austronesian **asu* without any consonants in these positions. Likewise, Amarasi *fua-f* ‘fruit’, with an empty medial C-slot, is a reflex of proto-Austronesian **buaq* without any medial consonant (Blust & Trussel ongoing). Instead, empty C-slots in Amarasi have arisen from the highly constrained CVCVC foot structure of the language.

It is worth considering what it means at a philosophical level to say that Amarasi has empty C-slots. Obviously, native speakers cannot hear these empty segments. Are they then merely a notational convenience for the analyst? While this clearly *is* part of the reason for positing empty C-slots, I do not think it is the only reason. By positing empty C-slots I am fundamentally saying that in the grammar of Amarasi a word such as *ai* ‘fire’ is treated the same way as a word such as *mu?it* ‘animal’, despite their surface phonotactic differences.

Finally, do these empty C-slots have psychological reality for speakers? The comparative data from other varieties in which consonants occur where I posit empty C-slots indicates that they may indeed have some level of psychological reality for at least some speakers. Furthermore, discussions with speakers of Amarasi who have extensive exposure to varieties such as Amfo’an, with its regular insertion of word-final consonants, show that these Amarasi speakers are aware of a rule of the kind: “All Amarasi words which are vowel final end in a consonant in Amfo’an.” This is, perhaps, the way in which empty C-slots are present to Amarasi speakers. They exist in the social dynamics of interactions between speakers of different varieties of what is conceptualised as a single language.

3.4 Root structure

Amarasi roots have a highly constrained phonotactic structure. Lexical roots are minimally composed of the CVCVC foot (§3.3.2). However, functors are not necessarily composed of a foot, with 28 out of 64 functors in my corpus currently analysed as monosyllabic.

A lexical root in Amarasi is minimally composed of the CVCVC foot. This foot can optionally be preceded by another foot, a CVC syllable or a single consonant. This root structure is given in (96) below.

$$(96) \text{ Lexical Root} \rightarrow \left. \begin{array}{c} \emptyset \\ C \\ \sigma \\ Ft \end{array} \right\} Ft$$

In my current corpus, 64% (1,223/1,913) of lexical roots are a single foot, 21% (401) consist of a single foot preceded by an additional consonant, 9% (178) consist of a foot preceded by a syllable, and 6% (106) consist of two feet. Five words have an exceptional structure.

3.4.1 Roots with one foot (root \rightarrow Ft)

Roots consisting of a single foot are the most common kind of root in my corpus with 64% (1,223/1,913) of all lexical roots containing a single foot.¹⁹

Given that C-slots may be empty in Amarasi (§3.3.7), a root with a single foot may surface maximally as CVCVC, with all C-slots filled, and minimally as VV, with all C-slots empty. Word-initial empty C-slots are automatically filled by a phonetic glottal stop (§3.3.6). An example of every attested structure for words with a single foot is given in Table 3.13.

Table 3.13: Roots with a single foot

Structure	Root	Phonetic		gloss	no.	%
CVCV	<i>fatu</i>	[ʼfaʔʊ]	◀▶	‘stone, rock’	547	45%
CVCVC	<i>manas</i>	[ʼmanəs]	◀▶	‘sun’	345	28%
CV V	<i>hau</i>	[ʼhau]	◀▶	‘wood, tree’	133	11%
CV VC	<i>puah</i>	[ʼpʊəh]	◀▶	‘betel nut’	77	6%
V CV	<i>asu</i>	[ʼʔasʊ]	◀▶	‘dog’	54	4%
VCVC	<i>anin</i>	[ʼʔanin]	◀▶	‘wind’	51	4%
V V	<i>ai</i>	[ʼʔai]	◀▶	‘fire’	10	1%
V VC	<i>uat</i>	[ʼʔʊəʔ]	◀▶	‘veins’	6	

3.4.1.1 Surface VVCV(C)# words

Among disyllables, there are also 32 words with the structure VVCV(C)# in my dictionary. I analyse such words as consisting of a single foot. All Amarasi words

¹⁹There is only one root in my entire corpus which has two syllables and a non-CVCVC foot. This is the loan *maski* ‘even though’ from Portuguese *mas que*.



3 Phonology and phonotactics

so far attested with this shape have identical final and penultimate vowels, or the final vowel is /a/. These words are all given in 3.14 below.

Table 3.14: Amarasi surface VVCV(C)# words

Amarasi	Gloss	VV	Amarasi	Gloss	VV
<i>aika?</i>	‘thorn’	<i>ai</i>	<i>n-auban</i>	‘crowd’	<i>au</i>
<i>n-aikas</i>	‘praise’	<i>ai</i>	<i>aunu</i>	‘spear’	<i>au</i>
<i>aina-f</i>	‘mother’	<i>ai</i>	<i>kauna?</i>	‘snake; creature’	<i>au</i>
<i>n-aini</i>	‘mourn’	<i>ai</i>	<i>n-?aubar</i>	‘unify’	<i>au</i>
<i>n-aiti</i>	‘pick up’	<i>ai</i>	<i>na-?kaunu?</i>	‘bother’	<i>au</i>
<i>baiti?</i>	‘should’	<i>ai</i>	<i>mauku?</i>	‘cuscus’	<i>au</i>
<i>na-kaina?</i>	‘forbid’	<i>ai</i>	<i>na-maunu</i>	‘crazy’	<i>au</i>
<i>na-?aisa</i>	‘tie’	<i>ai</i>	<i>na-mausa-b</i>	‘domesticate’	<i>au</i>
<i>na-maika?</i>	‘remain’	<i>ai</i>	<i>mautu</i>	‘allow’	<i>au</i>
<i>na-saitan</i>	‘leave’	<i>ai</i>	<i>naunu?</i>	‘breadfruit’	<i>au</i>
<i>n-aena</i>	‘run’	<i>ae</i>	<i>nautus</i>	‘beetle’	<i>au</i>
<i>n-aesa</i>	‘squeeze’	<i>ae</i>	<i>na-noeba?</i>	‘listless’	<i>oe</i>
<i>na-?aeka?</i>	‘soak’	<i>ae</i>	<i>na-roitan</i>	‘prepare’	<i>oi</i>
<i>na-taeka?</i>	‘puddle’	<i>ae</i>	<i>na-soitan</i>	‘open’	<i>oi</i>
<i>n-eiti</i>	‘travel’	<i>ei</i>	<i>uaba?</i>	‘speech’	<i>ua</i>
<i>n-meiti</i>	‘dry up’	<i>ei</i>	<i>na-kaaka</i>	‘howl’	<i>aa</i>

Under this analysis the first two vowel segments of such words are assigned to a single V-slot, thus forming a kind of phonetic diphthong. The proposed structures of *kauna?* → [kəwnə?] ◀ ‘snake; creature’, *aika?* → [ʔajka?] ◀ ‘thorn’ and *aina-f* → [ʔajnef] ◀ ‘mother’ are given in (97) below.

- (97) a. 
- b. 
- c. 

There are four observations which support this analysis. Firstly, as discussed in §3.3.4 (page 112), stress falls on the penultimate segmental vowel of a word in

Amarasi. For VVCV(C)# words, however, stress falls on the antepenultimate segmental vowel. This otherwise aberrant stress pattern can be explained by positing that stress is assigned to the penultimate V-slot of the foot, rather than being assigned to any specific segmental vowel.

Secondly, in almost all cases the initial vowel sequence of a VVCV(C)# word forms a phonetic diphthong and the second vowel is realised as a glide, as illustrated with the three examples in (97) above.

The only word for which I am aware that a phonetic diphthong is not always found is *uaba?* ‘speech, to speak’. There are seven instances of the U-form of this word in my corpus (with a verbal agreement prefix in six instances). Five have a phonetic diphthong [ʔwəbɛʔ] and two cases have two full vowels [ʔʊ.ɐbɛʔ]. An example of the latter pronunciation is given in (98) below. However, even in such instances stress falls on the antepenultimate segmental vowel.

- (98) [ʔan'pæŋk sɪn ʔʊ.ɐbɛʔ]
a/n-pæŋk siin uaba?
 3-use 3PL speech
 ‘... using their language’ 130920-1, 4.18 🔊

Thirdly, when we examine *which* vowel sequences occupy the initial V-slot in such words, we find a preference for the VV sequence to be /au/ (11/32) or /ai/ (10/32), with 21/32 words having either of these sequences; 66%. Such sequences represent the most common kinds of diphthongs in languages of the world (Lindblom 1986: 36, Miret 1998: 40).

Fourthly, if surface VVCV(C)# words did in fact consist of a syllable and a foot, they would be the only words whose final foot was not preceded by a consonant, either a phonemic consonant (§3.2.2) or a predictable glottal stop (§3.3.6). For these reasons I analyse the initial vowel sequence in surface VVCV(C)# as being assigned to a single V-slot.

3.4.1.2 Ro'is Amarasi diphthongisation

In Ro'is Amarasi there is a regular process whereby the penultimate vowel of a word becomes a diphthong by copying the final vowel into the penultimate V-slot after the underlying penultimate vowel.²⁰ This only operates for CVC# final words. Examples are given in Table 3.15 alongside cognates in Kotos for

²⁰The same process of diphthongisation described in this section also occurs in the variety of Meto spoken in the village of Oepaha immediately to the east of the Ro'is area.

3 Phonology and phonotactics

comparison. I transcribe diphthongs formed by this automatic process with the tie-bar [˘] to distinguish them from underlying vowel sequences.

Table 3.15: Ro'is Amarasi stressed diphthongisation

Kotos	Ro'is	gloss	Kotos	Ro'is	gloss
<i>tefis</i>	<i>tēɪfik</i>	'roof'	<i>niis eno-f</i>	<i>niis ēono-f</i>	'incisors'
<i>masik</i>	<i>mā̄sik</i>	'salt'	<i>n-ʔator</i>	<i>n-ʔā̄otor</i>	'arrange'
<i>toʔis</i>	<i>tōiʔis</i>	'trumpet'	<i>siʔu-f</i>	<i>sī̄uʔu-f</i>	'elbow'
<i>hunik</i>	<i>hū̄inik</i>	'turmeric'	<i>esuk</i>	<i>ēusuk</i>	'mortar'
<i>anet</i>	<i>ā̄enet</i>	'needle'	<i>manus</i>	<i>mā̄unus</i>	'beetle vine'
<i>rone-f</i>	<i>rō̄ene-f</i>	'brain'	<i>ponu-f</i>	<i>pō̄unu-f</i>	'body hair' [†]

[†] Kotos *ponu-f* is 'moustache' and Ro'is *pō̄unu-f* is 'body hair'.

In my Ro'is data this process does not affect words in which the penultimate and final vowels are the same, words in which the final vowel is /a/, or words the final consonant of which is /ʔ/.²¹

This process is highly productive and applies to loans (e.g. Malay *ator* → *n-ʔā̄otor* 'arrange'), words whose final consonant is a suffix (e.g. *eno?* 'door' → *niis ēono-f* 'incisors' lit. 'door teeth') and even across clitic and word boundaries so long as the consonant of the following morpheme is the coda of the morpheme which undergoes diphthongisation. Examples of Ro'is diphthongisation operating across morpheme boundaries are given in (99)–(101) below. In (99) the consonant triggering diphthongisation is an enclitic, in (100) it is the prefix of the following word and in (101) it is the first member of root-initial cluster.

- (99) *ɕʒadi n-tean-a? toon boa? hī̄utu =m niim =te, nai? au ku-snaas*
ɕʒadi n-tean-a? toon boa? hitu =ma niim =te nai? au ku-snasa
 so 3-until-TR year ten seven =and five =SUB then 1SG 1SG-stop
 'so (I did it) up until the year 1975, then I stopped' R0-170830-1, 4.26 🗣️
- (100) *nunati? hiin n-paakɕ=ee, n-fā̄ini n-biʔaak he? hiin moin-n=ii,*
nunati? hini n-pake=ee n-fani n-biʔaka he? hini moni-n=ii
 IRR 3SG 3-use=3SG.ACC 3-again 3-RL.LOC TOP 3SG life-3SG.GEN=1DET
 'so that he can use it again in his life' R0-170829-1, 19.03 🗣️

²¹There is evidence that this process operates for some words with final /a/ in some other varieties of Ro'is Amarasi. Thus, I collected the words *pō̄aʔan* ← *poʔan* 'orchard' and *pū̄aʔat* ← *puat* 'wave' from a Ro'is speaker from Baun. Kotos has *poʔon* 'orchard' and *okin* 'wave'.

- (101) *bahwa, toiʔs=ee na-haan ek nēōno tnanaʔ*
bahwa toʔis=ee na-hana ek neno tnanaʔ
 so.that trumpet=3DET 3-sound LOC day middle
 ‘the trumpet sounds in the middle of the day’ RO-170829-1, 17.13 

The prosodic and morphological structure of Ro's *nēōno tnanaʔ* ‘middle of the day’ is shown in (102b) below alongside the Kotos equivalent *nenō tnanaʔ* in (102a). While morphologically the initial consonant of *tnanaʔ* ‘middle’ is part of the second word, prosodically it is the coda of the previous word, thus triggering diphthongisation of the penultimate vowel of this word in Ro's (102b).

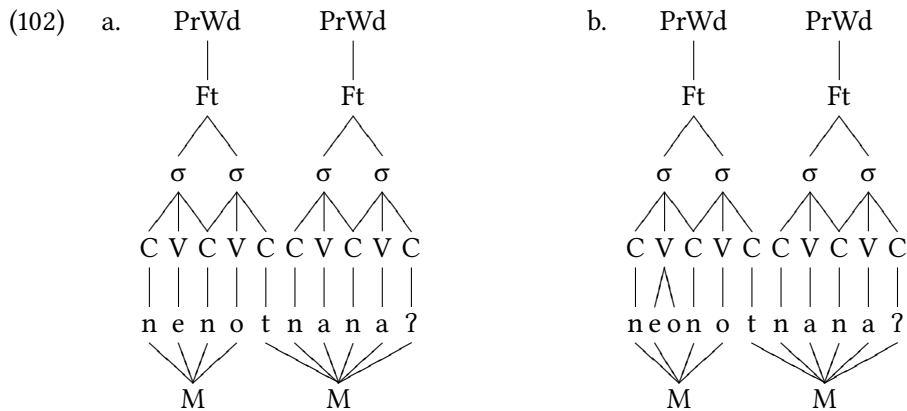

3.4.2 Roots with a consonant cluster (root → C|Ft)

Roots which consist of a single foot preceded by an extra consonant are the second most common type of root in my corpus. 21% (401/1,913) of lexical roots have this shape. Such roots are maximally CCVCVC and minimally CCVV. Examples of each possible shape are given in Table 3.16.²²

Table 3.16 shows that there are more CCVCVC roots than there are CCVCV roots. This is unexpected given that for roots of a single foot there are many more CVCV roots than CVCVC roots (see Table 3.13 on page 135).

One reason for the larger number of CCVCVC roots is because Amarasī has two circumfixes of the shape *ʔ...-ʔ*: a nominaliser and a verbal intensive. In addition to productive uses of these affixes (see §A.2.3), there are many roots with

²²The root *ʔkaunuʔ* ‘bother’ is the only Kotos Amarasī root in my corpus with both a consonant cluster and the initial sequence of two vowels assigned to a single V-slot.

3 Phonology and phonotactics

Table 3.16: Words with a single foot and an extra consonant

Structure	Root	Phonetic		gloss	no.	%
C CVCVC	<i>kbateʔ</i>	[kβaʔɛʔ]	◀◀)	'k.o. edible grub'	188	47%
C CVCV	<i>bkaʔu</i>	[bʔkaʔu]	◀◀)	'fruit bat'	139	35%
C CV V	<i>ʔsao</i>	[ʔ'saɔ]	◀◀)	'viper'	43	11%
C CV VC	<i>snaen</i>	[snaɛn]	◀◀)	'sand'	30	8%

fossilised ʔ...-ʔ. There are 71 CCVCVC roots in my current database which contains a putative fossil of this suffix; constituting 38% of all CCVCVC roots. Two examples are *ʔmukiʔ* 'lime' and *na-ʔsekeʔ* 'force'.

3.4.2.1 Root-initial consonant clusters

The root-initial consonant clusters attested in my corpus are given in Table 3.17 below, with consonants sorted by place of articulation. The consonants *ɕ* and *gw* are not shown as they do not occur in any clusters in Kotos Amarasī.

Table 3.17: Kotos Amarasī root-initial consonant clusters[†]

C ₁ ↓	<i>p</i>	<i>b</i>	<i>m</i>	<i>f</i>	<i>t</i>	<i>n</i>	<i>r</i>	<i>s</i>	<i>k</i>	<i>ʔ</i>	<i>h</i>	C ₂
<i>p</i>						<i>pn</i>	<i>pr</i>	<i>ps</i>				
<i>b</i>					<i>bt</i>	<i>bn</i>	<i>br</i>	<i>bs</i>	<i>bk</i>		<i>bh</i>	
<i>m</i>				<i>mf</i>	<i>mt</i>	<i>mn</i>	<i>mr</i>	<i>ms</i>				
<i>f</i>					<i>ft</i>	<i>fn</i>	<i>fr</i>					
<i>t</i>	<i>tp</i>	<i>tb</i>		<i>tf</i>		<i>tn</i>	<i>tr</i>				<i>th</i>	
<i>n</i>			<i>nm</i>					<i>ns</i>				
<i>r</i>												
<i>s</i>	<i>sp</i>	<i>sb</i>	<i>sm</i>	<i>sf</i>	<i>st</i>	<i>sn</i>	<i>sr</i>		<i>sk</i>			
<i>k</i>	<i>kp</i>	<i>kb</i>	<i>km</i>	<i>kf</i>	<i>kt</i>	<i>kn</i>	<i>kr</i>	<i>ks</i>			<i>kh</i>	
<i>ʔ</i>	<i>ʔp</i>	<i>ʔb</i>	<i>ʔm</i>	<i>ʔf</i>	<i>ʔt</i>	<i>ʔn</i>	<i>ʔr</i>	<i>ʔs</i>	<i>ʔk</i>		<i>ʔh</i>	
<i>h</i>												

[†] *bɕ* occurs in Ro's *bɕʔae* 'cow' (Kotos *biɕʔae*) and *fk* occurs in Tais Nonof *fkuun* 'stars' (Kotos *kfuun*).

While it is difficult to state general restrictions on the appearance of root initial consonant clusters for which exceptions cannot be found, the following preferences can be said to loosely hold. Firstly, clusters of two identical consonants are disallowed root initially (but are allowed word initially in polymorphemic words). Secondly, homorganic clusters are disfavoured root initially. In particular, sequences of two labial consonants are not found, with the exception of the cluster /mf/.²³ Thirdly, most Amarasi root-initial clusters involve either a sonority plateau or sonority rise on the sonority hierarchy: liquid > nasal > fricative > plosive (see Blevins 1995: 210f for an overview of the sonority sequencing principle and sonority hierarchy), though, again, exceptions occur.

Apart from these three general restrictions, other restrictions involve specific consonants. The glottal stop never occurs as the second member of a cluster, while the glottal fricative /h/ and the alveolar liquid /r/ do not occur as the first member of any consonant cluster. The frequency of each attested root-initial cluster is given in Table 3.18 below.²⁴

Table 3.18: Kotos Amarasi root-initial consonant cluster frequencies

$C_1 \downarrow$	<i>p</i>	<i>b</i>	<i>m</i>	<i>f</i>	<i>t</i>	<i>n</i>	<i>r</i>	<i>s</i>	<i>k</i>	<i>ʔ</i>	<i>h</i>	$C_2 \leftarrow$
<i>p</i>						3	2	2				7
<i>b</i>					1	7	8	1	1		1	19
<i>m</i>				1	4	20	1	2				28
<i>f</i>					1	4	5					10
<i>t</i>	1	1		2		9	4				2	19
<i>n</i>			1					1				2
<i>r</i>												
<i>s</i>	6	5	3	1	3	9	9		15			51
<i>k</i>	4	14	7	4	5	21	29	2			3	89
<i>ʔ</i>	19	33	9	10	23	22	14	20	27		9	186
<i>h</i>												
tot.	30	53	20	18	37	95	72	28	43		15	411

Table 3.18 shows that clusters in which the glottal stop is the first consonant greatly outnumber any other cluster. This might indicate that the putative glot-

²³This cluster occurs only in the word *mfaun* ‘many’.

²⁴The frequencies in Table 3.18 include the 401 disyllables with an initial cluster, eight roots larger than a disyllable with an initial cluster, and two monosyllabic functors with an initial cluster.

3 Phonology and phonotactics

tal stop initial clusters are better analysed as a separate series of glottalised or pre-glottalised phonemes. Under this analysis, sequences such as [ʔb] would be analysed as /'b/ or /b'ʔ/.

Comparable phonemes are regionally attested. Examples include Dhao and Hawu (Grimes 2010) as well as some of the Rote languages (Tamelan 2007) in which voiced implosives occur.²⁵ Similarly, Waima'a in eastern Timor has been described with a full series of glottalised consonants (Hajek & Bowden 2002; Hajek & Himmelmann 2006).²⁶

Phonetically, [ʔC] clusters *can* be realised phrase initially as glottalised single segments. Nonetheless, there are four facts which support the consonant cluster analysis in Amarasī.

Firstly, phrase medially the glottal stop of such clusters is realised as a distinct component prior to the following consonant. One example is the word *ʔbaʔa-f* 'roots' in the phrase *hau ʔbaʔa-f* 'tree roots' → [həwʔbaʔef] . Secondly, words which begin with [ʔC] behave like other words which begin with a consonant cluster in usually requiring epenthetic [a] after consonant-final roots (§3.5). We would not expect epenthesis if such roots began with a single phoneme. Thirdly, the first person singular prefix for one verb class consists of a single glottal stop ʔ- (§A.1.1), as does the prefixal component of the nominalising circumfix ʔ-...-ʔ (§A.2.3). When these affixes attach to a stem, the resulting cluster is realised in the same way as an equivalent root-initial cluster. Fourthly, if [ʔC] sequences were underlyingly single segments, they would have a restricted distribution compared to other segments: they cannot occur as part of an initial cluster, root medially, or root finally. These distributional facts are straightforwardly explained by positing that these segments are clusters. They simply fit into the phonotactics structures of Amarasī which does not allow medial or final clusters or initial clusters of more than two consonants.

The best analysis of [ʔC] sequences in Amarasī is that they are clusters of a glottal stop followed by a consonant. There are both historical and typological reasons that such clusters are the most common consonant clusters in Amarasī. Historically, many /ʔC/ clusters come from reduction of an initial prefix *ka-. Similarly, clusters with /k/ as the first member also often arise from reduction of *ka- (Edwards 2018a: 387f) and /kC/ clusters are the second most common kind of cluster. Typologically, it has been proposed that “*The Austronesian languages,*

²⁵Implosives contrast with plain voiced plosives in Dhao and Hawu, while in the Rote languages implosives do not contrast with plain voiced plosives.

²⁶Given the discussion in Donohue (2003), it may be possible to analyse the Waima'a glottalised consonants as underlying consonant clusters involving a glottal stop.

especially in the Timor area, show ample evidence of utilizing laryngeal gestures in some way in their phonologies.” (Donohue 2003: 216). The Amarasi glottal stop initial clusters thus fit into this typological profile.

Finally, it is worth noting that all root-initial glottal stop initial clusters in Kotos Amarasi have been simplified in Ro'is Amarasi through loss of the glottal stop.

3.4.3 Roots with a foot and syllable (Root → σ|Ft)

Roots which consist of a foot preceded by a syllable comprise 9% (178/1,913) of lexical roots I have so far collected. Given that sequences of three vowels do not occur in Amarasi (§3.2.1.4), such roots are maximally CVC|CVCVC and minimally V|CVV. Examples of a range of roots containing a foot and syllable are given in Table 3.19 below.

Table 3.19: Words with a foot and syllable[†]

Structure	Root	Phonetic		gloss	no.	%
(C)V CVCV(C)	<i>mahataʔ</i>	[mə'hətəʔ]	◀)	'itchy'	56	31%
(C)VC CVCV(C)	<i>bankofaʔ</i>	[bən'kofəʔ]	◀)	'caterpillar'	49	28%
(C)V CV V(C)	<i>sekau</i>	[sɛ'kəw]	◀)	'who?'	40	22%
(C)VC CV V(C)	<i>karpeo</i>	[kar'pɛɔ]	◀)	'onion'	28	16%

[†] In addition to the structures given in this Table, I have collected five roots with a syllable and foot which begin with a consonant cluster, all names of trees: *?bakʔuruʔ* 'Morinda citrifolia', *?namee* 'Pipturus argenteus', *?riksusu* 'Wrightia pubescens', *?babuʔi* 'Pipturus argenteus', and *?nankaʔi* 'Albizia chinensis'.

Many roots of this shape are historic compounds or polymorphemic words. Thus, *mahataʔ* 'itchy' is from Proto-Malayo-Polynesian *gatəl > *hata with the property circumfix *ma-...-ʔ* attached (§A.2.2). Similarly, the first part of *sekau* 'who?' is from Proto-Malayo-Polynesian *sai combined with *kau* of unknown origin. Likewise, the second part of *karpeo* 'garlic' is cognate with Amanuban *pio* and Molo *peo* indicating that Amarasi *karpeo* 'garlic' is a historic compound, though the origin of initial *kar* is unclear.²⁷

²⁷Middelkoop (1972: 173) gives Molo <*kalapo*> (possibly with a final double vowel /kalapoo(?)/) as 'weeping paperbark' *Myrtus leucadendra*, a kind of tree with white papery bark. The initial element of <*kalapo*> may well be cognate with the initial element of Amarasi *karpeo*, based on a resemblance between the bark of this tree and the white papery outer skin of garlic bulbs.

3 Phonology and phonotactics

3.4.4 Roots with two feet

Roots with two feet constitute 6% (106/1,913) of my current corpus. Of such roots, the medial C-slot of the initial foot is usually unfilled surfacing as (C)VV(C). This is attested in 69% (73/106) of instances in my corpus. With the exception of loans, all other roots with two feet have an initial foot with the structure (C)VCV which is followed by a medial consonant cluster.

With these considerations in mind, and observing the constraint against sequences of three vowels, the maximal structure of words with two feet is either (C)VV(C)|CV(C)V(C) or (C)VCVC|CV(C)V(C). Examples are given in Table 3.20.

Table 3.20: Roots with two feet[†]

Structure	Phonemic	Phonetic	gloss	no.	%
(C)VV CVCV(C)	<i>paumaka?</i>	[,pəw'makəʔ]	☞ 'near'	38	36%
(C)VVC CVCV(C)	<i>meis?okan</i>	[,mɛjs'ʔəkən]	☞ 'dark(ness)'	21	20%
(C)VVC CV V(C)	<i>riuksaen</i>	[,riʊk'saɛn]	☞ 'python'	10	9%
(C)VCVC CVCV(C)	<i>ata?ra?e</i>	[,ʔaʔa'raʔɛ]	☞ 'praying mantis'	17	16%
(C)VCVC CV V(C)	<i>paratrao</i>	[,paraʔ'raʊ]	☞ 'kingfisher'	9	8%
(C)VV CV V(C)	<i>naiɟeer</i>	[,naj'ɟɛ:r]	☞ 'ginger'	5	5%

[†] In addition to the structures given in this Table, there are three words with two feet and an initial cluster: *?beebnisa?* 'centipede', *?hoesaif* 'ditch', and *?kauboe* 'rattan goad'. There are also three words with an exceptional root structure: *n-?antareek* 'reverse' from Dutch *achteruit/aantrekken*, *n-?istarika* 'ironing' from Dutch *strijken* and *n-sikaroti?* 'hyperactive' from one of the Rote languages, e.g. Termanu *sikiloti*, *sikaloto* (Jonker 1908: 544).

The constraints which apply to the initial foot in words with two feet are due to this foot being an M-form; that is, the form taken by nouns with a following attributive modifier. This means that roots with two feet have a prosodic structure identical to that of a modified nominal phrase (§3.3.4) and all roots with two feet are probably historic compounds.

In some instances one element of the historic phrase is still attested in Amarasi as an independent root. Three probable examples include *saan?oo* 'stick insect', from unattested **sana* with *oo* 'bamboo',²⁸ *faifso?* 'kind of plant fed to pigs', from *fafi* 'pig' with unattested **soso?*, and *enosneer* 'window', from *eno?* 'door' with unattested independent **sneer*.²⁹

²⁸ Charles Grimes (p.c. July 2016) points out that initial **sana* could be connected with PMP **saja* 'bifurcation, fork of a branch' Blust & Trussel (ongoing).

²⁹ The final part of *enosneer* 'window' is from Portuguese *janela* /ʒanela/ 'window' (§3.4.7).

However, in many cases neither of the putative compound elements are currently attested elsewhere in Amarasi. Two examples are *suufnene?* ‘tree snake’ and *meis?okan* ‘dark(ness)’. More exhaustive data on other varieties of Meto and languages of the region may reveal cognates for some of these otherwise unattested elements.

Finally, there are four roots in my current database with five syllables. These are: *baatbos?oo* ‘antlion’, *n-ma?autuu* ‘ram (verb)’, *n-?aka?biɕa?e* ‘walk on one’s hands and feet’ and *aiɕonuus* ‘kind of herb’. Of these the last two are clearly historically polymorphemic. The root *n-?aka?biɕa?e* is from a prefix *?aka?*, attested unproductively on a few other verbs and *biɕae* ‘cow’, while *aiɕonuus* ‘kind of herb’ is from *aiɕo?o* ‘casuarina tree’ combined with *nuus* which has no independent use in Amarasi but means ‘blue’ in some other varieties of Meto.

3.4.5 Monosyllabic roots

The root shapes discussed in the previous sections constitute the vast bulk of all roots in my database and the only shapes with which all but one lexical root occur. There are, however, a number of functors which contain only a single syllable. Nearly half (28/64) of all functors in my database are likely monosyllabic. Examples include the relativiser *re?*, the clitic negators *ka=* and *=fa* as well as conjunctions such as *mes* ‘but’ or *=ma* ‘and’.

There is one lexical root in my database which is monosyllabic: \sqrt{ha} ‘eat soft food’. However, this verb always takes vocalic subject agreement prefixes (§A.1.1), such as *na-ha* ‘3-eat’, providing it with an extra syllable and thus constituting an entire foot.

In my PhD thesis (Edwards 2016b) some functors were analysed as monosyllabic which I now analyse as containing a double vowel. Notably, I analysed many of the vowel-initial enclitics (see Table 5.1 on page 210) as containing a single vowel, such as *=ees* ‘one’, and *=ii* ‘1DET’. Similarly, I analysed the pronouns *hoo* ‘2SG’, *iin* ‘3SG’, *hiit* ‘1PL’, *hii* ‘2PL’, and *siin* ‘3PL’ as containing only a single vowel. I have since gathered comparative data from other varieties of Meto which indicates that such functors have two underlying vowels.³⁰

Thus, evidence that the vowel-initial enclitics have two vowels comes from a process of vowel assimilation in some varieties of Meto, such as Ro’s Amarasi

³⁰My analysis of the pronouns as containing a single vowel was influenced by the practical orthography in which they are written with a single vowel: *hoo* <ho> ‘2SG’, *iin* <in> ‘3SG’, *hiit* <hit> ‘1PL’, *hii* <hi> ‘2PL’, and *siin* <sin> ‘3PL’. However, for many of the vowel-initial enclitics, my analysis was despite the orthography in which most of these enclitics are written with two vowels. Examples include *=ii* <ii> ‘1DET’, *=aan* <aan> ‘2DET’, and *=ee* <ee> ‘3DET’

3 Phonology and phonotactics

(Buraen) *nifu* ‘thousand’ + *=ees* ‘one’ → *niifb=oes* and *meto?* ‘dry, dryness’ + *=ii* ‘1DET’ → *meet?=ui* (see §5.8 for more discussion of these and similar forms) Similarly, for the pronouns Kusa-Manea has *ian* ‘3SG’, *hiat* ‘1PI’, *hei* ‘2PL’, and *sian* ‘3PL’ which unambiguously have two vowels. It possible that more comparative data will lead to reanalysis of some of the remaining putative monosyllabic functors as containing an underlying double vowel.

3.4.6 Root-final consonants

All consonants have been attested in root final position except for the marginal phonemes /ɕ/ and /gw/. Table 3.21 gives the frequency of consonants in root final position compared to their frequency in other positions, arranged by frequency in final position. This count was made on my current dictionary of 2,005 unique roots. This yielded 849 roots which ended in a consonant (42% of all roots).

Table 3.21: Frequency of root final consonants

C	ʔ	n	t	s	k	r	f	h	m	b	p	ɕ	gw
_#	387 46%	132 16%	88 10%	80 9%	54 6%	38 4%	29 3%	14 2%	13 2%	9 1%	2 0.2%	0 0%	0 0%
else.	456 11%	671 16%	500 12%	468 11%	440 11%	428 10%	300 7%	282 7%	235 6%	196 5%	138 3%	11 0.3%	2 0.05%

While all consonants (except /ɕ/ and /gw/) are attested root finally, there is a statistical skewing of which consonants do so, with the glottal stop constituting 46% of root final consonants compared to 11% of consonant phonemes in other root positions.

The labial stops /p/, /b/ and /m/ do not occur finally in any roots with more than two syllables. This apparent restriction is probably the result of the small number of roots of this size combined with the scarcity of the labial consonants root finally. The labial fricative /f/ does occur on roots greater than two syllables and there is a verbal suffix *-b* ‘TR’ and a nominal suffix *-m* ‘1PX/2GEN’ which freely attach to roots of more than two vowels.

3.4.7 Phonotactic nativisation of loan words

Amarasi roots conform to a strict set of structures based on the CVCVC foot. Loanwords with other structures are adapted to conform to this structure. One

common disallowed shape in loans is final CCV#. Amarasi employs one of two strategies to conform such words to the CVCVC foot template. The most common strategy is to metathesise $C_1C_2V\#$ to $C_1VC_2\#$. Examples are shown in Table 3.22.³¹ There is also one clear example of a final CCV# being adapted by doubling the final vowel: *n-saksii* ‘witness’ ultimately from Sanskrit *sākṣi* /sa:kṣi/.³²

Table 3.22: Loanword metathesis

Meaning	Root	Source	Donor
‘party’	<i>fesat</i>	<i> festa</i>	Portuguese
‘examine’	<i>parikas</i>	<i> periksa</i>	via Malay
‘govern(ment)’	<i>prenat</i>	<i> prenta</i>	Kupang Malay
‘dance’	<i>ranas</i>	<i> dansen</i>	Dutch
‘lights’	<i>ramup</i>	<i> lampu</i>	via Malay
‘sign’	<i>tanar</i>	<i> tanda</i>	Malay
‘tent’	<i>tenar</i>	<i> tenda</i>	Portuguese

Table 3.23: Reanalysis of loanwords with enclitic =aa

Gloss	Root	with =aa	Source	Donor
‘deer’	<i>ruus</i>	<i> ruus=aa</i>	<i> rusa</i> /rusa/	via Malay
‘disaster’	<i>siraak</i>	<i> siraak=aa</i>	<i> cilaka</i> /tʃilaka/	via Malay
‘girlfriend’	<i>binoon</i> [†]	<i> binoon=aa</i>	<i> nona</i> /nona/	via Malay
‘minister’	<i>panriit</i>	<i> panriit=aa</i>	<i> paṇḍita</i> /paṇḍita/	ult. Sanskrit
‘chair’ (Ro’is)	<i>kanreer</i>	<i> kanreer=aa</i>	<i> cadeira</i> /kadeira/	Portuguese
‘church’	<i>krei</i>	<i> kreedʒ=aa</i>	<i> igreja</i> /igreza/	Portuguese
‘table’	<i>mei</i>	<i> meedʒ=aa</i>	<i> mesa</i> /meza/	Portuguese
‘window’	<i>enosneer</i> [‡]	<i> sneer=aa</i>	<i> janela</i> /ʒanela/	Portuguese

[†] Initial *bi* in *binoon* is from the feminine article *bi* also used before female proper names.

[‡] Initial *eno* in *enosneer* ‘window’ is from *eno?* ‘door’. The derivation of the final element from Portuguese *janela* /ʒanela/ involves antepenultimate vowel reduction and devoicing of the initial voiced fricative; thus *ʒanela > **sanela > **snela > **snera > **sneer=aa.

³¹ Another possible example is Dutch *mark* > *marak* ‘brand, stamp’, though this could simply show final epenthesis.

³² Another possible example of final vowel doubling is *kantoor* ‘office’. This could be a borrowing directly from Dutch *kantoor* or it could have entered Amarasi via Malay *kantor*.

3 Phonology and phonotactics

Finally, there are half a dozen or so loanwords which have been re-analysed as containing the nominal determiner =aa, with this enclitic then removed to form the root. Examples are given in Table 3.23. While the determiner =aa is not particularly frequent in Kotos Amarasi, in other varieties of Meto it is the most common nominal determiner.

3.5 Epenthesis

When a consonant-final word occurs before a consonant cluster, epenthesis of the vowel [a] usually occurs to break up the cluster. Four examples of epenthesis before a CC-initial root are given in (103)–(105) below. Throughout this book I separate epenthetic /a/ from the stem with the vertical line |.

- (103) [ʔʊmə ʔtɛ t̩ ʊhakəb asnʊkʊ niʊskɔɛ]
uma ʔ-tea =t u-haku-b a|snuku Niuskore
uma ʔ-tea =te u-haku-b snuku Niuskore
1/2SG\come 1SG-arrive =SUB 1SG-force-TR trim Niuskore
'When I arrived I forced myself to do the mowing at Niuskore.' 130825-6,
8.44 🔊
- (104) [nbi nɔmɛr əmsəʔ rɛkɔ]
n-bi nomer a|msaʔ reko
n-bi nomer msaʔ reko
3-RL.LOC number also good
'(writing) on the number is also fine.' 130905-1, 0.34 🔊
- (105) [kʊvɛn ʔaʔpina m faɔf]
kuan a|ʔpina =m faɔf
kuan ʔpina =ma fafo
village below =and above
'(There was) a village down below and up above.' 130823-9, 0.25 🔊

Epenthesis of [a] also optionally occurs before a phrase-initial consonant cluster. Examples have been given in Table 3.12 on page 122 during the discussion of glottal stop insertion.

3.5.1 Frequency of epenthesis

While epenthesis usually occurs to break up a cluster of three consonants which would be created across a word boundary, it is not obligatory. The number of in-

stances of epenthesis after a consonant-final word and before a consonant cluster was counted in my corpus of 182.49 minutes (three hours and two minutes) of recorded Kotos Amarasi texts. The results are summarised in Table 3.24.

Table 3.24: Frequency of epenthesis[†]

C#	<i>p</i>	<i>r</i>	<i>s</i>	<i>b</i>	<i>t</i>	<i>n</i>	<i>f</i>	<i>k</i>	<i>m</i>	ʔ	<i>h</i>	Obs.
C#CC	–	–	3	1	5	23	2	7	2	44	4	18
C#a CC	–	6	60	7	11	42	3	9	2	26	–	96
ep.%	–	100%	95%	88%	69%	65%	60%	56%	50%	37%	0%	84%

[†] The second row gives the number of instances in which each word-final consonant occurs before a consonant cluster without epenthesis and the third row the number of times epenthesis occurs between that consonant and a following cluster.

This table shows that epenthesis usually occurs when the final consonant is an “obstruent” (defined here loosely as any of /p t k b f s r/) with epenthesis occurring before a consonant cluster and after an obstruent in 96/114 (84%) instances. Epenthesis also usually occurs when the final consonant is *n*, though at a lower rate than for obstruents with 42/65 (65%) examples. Epenthesis is least common when the final consonant is a glottal stop with 26/70 (37%) attestations.

3.6 Consonant deletion

Kotos Amarasi does not allow word-final consonant clusters. Thus, the addition of a suffix consisting of a single consonant to a consonant-final stem is not straightforward. In most cases any stem-final consonant is deleted when a mono-consonantal suffix is added. Examples are given in (106) below which shows a number of consonant-final stems with a genitive suffix (§A.3.1). In all cases the final consonant of the stem is replaced by the genitive suffix, including when that final consonant is itself a suffix.³³

³³ Apart from stems with another suffix attached, the only final consonant so far attested with roots which take genitive suffixes is the glottal stop. Historically, this glottal stop is probably itself a suffix (Edwards 2018c: 77), though this analysis does not seem a possible synchronic analysis.

3 Phonology and phonotactics

(106) Final consonant replacement after genitive suffix

<i>eno?</i>	+	-n	→	<i>iin eno-n</i>	‘its door’
<i>reta?</i>	+	-n	→	<i>iin reta-n</i>	‘her/his story’
<i>huma?</i>	+	-k	→	<i>au huma-k</i>	‘my face’
<i>?naka?</i>	+	-k	→	<i>au ?naka-k</i>	‘my head’
<i>a-m-nema-t</i>	+	-n	→	<i>iin a-m-nema-n</i>	‘her/his arrival, origins’
<i>a-reko-t</i>	+	-n	→	<i>iin a-reko-n</i>	‘her/his goodness’

When the people group suffix *-s* attaches to CVC# final stems this suffix replaces the final consonant. However, after VVC# final stems this suffix has the allomorph *-as*. Examples of *-s* are given in (107) below.

(107) People group suffix *-s*

‘Savu’	<i>Sapu</i>	+	-s	→	<i>Sapu-s</i>	‘person from Savu’
‘Rote’	<i>Rote</i>	+	-s	→	<i>Rote-s</i>	‘person from Rote’
‘Koro’oto’	<i>Koor?oto</i>	+	-s	→	<i>Koor?oto-s</i>	‘person from Koro’oto’
‘Belu’	<i>Beru</i>	+	-s	→	<i>Beru-s</i>	‘person from Belu’
‘Kupang’	<i>Kopan</i>	+	-s	→	<i>Kopa-s</i>	‘person from Kupang’
‘Helong’	<i>?Hero?</i>	+	-s	→	<i>?Hero-s</i>	‘Helong person’
‘Buraen’	<i>Buraen</i>	+	-as	→	<i>Buraen-as</i>	‘person from Buraen’
‘Naet’	<i>Naet</i>	+	-as	→	<i>Naet-as</i>	‘person from Naet’
‘east’	<i>neon sae-t</i>	+	-as	→	<i>neon sae-t-as</i>	‘easterner’ ³⁴

These different morphophonemic processes apply with the aim of fitting the derived word into the canonical disyllabic foot shape (§3.3.2). Thus, for *Kopan* ‘Kupang’ → *Kopa-s* ‘person from Kupang’, deletion of the root final consonant means that the derived word, *Kopa-s* is a disyllabic foot. The prosodic and morphological structures of structures of *Kopan* ‘Kupang’ and *Kopa-s* ‘person from Kupang’ are shown in (108) below.

³⁴The form *neon sae-t-as* ‘easterner’ specifically refers to someone from the north-eastern Atoni (Meto speaking) regions: Oecusse (Baikeno), Miomafo, Insana, and Biboki.

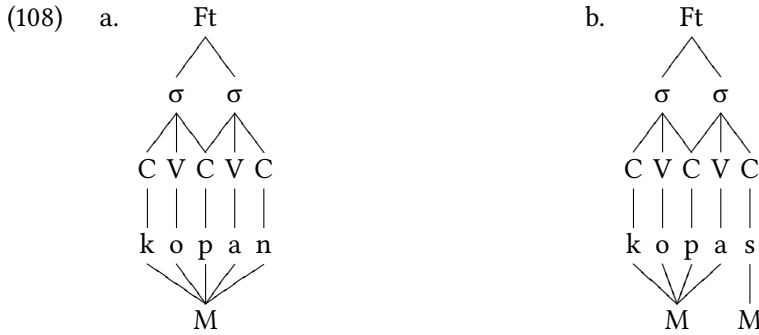

For VVC# final words use of the allomorph *-as* does not result in an increase in word size as both the penultimate and final vowel of the stem can be assigned to a single V-slot (§3.4.1.1). The prosodic and morphological structures of *Naet* → *Naet-as* ‘person from Naet’ are shown in (109) below to illustrate.³⁵ Both words are disyllabic feet, with *Naet* having an empty medial C-slot, as seen in (109a), while *Naet-as* has both its vowels assigned to a single V-slot, as seen in (109b).

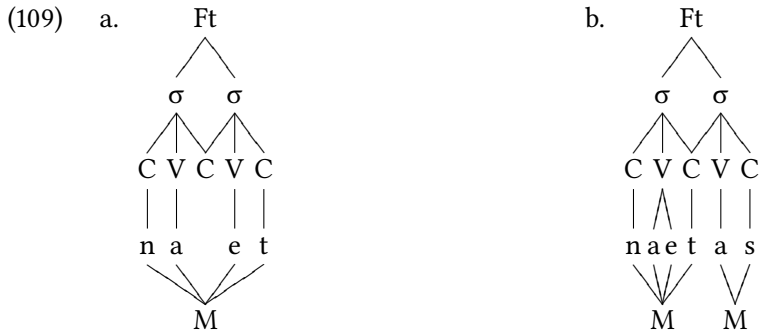

3.6.1 Consonant coalescence

When one of the consonant-final pronouns *iin* ‘3SG, s/he, it’, *siin* ‘3PL, they’ or *hiit* ‘1PL, we’ occurs before a corresponding consonantal agreement prefix *n-* ‘3SG, 3PL’ or *t-* ‘1PL’ which is in turn attached to a consonant-initial stem, the final consonant of the pronoun and the agreement prefix usually coalesce.

In this situation the underlying initial sequence of two identical consonants is usually degeminated: giving $nnC \rightarrow [nC]$ and $ttC \rightarrow [tC]$. This process is summarised in (110a) with examples of each given in (110b).

³⁵Naet is one of the four hamlets which was unified to form the village of Nekmese’ (§1.2.2).

3 Phonology and phonotactics

- (110) a. $iin + n\text{-}C \rightarrow iin\ nC \rightarrow [inC]$
 $siin + n\text{-}C \rightarrow siin\ nC \rightarrow [sinC]$
 $hiit + t\text{-}C \rightarrow hiit\ tC \rightarrow [hitC]$
- b. $iin + n\text{-}mu?i \rightarrow iin\ nmui? \rightarrow [ʔin'mʊiʔ]$ \blacktriangleleft 's/he has'
 3SG 3-have
 $hiit + t\text{-}mese \rightarrow hiit\ tmese \rightarrow [hit'mese]$ \blacktriangleleft 'we are alone'
 1PI 1PI-alone

Evidence that both consonants *do* survive underlyingly comes from the fact that the U-form of these pronouns has been attested in this environment. (See §4.2.5 for a discussion of functor U-forms.) In my corpus there are 2/45 instances of *sina* '3PL' / *_n*-C. Both are examples of the phrase *sina n-mate=n*. One of these examples is given in (111) below.

- (111) [ʔak ej ɔ̣ ka:tʊ sinə 'nma:tɛn baj kʊ:s]
 ʔ-ak: "hei hoo kartu *sina n-mate=n*, baʔi Kus.
 1SG-say hey 2SG card 3PL 3-die=PL PF Kus
 'I said: "hey, your cards have expired Kus.' 130825-6, 7-34 \blacktriangleleft

There are no examples of the U-form of the pronoun *iin* '3SG' or *hiit* '1PI' before an agreement prefix in my database, though Steinhauer (1993: 135) gives examples of the U-form of both these pronouns before their corresponding agreement prefixes in Miomafo.

3.7 Enclitics

There are a number of morphophonemic processes associated with enclitics in Amarasi. Firstly, the host of a vowel-initial enclitic undergoes a number of processes including consonant insertion, metathesis, and vowel assimilation. These processes are the focus of Chapter 5, but I provide a brief overview in this section.

Secondly, some enclitics have multiple forms partly dependent on whether they attach to a vowel-final or consonant-final host. Clitics with multiple forms include the plural enclitic *=ein* (§3.7.2) and the sentence enclitics *=ma* 'and', *=te* 'SUB', and *=fa* 'NEG'.

3.7.1 Vowel-initial enclitics

When vowel-initial enclitics are attached to a CVC# final stem, the stem undergoes metathesis. Examples are given in (112) below.

(112) $C_1VC_2+=V \rightarrow VC_1C_2+=V$

<i>ramup</i>	+	=ee	→	<i>raump=ee</i>	‘the light’
<i>muʔit</i>	+	=ee	→	<i>muiʔt=ee</i>	‘the animal’
<i>tenuk</i>	+	=ee	→	<i>teunk=ee</i>	‘the umbrella’
<i>tenoʔ</i>	+	=ee	→	<i>teonʔ=ee</i>	‘the egg’
<i>ukum</i>	+	=ee	→	<i>uukm=ee</i>	‘the cuscus’

When a vowel-initial enclitic is attached to a vowel-final stem, insertion of *ɟ* or *gw* occurs at the enclitic boundary. The consonant *ɟ* is inserted after the front vowels *i* and *e* and *gw* is inserted after the back vowels *u* and *o*. The final consonant and vowel of the stem metathesise, and the final vowel then assimilates to the quality of the previous vowel. Examples are given in (113) below, with the enclitic =ee ‘3DET’.

(113) $V_\alpha CV_\beta+=V \rightarrow V_\alpha V_\alpha CC_\beta=V$

<i>kreni</i>	+	=ee	→	<i>kreendɟ=ee</i>	‘the ring’
<i>oni</i>	+	=ee	→	<i>oondɟ=ee</i>	‘the bee; the sugar’
<i>uki</i>	+	=ee	→	<i>uukɟ=ee</i>	‘the banana’
<i>nope</i>	+	=ee	→	<i>noopɟ=ee</i>	‘the cloud’
<i>biku</i>	+	=ee	→	<i>biikgw=ee</i>	‘the curse’
<i>tefu</i>	+	=ee	→	<i>teefgw=ee</i>	‘the sugar-cane’
<i>nopu</i>	+	=ee	→	<i>noopgw=ee</i>	‘the grave’
<i>nefo</i>	+	=ee	→	<i>neefgw=ee</i>	‘the lake’

All the morphophonemic processes which occur with vowel-initial enclitics are described and analysed in full detail in Chapter 5, particularly §5.3 and §4.2.2.

3.7.2 Plural enclitic

The plural enclitic has two main allomorphs, =*ein* after consonant-final stems and =*n* after CV# final stems. Examples of each are given in (114) and (115) below. The form of this enclitic and its enclitic host is discussed in full detail in §5.6.

3 Phonology and phonotactics

(114) {PL} → =ein /C#_

<i>anah</i>	→	<i>aanh=ein</i>	‘children’
<i>kaes muti?</i>	→	<i>kaes muit?=ein</i>	‘Europeans’
<i>eno?</i>	→	<i>eon?=ein</i>	‘doors’
<i>tuaf</i>	→	<i>tuaf=ein</i>	‘people’
<i>kuan</i>	→	<i>kuan=ein</i>	‘villages’
<i>n-fesat</i>	→	<i>n-feest=ein</i>	‘(they) throw a party’
<i>na-barab</i>	→	<i>na-baarb=ein</i>	‘(they) prepare’
<i>n-?onen</i>	→	<i>n-?oenn=ein</i>	‘(they) pray’
<i>na-tuin</i>	→	<i>na-tuin=ein</i>	‘(they) follow’

(115) {PL} → =n /CV#_

<i>kase</i>	→	<i>kase=n</i>	‘foreigners’
<i>hutu</i>	→	<i>hutu=n</i>	‘head-lice’
<i>kbiti</i>	→	<i>kbiti=n</i>	‘scorpions’
<i>koro</i>	→	<i>koro=n</i>	‘birds’
<i>tuni</i>	→	<i>tuni=n</i>	‘eels’
<i>n-mo?e</i>	→	<i>n-mo?e=n</i>	‘(they) do/make’
<i>na-tona</i>	→	<i>na-tona=n</i>	‘(they) tell’
<i>n-eki</i>	→	<i>n-eki=n</i>	‘(they) bring’
<i>na-hana</i>	→	<i>na-hana=n</i>	‘(they) cook’

3.7.3 Sentence enclitics

Amarasi has three enclitics which have multiple forms: the connectors =*ma* ‘and’ =*te* ‘SUB’, as well as the negator enclitic =*fa* ‘NEG’. The connector =*ma* is a general conjunction ‘and’, while =*te* is a temporal subordinator. Normally these enclitics occur with the forms given above. An example of each is given in (116)–(118) below.

(116) *n-reuk fanu =te*,
3-pluck eight =SUB

‘As it struck eight o’clock, ...’

130920-1, 0.51 

(117) *iin n-nao n-bi Tofa? na-teef n-ok iin bae-f=ein=ee =ma*
3SG 3-nao 3-RL.LOC Tofa' 3-meet 3-with 3SG mate-GEN=PL=3DET =and

‘He went to Tofa', met with his mates and,’

130920-1, 2.18 

- (118) *au ka= amna-ah bubur =kau =fa!*
 1SG NEG= NML-eat\M porridge =1SG.ACC =NEG
 ‘I don’t eat porridge!’ (*lit.* ‘I’m not a porridge eater!’) 130825-6, 17.02 🔊

The final vowel of these enclitics is often deleted as long as the following word does not begin with a consonant cluster. Examples of each enclitic with the final vowel deleted are given in (119)–(121) below.

- (119) *siin n-topu srain?=ii =m, na-srain sini =m*
sini n-topu srani?=ii =ma na-srani sini =ma
 3PL 3-receive baptism=1DET =and 3-baptise 3PL =and
 ‘they received baptism and they were baptised and ...’ 160326, 10.36 🔊
- (120) *per a|krei. kreedɔ=esa =t, ees.*
per krei krei=esa =te esa
 per week week=one =SUB one
 ‘Per week. One (every) week.’ 120923-1, 12.40 🔊
- (121) *ka= n-heek =kau =f*
ka= n-heke =kau =fa
 NEG= 3-catch =1SG.ACC =NEG
 ‘I didn’t get caught!’ 130825-7, 1.32 🔊

For numerals greater than ten deletion of the final vowel of =*ma* ‘and’ is obligatory and the full form is no longer allowed. A selection of such numerals is given in (122)–(125) below to illustrate. While the full form is ungrammatical in such examples, speakers recognise =*m* as an allomorph of =*ma*.

- (122) *bo? nua =m mese?*
 ten two =and one
 ‘twenty-one’ (21) 🔊
- (123) *bo? fanu =m teun*
 ten eight =and three
 ‘eighty-three’ (83) 🔊
- (124) *natur seo =m bo?=esa =m haa*
 hundred nine =and ten =one =and four
 ‘nine hundred and fourteen’ (914) 🔊
- (125) *nifun nima =m natur hitu =m bo? nee =m faun*
 thousand five =and hundred seven =and ten six and eight
 ‘five thousand seven hundred and sixty-eight’ (5,768) 🔊

3 Phonology and phonotactics

When these enclitics attach to a consonant-final stem, they optionally have vowel-initial forms which begin with [a]. These forms with an initial [a] have some parallels to epenthesis of [a] before consonant clusters (§3.5), though unlike epenthesis glottal stop insertion does not occur with the vowel-initial form of these enclitics.

The negator is only attested with this extra vowel in my natural texts when the final vowel is also deleted while the connectors have been attested with an initial and final vowel, as well as just with an initial vowel. Examples of the connectors with both vowels are given in (126) and (127), while examples of each enclitic only with an initial vowel are given in (126)–(130).

- (126) *ees nai? Nimrot =ama ain Fina*
esa nai? Nimrot =ma ain Fina
 COP Mr. Nimrod =and mother Fina
 ‘It was Nimrod and Fina.’ 130821-1, 7.20 🔊
- (127) *ta-bsoo? ta-mfa-faun =ate es-ees re? ia,*
ta-bso?o ta-mfa~faun =te es~esa re? ia
 1PI-dance 1PI-INTNS~many =SUB INTNS~one REL 1DEM
 ‘When we all dance together one by one like this,’ 130902-1, 3.15 🔊
- (128) *neki=n =am na-?soos?=ein a/n-bi Oe?saο*
neki=n =ma na-?sosa?=eni n-bi Oe?saο
 take=PL =and 3-sell=PL 3-RL.LOC Oe'sao
 ‘(they) take them and sell them in Oe'sao.’ 120715-1, 1.14 🔊
- (129) *?naka? fauk =at nine-f esa =t hoo m-ak: teun*
?naka? fauk =te nine-f esa =t hoo m-ak tenu
 head how.many =SUB wing-0GEN one =SUB 2SG 1PX/2-say three
 ‘(I asked) How many heads, then one wing? you said: three.’ 130914-1,
 0.47 🔊
- (130) *au, au u-krei, au ?-kisasi =t ka= batuur =af.*
au au u-krei, au ?-kisasi =te ka= batuur =fa.
 1SG 1SG 1SG-church 1SG 1SG-service =SUB NEG= true =NEG
 ‘I, I went to church, I went to services, it's not true.’ 130825-6, 2.50 🔊

The vowel-initial forms of the connectors occasionally induce metathesis on their host in the same way as vowel-initial enclitics (§3.7.1). This is uncommon in

my database, with only about half a dozen unambiguous cases.³⁶ Two examples are given in (131) and (132) below.

- (131) *iin aanh=ein na-ʔroo=n =am of neem=n =at of he m-*
ini anah=eni na-ʔroo=n =ma of nema=n =te of he m-
 3SG child=PL 3-far=PL =and later 3\come\̄M=PL =SUB later IRR
 ‘his children are far away, later when they come,...’ 130913-1, 0.35 🔊
- (132) *kaah =te, reʔ iin na-papaʔ =ma iin n-siirk =am iin n-nao piut*
kaah =te reʔ ini na-papaʔ =ma iin n-sirik =ma ini n-nao piut
 NEG =SUB REL 3SG 3-wound =and 3SG 3-spread\̄M =and 3SG 3-go forever
 ‘If not, s/he is wounded and it (the wound) spreads and keeps going (= growing).’ 120923-2, 5.38 🔊

The frequencies of the different forms of each of these enclitics after vowel-final and consonant-final hosts in my corpus of texts are given in Table 3.25. As can be seen from this table, the full form of the negator *=fa* and the connector *=te* are most frequent in all environments. While the full form of *=ma* is overall most common, after vowels the form *=m* is slightly more common.

Table 3.25: Frequency of the forms of sentence enclitics

	<i>ma</i>	<i>m</i>	<i>ama</i>	<i>am</i>	tot.	<i>te</i>	<i>t</i>	<i>ate</i>	<i>at</i>	tot.	<i>fa</i>	<i>f</i>	<i>af</i>	tot.
V_	233	263	0	0	496	332	233	0	0	565	70	38	0	108
C_	121	18	17	73	229	66	18	38	30	151	153	0	2	155
all	354	281	17	72	724	398	251	38	30	716	223	38	2	263

³⁶Many putative cases of *=ama* and *=ate* inducing metathesis on their host are ambiguous as they could be analysed as a combination of the determiner *=aa* followed by the connector.

4 Structure of metathesis

4.1 Introduction

In this chapter I describe and analyse the form of metathesis in Amarasi. At its most simple, metathesis involves the reversal of the final consonant-vowel sequence of a word. One example is the word ‘stone’ which has the unmetathesised form *fatu* [‘faʔʊ] and the metathesised form *faut* [‘fa.ʊʔ]. This example shows the pattern $C_1V_2C_3V_4 \rightarrow C_1V_2V_4C_3$, illustrated in (1) below.

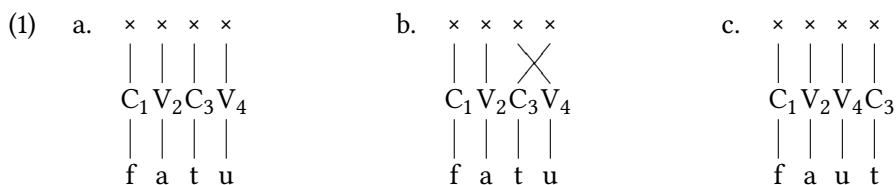

Metathesis is mostly straightforward with words that instantiate all and only CVCV. However, words with other shapes also occur in Amarasi (§3.4). Depending on the phonotactic structure of the word, metathesis is associated with other phonological processes, including vowel deletion, consonant deletion, and two kinds of vowel assimilation. These different processes are illustrated in Table 4.1.

Table 4.1: Phonological processes associated with metathesis

shape	U → M	met.	C# → ∅	/a/ → V ₁	V → HIGH	V# → ∅	
VCV#	<i>fatu</i> → <i>faut</i>	✓					‘stone’
VCVC#	<i>muʔit</i> → <i>muiʔ</i>	✓	✓				‘animal’
VCa#	<i>nima</i> → <i>niim</i>	✓		✓			‘five’
VCV#	<i>ume</i> → <i>uim</i>	✓			✓		‘house’
VVC#	<i>kaut</i> → <i>kau</i>		✓				‘papaya’
VVCV#	<i>aunu</i> → <i>aun</i>					✓	‘spear’
VVCVC#	<i>nautus</i> → <i>naut</i>		✓			✓	‘beetle’

4 Structure of metathesis

From the examples in Table 4.1, it is clear that many of the forms before and after the arrow do not differ only in the order of the final CV sequence. This is the reason for referring to forms paradigmatically equivalent to *fatu* ‘stone’ as the ‘U-form’ and forms paradigmatically equivalent to *faut* ‘stone’ as the ‘M-form’.

By positing an obligatory CVCVC foot in which C-slots can be empty, under a process-based model of morphology and an autosegmental model of phonology, all the phonological processes in the formation of the M-form arise from a single rule of metathesis at the CV tier, an associated morphemically conditioned rule, and the general phonotactic constraints of Amarasí. This analysis is superior to alternate analyses under different frameworks, such as prosodic morphology, or purely concatenative morphology, which cannot account for all the data in a consistent, typologically plausible manner.

For some word shapes it is possible to identify formally distinct M-forms which occur in different environments. The distribution of each of these three M-forms is summarised in Table 4.2.

Table 4.2: M-forms of *mu?it* ‘animal’ and *fatu* ‘stone’

U-form		M-forms	gloss	environments	
<i>mu?it</i>	→	<i>mui?</i>	\M	(C)V-initial nominal modifiers,	§4.2
<i>fatu</i>		<i>faut</i>		default verbal form	
	→	<i>mu?i</i>	\M̄	CC-initial modifiers	§4.6
		<i>fatu</i>			
	→	<i>mui?t</i>	\M̄	vowel-initial enclitics	Ch. 5
		<i>faatgw</i>			

Firstly, there is the basic M-form which is the form taken by nouns when modified by another nominal and which is also the default form of vowel-final verbs. Examples include *fatu* → *faut* ‘stone’ and *mu?it* → *mui?* ‘animal’. Basic M-forms are indicated with the gloss ‘\M’. Their structure is discussed in §4.2.

Secondly, there is an M-form taken by nominals when modified by a word with an initial consonant cluster. One example is *mu?it* → *mu?i* ‘animal’. These M-forms are indicated with the gloss ‘\M̄’. Their structure is discussed in §4.6.

Thirdly, there is an M-form taken by all words before vowel-initial enclitics. Examples include *fatu* → *faatgw* ‘stone’ and *mu?it* → *mui?t* ‘animal’. M-forms before enclitics are indicated with the gloss ‘\M̄’. Unlike the other M-forms, M-forms used before enclitics can be analysed as purely phonologically conditioned and their structure is described and analysed in Chapter 5.

The M-forms discussed in this chapter are the M-forms with a morphological use: the basic M-form (\setminus_M) and the \hat{M} -form used before attributive modifiers with an initial consonant cluster.

While these two forms occur in different phonological environments, this does not mean that the use of these forms is triggered by these environments. Instead, which form is used is triggered by syntactic or discourse factors. An analogy is the English verbal third person singular agreement suffix *-s*. This suffix has three forms */əz/*, */z/* and */s/*, each of which is used in different environments. When the English 3SG agreement suffix occurs, it has different forms as determined by its phonological environment. However, it is not these phonological environments which determine whether this suffix occurs or not; instead, morphosyntactic factors determine this.

While the focus in this chapter is on the structure of metathesis in Kotos Amarasi as spoken in Nekmese' by inhabitants of the old hamlet of Koro'oto, I provide comparative data from other varieties of Meto when they are known to differ from Kotos Amarasi.

4.2 Basic M-form

In this section I describe the structure of the basic M-form. This is the form taken by nouns when modified by a nominal which does not begin with a consonant cluster and is the default form for vowel-final verbs. While the functions of these M-forms are described in full detail in chapters 6 and 7, I provide here a brief overview as context for the following discussion.

Within the noun phrase M-forms are a construct form (§2.6.1) used when an attributive modifier occurs within the noun phrase. Compare examples (2) and (3). Each phrase consists of the noun *fatu* ~ *faut* 'stone' followed by the modifier *koʔu* 'big, great'. In (2) *fatu* 'stone' is in the U-form and the modifier has a predicative reading. In (3) *faut* 'stone' is in the M-form, and the modifier has an attributive meaning. The syntactic structures of each of these phrases are represented with trees in (4) and (5) respectively.

- (2) [_{NP} *fatu*] [_{NP} *koʔu*]
 stone big
 'Stones are big.'

- (3) [_{NP} *faut koʔu*]
 stone big
 '(a) big stone'

4 Structure of metathesis

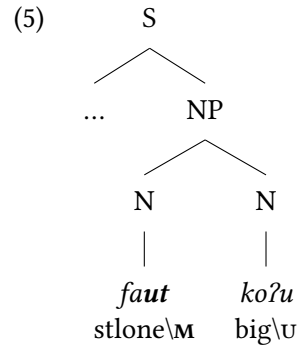
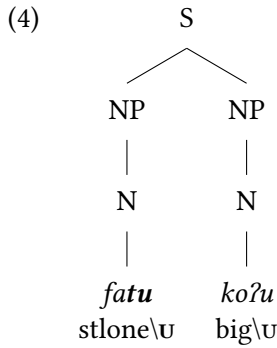

A number of different phonological processes occur in the formation of the basic M-form according to the shape of the U-form stem. These processes include metathesis (§4.2.1), consonant deletion (§4.2.3.1, §4.2.3.2), two kinds of vowel assimilation (§4.2.2), and vowel deletion (§4.2.4).

4.2.1 Metathesis

When a root ends in VCV#, the M-form is formed by metathesis of the final consonant-vowel sequence. The surface relationship between the segments of *fatu* [faʔʊ] → *faut* [fa.ʊʔ] ‘stone’ is shown in (6), with more examples in (7).

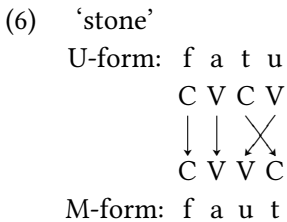

(7) ...V₁CV₂# → ...V₁V₂C#

U-form	M-form		U-form	M-form			
<i>fini</i>	→	<i>fiin</i>	‘seed’	<i>nenō</i>	→	<i>neon</i>	‘day; sky’
<i>besi</i>	→	<i>beis</i>	‘knife’	<i>knafo</i>	→	<i>knaof</i>	‘mouse’
<i>fafi</i>	→	<i>faif</i>	‘pig’	<i>koro</i>	→	<i>koor</i>	‘bird’
<i>oni</i>	→	<i>oin</i>	‘bee’	<i>hitu</i>	→	<i>hiut</i>	‘seven’
<i>uki</i>	→	<i>uik</i>	‘banana’	<i>tenu</i>	→	<i>teun</i>	‘three’
<i>rene</i>	→	<i>reen</i>	‘field’	<i>fatu</i>	→	<i>faut</i>	‘stone’
<i>bare</i>	→	<i>baer</i>	‘place’	<i>nopu</i>	→	<i>noup</i>	‘hole’
<i>nope</i>	→	<i>noep</i>	‘cloud’	<i>hutu</i>	→	<i>huut</i>	‘louse’

It is worth emphasising that in most cases the order of the final consonant and vowel of the word is the only phonetic difference between the U-form and the M-form of VCV# final roots. Metathesis is not accompanied by any reduction in the number of syllables nor by any change in the placement of stress.¹

Such metathesis applies to all VCV# final roots, with the exception of roots in which the final vowel is /a/ (§4.2.2.2) or when the penultimate vowel is high and the final vowel is mid (§4.2.2.1). Such roots undergo metathesis followed by vowel assimilation.

4.2.2 Vowel assimilation

Two kinds of vowel assimilation occur in the derivation of Amarasi M-forms: mid vowel height assimilation and assimilation of final /a/.

4.2.2.1 Mid vowel assimilation

When the final vowel is mid and the penultimate vowel is high, the penultimate vowel is raised to high after metathesis. The surface relationship between the U-form and M-form of *tune* [ˈtʊnɛ] → *tuin* [ˈtʊ.in] ‘gewang palm’ is shown in (8) below, with more examples given in (9).

(8) ‘gewang’

U-form: t u n e
 C V C V
 ↓ ↓ ↘
 C V V C

M-form: t u>i n

(9) ...V₁[+HIGH]C₁V₂[-HIGH,-LOW]# → ...V₁[+HIGH]V₂[+HIGH]C₁#

U-form	→	M-form	
<i>ume</i>	→	<i>uim</i>	‘house’
<i>pune?</i>	→	<i>puin</i>	‘grain-head’
<i>tune</i>	→	<i>tuin</i>	‘gewang palm’
<i>nine?</i>	→	<i>niin</i>	‘edge; wing’
<i>na-hine</i>	→	<i>n-hiin</i>	‘knows’
<i>n-simo</i>	→	<i>n-sium</i>	‘receives (poetic)’

¹The only exceptions are words with identical penultimate and final vowels such as *fini* [ˈfɪni] → *fiin* [ˈfɪ:n] ‘seed’, in which case there is a reduction in the number of phonetic syllables and thus arguably also in the placement of stress. As discussed in §3.2.1.4.1 there is no basis for analysing sequence of two identical vowels differently from sequences of different vowels.

4 Structure of metathesis

Words with this shape are uncommon in my corpus with only 26 attestations out of a total of 1,913 unique lexical roots (1.4%). Additionally, the majority of such words have variant U-forms in which the final vowel is raised to high. Examples include *ume* ~ *umi* ‘house’, *tune* ~ *tuni* ‘gewang palm’, *na-hine* ~ *na-hini* ‘knows’, and *nine?* ~ *nini?* ‘edge; wing’.

Vowel sequences of a high vowel followed by a mid vowel are not found in Amarasí; there are no attestations of **ie*, **io*, **ue* or **uo*. For this reason, the mid vowel assimilation observed when the final vowel is high and the penultimate vowel is mid can be explained by the phonotactic constraints of the language.

Different kinds of height assimilation occur to different extents in other varieties of Meto. For instance, in some varieties of Baikeno /e/ is not raised after /u/, as seen in *ume* → *uem* ‘house’, though it is raised after /i/, as seen in *na-hine* → *na-hiin* ‘know’. On the other hand, in some varieties of Baikeno, Miomafo, Amanuban, and Amanatun high vowels lower to mid after /a/. Baikeno examples include *asu* → *aos* ‘dog’, *manu* → *maon* ‘chicken’, *n-ami* → *n-aem* ‘look for’, and *lasi* → *laes* ‘matter’.

4.2.2.2 Assimilation of /a/

The second kind of vowel assimilation in the formation of M-forms is assimilation of /a/. The M-form of words which end in CVa# is formed via consonant-vowel metathesis with complete assimilation of /a/ to the quality of the first vowel. The surface relationship between the forms *nima* [nime] → *niim* [ni:m] ‘five’ is shown in (10). More examples are given in (11).

(10) ‘five’

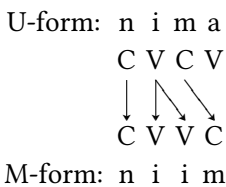

(11) ...V_αCa# → ...V_αV_αC#

U-form	M-form		U-form	M-form	
<i>nima</i>	→ <i>niim</i>	‘five’	<i>n-biba</i>	→ <i>n-biib</i>	‘massage’
<i>n-nena</i>	→ <i>n-neen</i>	‘hears’	<i>fefa-f</i>	→ <i>feef</i>	‘mouth’
<i>n-sosa</i>	→ <i>n-soos</i>	‘buys’	<i>sona-f</i>	→ <i>soon</i>	‘palace’
<i>n-tupa</i>	→ <i>n-tuup</i>	‘sleeps’	<i>sunaf</i>	→ <i>suun</i>	‘horn’

Vowel sequences in which the second vowel is /a/ freely occur before consonants in U-forms, with 55 examples in my database. Examples include *siah* ‘part of the loom’, *mneas* ‘hulled rice’, *koa?* ‘friarbird’, and *kuan* ‘village’.

The assimilation of /a/ in M-forms is an example of a derived environment effect (Kiparsky 1973; Kenstowicz & Kisseberth 1977), a phonological rule which only operates after the application of another rule. In this case, metathesis triggers assimilation of /a/.

Assimilation of /a/ after metathesis is regionally common. It is attested in most varieties of Meto for which data is available, as well as Mambae (§2.3.8) and Funai Helong (§2.3.9). However, there are at least two cases from Meto in which final /a/ does not assimilate after metathesis.

Firstly, in Kusa-Manea final /a/ is preserved after metathesis. Examples of Kusa-Manea forms with final /a/ retained after metathesis are given in Table 4.3 alongside their unmetathesised and metathesised Kotos Amarasi cognates for comparison. Table 4.3 also shows several nouns metathesised before a vowel-initial enclitic (Chapter 5).

Table 4.3: Kusa-Manea M-forms with final /a/

Kotos Amarasi		Kusa-Manea	
U-form	M-form	M-form	gloss
<i>nima</i>	<i>niim</i>	<i>niam</i>	‘five’
<i>n-nena</i>	<i>n-nean</i>	<i>nean</i>	‘hear’
<i>nema</i>	<i>neem</i>	<i>neam</i>	‘(s/he) comes’
<i>n-sena</i>	<i>n-seen</i>	<i>sean</i>	‘plant (v.)’
<i>na-tefa</i>	<i>na-teef</i>	<i>na-teaf</i>	‘meet’
<i>n-ro?a</i>	<i>n-roo?</i>	<i>roa?</i>	‘vomit’
<i>n-sosa</i>	<i>n-soos</i>	<i>soas</i>	‘buy’
<i>na-?ura</i>	<i>na-?uur</i>	<i>na-?uar</i>	‘rain’
<i>n-runa</i>	<i>n-ruun</i>	<i>ruan</i>	‘tattoo’
<i>sunan</i>	<i>suun-n=aa</i>	<i>suan-n=aa</i>	‘horn’
<i>bonak</i>	<i>boonk=aa</i>	<i>boank=aa</i>	‘pandanus’
<i>funan</i>	<i>fuunn=aa</i>	<i>fuann=aa</i>	‘moon’

That this is not a process of dissimilation of the second vowel of a sequence is shown by forms such as Kusa-Manea *ba-booh* ‘cough’ and *skiik* ‘brush teeth’ each of which can be compared with Amarasi *n-boho* → *n-booh* ‘cough’ and *na-skiki* → *na-skiik* ‘brush teeth’.

4 Structure of metathesis

Secondly, assimilation of /a/ does not occur in Ro'is Amarasi after metathesis when the consonant before the final vowel is a glottal stop. Examples are given in Table 4.4 which shows a number of Ro'is metathesised ?a(C)# final words alongside their U-forms and Kotos cognates. There is some evidence that final /a/ does undergo assimilation after the glottal stop in Ro'is for M-forms marking nominal attributive modification, though there is only one example in my database: *keʔan* 'room' + *susu-f* 'corner' → *keeʔ susu-f* 'corner of a room'. If this is a regular pattern, it would be consistent with the data from consonant deletion whereby the M-forms marking nominal attribution have an additional phonological process compared with other M-forms.

Table 4.4: Ro'is Amarasi M-forms with final /a/?[†]

Ro'is Amarasi		Kotos Amarasi		
U-form	M-form	U-form	M-form	gloss
<i>poʔan</i>	<i>poaʔn=ini</i>	<i>poʔon</i>	<i>pooʔn=eni</i>	'orchard(s)'
<i>n-peʔa</i>	<i>n-peaʔ</i>	<i>n-peʔe</i>	<i>n-peeʔ</i>	'break, crack'
<i>na-koʔan</i>	<i>na-koaʔn</i>	<i>na-koʔon</i>		'bark (dog)'
<i>amfoʔan</i>	<i>amfoaʔn</i>	<i>amfoʔan</i>		'Amfo'an'
<i>na-peʔan</i>	<i>na-peaʔn</i>			'create'
	<i>n-roaʔ</i>	<i>n-roʔa</i>	<i>n-rooʔ</i>	'vomit'
	<i>n-tuaʔ</i>	<i>n-tuʔu</i>	<i>n-tuuʔ</i>	'end'
	<i>n-poaʔ</i>	<i>n-poʔo</i>	<i>n-pooʔ</i>	'herd'
	<i>n-riaʔ</i>	<i>n-riʔi</i>	<i>n-riiʔ</i>	'fold'
	<i>triaʔ-n=aa</i>	<i>triʔi-f</i>		'cubital fossa'

[†] Empty cells are currently unattested. Some Kotos U-forms have assimilation of final /a/ after a glottal stop to the quality of the penultimate vowel.

While only /a/ undergoes complete assimilation in Kotos Amarasi, in some other varieties of Meto *all* vowels undergo assimilation after metathesis. Varieties in which this has been attested to some extent include Baikeno, Amfo'an, Timaus, Kopas, and Miomafo. Examples of vowel assimilation after metathesis from Naitbelak Amfo'an are given in Table 4.5.

Complete vowel assimilation in Naitbelak Amfo'an means that the allophones of the mid vowels /e/ and /o/ are marginally contrastive in this variety. As discussed in §3.2.1, the mid vowels are realised as mid-high [e] and [o] before high vowels and as mid-low [ɛ] and [ɔ] elsewhere. In Naitbelak Amfo'an these vowels often retain this quality after assimilation of the conditioning vowel. This results

Table 4.5: Amfo'an (Naitbelak) vowel assimilation after metathesis

U-form	Amarasi M-form	Amfo'an M-form	gloss
<i>hitu</i>	<i>hiut</i>	<i>hiit</i>	'seven'
<i>n-inu</i>	<i>n-iun</i>	<i>n-iin</i>	'drink'
<i>na-kinu</i>	<i>na-kiun</i>	<i>na-kiin</i>	'spit'
<i>na-r/leko</i>	<i>na-reok</i>	<i>na-leek</i>	'good'
<i>na-henu</i>	<i>na-heun</i>	<i>na-heen</i>	'fill'
<i>tenu</i>	<i>teun</i>	<i>teen</i>	'three'
<i>n-mani</i>	<i>n-main</i>	<i>a/n-maan</i>	'laugh'
<i>n-mate</i>	<i>n-maet</i>	<i>a/n-maat</i>	'die'
<i>n-hake</i>	<i>n-haek</i>	<i>a/n-haak</i>	'stand'
<i>fanu</i>	<i>faun</i>	<i>faan</i>	'eight'

in contrasts such as *na-leko* 'is good' → *na-leok* → *na-leek* → [na'lɛ:k] and *na-henu* → *na-heun* → *na-heen* → [na'hɛ:n]. Steinhauer (1993; 1996a,b) reports a similar phenomenon in his Miomafo data.

Kirsten Culhane (p.c. October 2018) reports that in Nai'bais Amfo'an all vowels undergo complete assimilation after metathesis except for *io*, for which only height assimilation is unattested (e.g. *n-simo* → *n-sium* 'receive'), as well as *oi* and *oe*, for which full assimilation is optional.

4.2.2.3 Quantification of M-forms ending in $V\alpha V\alpha C$

In my description, words ending in $VCa\#$ and $V_\alpha CV_\alpha\#$ yield M-forms ending in a sequence of two identical vowels followed by a consonant; $V_\alpha V_\alpha C\#$. This differs from previous descriptions of Meto, which report deletion of the final vowel, with no further changes (Steinhauer 1993; 1996a,b; McConvell & Kolo 1996; Blevins & Garrett 1998; Steinhauer 2008).

I have not found vowel deletion of this kind for any variety of Meto for which I have data. Instead, with the exception of Kusa-Manea, for which $VCa\#$ words simply metathesise, the M-form of such words has a sequence of two identical vowels. This was demonstrated for Amarasi by refining the instrumental acoustic study of vowel length summarised in §3.2.1.4.3 (see Table 3.4 on page 99), in which I showed a sequence of two identical vowels is on average 31% longer than a single vowel in Amarasi.

4 Structure of metathesis

I further refined this study by separating vowel sequences created through metathesis from vowel sequences which are underlying in U-forms. Of the 314 sequences of identical vowels measured, 242 represent a sequence of identical vowels in an M-form, such as *nima* → *niim* ‘five’ or *fini* → *fiin* ‘seed’ and 72 represent words which contain a sequence of two identical vowels in the U-form, such as *too* ‘citizens’ or *toon* ‘year’. The average lengths of each of these kinds of words is given in Table 4.6.

Table 4.6: Sequences of identical Vowels in M-forms and U-forms

$V_{\alpha}V_{\alpha}(C)\#$	all	U-form	M-form	V
average length (sec.)	0.129	0.127	0.129	0.098
number of tokens	314	72	242	472
standard deviation	0.05	0.059	0.047	0.034
t-test (vs. M-form)		$p = 0.759$		$p < 0.001$

Table 4.6 shows that vowel sequences created through metathesis are on average 31% longer than a single vowel in Amarasi. This difference is statistically significant, as shown by a two tailed t-test. Sequences of two identical vowels created through metathesis are also a fraction longer than those which are underlying in U-forms. This difference is not statistically significant.²

Given this acoustic analysis, the simplest analysis of the data is to propose that words whose U-forms ends in $VCa\#$ or $V_{\alpha}CV_{\alpha}\#$ have M-forms with a double vowel in Amarasi. This is the pattern for all lexical words in Amarasi. There are a small number of functors in Amarasi for which the M-form is formed by deletion of the final vowel. Such examples are discussed in §4.2.5.

Data collected from other varieties of Meto, including Amanatun, Amanuban, Amfo'an, Baikeno, Fatule'u, Kopas, Ketun, Kusa-Manea, Molo, and Timaus provides no evidence that U-forms ending in $VCa\#$ or $V_{\alpha}CV_{\alpha}\#$ derive their M-form by final vowel deletion. Thus, earlier reports of vowel deletion in such forms appear to have arisen due to the realisation of two identical vowels as a single long vowel (§3.2.1.4.1), with analysts interpreting phonetically long vowels as a realisation of a single vowel.

²Separating M-forms created through metathesis and assimilation of final /a/, (e.g. *nima* → *niim* ‘five’) from those created through metathesis with identical penultimate and final vowels, (e.g. *fini* → *fiin* ‘seed’), revealed no statistically significant differences.

4.2.3 Consonant deletion

Word-final consonants of nominals are deleted in the formation of the M-form. This process is unique to the derivation of nominal M-forms and does not affect other word classes, of which the largest is verbs. This means that consonant-final verbs, such as *na-tuin* ‘follow’ or *n-bo?is* ‘praise’ do not have basic M-forms.

4.2.3.1 Metathesis and consonant deletion

Words with a final consonant (CVC#) derive their M-form through metathesis of the penultimate consonant with the final vowel and deletion of the final consonant. The surface relationship between *mu?it* [mʊʔit] → *mui?* [mʊ.iʔ] ‘animal’ is shown in (12) below, with more examples given in (13).

(12) ‘animal’

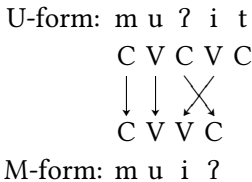

(13) ...V₁C₁V₂C₂# → ...V₁V₂C₁#

U-form	M-form	U-form	M-form
<i>mu?it</i>	→ <i>mui?</i> ‘animal’	<i>po?on</i>	→ <i>poo?</i> ‘orchard’
<i>tenuk</i>	→ <i>teun</i> ‘umbrella’	<i>o?of</i>	→ <i>oo?</i> ‘pen, corral’
<i>teno?</i>	→ <i>teon</i> ‘egg’	<i>manus</i>	→ <i>maun</i> ‘betel vine’
<i>ukum</i>	→ <i>uuk</i> ‘cuscus’	<i>anah</i>	→ <i>aan</i> ‘child’

Word-final consonant clusters are not permitted in Amarasi. The consonant deletion in the M-form of VCVC# final words can be accounted for by language specific phonotactic constraints. Metathesis occurs, resulting in a disallowed final consonant cluster which is resolved by deletion of the final consonant.

In Ro’s Amarasi some consonant-final words with certain phonological properties (see §7.11.1) have two M-forms: an M-form derived in the same way as Kotos Amarasi by metathesis and deletion of the final consonant, and an M-form derived by metathesis but with preservation of the final consonant cluster. Examples of Ro’s nouns which have been attested with this second CC-final M-form are given in Table 4.7 alongside Kotos U-forms and Kotos/Ro’s basic M-forms.

4 Structure of metathesis

Table 4.7: Ro'is Final Consonant Clusters[†]

Kotos U-form	Ro'is U-form	Ro'is CC# M-form	Kotos/Ro'is M-form	gloss
<i>batan</i>	<i>batan</i>	<i>baatn</i>	<i>baat</i>	'generation'
<i>funan</i>	<i>funun</i>	<i>fuunn</i>	<i>fuun</i>	'month'
<i>knapan</i>	<i>knapan</i>	<i>knaapn</i>	<i>knaap</i>	'butterfly'
<i>manas</i>	<i>manas</i>	<i>maans</i>	<i>maan</i>	'sun'
<i>metan</i>	<i>meten</i>	<i>meetn</i>	<i>meet</i>	'black'
<i>prenat</i>	<i>prenet</i>	<i>preent</i>	<i>preen</i>	'government'
<i>ranan</i>	<i>ranan</i>	<i>raann</i>	<i>raan</i>	'road'
<i>surat</i>	<i>surut</i>	<i>suurt</i>	<i>suur</i>	'paper'
<i>uran</i>	<i>urun</i>	<i>uurn</i>	<i>uur</i>	'rain'
<i>amfoʔan</i>	<i>amfoʔan</i>	<i>amfoaʔn</i>		'Amfo'an'
<i>benas</i>	<i>fenes/fenas</i>	<i>feens</i>		'machete'
<i>bonak</i>	<i>bonak</i>	<i>boonk</i>		'fragrant pandanus'
<i>ekam</i>	<i>erem/eram</i>	<i>eerm</i>		'wild pandanus'
<i>koor_kapiten</i>	<i>koor_kapitin</i>	<i>koor_kapiitn</i>		'swiftlet'
<i>kopan</i>	<i>kopon/kopan</i>	<i>koopn</i>		'Kupang'
<i>ksamun</i>	<i>ksaunum</i> [‡]	<i>ksaunm</i>		'starling'
<i>oras</i>	<i>oros</i>	<i>oors</i>		'time'
<i>ruman</i>	<i>rumun</i>	<i>ruumn</i>		'empty'
<i>ukum</i>	<i>urum</i>	<i>uurm</i>		'cuscus'
<i>?henes</i>	<i>henes</i>	<i>heens</i>		'winter melon'
<i>anin</i>		<i>ainn</i>	<i>ain</i>	'wind'
<i>menas</i>		<i>meens</i>	<i>meen</i>	'sickness'
<i>krisan</i>		<i>kriisn</i>		'red-cheeked parrot'
<i>meisʔokan</i>		<i>meisiʔnoorn</i>		'dark(ness)'
<i>nini_tboran</i>		<i>niin_tboorn</i>		'dollarbird'
<i>ninik</i>		<i>niink</i>		'wax'
<i>onen</i>		<i>oenn</i>		'prayer'
<i>paah_pinan</i>		<i>paah_piinn</i>		'earth, world'
<i>pinis</i>		<i>piins</i>		'dew'

[†] Empty cells indicate forms which are currently unattested in my data.

[‡] One of Kotos *ksamun* or Ro'is *ksaunum* 'startling' has undergone historical metathesis of the penultimate and final consonants. Ro'is *ksaunum* further has diphthongisation (§3.4.1.2).

The Ro'is M-forms with final consonant deletion are used to mark attributive modification in the same way as their Kotos equivalents. Ro'is M-forms with a final cluster are used phrase finally with a discourse function like Kotos verbs, where U-forms mark lack of resolution and M-forms resolution (Chapter 7).

The data from Ro'is Amarasi in which certain word-final consonant clusters are permitted phrase finally indicates that the deletion of final consonants in the basic M-form is not simply due to a general prohibition against word-final clusters but rather against word-final consonant clusters in medial members of the noun phrase. Additional evidence for this comes from Amfo'an, in which certain CVC# final words delete their final consonant without metathesis when modified. This Amfo'an data is discussed in §4.5.3.

4.2.3.2 Consonant deletion

Nominals which end in VVC# in the U-form derive their M-form by deletion of the final consonant. The surface relationship between the segments of *kaut* [kə.ʊt] → *kau* [kə.ʊ] 'papaya' is shown in (14), with more examples in (15). Assimilation of /a/ does not occur in such M-forms. In §4.2.2.2 I analyse this as being due to a final empty C-slot in the M-form of these words.

- (14) 'papaya'
 U-form: k a u t
 C V V C
 ↓ ↓ ↓
 C V V
 M-form: k a u

- (15) ...VVC# → ...VV#

U-form	M-form	U-form	M-form
<i>kaut</i>	→ <i>kau</i> 'papaya'	<i>kuan</i>	→ <i>kua</i> 'village'
<i>bruuk</i>	→ <i>bruu</i> 'pants'	<i>?naef</i>	→ <i>?nae</i> 'old man'
<i>knaaʔ</i>	→ <i>knaa</i> 'beans'	<i>poes</i>	→ <i>poe</i> 'prawn/shrimp'
<i>heum</i>	→ <i>heu</i> 'mango'	<i>noah</i>	→ <i>noa</i> 'coconut'

Unlike the consonant deletion seen for VCVC# words (§4.2.3.1), this consonant deletion cannot be accounted for by surface phonotactic constraints of the language. By positing medial empty C-slots this consonant deletion can be analysed as an automatic result of metathesis and a prohibition against word-final consonant clusters, including clusters involving empty C-slots.

4.2.4 Vowel deletion

The final complication in the formation of the basic M-form involves words which end in VVCV(C)# in the U-form; words with a phonetic diphthong. Such words derive their M-form by deletion of the final vowel as well as any final consonant. The surface relationship between the segments of the U-form and M-form of *nautus* [nəwʈʊs] → *naut* [nə.ʊʈ] ‘beetle’ is given in (16), with more examples given in (17) below.

(16) ‘beetle’

U-form: n a u t u s
 C V V C V C
 ↓ ↓ ↓ ↓
 C V V C

M-form: n a u t

(17) ..V₁V₂C₁V₃(C₂)# → ...V₁V₂C₁#

U-form	M-form	U-form	M-form
<i>aunu</i>	→ <i>aun</i> ‘spear’	<i>nautus</i>	→ <i>naut</i> ‘beetle’
<i>n-aiti</i>	→ <i>n-ait</i> ‘pick up’	<i>kaunaʔ</i>	→ <i>kaun</i> ‘snake’
<i>n-aena</i>	→ <i>n-aen</i> ‘run, flee’	<i>aikaʔ</i>	→ <i>aik</i> ‘thorn’
<i>uabaʔ</i>	→ <i>uab</i> ‘speech’	<i>aina-f</i>	→ <i>ain</i> ‘mother’

Sequences of three surface vowels do not occur in Amarasī. Thus, this vowel deletion can be analysed as resulting from phonological constraints of the language. If consonant-vowel metathesis were to occur, it would result in a disallowed sequence of three vowels which is resolved by vowel deletion.

4.2.5 Irregular M-forms and U-forms

There are a handful of morphemes in my database which have irregular M-forms. Firstly, the plural enclitic =*enu* has the M-form =*uun* with irregular assimilation of the initial vowel. This plural enclitic is uncommon in my data. Instead, the form =*eni*/=e*in* is most frequent (§5.6).

Secondly, *aiɕoʔo* ‘casuarina tree’ and *naisoʔo* ‘garlic, shallot’ have M-forms derived by deleting the final /ʔo/ sequence. Examples include *aiɕoʔo* + *teas* ‘heartwood’ → *aiɕo teas* ‘heartwood of a casuarina tree’ and *naisoʔo* + *meʔe* ‘red’ → *naiso meʔe* ‘shallot’.

There are also a number of functors with final /a/ in the U-form which form their M-form by deletion of this vowel. These functors are given in (19) below.

These functors usually occur in the M-form and only take the U-form before consonant clusters or when the plural enclitic =*n* (§5.6) is attached.

(18) ...V₁Ca# / _CC → ...V₁C#

U-form		M-form	
<i>eta</i>	→	<i>et</i>	'IPFV.LOC; at, in, on'
<i>ofa</i>	→	<i>of</i>	'later, surely'
<i>fina</i>	→	<i>fin</i>	'because, so'
<i>tara</i>	→	<i>tar</i>	'until'
<i>n-aka</i>	→	<i>n-ak</i>	'say'

Finally, while most pronouns are VV# final and thus do not have distinct U-forms and M-forms, those pronouns which do have both forms have multiple U-forms; one with final /a/ and one with final /i/. These pronouns are given in (19) below.

(19) ...V₁CV₂# → ...V₁C#

U-form ₁		U-form ₂		M-form	
<i>ina</i>	→	<i>ini</i>	→	<i>iin</i>	's/he, it' 3SG.NOM
<i>sina</i>	→	<i>sini</i>	→	<i>siin</i>	'they' 3PL
= <i>sina</i>	→	= <i>sini</i>	→	= <i>siin</i>	'them' 3PL
<i>hita</i>	→	<i>hiti</i>	→	<i>hiit</i>	'we' 1PL.INCL.NOM
= <i>kita</i>	→	= <i>kiti</i>	→	= <i>kiit</i>	'us' 1PL.INCL.ACC

U-forms ending in /a/ are historically conservative. Thus, PMP **sida* > *sina* > *sini* 'they', and PMP **kita* > *hita* > *hiti* 'we', as well as **kita* > =*kita* > =*kiti* 'us'. The U-forms ending in /a/ tend only to be used before consonant clusters, while the other U-forms tend to be used with a morphological function, though there are counterexamples in both cases.

While at an abstract level of phonological organisation the M-form of these pronouns must be analysed as containing a vowel sequence, these pronouns are usually unstressed and, as a result, the vowel sequence is usually realised as a single short vowel. The vowel sequence in the M-form of these pronouns is usually only realised as phonetically long in certain environments, such as before vowel-initial enclitics (§6.4.1).

Comparative evidence that these pronouns have an underlying sequence of two vowels comes from Kusa-Manea in which M-forms of these pronouns have a /Va/ sequence: *ian* '3SG, s/he, it', *sian* '3PL, they', and *hiat* '1PL.INCL, we'.

4 Structure of metathesis

4.2.6 No change

Words which end in a vowel sequence do not have distinct U-forms and M-forms. Some examples are given in (20) below.

(20) $VV\# \rightarrow VV\#$

U-form		M-form	
<i>hau</i>	→	<i>hau</i>	‘tree, wood’
<i>pui</i>	→	<i>pui</i>	‘quail’
<i>biɕʒae</i>	→	<i>biɕʒae</i>	‘cow’
<i>meo</i>	→	<i>meo</i>	‘cat’
<i>ai</i>	→	<i>ai</i>	‘fire’
<i>kee</i>	→	<i>kee</i>	‘turtle, tortoise’
<i>pansoe</i>	→	<i>pansoe</i>	‘earthworm’
<i>?sao</i>	→	<i>?sao</i>	‘viper’

4.3 Unified analysis

A number of surface phonological operations occur to derive the M-form in Amarasi. Such phonological processes include metathesis, consonant deletion, and assimilation of /a/. Furthermore, metathesis itself can trigger further processes of consonant deletion, vowel deletion, and vowel height assimilation.

Table 4.8: Amarasi surface basic M-forms

U-form	M-form	U-form	M-form	processes
1. $V_1C_1V_2$	→ $V_1V_2C_1$	<i>fatu</i>	→ <i>faut</i>	‘pig’ metathesis
2. $V_1C_1V_2C_2$	→ $V_1V_2C_1$	<i>muʔit</i>	→ <i>muiʔ</i>	‘animal’ & C deletion
3. $V_{1HI}C_1V_{2MID}$	→ $V_1V_{2HI}C_1$	<i>ume</i>	→ <i>uim</i>	‘house’ & height ass.
4. $V_{1\alpha}C_1a(C_2)$	→ $V_{1\alpha}V_{\alpha}C_1$	<i>nima</i>	→ <i>niim</i>	‘five’ & /a/ ass.
5. $V_1V_2C_1V_3$	→ $V_1V_2C_1$	<i>aunu</i>	→ <i>aun</i>	‘spear’ V deletion
6. $V_1V_2C_1V_3C_2$	→ $V_1V_2C_1$	<i>nautus</i>	→ <i>naut</i>	‘beetle’ V deletion
7. $V_1V_2C_1$	→ V_1V_2	<i>kaut</i>	→ <i>kau</i>	‘papaya’ C deletion
8. V_1V_2	→ V_1V_2	<i>ai</i>	→ <i>ai</i>	‘fire’

Which operations apply to a word is determined by the phonotactic structure of that word, as well as the quality of the vowels it contains. The different structures of the M-form are summarised in Table 4.8. With the exception of M-forms with a double vowel (§3.2.1.4.1), all M-forms are phonetically disyllabic.

The M-form must be derived from the U-form as there is a large amount of ambiguity among M-forms. For instance, given an M-form with the shape VVC#, we cannot predict whether the U-form will have a shape corresponding to any of shapes 1–6 in Table 4.8. A concrete example is the form *n-neen*, which is the M-form of both *n-nene* ‘pushes’ and *n-nena* ‘hears’.

In this section I propose an analysis of all the different M-forms. I use an autosegmental model of phonology (Goldsmith 1976) and a rule-based model of process morphology (Matthews 1974; Anderson 1992). Adopting these models allows me to formulate a single, unified analysis of the diverse processes which occur in the formation of Amarasi M-forms. In §4.4 I discuss alternate analyses which I propose cannot account for all the Amarasi data.

My analysis consists of a single process of metathesis at the CV tier and an associated morphemically conditioned process (/a/ assimilation). These processes, combined with an obligatory CVCVC foot structure and the general phonotactic constraints of Amarasi, generate all the different M-forms.

In my autosegmental diagrams in the following sections empty C-slots are occasionally ‘filled’ with \emptyset in order to make it explicit that they behave identically to filled C-slots. This is a notational convenience. Similarly, the x-tier (or timing tier) is used as a notational device to illustrate clearly the effect of metathesis. Use of the x-tier should not be taken as a claim about its theoretical status.

4.3.1 Obligatory CVCVC Foot

I posit that the Amarasi foot obligatorily has the structure CVCVC and that C-slots may be empty. This stipulation is given in (21) below, and has already been discussed in §3.3.2. Extensive evidence for the existence of empty C-slots in Amarasi has been given in §3.3.7. This foot structure applies to all words

(21) Ft \rightarrow CVCVC

The structures of the words *fafi* ‘pig’, *mu?it* ‘animal’, *kaut* ‘papaya’, *ai* ‘fire’, *nautus* ‘beetle’ and *aunu* ‘spear’ under this analysis are given in (22)–(27) below. The initial C-slots of the words *ai* ‘fire’ and *aunu* ‘spear’ have been filled with an automatic glottal stop, as is the case for all vowel-initial words (§3.3.6).

(22) C V C V C
 | | | |
 f a f i

(23) C V C V C
 | | | |
 m u ? i t

(24) C V C V C
 | | | |
 k a u t

4 Structure of metathesis

- (25) $\begin{array}{ccccc} C & V & C & V & C \\ | & | & & | & \\ [?] & a & & i & \end{array}$ (26) $\begin{array}{ccccc} C & V & C & V & C \\ | & \wedge & | & | & \\ [?] & au & n & u & \end{array}$ (27) $\begin{array}{ccccc} C & V & C & V & C \\ | & \wedge & | & | & | \\ n & au & t & u & s \end{array}$

Metathesis at the CV tier yields a derived foot structure with the form CVVC. This structure is shown in (28)–(33) below.

- (28) $\begin{array}{cccc} C & V & V & C \\ | & | & | & | \\ f & a & i & f \end{array}$ (29) $\begin{array}{cccc} C & V & V & C \\ | & | & | & | \\ m & u & i & ? \end{array}$ (30) $\begin{array}{cccc} C & V & V & C \\ | & | & | & | \\ k & a & u & \end{array}$
- (31) $\begin{array}{cccc} C & V & V & C \\ | & | & | & | \\ [?] & a & i & \end{array}$ (32) $\begin{array}{cccc} C & V & V & C \\ | & | & | & | \\ [?] & a & u & n \end{array}$ (33) $\begin{array}{cccc} C & V & V & C \\ | & | & | & | \\ n & a & u & t \end{array}$

4.3.2 The morphological rule: metathesis

The process required to generate M-forms is metathesis, given in (34) below, which states that a C-slot and a V-slot metathesise after a stressed V-slot. This rule is a morphological process, in the style of Anderson (1992).

In (34) I have included the phonological environment in which metathesis takes place; after a stressed V-slot. This is *not* the environment which triggers metathesis but rather the environment by which metathesis is constrained.

- (34) $CV \rightarrow VC / \acute{V} _$

The operation of metathesis for the words *mu?it* ‘animal’, *kaut* ‘papaya’, and *fafi* ‘pig’ is given in (35) below. (35a) shows the underlying U-form of each of these words. In (35b) metathesis of the penultimate C-slot and final V-slot takes place. This results in a disallowed word-final cluster of two C-slots in (35c). To resolve this, the final C-slot is deleted in (35d), producing the M-forms in (35e).

- (35) a. $\begin{array}{cccccc} \times & \times & \times & \times & \times \\ | & | & | & | & | \\ C & V & C & V & C \# \\ | & | & | & | & | \\ m & u & ? & i & t \\ k & a & & u & t \\ f & a & f & i & \end{array}$ b. $\begin{array}{cccccc} \times & \times & \times & \times & \times \\ | & | & | & | & | \\ C & V & C & V & C \# \\ | & | & | & | & | \\ m & u & ? & i & t \\ k & a & & u & t \\ f & a & f & i & \end{array}$ c. $\begin{array}{cccccc} \times & \times & \times & \times & \times \\ | & | & | & | & | \\ C & V & V & C & C \# \\ | & | & | & | & | \\ m & u & i & ? & t \\ k & a & u & & t \\ f & a & i & f & \end{array}$

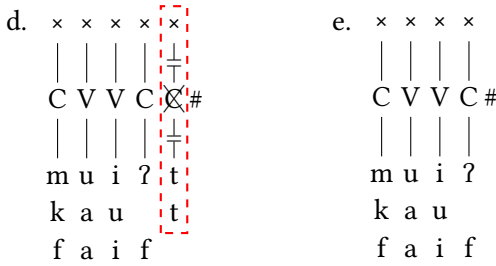

4.3.2.1 Metathesis and mid vowel assimilation

As discussed in §4.2.2.1, any final mid vowel assimilates to the height of a previous high vowel after metathesis. This vowel height assimilation is an instance of vowel harmony, arising from the fact that sequences of a high vowel and mid vowel are disallowed in Amarasi (§3.2.1.4).

This process is illustrated for *ume* → *uim* ‘house’ in (36) below. After metathesis in (36b), the feature [+HIGH] of the stressed vowel spreads in (36d) resulting in a sequence of two high vowels in (36e). Unless the [+HIGH] feature of the penultimate vowel is analysed as privative we would also have to propose that the height features [-HIGH, +MID] of the final vowel /e/ de-link in (36d).

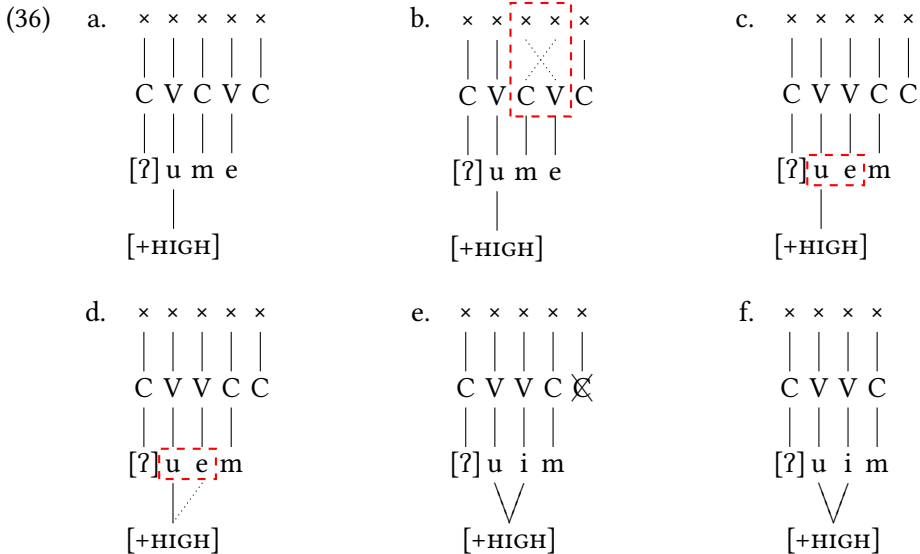

4 Structure of metathesis

4.3.2.2 Metathesis and vowel deletion

The vowel deletion in words with a phonetic diphthong, such as *nautus* [ˈnəwtʊs] → *nautus* [ˈnə.ʊt] ‘beetle’ results from metathesis and the fact that Amarasi does not allow sequences of three surface vowels. Recall from §3.3.4 that the first two vowels of words with a phonetic diphthong are associated to a single V-slot, as shown by the fact that stress falls on the antepenultimate vowel rather than the penultimate vowel.

The formation of the M-form for *nautus* [ˈnəwtʊs] → *nautus* [ˈnə.ʊt] ‘beetle’ is illustrated in (37) below. Metathesis in (37b) results in a surface sequence of three vowels in (37c); the first V-slot is associated to two vowels which are adjacent to another vowel associated to a single V-slot. As a result, the final vowel is deleted in (37d), with subsequent re-association of the adjacent vowel into the now empty V-slot in (37e). The final C-slot is also deleted yielding the output shown in (37f).

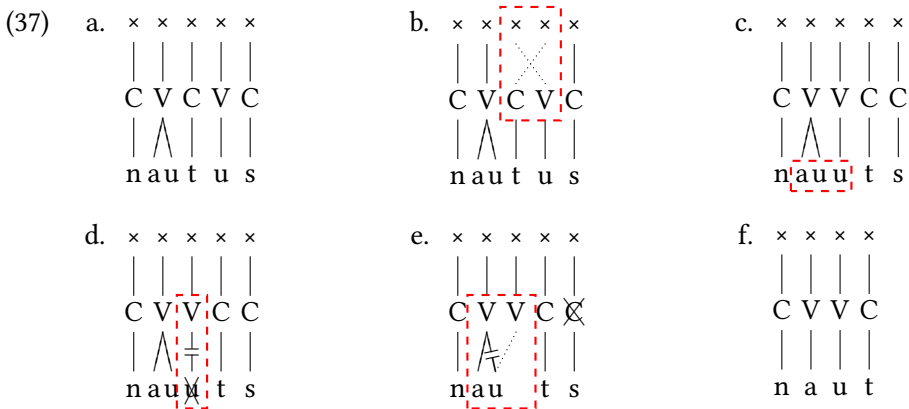

Evidence that it is the final vowel and not the penultimate vowel which is deleted comes from the word *n-aena* ‘runs, flees’ with the M-form *n-aen*. If the second vowel were deleted after metathesis in words with an initial phonetic diphthong, *n-aena* ‘runs, flees’ would have the M-form **n-aan*.

There are no other processes in Amarasi which create a sequence of three vowels within a morpheme. All other potential VVV sequences would occur across a morpheme boundary in which case consonants are inserted; a voiced obstruent morpheme finally (§3.3.7.2), and a glottal stop morpheme initially (§3.3.6).

4.3.3 The morphemically conditioned rule: assimilation of /a/

The morphological process of metathesis triggers assimilation of final /a/, such as in *nima* → *niim* ‘five’. This rule is given as rule (38) below. This rule states

4 Structure of metathesis

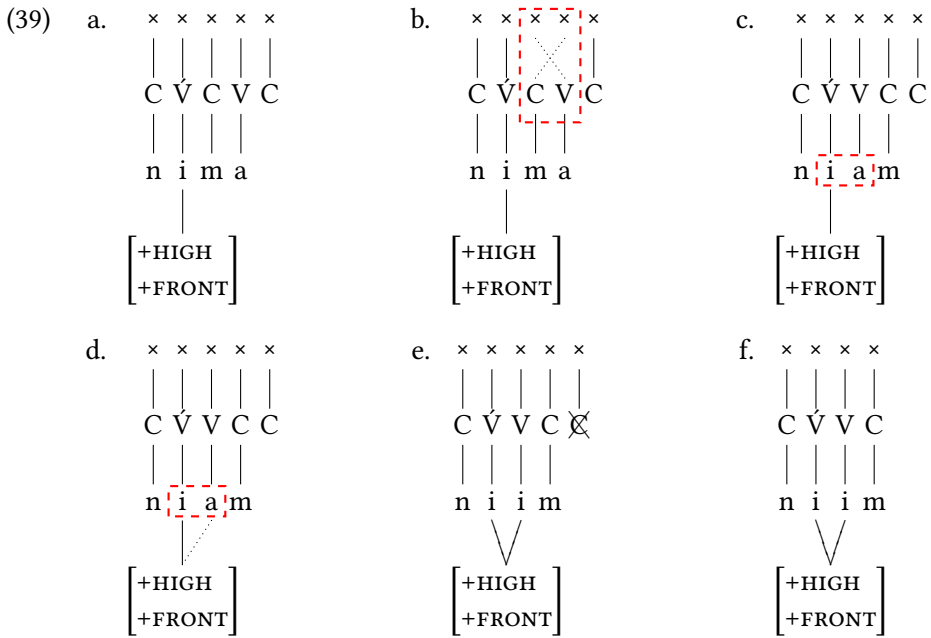

Under this analysis /a/ assimilation is triggered by the presence of two immediately adjacent V-slots; an environment which only occur in M-forms. The lack of assimilation in U-forms such as *kuan* ‘village’ is explained by the fact that there is an intervening C-slot between the two vowels; *ku_an*. The environment necessary for the operation of rule (38) is not present.

Assimilation of /a/ only occurs before filled C-slots. That is, it does not occur in the M-form of words such as *kuan* → *kua* ‘village’. I analyse the lack of assimilation in such forms as being due to the lack of a following filled C-slot.

The formation of *kuan* → *kua* ‘village’ is given in (40) below. Metathesis at the CV tier occurs in (40b), resulting in the V-slot to which /a/ is associated occurring directly after the stressed V-slot. However, the following C-slot is empty. This means the environment under which /a/ assimilation occurs is not present. Thus, no assimilation takes place. The final C-slot is then deleted in (40d)–(40e).

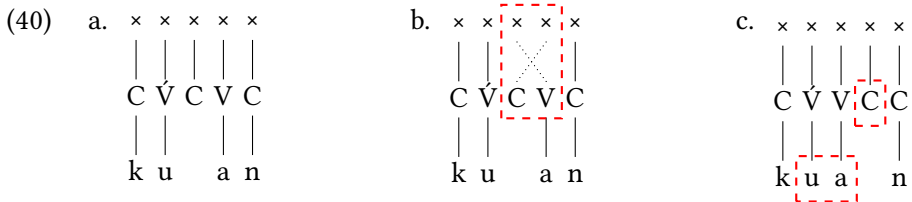

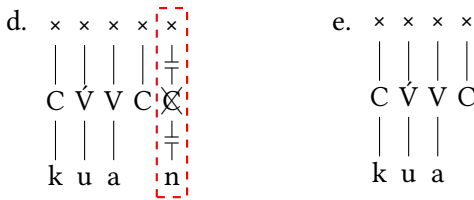

That /a/ is protected from assimilation by a following empty C-slot finds comparative support from Ro'is Amarasi. Ro'is Amarasi has a process whereby any final unstressed /a/ in a closed syllable (optionally) assimilates to the quality of the stressed vowel. Examples are given in Table 4.9.⁴

Table 4.9: Ro'is Amarasi post-stress /a/ assimilation

Kotos Amarasi	Ro'is Amarasi	
<i>?nima-f</i>	<i>nimi-f</i>	'arm, hand'
<i>sbeta-f</i>	<i>sbete-f</i>	'upper arm'
<i>ekam</i>	<i>erem, eram</i>	'pandanus'
<i>na-tenab</i>	<i>na-teneb</i>	'thinks'
<i>okam</i>	<i>okom, okam</i>	'melon, gourd'
<i>oras</i> [†]	<i>oros</i>	'time'
<i>ruman</i>	<i>rumun</i>	'empty'
<i>utan</i>	<i>utuk, utak</i>	'vegetables; pumpkin, squash' [‡]
<i>surat</i> [#]	<i>surut</i>	'paper, book'

[†] From Portuguese *horas* [ɔras] 'hours'.

[‡] Kotos Amarasi *utan* means only 'vegetables'.

[#] From Malay *surat* 'letter'.

Assimilation of /a/ in closed syllables in Ro'is is productive, as seen by forms such as Ro'is *ina?* 'mother' and *maun ini-f* 'hen', as well as borrowings such as Portuguese *horas* [ɔras] → Ro'is *oros*. However, such assimilation does not occur in final open syllables of a stem, even those which are followed by a consonant. Two examples are Ro'is *bo?*=*esa* =*m hiut* 'seventeen' and *n-oka skoor* 'with a school'. This lack of assimilation can be explained by the same mechanism which blocks assimilation of /a/ in M-forms: a following empty C-slot.

⁴Assimilation of /a/ in Ro'is Amarasi does not usually occur before or after the glottal stop: i.e. *ke?an* 'room' and *ina?* 'mother'. Assimilation of /a/ in closed final syllables also occurs in Timaus and the variety of Meto spoken in the village of Oepaha – both adjacent to Ro'is Amarasi speaking areas.

4 Structure of metathesis

The reason assimilation of /a/ does not occur in Kotos Amarasi in the derivation of an M-form from a VVC# final root can also be accounted for due to the difficulty of recovering the U-form based on the M-form if assimilation took place. In a stem such as *nima* → *niim* ‘five’ the majority of its segments are preserved in the M-form with three out of four segments retained. Similarly, a stem such *ri-nah* → *riin* ‘pomegranate, wood apple’ also preserves most of its segments with the M-form attesting three out of five segments of the U-form. However, in a hypothetical case such as *kuan* → **kuu* ‘village’ only two out of four segments would be preserved after metathesis.⁵

Finally, as discussed in §4.2.2.2, in Ro’is Amarasi /a/ does not assimilate when the metathesising consonant is a glottal stop, as seen in Ro’is *n-roʔa* → *n-roaʔ* ‘vomit’ which contrasts with Kotos *n-roʔa* → *n-rooʔ* ‘vomit’. No matter how this is explained, it does provide evidence that the kind of consonant in the C-slot which moves after metathesis plays a role in /a/ assimilation. In Kotos Amarasi only an unfilled final C-slot protects /a/ from undergoing assimilation after metathesis, while in Ro’is Amarasi this is extended to final C-slots which are filled by glottal stop – the minimal consonant.

4.3.4 Summary

In this section I have proposed a single unified analysis of the formation of the M-form from the U-form in Amarasi. This analysis is framed under an autosegmental model of phonology (Goldsmith 1976) and a rule-based model of process morphology (Matthews 1974; Anderson 1992). My analysis consists of three parts: one phonological stipulation, one morphological rule, and one morphemically conditioned rule. The phonological stipulation and the rules are repeated in (41)–(43) below.

(41) Ft → CVCVC

(42) CV → VC /V́_

(43) $\begin{array}{ccc} \acute{V} & V & C \\ | & | & | \\ & & a \\ & & \vdots \\ & & [+F.] \end{array}$

⁵M-forms such as *mainuan* → *mainua* ‘openness’ which also do not undergo assimilation of final /a/ show that the final foot, not the stem, is the relevant domain which determines whether enough segments are preserved after metathesis.

These two rules and single stipulation, combined with the general phonotactic constraints of Amarasi, are sufficient to account for formation of the M-forms. The general phonotactic constraints of Amarasi with which these rules interact are given below:

- clusters of two C-slots are prohibited word finally
- sequences of three surface vowels are prohibited
- vowel sequences consisting of a high-vowel and mid-vowel are prohibited

This rule-based analysis of Amarasi accounts for all of the data in a single consistent way. In the next section I consider some alternate analyses. While these analyses can account for some of the data Amarasi data they cannot account for all of the data.

4.4 Alternate approaches

In the final part of this chapter I consider the ways alternate approaches would handle the Amarasi data. There are no existing proposals in the literature which can adequately handle all of the Amarasi data.

In §4.4.1 I consider whether an approach framed within prosodic morphology (McCarthy & Prince 1990; 1993b) can explain the Amarasi data. In particular, I consider whether the analysis of McCarthy (2000) for Rotuman metathesis or that of Heinz (2004) for Kwara'ae can be extended to Amarasi. While such analyses can explain a small amount of the Amarasi data, they cannot explain it all. Furthermore, because there is no consistent single prosodic structure present in Amarasi surface M-forms, an analysis framed within prosodic morphology does not seem appropriate,

In §4.4.2 I show that Amarasi metathesis cannot be analysed as phonologically conditioned as has been proposed for Rotuman (Hale & Kissonock 1998; McCarthy 2000), Kwara'ae (Heinz 2004), and Luang (Taber & Taber 2015), as well as Meto (McConvell & Kolo 1996).

Finally, in §4.4.3 I show that it is typologically implausible to analyse the Amarasi data as a fundamentally concatenative process involving affixation of a CV melody to the segmental information of a word.

4.4.1 Prosodic morphology

One alternate approach to the data would be to analyse Amarasi metathesis within the framework of prosodic morphology. Such an analysis has been proposed by McCarthy (2000) for Rotuman metathesis. Similarly, Heinz (2004) proposes an analysis of synchronic metathesis in Kwara'ae which is compatible with a prosodic morphological approach. After a discussion of each of these analyses, I show that neither can be adapted and/or extended to the Amarasi data.

4.4.1.1 Rotuman

The forms and functions of metathesis in Rotuman has been comprehensively summarised in §2.3.2. As discussed in §2.3.2, a variety of different processes are used to form the M-form from the U-form. These processes include vowel deletion, metathesis, umlaut, and diphthongisation. Which process applies depends on the quality of the penultimate and final vowels of the U-form, as well as whether the U-form is VCV# final or VV# final. There are also a certain number of word shapes with no distinction between the two forms. Examples of each of these processes extracted from Churchward (1940) are given in Table 4.10 in standard IPA transcription.

Table 4.10: Rotuman U-form and M-form alternations

Process	U-form	M-form	gloss
deletion	<i>haŋa</i>	<i>haŋ</i>	'feed'
	<i>tokiri</i>	<i>tokir</i>	'roll'
metathesis	<i>pure</i>	<i>puer</i>	'rule, decide'
	<i>hoʔa</i>	<i>hoaʔ</i>	'take'
umlaut	<i>mori</i>	<i>mør</i>	'orange (fruit)'
	<i>ʔuli</i>	<i>ʔyl</i>	'skin'
diphthongisation	<i>pupui</i>	<i>pupüi</i>	'floor'
	<i>foʔou</i>	<i>foʔöu</i>	'new'
no change	<i>rii</i>	<i>rii</i>	'house'
	<i>ree</i>	<i>ree</i>	'do'

An analysis of the Rotuman data within the framework of prosodic morphology and Optimality Theory (Prince & Smolensky 1993/2002) is presented in McCarthy (2000). McCarthy (2000: 159) bases his analysis on the observation that

“The incomplete phase [M-form] is identical to the complete phase [U-form], except that the *final foot* of the complete phase is realized as a *monosyllabic foot* in the incomplete phase.” Regarding words which form the M-form via metathesis, such as *hoʔa* → *hoaʔ* ‘take’, McCarthy (2000) argues that the M-form consists of a single syllable, as is consistent with more recent descriptions of Rotuman including Besnier (1987) and Vamarasi (2002).⁶

Under McCarthy’s analysis Rotuman is a weight sensitive language. Because a (metathesised) monosyllable such as *hoaʔ* ‘take’ is consonant final, it has two morae and bears stress as expected for a heavy syllable in a weight sensitive language.

McCarthy (2000) also draws upon the observation by Hale & Kissonck (1998) that in most cases the use of the two stems in Rotuman is conditioned by the number of syllables of a following suffix or enclitic. Suffixes and enclitics consisting of two or more syllables trigger the U-form, while monosyllabic or non-syllabic suffixes and enclitics occur with a stem in the M-form.⁷

McCarthy (2000: 156) then draws upon the principle of Foot Binarity, whereby feet are required to consist of a minimum of either two syllables or two morae. McCarthy proposes that polysyllabic suffixes and enclitics are prosodically external to the stem, as they are eligible to form independent feet. Non-syllabic and monosyllabic suffixes, on the other hand cannot form feet and are thus bound to the stem.

McCarthy (2000: 163) represents forms like *hoaʔ-kia* ‘take-TRANSITIVE’ with the structure in (44). The stem of this form is in the M-form (a heavy syllable consisting of two morae) with a polysyllabic suffix/enclitic attached. McCarthy represents forms like *hoʔa-ŋe* ‘take-away’ with the structure in (45). The stem of this form is in the U-form (a disyllable) with a monosyllabic suffix. In both these diagrams ‘PrWd’ stands for ‘prosodic word’.⁸

⁶ It not certain that the M-form was monosyllabic when Churchward conducted his fieldwork Churchward (1940: 86) states that “the stress seems to be levelled out, so to speak, in the inc[omplete] phase [M-form]. Thus: *foa* becomes *foar*, which is pronounced almost, though perhaps not quite, as one syllable, the stress being evenly distributed ...” While McCarthy (2000) takes this statement to suggest the M-form is a monosyllabic word, it can also be taken to mean that the M-form is shorter in phonetic length even though it remains two syllables.

⁷ As noted by McCarthy (2000: 162), Hale & Kissonck (1998) identify two zero suffixes which occur with the U-form and one monosyllabic suffix which occurs with the M-form. McCarthy (2000) does not offer any explanation for their aberrant behaviour beyond mentioning that Hale & Kissonck (1998) analysed such forms as taking zero suffixes which bear moraic weight.

⁸ McCarthy (2000) uses different examples to illustrate the prosodic structures of the U-form and M-form of words. I have selected these examples in order to illustrate clearly the difference between metathesised and unmetathesised forms.

4 Structure of metathesis

(44) M-form and long suffix:

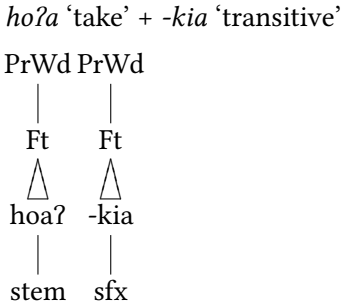

(45) U-form and short suffix:

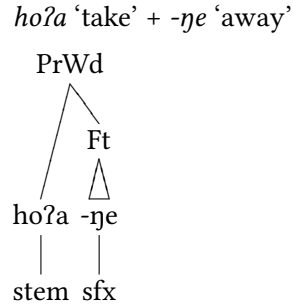

The constraint ALIGN-HEAD- σ , which requires stressed syllables to be word final, is crucial in McCarthy’s analysis. This constraint regulates prosodic words. When a stem occurs with a long suffix, each prosodic word occurs in the M-form. This means that both the stem and the suffix/enclitic in (44) would occur in the M-form. When a stem occurs with a short suffix the whole prosodic word, – the stem combined with the suffix/enclitic – would occur in the M-form.

For Rotuman, the constraint ALIGN-HEAD- σ and the constraint MAX (prohibiting deletion) are ranked more highly than the constraint LINEARITY (prohibiting metathesis). Each of these three constraints is given in (46) below.

(46) Constraint Ranking in McCarthy (2000):

- a. ALIGN-HEAD- σ : Align(H’(PrWd), R, PrWd, R) (The main-stressed syllable is final in every prosodic word)
- b. MAX: Every element of S_1 has a correspondent in S_2 (No deletion)
- c. LINEARITY: S_1 is consistent with the precedence structure of S_2 and vice versa (No metathesis)

Metathesis results as it is “the most faithful constraint mapping of a /...VCV/ input that still satisfies ALIGN-HEAD- σ .” McCarthy (2000: 174) gives an equivalent of the optimality tableau in (47) below.

(47)

Input: /hoʔ ₁ a ₂ /	ALIGN-HEAD- σ	MAX	LINEARITY
a. hoa ₂ ʔ ₁			*
b. hoʔ ₁		*!	
c. hoʔ ₁ a ₂	*!		

Under McCarthy’s analysis Rotuman metathesis (along with other processes which form the M-form) occurs in order to create final stressed syllables within

the domain of the prosodic word. I refer the reader to McCarthy (2000) for a full analysis of the different phonological processes in Rotuman and the ways in which these are handled.

4.4.1.2 Kwara'ae

The forms and functions of metathesis in Kwara'ae are summarised in §2.3.1. In Kwara'ae the metathesised form of words is the form of words used in everyday normal speech while the unmetathesised form is used in traditional songs, for clarification, and when calling/yelling out. Some examples of metathesis in Kwara'ae are given in (48) below.

(48) Metathesis in Kwara'ae (Heinz 2004)

U-form		M-form	
'lo.ʔi	→	'loɪʔ	'snake'
'bu.ri	→	'buiɾ	'behind'
'bo.re	→	'boɾeɾ	'although'
'ki.ni	→	'ki.n	'woman'
'de.ŋe	→	'de.ŋ	'shrimp'
'ke.ta, la.ku	→	'keɾat, lauk	'my height'
da.'ro.ʔa, ni.da	→	'daoɾ.ʔa, niɛd	'to share them'

According to the description in Heinz (2004), each Kwara'ae unmetathesised form contains one or more stressed syllables with a single vowel which are followed by an unstressed vowel. Each metathesised form contains stressed syllables, each of which is a heavy syllable containing either a vowel and glide or a long vowel.

Based on this observation Heinz (2004) analyses metathesis in Kwara'ae as being conditioned by the placement of stress. His analysis is framed under Optimality Theory and is based on ranking the Stress to Weight Principle constraint (requiring stressed syllables to be heavy) more highly than the constraint of Linearity, which requires segments to occur in their underlying order. Given an underlying form such as /salɔ/ 'sky', the metathesised form with a heavy syllable consisting of a vowel and glide is selected rather than the unmetathesised form with two light syllables, as shown in the optimality tableau in (49) below

(49) Metathesis in Kwara'ae Heinz (2004: 53)

Input: /salɔ/	SWP	LINEARITY
a. 'saɔl		*
b. 'sa.lo	*!	

4 Structure of metathesis

4.4.1.3 Amarasi

Although the analysis of McCarthy (2000) for Rotuman and the analysis of Heinz (2004) for Kwara'ae are different in several details, in each case metathesis is analysed as occurring in order to create a monosyllabic form which bears stress. Whatever the merits these analyses may have for Rotuman or Kwara'ae, they cannot be extended to describe the Amarasi data. This is because in most cases the stress and number of syllables of a U-form and M-form are identical.

This is true of forms with different penultimate and final vowels which undergo metathesis; such as *hitu* ['hi.tʊ] → *hiut* ['hi.ʊt] 'seven'. It is true of words which undergo metathesis and deletion of a final consonant; *muʔit* ['mʊ.ʔit] → *muiʔ* ['mʊ.iʔ] 'animal'. It is also true of words which undergo deletion of a final consonant such as *kuan* ['kʊ.ɐn] → *kua* ['kʊ.ɐ] 'village'.⁹

The only cases in which such an analysis could be successfully applied are those in which the M-form is, arguably, a reduced form. This includes words in which the penultimate and final vowel are identical, such as *fini* ['fi.ni] → *fin* ['fi:n] 'seed', or those in which assimilation of /a/ occurs, such as *nima* ['ni.mə] → *nim* ['ni:m] 'five'. It also perhaps includes words with an initial phonetic diphthong, such as *nautus* ['nəw.tʊs] → *naut* ['nə.ʊt] 'beetle'.

In cases in which the M-form has a final sequence of two identical vowels, such as *fini* ['fi.ni] → *fin* ['fi:n] 'seed', there is a reduction in the number of phonetic syllables, with a resultant change in stress from a light syllable to a heavy syllable. In such instances alone an analysis along the lines of McCarthy (2000) or Heinz (2004) in which metathesis occurs to create a heavy stressed syllable could be proposed. However, given the evidence for treating phonetically long vowels as a sequence of two identical vowels (§3.2.1.4.1), and the fact that Amarasi is otherwise not a weight sensitive language (§3.3.4), this analysis is not consistent with other facts of the language.

Not only does such an analysis contradict other facts of Amarasi, but it also cannot account for all the data, as the M-form of words such as *hitu* ['hi.tʊ] → *hiut* ['hi.ʊt] 'seven' simply do not contain a stressed heavy syllable. Therefore, neither of the analyses proposed by McCarthy (2000) or Heinz (2004) can explain all the Amarasi data. Furthermore, it is not at all clear that *any* analysis framed within prosodic morphology could account for the Amarasi data.

One approach, broadly in line with the notion that consonant-vowel metathesis is a reduction strategy, would be to propose that the M-forms occur in order

⁹It is also worth noting that while words which end in VV#, such as *ai* [ʔa.i] 'fire', do not have distinct M-forms and U-forms in Amarasi, the prosodic structure of such a word is identical when it occurs in either a U-form or M-form environment.

to create a phonetically shorter form. An M-form with a vowel sequence such as *hiut* [hi.ʊt̚] ‘seven’ is usually, though not always, phonetically shorter than the U-form *hitu* [hiʔʊ] in which the two vowels are separated by a consonant.¹⁰ Apart from the fact that the phonetic length of a word in Amarasi is primarily determined by speech speed, sentence stress, and pragmatics rather than the phonotactic shape of a word, this approach would leave unexplained forms in which the U-form and M-form both have a vowel sequence, such as *kuan* [kʊ.ɛn] → *kua* [kʊ.ɐ] ‘village’.

Another possibility would be to propose M-forms occur in order to create consonant-final forms. Such a proposal does not explain why VVC# U-forms such as *kuan* [kʊ.ɛn] → *kua* [kʊ.ɐ] ‘village’ delete their final consonant to form an M-form, nor why already consonant-final U-forms such as [mʊ.ʔit̚] → *mui?* [mʊ.iʔ] ‘animal’ undergo metathesis in the M-form.

The diversity in the surface prosodic structures of M-forms in Amarasi confounds an analysis framed within prosodic morphology. While in Rotuman there is a comparable diversity in forms, nearly all instances of the M-form have been analysed as bi-moraic monosyllables, thus an analysis framed within prosodic morphology is successful.

A prosodic morphology approach to the Amarasi data encounters serious challenges which cannot obviously be overcome. Instead, by adopting a process based model of morphology and an obligatory CVCVC foot structure for U-forms, the different processes in the formation of the Amarasi M-form can be explained with a single process of metathesis and a single morphemically conditioned rule of /a/ assimilation. This analysis accounts for Amarasi M-forms in a simple, consistent, unified way.

Finally, regarding Optimality Theory, which is utilised in the analyses of McCarthy (2000) and Heinz (2004), the high level of opacity/ambiguity in the derivation of M-forms — including at least one derived environment effect (§4.2.2.2) —

¹⁰That the total length of a vowel sequence is usually shorter than the combined length of two vowels separated by a consonant is confirmed by an instrumental phonetic study. I marked vowels in Praat in three recorded texts from a single speaker and extracted their lengths with a script. (Words with a distinctive pause intonation were discarded.) This resulted in 255 measurements of both the vowels in forms such as *hitu* ‘seven’ (that is, the measurements of 510 vowels with the length of the penultimate and final vowels summed) and 243 lengths of vowel sequences in M-forms such as *hiut* ‘seven’. The average length of two vowels separated by a consonant was 0.17 seconds and the average length of a vowel sequence was 0.13 seconds. A two tailed t-test showed that this difference was statistically significant ($p > 0.001$). The lengths of 385 vowel sequences in U-forms such as *kuan* ‘village’ were also extracted and had an average duration of 0.12 seconds. A two tailed t-test showed that the difference between vowel sequences in M-forms and U-forms is probably not statistically significant ($p = 0.11$).

indicates that standard Optimality Theory would not fare particularly well in Amarasi. This is one of the reasons I have not employed it in this book.

4.4.2 Phonologically conditioned metathesis

Another possible approach to the Amarasi data would be to analyse metathesis as phonologically conditioned. This is, in fact, part of the analysis of Rotuman given by McCarthy (2000: 168) who explicitly rejects the idea that there is a metathesis morpheme and states: “[...] earlier accounts of the phase [U-form/M-form] difference are inadequate empirically, since it does not make sense to talk of a phase morpheme or template.”¹¹

Another language with synchronic consonant-vowel metathesis which has been analysed as phonologically conditioned is Luang in the Timor region (Taber & Taber 2015). For Luang, Taber & Taber (2015: 24) propose that metathesis is one of several phonological processes which operates to join adjacent words into a single rhythm unit with only one stressed syllable.

Whatever the case may be for Rotuman or Luang, metathesis in Amarasi cannot be reduced to a phonologically conditioned process. As discussed in Chapters 6 and 7, metathesis in Amarasi is the only phonological marking of certain syntactic and/or discourse structures.

Amarasi nouns followed by cardinal and ordinal numerals provide the clearest demonstration that Amarasi metathesis is not phonologically conditioned. When followed by a cardinal number, nouns occur in the U-form. However, when followed by an ordinal number, nouns occur in the M-form. Examples are given in Table 4.11, which shows the noun *nenō* ‘day’ followed by cardinal and ordinal numbers.¹²

There is no phonetic difference between each kind of phrase, with the exception of the metathesis of the noun and, where applicable, the addition of the glottal stop forming ordinal numbers. In every phrase the noun has two syllables and stress falls on the penultimate vowel of the numeral. Compare especially the phrase *nenō mese?* ‘a single day’ with that of *neon mese?* ‘first day (Monday)’, in which the only difference is in the metathesis of the noun.

¹¹That McCarthy (2000) explicitly rejects the notion of a “phase morpheme” is surprising given that Churchward (1940) gives many examples in which the use of the U-form or M-form is the only marker of a semantic difference, as summarised in §2.3.2.2. McCarthy (2000) does not offer any analysis of such uses of the U-form and M-form.

¹²The ordinal numbers in 4.11 are those used for counting days and months, and are derived from the cardinal numbers with the addition of a glottal stop as a suffix or infix.

Table 4.11: Amarasi nouns and numerals

Underlying	Phonetic		gloss
<i>nenō meseʔ</i>	[,nɛnɔ'mɛsɛʔ]	◀▶	'a single day' [†]
<i>neon meseʔ</i>	[,nɛ.ɔn'mɛsɛʔ]	◀▶	'first day (Monday)' [‡]
<i>nenō nua</i>	[,nɛnɔ'nʊ.ɐ]	◀▶	'two days'
<i>neon nua-ʔ</i>	[,nɛ.ɔ'n:ʊ.ɐʔ]	◀▶	'second day (Tuesday)'
<i>nenō teun[#]</i>	[,nɛnɔ'tɛ.ʊn]	◀▶	'three days'
<i>neon tenu-ʔ</i>	[,nɛ.ɔn'tɛnʊʔ]	◀▶	'third day (Wednesday)'
<i>nenō haa</i>	[,nɛnɔ'ha:]	◀▶	'four days'
<i>neon haa-ʔ</i>	[,nɛ.ɔn'haʔ]	◀▶	'fourth day (Thursday)'
<i>nenō niim</i>	[,nɛnɔ'ni:m]	◀▶	'five days'
<i>neon nima-ʔ</i>	[,nɛ.ɔ'n:i:mɐʔ]	◀▶	'fifth day (Friday)'
<i>nenō nee</i>	[,nɛnɔ'ne:]	◀▶	'six days'
<i>neon ne<ʔ>e</i>	[,nɛ.ɔ'n:ɛʔɛ]	◀▶	'sixth day (Saturday)'

[†] The phrase *nenō meseʔ* has the sense of 'a single day'. The normal phrase for 'one day' would be *neengw=ees*, from *nenō* + *=ees*.

[‡] The normal reference for the phrases with ordinal numbers is to the days of the week, with *neon meseʔ* 'first day' being Monday and *neon ne<ʔ>e* 'sixth day' being Saturday. The normal phrase for Sunday is *nenō krei* 'day + church'. The phrase *neon hitu-ʔ* 'seventh day' is attested twice in the Amarasi Bible translation in Genesis 2. This shows that the phrases with ordinal numbers are not just completely lexicalised phrases.

[#] The default form for cardinal numerals is the M-form.

Instead, the M-form marks that these phrases have different syntactic structures. Ordinal numbers occur within the noun phrase while cardinal numbers occur outside of the noun phrase as the head of a number phrase. The different syntactic structures of the phrases *nenō meseʔ* and *neon meseʔ* are shown in (50) and (51) below. See Chapter 6, especially §6.3.5, for full details.

- | | |
|--|--|
| <p>(50) [,nɛnɔ 'mɛsɛʔ
 [_{NP} nenō] [_{Num} meseʔ]
 day\U one\U
 'a single day'</p> | <p>(51) [,nɛ.ɔn 'mɛsɛʔ
 [_{NP} neon meseʔ]
 day\M one\U
 'first day (i.e. Monday)'</p> |
|--|--|

Such data rule out an analysis of Amarasi metathesis as phonologically conditioned, unless we posit that different syntactic structures are associated with different abstract phonological structures with no phonological realisation.

4 Structure of metathesis

4.4.2.1 Metathesis conditioned by intonation

Based on preliminary data on a north-eastern variety of Meto, McConvell & Kolo (1996) raise the possibility that metathesis in Meto could be prosodically conditioned.¹³ They noted that they had two examples of a U-form verb with falling or low pitch, and two examples of an M-form verb with rising or high pitch.

To test the hypothesis that metathesis in Amarasi could be conditioned by intonation, I took a random selection of 80 U-form verbs and 80 M-form verbs in different sentence positions from a number of natural texts. The pitch of each verb was recorded as either rise, fall, high, mid, or low. The results are summarised in Table 4.12.

Table 4.12: Verbal metathesis and intonation

	U-form	M-form
rise	10	9
high	14	15
mid	14	5
low	2	10
fall	40	41

Table 4.12 shows that the pitch of both U-form and M-form verbs is very similar. About half of both U-forms and M-forms have a falling pitch and about a quarter have a rising or high pitch. The only difference is in the frequency of mid pitch and low pitch, with M-forms occurring with a low pitch more frequently than U-forms – the opposite to what would be predicted by McConvell & Kolo’s preliminary hypothesis.

4.4.3 Affixation of consonant-vowel melody

A final possible analysis of Amarasi metathesis would be to analyse it under an item and arrangement model of morphology in which the consonant-vowel template itself is a kind of affix which combines with to the segments of a word. This is the analysis proposed by Stonham (1994: 160f) for Rotuman metathesis and would be similar to the analysis of Arabic morphology in McCarthy (1981).

¹³Thanks go to Patrick McConvell for providing me with his unpublished notes. Based on this material, the variety described appears to be Miomafo, Insana, or Biboki.

Under such an analysis, each consonant of an Amarasi word would be ordered with respect to each other consonant and each vowel would be ordered with respect to each other vowel, but consonants and vowels would not be ordered with respect to one another. An Amarasi word such as *fatu* ~ *faut* ‘stone’ could then be represented as either /ft,au/ or /au,ft/. This segmental information then combines with the appropriate consonant-vowel melody. This is shown in (52) below which makes explicit the concatenative nature of this analysis, and in (53) with autosegmental notation. Examples (52a) and (53a) show U-forms and examples (52b) and (53b) show M-forms.

(52) a. /ft,au/ + CVCV → *fatu*

b. /ft,au/ + CVVC → *faut*

(53) a.
$$\begin{array}{cccc} f & & t & \\ | & & | & \\ C & V & C & V \\ | & & | & \\ a & & u & \end{array}$$

b.
$$\begin{array}{cccc} f & & & t \\ | & & & | \\ C & V & V & C \\ | & & | & \\ a & & u & \end{array}$$

Analysing Amarasi metathesis as affixation with different consonant-vowel melodies is possible. Under such an analysis, the selection of the appropriate melody would be determined by morphosyntactic criteria. While a concatenative analysis accurately describes the data, there are two ways in which the process-based analysis adopted in this chapter better fits the Amarasi data.

Firstly, the affixal analysis misses the generalisation that the M-form is always derivable from the U-form by reversal of the final CV sequence. While morphological consonant-vowel metathesis is rare, it is cross-linguistically attested (see Chapter 2). Under the concatenative analysis it is not immediately clear why the derived M-form does not involve other kinds of metathesis, or other arbitrary substitutions. Under the concatenative analysis there is no principled reason that the M-form should not be, for instance, VCVV yielding *fatu* ‘stone’ → **afuu*.

Secondly – and closely linked to the first reason – the affixal approach to metathesis misses the cross-linguistic generalisation discussed in §2.4.2 and §2.5 that processes of compensatory metathesis (see further §4.5 below) are located adjacent to a stressed syllable. The placement of stress plays no role in the derivation of M-forms under the affixal analysis. The rule based approach, on the other hand, achieves this straightforwardly by including the stressed syllable as the constraining environment after which metathesis occurs.

4.5 Origins of Amarasi metathesis

As discussed in §2.4.2, Blevins & Garrett (1998; 2004) propose a number of ways in which a language can acquire a synchronic process of metathesis through a number of phonetically natural steps. Under their account the kind of metathesis seen in Amarasi is compensatory metathesis, which arose originally in certain prosodically conditioned environments:

“Compensatory metatheses originate when VCV sequences are pronounced with extreme coarticulation of one vowel, resulting in a seepage or shift of that vowel to the other side of the medial consonant. This extreme form of coarticulation occurs in syllables which are already long due to stress. The peripheral unstressed vowel, whose cues are now primarily on the opposite side of the consonant, withers into a reduced form, and is ultimately lost. The migration of the peripheral vowel across the intervening consonant into tonic position is complete.” (Blevins & Garrett 1998: 529)

Under this account a noun such as *fatu* ‘stone’ goes through a process like that illustrated in (54) below. This process would only occur in certain prosodic environments, with the end result that the forms *fatu* and *faut* are found in different phonological environments.

(54) *fatu* > **fautu* > **fautũ* > *faut*

In Kotos Amarasi only the first stage (*fatu*) and the final stage (*faut*) are attested. If this is indeed the process that gave rise to metathesis in Amarasi, we would expect to find data attesting the hypothesised medial stages. Indeed, data from other varieties of Meto attests these stages.

4.5.1 First intermediate stage

Intermediate stages with an initial diphthong and final full vowel (i.e. **fautu*) are found in Ro’is Amarasi. As discussed in §3.4.1.2, in Ro’is the U-form of certain consonant final roots show spread of the final vowel to the first syllable. The examples from page 138 are repeated in Table 4.13, which shows Kotos Amarasi U-forms, Ro’is Amarasi U-forms and M-forms before enclitics (Chapter 5).

This diphthongisation is productive and, as discussed in §4.6.3, either this diphthongisation or complete metathesis occurs in Ro’is Amarasi before modifiers which begin with a consonant cluster. Thus, the complete process of compensatory metathesis as hypothesised by Blevins & Garrett (1998) is attested in a

Table 4.13: Ro'is Amarasi diphthongisation

Kotos U-form	Ro'is U-form	Kotos/Ro'is M̄-form	gloss
<i>tefis</i>	<i>tēf̄ik</i>	<i>teifs/k=</i>	'roof'
<i>masik</i>	<i>māisik</i>	<i>maisk=</i>	'salt'
<i>toʔis</i>	<i>tōʔis</i>	<i>toiʔs=</i>	'trumpet'
<i>hunik</i>	<i>hūnik</i>	<i>huink=</i>	'turmeric'
<i>anet</i>	<i>āenet</i>	<i>aent=</i>	'needle'
<i>rone-f</i>	<i>rōene-f</i>	<i>roen-f=</i>	'brain'
<i>niis eno-f</i>	<i>niis ēono-f</i>	<i>niis eon-f=</i>	'incisors'
<i>n-ʔator</i>	<i>n-ʔāotor</i>	<i>n-ʔaotr=</i>	'arrange'
<i>siʔu-f</i>	<i>sūʔu-f</i>	<i>siuʔ-f=</i>	'elbow'
<i>esuk</i>	<i>ēusuk</i>	<i>eusk=</i>	'mortar'
<i>manus</i>	<i>māunus</i>	<i>mauns=</i>	'beetle vine'
<i>ponu-f</i>	<i>pōunu-f</i>	<i>poun-f=</i>	'moustache' [†]

[†] Kotos *ponu-f* is 'moustache' and Ro'is *pōunu-f* is 'body hair'.

phrase such as *umi* 'house' + *kbubuʔ* 'round'. Kotos Amarasi *umi kbubuʔ* attests the first stage, while Ro'is Amarasi *ūmi kbubuʔ* and *uim kbubuʔ* attest the intermediate and final stages.

Additionally, there is one instance in which diphthongisation is attested before a modifier with a single consonant in my corpus of Ro'is Amarasi texts. This is the phrase *rasi* 'matter' + *matsao-s* 'marriage' which occurs as *rāsi matsaos* 'marriage arrangements' four times in one of my Ro'is texts. One of these examples is given in (55) below.

- (55) *ɕzadi na-ʔuabaʔ rāsi matsao-s=iidɕ=ii*
ɕzadi na-ʔuabaʔ rasi matsao-s=ii=ii
 so 3-speak matter marry-NML=1DET=TOP
 'So they talk about the marriage arrangements' RO-170830-1, 6.54 

Ro'is Amarasi attests spread of the final vowel to the penultimate position creating a medial diphthong. This is the first intermediate stage which can give rise to synchronic metathesis.

4.5.2 Second intermediate stage

The second intermediate stage showing forms with a reduced final vowel (i.e. *fautü), is found in some varieties of South Amanuban, Timaus, Fatule'u, Amfo'an and Kopas. My discussion here focusses on the variety of South Amanuban spoken in Se'i village.¹⁴

In Se'i Amanuban verbs and numerals are usually cited in a form with a medial double vowel corresponding to the penultimate vowel of the root and a final non-syllabic or voiceless vowel corresponding to the root final vowel. A simple example is *tenu* → *teñu* 'three'. More examples are given in Table 4.14 on the next page. Such words also have metathesised forms, such as *tenu* → *teun* 'three'. The only words in my Se'i Amanuban data which do not have forms with a final non-syllabic vowel are those with final /a/ and a penultimate vowel other than /a/ such as *nima* → *niim* 'five'.

Phonetically, such final non-syllabic vowels are usually realised by the organs of the mouth taking the position for the articulation of the root final vowel, but without any subsequent vibration of the vocal cords. When the final consonant is a voiceless plosive there is also a subsequent puff of air. After other consonants there is not usually any additional sound or air expelled.

Final non-syllabic vowels were judged by my Se'i consultants to be different from normal vowels, and forms with a syllabic vowel were interpreted as U-forms. In the case of *na-naang* 'braid' [nə'naŋ] ◀ one of my consultants stated, "There's clearly an *o* but it doesn't leave [the mouth]." (*kentara o, tapi tidak keluar*) and regarding *na-maani* 'laugh' [nəmaŋ] ◀ they stated "It's like there is an *i* at the end, but the *i* is lost." (*ke ada i di belakang, tapi i-nya hilang*)

Based on current textual data it appears that the Se'i Amanuban forms are an additional M-form which might only be used phrase finally while normal M-forms with metathesis are used phrase medially.¹⁵ However, a more comprehensive investigation of Se'i Amanuban is needed to properly determine how U-forms and different M-forms are used in this variety of Meto. An example of each kind of M-form is given in (56) which shows a normal M-form of *√honi* 'give birth' medially and an M-form with non-syllabic vowel phrase finally.

¹⁴In known varieties of Fatule'u and Amfo'an with such vowel reduction, it only affects words with a final back vowel /o/ or /u/. This is also the case for Timaus spoken in Sanenu.

¹⁵This is not to say that the use of each form in Se'i Amanuban is purely conditioned by phrase position. Instead, when an M-form is grammatically appropriate the selection of M-form might be determined by phrase position.

Table 4.14: Se'i Amanuban Citation Forms[†]

Root	Se'i citation	Phonetic		Amarasi M-form	gloss
√ <i>mani</i>	<i>n-maan̩i</i>	[n̩maːnj]	🔊	<i>n-main</i>	'laugh'
√ <i>mnasi</i>	<i>na-mnaas̩i</i>	[naːmnaːs̩j] [naːmnaːɕ̩:]	🔊	<i>na-mnais</i>	'old'
√ <i>honi</i>	<i>na-hoon̩i</i>	[naːhoːnj]	🔊	<i>na-hoin</i>	'be born'
√ <i>luli</i>	<i>n-luul̩i</i>	[nl̩ɕ̩:l̩j]	🔊		'burn'
√ <i>hake</i>	<i>n-haak̩e</i>	[nhaːk̩ɕ̩]	🔊	<i>n-haek</i>	'stand'
√ <i>mate</i>	<i>n-maat̩e</i>	[n̩maːt̩ɕ̩]	🔊	<i>n-maet</i>	'die'
√ <i>lole</i>	<i>na-lool̩e</i>	[naːloːl̩ɕ̩]	🔊		'far'
√ <i>loʔe</i>	<i>t-looʔ̩e</i>	[t̩loːʔ̩ɕ̩]	🔊		'swim'
√ <i>paumaka</i>	<i>paumaak̩a</i>	[pewˈmaːk̩ɕ̩]	🔊	<i>n-paumaak</i>	'near'
√ <i>mahata</i>	<i>n-mahaat̩a</i>	[n̩maːhaːt̩ɕ̩]	🔊	<i>n-mahaat</i>	'itchy'
√ <i>kiso</i>	<i>n-kiis̩o</i>	[nkiːs̩w]	🔊	<i>n-kius</i>	'see'
√ <i>tselo</i>	<i>na-tseel̩o</i>	[naːt̩sel̩ɕ̩]	🔊		'fall'
√ <i>meno</i>	<i>n-meen̩o</i>	[n̩m̩eːno]	🔊	<i>n-meon</i>	'thirsty'
√ <i>meto</i>	<i>n-meet̩o</i>	[n̩m̩eːt̩ɕ̩]	🔊	<i>n-meot</i>	'be dry'
√ <i>nano</i>	<i>na-naan̩o</i>	[neˈnaːno]	🔊	<i>na-kaon</i>	'braid'
√ <i>toko</i>	<i>t-took̩o</i>	[t̩oːkw̩]	🔊	<i>t-took</i>	'sit'
√ <i>hitu</i>	<i>hiit̩u</i>	[hiːt̩w]	🔊	<i>hiut</i>	'seven'
√ <i>inu</i>	<i>t-iin̩u</i>	[t̩in̩w]	🔊	<i>t-iun</i>	'drink'
√ <i>matleʔu</i>	<i>n-matleeʔ̩u</i>	[n̩mat̩leːʔ̩w]	🔊		'dream'
√ <i>tenu</i>	<i>teen̩u</i>	[t̩eːnw]	🔊	<i>teun</i>	'three'
√ <i>fanu</i>	<i>faan̩u</i>	[faːnw]	🔊	<i>faun</i>	'eight'
√ <i>ʔapu</i>	<i>na-ʔaap̩u</i>	[naːʔaːp̩w]	🔊		'pregnant'
√ <i>mofu</i>	<i>n-moof̩u</i>	[n̩moːfw]	🔊	<i>n-mouf</i>	'fall'

[†] Words were elicited from a group of three speakers and several sound files have multiple speakers giving the word at the same time.

(56) *n-ak*: “*ena hoo mu-hoin*” *n-ak*: “*au u-hoon̩i*”

n-ak ena hoo mu-honi n-ak au u-honi



3-ay mother 2SG 2SG-born\M 3-say 1SG 1SG-born\M

‘He said “Mother, have you given birth?”, she said “I’ve given birth”.’

NB-171026-4, 0.56 🔊

4 Structure of metathesis

In Timaus from Sanenu verbs and numerals with final /o/ and /u/ also have M-forms with a final non-syllabic vowel. In Timaus these are the M-forms used in all phrase positions and words which take such M-forms have not been attested with a normal M-form derived by simple metathesis. Three examples of such Timaus M-forms are given in (57) and (58) below. The second instance in (57) is phrase final while the other two instances in (57) and (58) are phrase medial.

- (57) *atoni? teenu, bifee-l teenu*
atoni? tenu bifee-l tenu
man three\M woman-U three\M
'Three men and three women.' FGT-171013-1, 0.31 
- (58) *hai m-eku kotugw le? iin*
hai m-eku koto-gw le? iin
1PX 1PX/2-eat\M hyacinth.bean-U REL 1DEM
'We ate these hyacinth beans.' FGT-171016-2, 2.05 

Final non-syllabic vowels in varieties of Meto such as Se'i Amanuban are intermediate between fully unmetathesised and fully metathesised forms. However, while I have attested forms with an intermediate sequence of two identical vowels and final non-syllabic vowel such as *tenu* → *teenu* 'three', I do not yet have any clear examples of forms with a final non-syllabic vowel and intermediate sequence of two different vowels such as **teunu*.

4.5.3 Loss of final consonants

The final process which needs to be accounted for in the derivation of M-forms in Amarasi is deletion of final consonants of nominals. This is seen in the formation of M-forms of CVC# final words such as *mu?it* → *mui?* 'animal' (§4.2.3.1), as well as VVC# final words such as *kaut* → *kau* 'papaya' (§4.2.3.2). There are several pieces of evidence indicating that, diachronically, final consonant deletion preceded metathesis.

Firstly, in some varieties of Meto certain nominals derive their M-form only by consonant deletion. This is the case in Naitbelak and Nai'bais Amfo'an in which all VVC# final nominals, as well as CVC# final nominals whose final vowel is not /a/ mark attributive modification simply through consonant deletion. Examples

are given in Table 4.15. This system may attest an older system, with Amarasi then applying metathesis to (newly) CV# final words.¹⁶

Table 4.15: Naitbelak/Nai'bais Amfo'an consonant deletion

N ₁	+	N ₂	Phrase	N ₁	+	N ₂
<i>muke?</i>	+	<i>kase-l</i>	<i>muke kase-l</i>	'citrus'	+	'foreign'
<i>mu?it</i>	+	<i>fui-ɕʒ</i>	<i>mu?i fui-ɕʒ</i>	'animal'	+	'wild'
<i>manus</i>	+	<i>noo-f</i>	<i>manu noo-f</i>	'betel vine'	+	'leaves'
<i>fee mnasi?</i>	+	<i>amenat</i>	<i>fee mnasi amenat</i>	'old woman'	+	'sick'
<i>kuan</i>	+	<i>tuaf</i>	<i>kua tuaf</i>	'village'	+	'person'
<i>kaut</i>	+	<i>noo-f</i>	<i>kau noo-f</i>	'papaya'	+	'leaves'

Secondly, only nouns used attributively have final consonant deletion. As discussed in §4.2.3 and further exemplified in §7.4.2, verbs with a final consonant do not usually have distinct M-forms in Amarasi; the presence of a final consonant blocks verbal metathesis. This indicates that consonant deletion is a necessary precondition for metathesis to apply to consonant-final roots.

Thirdly, before CC-initial modifiers final consonant deletion is the only marker of the M-form, with a word like *mu?it* 'animal' taking the M-form *mu?i*. This consonant deletion is discussed further in §4.6 below.

Fourthly, despite the fact that Ro'is Amarasi permits clusters of three consonants (§4.6.3), the final consonant of VVC# words is still deleted before CC-initial modifiers, i.e. *kniit* 'crab' + *snaen* 'sand' → *knii_snaen* 'horned ghost crab'.

These facts indicate that at an earlier stage of Amarasi final consonants of nouns were deleted before attributive modifiers; in the same way as they still are before CC-initial modifiers, or as is still found with the surface M-form of VVC# final words.

While deletion of final consonants can be analysed synchronically as a result of a prohibition against final consonant clusters created after metathesis, from a diachronic perspective deletion of final consonants probably occurred first, with this consonant deletion then opening the way for metathesis to apply to consonant-final roots.

¹⁶Naitbelak/Nai'bais Amfo'an attributive modification for vowel-final words is marked by a lack of consonant insertion, an example is *fafi-ɕʒ* 'pig' + *ana?* 'small, baby' → *fafi ana?* 'piglet'. CVC# final words with final /a/ mark modification through consonant deletion and metathesis. An example is *ekam* 'pandanus' + *nenog* 'day/sky' → *eek nenog* 'wild pandanus'. See Culhane (2018) for more details.

4.5.4 Morphologisation of metathesis

The Ro'is Amarasi data with stressed vowel diphthongisation and varieties of Meto with M-forms with final non-syllabic vowels attest intermediate stages between fully unmetathesised forms (e.g. *fatu*) and fully metathesised forms (e.g. *faut*) which are consistent with the development of compensatory metathesis as predicted by Blevins & Garrett (1998).

The final stage in the development of Amarasi metathesis was for the prosodic environments in which each form occurred to be reinterpreted as different morphological environments (Chapters 6 and 7). This creation of a paradigm of morphological metathesis probably partly led to the imposition of the CVCVC template to all words of the language in order to provide the necessary machinery for consonant-vowel metathesis to operate and thereby allow each word to fill both cells of the morphological paradigm.

Finally, recall from Chapter 2 that final CV → VC metathesis occurs in several languages of Timor including Helong and Mambae. The presence of metathesis in these three languages is almost certainly due to historic contact. In the case of Helong and Meto, such contact is still ongoing, while Mambae and Meto are no longer in contact with one another. Thus, while final CV → VC metathesis may have first arisen according to the process of compensatory metathesis as described above, it is unlikely that these processes occurred independently in each of Meto, Helong, and Mambae. Instead they likely occurred in one of these languages from which they then diffused into the others. Which of these languages first acquired metathesis remains to be investigated.

4.6 M-forms before consonant clusters

In the previous sections I described and analysed the basic M-form. This is the M-form taken by vowel-final verbs, as well as nouns before an attributive modifier with only a single initial consonant. In addition to the basic M-form, Amarasi has an additional M-form which is used by nouns before attributive modifiers which begin with a consonant cluster. This M-form is derived by deletion of any final consonant with no further changes.

M-forms before consonant clusters are glossed with $\text{'\overset{c}{M}}$ (M with a 'c' for consonant above it). $\overset{c}{M}$ -forms are the paradigmatic and morphological equivalents of basic M-forms in a different phonological environment. Basic M-forms occur before attributive modifiers which begin with a single consonant, while $\overset{c}{M}$ -forms occur before attributive modifiers with an initial cluster. This process is not pre-

dictable consonant deletion to avoid a cluster of three consonants. (Such clusters are avoided in other situations by epenthesis of /a/ as discussed in §3.5).

Examples of \dot{M} -forms are shown in (59) below for each word shape. The modifiers used to illustrate are *mnasi?* ‘old’, *kbubu?* ‘round’, *mnanu?* ‘long’ and *mnatu?* ‘ripe, cooked’ as semantically appropriate. Words which end in a vowel in the U-form do not have distinct M-forms before modifiers which begin with a consonant cluster. It is possible at an abstract level to analyse the M-form of such words as being formed by deletion of the final empty C-slot.

(59) $C\# \rightarrow \emptyset / _CC$

U-form	\dot{M} -form	
<i>mu?it</i>	\rightarrow <i>mu?i mnasi?</i>	‘old animal’
<i>kaut</i>	\rightarrow <i>kau mnatu?</i>	‘cooked/ripe papaya’
<i>nautus</i>	\rightarrow <i>nautu kbubu?</i>	‘round beetle’
<i>fafi</i>	\rightarrow <i>fafi mnasi?</i>	‘old pig’
<i>ume</i>	\rightarrow <i>ume kbubu?</i>	‘round house’
<i>aunu</i>	\rightarrow <i>aunu mnanu?</i>	‘long spear’
<i>oo</i>	\rightarrow <i>oo kbubu?</i>	‘round (piece of) bamboo’

The relationship between the surface forms of the U-form and \dot{M} -form *mu?it* \rightarrow *mu?i* ‘animal’ and *fafi* \rightarrow *fafi* ‘pig’ are shown in (60) and (61) below.

(60) ‘animal’

U-form:	m	u	?	i	t
	C	V	C	V	C
	↓	↓	↓	↓	
	C	V	C	V	
\dot{M} -form:	m	u	?	i	

(61) ‘pig’

U-form:	f	a	f	i
	C	V	C	V
	↓	↓	↓	↓
	C	V	C	V
\dot{M} -form:	f	a	f	i

VVC# words with a final /n/ form a partial exception to this rule when they occur before a modifier which begins with two nasals. In such instances either the final consonant is deleted, or it is retained and epenthesis occurs. One example is *kuan* ‘village’ modified by *mnaa?* ‘old, former’ in which case both *kua mnaa?* or *kuan a|mnaa?* occur with an attributive meaning.¹⁷

¹⁷Nekmese’ village was founded in the 1970s and many people still maintain fields and gardens near the old village (see §1.2 for more details). Thus, the phrase *kua(n a)mnaa?* is frequently heard. The form *kua mnaa?* is much more common in my experience.

4 Structure of metathesis

Likewise, when asked to translate ‘old tap’ into Amarasi (*kraan* ‘tap’ + *mnaa?* ‘old’), Roni (my main consultant) produced the string *kraan a/mnaa?* I immediately then presented him with the string *kraa mnaa?* which he interpreted as being ‘old glass’, from *kraas* + *mnaa?*

In §4.6.1 and §4.6.2 below I sketch a partial analysis of M-forms within Optimality Theory. I do this because the tableaux that this theory employs illustrate well the large number of potential outputs the combination of a noun followed by an attributive modifier could potentially generate. The purpose of this book is not to give a complete Optimality Theory account of metathesis in Amarasi. Indeed, the high level of opacity in the formation of M-forms – including at least one derived environment effect (§4.2.2.2) – indicates that standard Optimality Theory would not fare particularly well in Amarasi. Nonetheless Optimality Theory is still a useful tool to illuminate certain aspects of the structure of the language.

4.6.1 Consonant deletion

When a consonant-final word, such as *mu?it* ‘animal’, occurs before an attributive modifier with an initial cluster, such as *mnasi?* ‘old’, the final consonant of the first noun is deleted. This yields $[_{NP} \text{ mu?i mnasi?}]$ ‘an old animal’.

In such instances, there are a large number of potential outputs involving combinations of: metathesis, consonant deletion, and/or epenthesis. Each of these potential outputs is given in the Optimality Theory tableau in (63) below, along with the constraints they violate. The definitions constraints are given in (62). Their ranking is according to the order given.

- (62)
- a. *CC#: No final consonant clusters
 - b. *-CC-: No foot medial consonant clusters
 - c. *CCC: No clusters of three consonants
 - d. DEP: No epenthesis
 - e. MAX: No deletion
 - f. \M: Mark the M-form
 - g. LINEARITY: No metathesis

Constraint (62f) is equivalent to *REALIZEMORPHEME* in the sense of Kurisu (2001). This constraint is included as the forms under discussion are those which are paradigmatically and morphologically equivalent to the basic M-form which occurs before attributive modifiers with no initial cluster.

(63)

[_{NP} <i>mu?it</i> + <i>mnasi?</i>]	*CC#	*-CC-	*CCC	DEP	MAX	\M	LIN
a. <i>mui?it mnasi?</i>	*!		**				*
b. <i>mu?ti mnasi?</i>		*!					*
c. <i>mui? mnasi?</i>			*!		*		*
d. <i>mui mnasi?</i>					**!		
e. <i>mui?it a mnasi?</i>	*!			*			*
f. <i>mu?it mnasi?</i>			*!			*	
g. <i>mu?it a mnasi?</i>				*!		*	
h. <i>mu?i mnasi?</i>					*		

Table (63) shows that the output with deletion of the final consonant, *mu?i mnasi?*, is the best output. This candidate marks the M-form and also avoids final consonant clusters, foot medial clusters, clusters of three consonants, and epenthesis. While it does have consonant deletion, it only deletes one consonant while the next best candidate **mui mnasi?* has two consonants deleted.

When a consonant-final word occurs before a predicative modifier with an initial consonant cluster, epenthesis usually occurs between the two words. This is shown in (64) and (66) below, which can be contrasted with the attributive phrases in (65) and (67).

(64) [_{NP} *mu?it*] [_{NP} *a|mnasi?*]
 animal\U old
 ‘Animals are old.’

(65) [_{NP} *mu?i mnasi?*]
 animal\M old
 ‘(an) old animal’

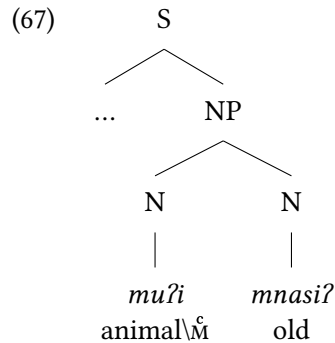
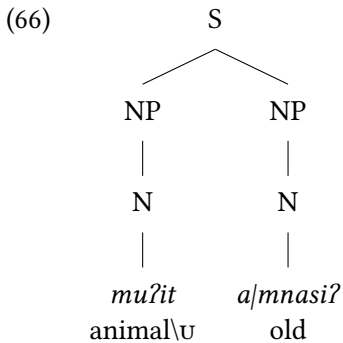

This can be explained by positing that while epenthesis is not allowed within a single phrase, it is allowed between two separate phrases. In the terminology of Optimality Theory, the constraint DEP is more highly ranked than MAX within a single phrase, while between two phrases MAX is more highly ranked than DEP.

4 Structure of metathesis

A modified version of table (63) is given in (68) below for predicative phrase with the constraints re-ordered as appropriate. The constraint $\setminus M$ ‘mark the M-form’ has been removed as this is not a requirement of predicative phrases.

(68)

	[_{NP} <i>muʔit</i>] + [_{NP} <i>mnasiʔ</i>]	*CC#	*-CC-	*CCC	MAX	DEP	LIN
a.	<i>muiʔt mnasiʔ</i>	*!		**			*
b.	<i>muʔti mnasiʔ</i>		*!				*
c.	<i>muiʔ mnasiʔ</i>			*!	*		*
d.	<i>mui mnasiʔ</i>				**!		
e.	<i>muiʔt a mnasiʔ</i>	*!				*	*
f.	<i>muʔit mnasiʔ</i>			*!			
g.	Ⓢ <i>muʔit a mnasiʔ</i>					*	
h.	<i>muʔi mnasiʔ</i>				*!		

Table (68) shows that when two separate noun phrases occur next to one another a cluster of three consonants is resolved by epenthesis. It is better to epenthesise between noun phrases than to have a cluster of three consonants.

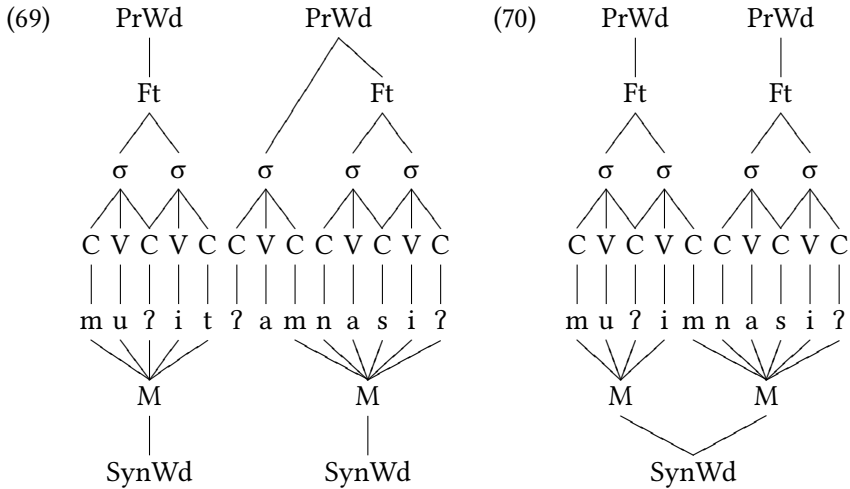

In an analysis which is considered in §6.8, I propose that members of an attributive phrase are members of a single category – the syntactic word – while each member of a predicative phrase is a member of a different syntactic word.¹⁸ The relationship between the prosodic structure, morphological structure, and

¹⁸This is essentially the same as proposing that attributive phrases are a (syntactic) compound, even though their members may belong to different prosodic categories.

the Syntactic Word(s) of the attributive phrase *mu?i mnasi?* ‘(an) old animal’, and the predicative phrase *mu?it a|mnasi?* ‘animals are old’ are shown in (69) and (70) above respectively.

When a consonant-final nominal occurs before a modifier with an initial consonant cluster, the cluster of three consonants is usually resolved in Amarasi. In an attributive phrase, such as that represented in (70), the M-form must be realised to mark the presence of this attributive modifier. Metathesis is blocked as it would result in a cluster of three consonants, as exemplified in (63). As a result, the final consonant of the first noun is deleted to express the M-form. This also has the effect of resolving the cluster of three consonants.

However, when the phrase consists of two syntactic words, such as that represented in (69), there is no need to mark the M-form. As a result, the cluster of three consonants remains. Epenthesis of /a/ (preceded by an automatic glottal stop – see §3.3.6) then occurs between these two syntactic words, thus resolving the cluster of three consonants.

4.6.2 No change

Vowel-final words do not have a distinct M-form before attributive modifiers with an initial cluster. Metathesis in this environment is blocked as it would create a cluster of three consonants. It is more important in Kotos Amarasi to avoid a cluster of three consonants than it is to mark the M-form.

However, there are at least two logical ways in which Amarasi could avoid a cluster of three consonants and still mark the M-form for CV# final words. Firstly, metathesis could occur with subsequent epenthesis: i.e. *fafi* ‘pig’ + *mnasi?* ‘old’ → **faif mnasi?* → **faif a|mnasi?*. Epenthesis is attested elsewhere in Amarasi to break up sequences of three consonants (§3.5). Secondly, metathesis could take place with subsequent deletion of the final consonant, **faif mnasi?* → **fai mnasi?*. Consonant deletion is attested elsewhere in the derivation of M-forms (§4.2.3.1, §4.2.3.2, §4.6.1).

We thus have at least four possible outputs when a CV# final word is modified by a nominal with an initial consonant cluster. Each of these potential outputs is given in the Optimality Theory tableau in (71) below, along with the constraint(s) they violate. These constraints and their ranking were given in (62) above.

4 Structure of metathesis

(71)	[_{NP} <i>fafi</i> + <i>mnasi?</i>]	*CCC	DEP	MAX	\M	LIN
a.	<i>faif mnasi?</i>	*!				*
b.	<i>faif a mnasi?</i>		*!			*
c.	<i>fai mnasi?</i>			*!		
d.	 <i>fafi mnasi?</i>				*	

Potential output (71a.) **faif mnasi?* does not occur because it is worse to have a cluster of three consonants than it is to mark the M-form. Potential output (71b.) **faif a|mnasi?* does not occur because it is worse to epenthesise (within a single phrase) than it is to mark the M-form. Potential output (71c.) **fai mnasi?* does not occur because it is worse to delete a medial consonant than it is to mark the M-form. This leaves the occurring output *fafi mnasi?*, which fails to mark the M-form but does not violate any of the more highly ranked constraints.

4.6.3 Ro'is Amarasi modifiers with an initial cluster

In Ro'is Amarasi metathesis occurs before words which begin with a consonant cluster. Examples are given in Table 4.16 on the next page alongside Kotos Amarasi equivalents (where known) for comparison.

Metathesis of CV(C)# final words is the most common pattern before CC-initial modifiers in my Ro'is data. However, two other patterns are also found.¹⁹ Firstly, there are two examples in my corpus in which metathesis does not occur: *smana-f* 'spirit' + *kninu?* 'clean, holy' → *smana kninu?* 'Holy Spirit' and *hana-f* 'voice' + *tbaat* 'lies across, in-between' → *hana tbaat* 'intermediate dialect'.²⁰

Secondly, diphthongisation of the stressed vowel (§3.4.1.2) without metathesis can also occur. There are six examples in my data of which three are: *umi* 'house' + *kbubu?* 'round' → *ūmi kbubu?* 'round house' (alongside Ro'is *uim kbubu?*, Kotos *umi kbubu?*), *nenō* 'day' + *krei* 'church' → *nēno krei* 'Sunday' (alongside Ro'is *neon krei*, Kotos *nenō krei*), and *rasi* 'matter' + *skoor* 'school' → *rāsi skoor* 'school matters' (Kotos *rasi skoor*). Given that diphthongisation of stressed vowels followed by a closed syllable is an automatic process in Ro'is (see §3.4.1.2), it is probably best to analyse such instances as underlyingly unmetathesised, with an automatic phonological rule applying. Nonetheless, diachronically, such forms are intermediate between metathesised and unmetathesised forms, as was discussed in §4.5.

¹⁹These alternate patterns are most frequent for one of my consultants from Tunbaun, though do sporadically occur in the speech of others.

²⁰The same speaker also uses *haan tbaat* 'intermediate dialect' at another point in the same text.

4.6 M-forms before consonant clusters

Table 4.16: Ro'is metathesis before consonant clusters

Noun	mod.		Ro'is	Kotos	
<i>kruru-f</i>	+ <i>tnana-f</i>	→	<i>kruur tnanaf</i>	<i>kruru tnanaf</i>	'middle finger'
'finger'	+ 'middle'				
<i>umi</i>	+ <i>kbubu?</i>	→	<i>uim kbubu?</i>	<i>umi kbubu?</i>	'round house'
'house'	+ 'round'				
<i>teno?</i>	+ <i>kmoro-f</i>	→	<i>teon kmorof</i>	<i>teno kmorof</i>	'egg yolk'
'egg'	+ 'yellow'				
<i>fatu</i>	+ <i>kruru-f</i>	→	<i>faut_kruruf</i>	<i>fatu kruruf</i>	'soft coral'
'stone'	+ 'finger'				
<i>ika?</i>	+ <i>tnopos</i>	→	<i>iik_tnopos</i>		'silver moony (<i>Monodactylus argentus</i>)'
'fish'	+ 'silver'				
<i>ika?</i>	+ <i>kbiti</i>	→	<i>iik_kbiti</i>		'spinefoot (<i>Siganus spp.</i>)'
'fish'	+ 'scorpion'				

Finally, VVC# final words in Ro'is delete their final consonant before all modifiers, including modifiers with an initial cluster, to derive an M-form in the same way as Kotos (§4.2.3.2). Two examples from my Ro'is data are: *knaa?* + *mnanu?* 'long' → *knaa mnanu?* 'long beans' and *kniit* 'crab' + *snaen* 'sand' → *kniit snaen* 'horned ghost crab (*Ocypode ceratophthalma*)'. Given that Ro'is permits clusters of three consonants, deletion of the final consonant in these instances provides additional evidence that the consonant deletion Kotos Amarasi is indeed a morphological process.

5 Phonologically conditioned metathesis and associated processes

5.1 Introduction

In this chapter I discuss the use of M-forms (metathesised forms) before vowel-initial enclitics, as well as the other phonological process with which it occurs. Such M-forms occur only before vowel-initial enclitics and it is possible to analyse them as conditioned by the this environment.¹ M-forms before an enclitic boundary are glossed \bar{m} (M with an equals sign for clitic above it). Three phonological processes, including metathesis, are triggered before vowel-initial enclitics. These processes are summarised in (1) below.

- (1) Processes at Enclitic Boundaries
 - a. Metathesis
 - b. Consonant Insertion
 - c. Vowel Assimilation

In this chapter I present an analysis of these processes. Metathesis is triggered by CRISP-EDGE; the need to keep prosodic words phonologically distinct (§5.2). Consonant insertion is triggered by the need for feet to have an onset consonant (§5.3). Vowel assimilation is triggered by metathesis occurring after consonant insertion (§5.4).

The behaviour of stems before vowel-initial enclitics is quite diverse between different varieties of Meto and it must be emphasised that the discussion here only describes Kotos Amarasi as spoken in the hamlet of Koro'oto. Occasional notes on other varieties of Meto occur at some points as relevant and more extensive comparative data is presented in §5.8.

¹The processes described in this chapter only occur before vowel-initial enclitics. Comparable environments do not exist in Amarasi. Vowel-initial suffixes – of which there are only two (see §A.3.4 and §A.3.5) – only occur on VVC# final stems which remain unchanged before vowel-initial enclitics.

5 Phonologically conditioned metathesis and associated processes

The Amarasi vowel-initial enclitics, all of which trigger these processes, are given in Table 5.1.² The enclitics *=ii*, *=ein* and *=ee* have different uses when attached to verbs than they do with nouns. The enclitic *=ein* displays some complex allomorphy and is associated with unusual consonant insertion (§5.6). The function and syntactic behaviour of most of these enclitics is discussed in Chapter 6.

Table 5.1: Amarasi vowel-initial enclitics

Form	Gloss	Use
<i>=ii</i>	1DET	definite referent near/relevant to speaker
	1DET	raises discourse prominence
<i>=aan/=ana</i>	2DET	definite referent near/relevant to addressee
<i>=ee</i>	3DET	definite referent near/relevant to a third person
	3SG.ACC	third person P argument (object) of verb
<i>=aa</i>	0DET	definite referent near/relevant to no one (\approx obviative)
<i>=ein/=eni</i>	PL	definite plural
	PL	third person plural verbal argument (S/A/P)
<i>=ees/=esa</i>	one	the numeral one (1); indefinite singular
<i>=een/=ena</i>	INCEP	inceptive, beginning of state/event
<i>=aah/=aha</i>	just	restrictive
<i>=oo-n</i>	REFL	reflexive (takes genitive suffix §A.3.1)

In addition to these vowel-initial enclitics, the vowel-initial forms of the sentence enclitics *=ma/=ama* ‘and’ and *=te/=ate* SUB occasionally, though not obligatorily, trigger metathesis on their host. The vowel-initial allomorphs of these enclitics only occur after consonant-final stems in my data.

The structure of the M-form of stems before these vowel-initial enclitics is summarised in Table 5.2 according to the nine unique surface phonotactic shapes of U-forms which can be identified. The different M-forms in Table 5.2 are completely predictable based on the corresponding U-form, while the M-forms are not fully predictive of the U-forms.

In this chapter I describe each of these M-forms in detail and analyse the ways in which these M-forms are derived from the U-form. This analysis has two funda-

²In Edwards (2016b) I analysed many of these vowel-initial enclitics as containing only a single vowel, in line with their usual phonetic realisation. Since then, I have collected comparative data from other varieties of Meto which is best analysed by positing that *all* these enclitics have two underlying vowels. This evidence is presented in §5.8.

Table 5.2: Amarasi M-forms before enclitics

	U-form	M-form	U-form	M-form	gloss
1.	$V_{1\alpha}C_1V_2\beta$	$\rightarrow V_{1\alpha}V_{\alpha}C_1C_{\beta}$	<i>fafi</i>	\rightarrow <i>faafɕ</i> =	‘pig’
2.	$V_1C_1V_2C_2$	$\rightarrow V_1V_2C_1C_2$	<i>muʔit</i>	\rightarrow <i>muiʔt</i> =	‘animal’
3.	$V_{1\alpha HI}C_1V_2\beta MID$	$\rightarrow V_{1\alpha}V_{\alpha}C_1C_{\beta}$	<i>ume</i>	\rightarrow <i>uumɕ</i> =	‘house’
4.	$V_{1\alpha}C_1a_2(C_2)$	$\rightarrow V_{1\alpha}V_{\alpha}C_1(C_2)$	<i>n-sosa</i>	\rightarrow <i>n-soos</i> =	‘buy’
5.	$V_1V_2C_1V_3\alpha$	$\rightarrow V_1V_2C_1C_{\alpha}$	<i>n-aiti</i>	\rightarrow <i>n-aitɕ</i> =	‘pick up’
6.	$V_1V_2C_1V_3C_2$	$\rightarrow V_1V_2C_1C_2$	<i>nautus</i>	\rightarrow <i>nauts</i> =	‘beetle’
7.	$V_1V_2C_1$	$\rightarrow V_1V_2C_1$	<i>kaut</i>	\rightarrow <i>kaut</i> =	‘papaya’
8.	$V_{1\alpha}V_2\beta$	$\rightarrow V_{1\alpha}V_{\alpha}C_{\beta}$	<i>ai</i>	\rightarrow <i>aafɕ</i> =	‘fire’

mental elements: feet should begin with a consonant and prosodic words should be phonologically separate from one another.

5.2 Metathesis

Metathesis is obligatorily triggered before vowel-initial enclitics. Examples of CVC# final stems before the enclitic =*ee* are given in (2). In each example metathesis of the penultimate consonant and final vowel occurs before the enclitic.

(2) $\dots V_1C_1V_2C_2 \rightarrow \dots V_1V_2C_1C_2=V$

<i>ramup</i>	+	= <i>ee</i>	\rightarrow	<i>raump=ee</i>	‘lamp’
<i>muʔit</i>	+	= <i>ee</i>	\rightarrow	<i>muiʔt=ee</i>	‘animal’
<i>tenuk</i>	+	= <i>ee</i>	\rightarrow	<i>teunk=ee</i>	‘umbrella’
<i>tenoʔ</i>	+	= <i>ee</i>	\rightarrow	<i>teonʔ=ee</i>	‘egg’
<i>ukum</i>	+	= <i>ee</i>	\rightarrow	<i>uukm=ee</i>	‘cuscus’
<i>poʔon</i>	+	= <i>ee</i>	\rightarrow	<i>pooʔn=ee</i>	‘garden’
<i>oʔof</i>	+	= <i>ee</i>	\rightarrow	<i>ooʔf=ee</i>	‘pen, corral’
<i>manus</i>	+	= <i>ee</i>	\rightarrow	<i>mauns=ee</i>	‘betel vine’
<i>anah</i>	+	= <i>ee</i>	\rightarrow	<i>aanh=ee</i>	‘child’
<i>motor</i>	+	= <i>ee</i>	\rightarrow	<i>mootr=ee</i>	‘motorbike’

I analyse this metathesis as occurring due to a crisp edge constraint. This constraint prohibits a single element from being linked to more than one prosodic category. It is given in (3) below, as first described by Itô & Mester (1999: 208). (The symbol ‘*C*’ represents a prosodic category such as a foot, a syllable, or a

5 Phonologically conditioned metathesis and associated processes

prosodic word and ‘ α ’ is an element which is linked to more than one prosodic category.)

- (3) CRISP-EDGE: “Multiple linking between prosodic categories is prohibited”

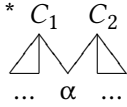

The constraint in Amarasi is CRISP-EDGE[PrWd], given in (4) below, which prohibits elements from being linked to more than one prosodic word. Other prosodic categories in Amarasi can have multiple elements such as the medial C-slot of a foot which is ambisyllabic and linked to two syllables (§3.3.1).

- (4) CRISP-EDGE[PrWd]

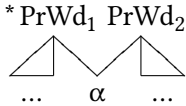

Recall from §3.3.4 that enclitics are extra-metrical and do not count for stress. Instead, stress is assigned to the penultimate syllable of the clitic host. I analyse this otherwise aberrant stress pattern as resulting from a recursive prosodic word structure $\text{PrWd}[\text{PrWd}[\text{HOST}]=\text{cl}]$, in which the clitic does not form an independent prosodic word but is parsed together with the clitic host. Stress is then assigned to the most deeply embedded prosodic word.³

When a consonant-initial enclitic attaches to a host the resulting prosodic structure does not violate CRISP-EDGE[PrWd] as no segments are linked to both the internal and external prosodic word. Examples of consonant-initial enclitics (before which metathesis is not obligatory) are given in (5) below, which shows a number of verbs with consonant-initial pronominal enclitics attached.⁴

³Thanks goes to Daniel Kaufman for suggesting this analysis.

⁴CV# final enclitics take the U-form or M-form according to discourse structures (Chapter 7).

(5) No metathesis before =#C

<i>n-roro?</i>	+	= <i>kau</i>	→	<i>na-?koro?=kau</i>	'tricks me'
<i>na-nani?</i>	+	= <i>koo</i>	→	<i>na-nani?=koo</i>	'moves you'
<i>na-fani-?</i>	+	= <i>kii</i>	→	<i>na-fani-?=kii</i>	'returns it to you (pl.)'
<i>n-o?en</i>	+	= <i>kiit</i>	→	<i>n-o?en=kiit</i>	'calls to us (incl.)'
<i>na-barab</i>	+	= <i>kai</i>	→	<i>na-barab=kai</i>	'prepares us (excl.)'
<i>na-reta?</i>	+	= <i>siin</i>	→	<i>na-reta?=siin</i>	'tells them a story'
<i>t-biku</i>	+	= <i>siin</i>	→	<i>t-biku=siin</i>	'curse them'
<i>au uisneno</i>	+	= <i>kau</i>	→	<i>au uisneno=kau</i>	'I am God'
<i>hii maufinu</i>	+	= <i>kii</i>	→	<i>hii maufinu=kii</i>	'you are evil'

The prosodic structures and morphological structures of *na-nani?=koo* 'moves you' and *na-barab=kai* 'prepares us' are given in (6). These show that no element is attached to both prosodic words. There is a crisp-edge after the internal prosodic word boundary, as indicated by the dashed line.

Similarly, given the presence of empty C-slots (§3.3.7), a structure such as *t-biku=siin* 'curse them' also has a crisp edge between the host and enclitic, as illustrated in (7) below.

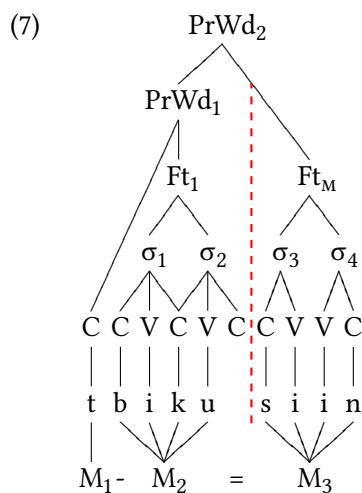
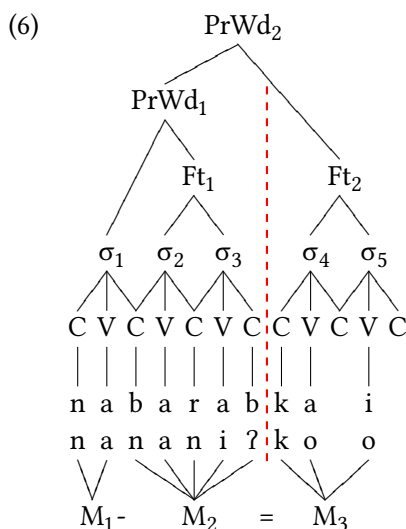

However, vowel-initial enclitics have a defective foot structure with no initial C-slot. That is, rather than taking the otherwise obligatory CVCVC foot their foot structure is VCVC (§3.3.2). As a result, the final C-slot of the clitic host is the onset C-slot for the initial syllable of the enclitic.

5 Phonologically conditioned metathesis and associated processes

This is illustrated in (8a) below, which shows the structures of *mu?it* ‘animal’ + =*ee* and *ukum* ‘cuscus’ + =*ee* before metathesis takes place. The final C-slot of the host is ultimately linked to both the internal prosodic word (PrWd₁) and the external prosodic word (PrWd₂) as mediated by the syllabic and foot structures of the host and enclitic, thus violating CRISP-EDGE[PrWd]. This illicit structure is resolved by final CV → VC metathesis of the clitic host. This yields the structure in (8b) in which the final C-slot of the host is only linked to the following prosodic structures; the prosodic structures of the enclitic.

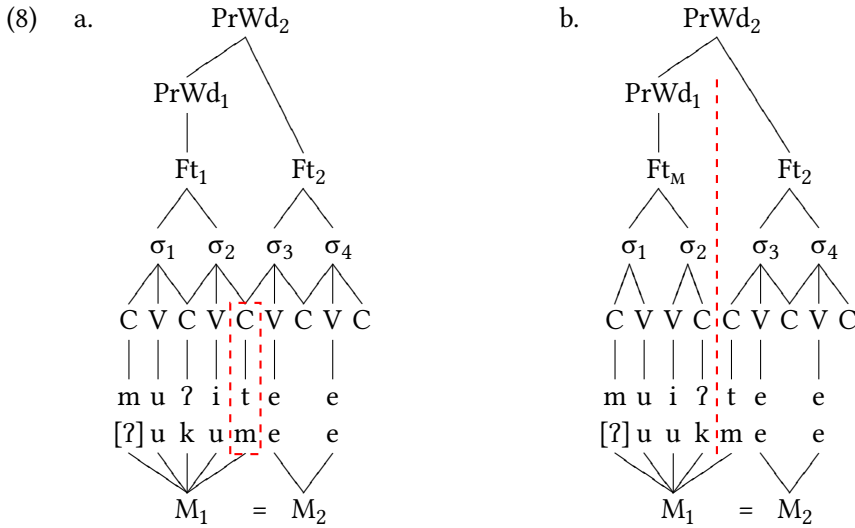

This analysis is dependent on the analysis of intervocalic consonants as ambisyllabic (§3.3.1) – that is being both the coda for the previous syllable and onset for the following syllable. If the intervocalic consonant were not ambisyllabic, CRISP-EDGE[PrWd] would not be violated and metathesis would not be necessary. The analysis of intervocalic consonants as ambisyllabic in Amarasi finds independent support from reduplication (§3.3.5), in which the initial syllable – including the intervocalic consonant – is the reduplicant.

In the case of root final consonants, as in (8) above, metathesis results in a mismatch between the prosodic and morphological structures of the clitic host and enclitic. While the final consonant is morphologically a member of the clitic host, phonologically it is a member of the enclitic.

Such a mismatch does not occur when the final consonant of the host is a suffix. The structures of two stems with a final suffix and vowel-initial enclitic are shown in (9) below; both before metathesis in (9a) and after metathesis in (9b).

These words are \sqrt{moni} ‘live’ + $-t$ ‘NML’ \rightarrow $moin-t=ee$ ‘the life’ and $feto$ ‘man’s sister’ + $-f$ ‘GEN’ + 3DET \rightarrow $feot-f=ee$ ‘the sister’.

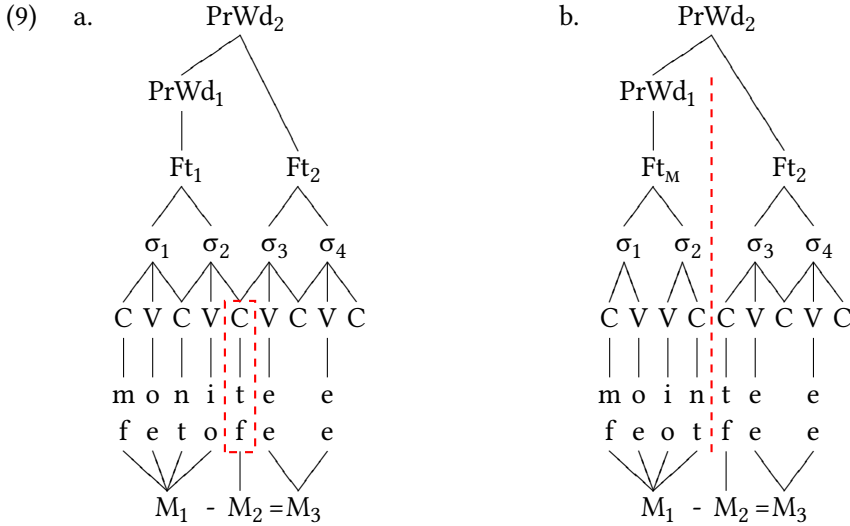

Similarly, for vowel-final hosts after which consonant insertion occurs (§5.3), the consonant which occurs in this C-slot is neither morphologically a member of the host or the enclitic.

5.3 Consonant insertion

When a vowel-initial enclitic is attached to a vowel-final stem, a consonant conditioned by the final vowel of the stem is inserted. After the front vowels /i/ and /e/ the inserted consonant is /ɖ/. After the back rounded vowels /u/ and /o/ the inserted consonant is /gw/. Examples are given in (10) below. (Consonant insertion after /a/ is discussed in §5.5 below.)

(10) $VV[+\alpha PLACE] += V \rightarrow VVC[+\alpha PLACE] = V$

<i>nii</i>	+	<i>=ee</i>	\rightarrow	<i>niiɖ=ee</i>	‘the pole’
<i>fee</i>	+	<i>=ee</i>	\rightarrow	<i>feeɖ=ee</i>	‘the wife’
<i>kfu</i>	+	<i>=ee</i>	\rightarrow	<i>kfuugw=ee</i>	‘the star’
<i>oo</i>	+	<i>=ee</i>	\rightarrow	<i>oogw=ee</i>	‘the bamboo’

This consonant insertion takes place because feet in Amarasi require an onset consonant. The requirement for an onset is a very common cross-linguistically (McCarthy & Prince 1993a; Prince & Smolensky 1993/2002).

5 Phonologically conditioned metathesis and associated processes

The requirement for feet to begin with an onset consonant is also the reason for glottal stop insertion (§3.3.7.5), as illustrated for the vowel-initial stem *ukum* ‘cuscus’ in (11a) below. Because feet require an initial consonant, a glottal stop is inserted in (11b). The glottal stop is the default initial consonant. (These representations in (11) have been simplified by removing the tiers showing the prosodic words and morphemes.)

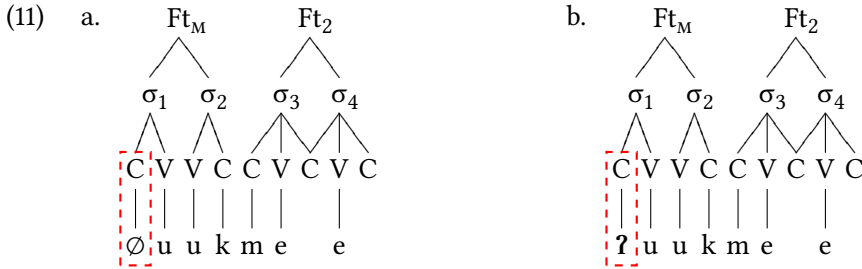

Instead of inserting a glottal stop, empty C-slots at clitic boundaries are usually filled by the features of the previous vowel spreading. Before vowel-initial enclitics this results in either /ɖʒ/ or /gw/, depending on the quality of the vowel which spreads. The way this works is illustrated in (12) below for the words *nii* → *niiɖʒ=ee* ‘pole’ and *fee* → *feeɖʒ=ee* ‘wife’.

Example (12a) shows the structure of these words before metathesis. The initial C-slot of the foot containing the enclitic is empty. In order to provide this foot with an onset, the feature [+FRONT] of the previous V-slot spreads, resulting in the consonant /ɖʒ/ in (12b).

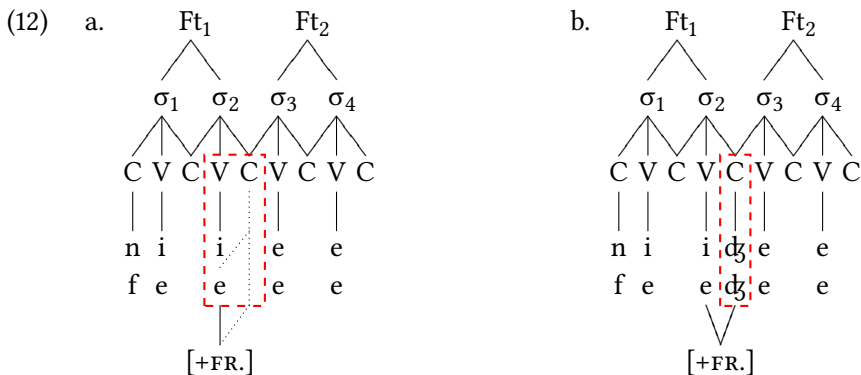

The process is the same when /gw/ is inserted. This is shown for *kfu* → *kfuugw=ee* ‘star’ and *oo* → *oogw=ee* ‘bamboo’ in (13) below. In (13a) the initial C-slot of the second foot is empty. As a result, the features [+BACK,+ROUND] of the

previous vowel spread producing the consonant /gw/ in (13b). The initial empty C-slot of oo ‘bamboo’ is also filled by a glottal stop in (13b).

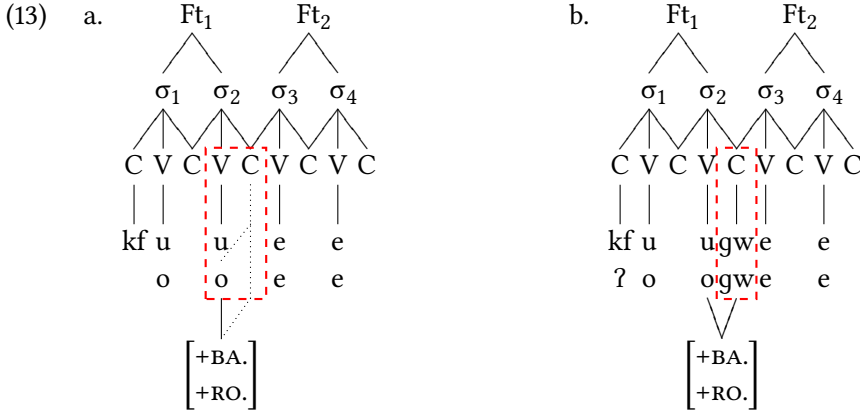

The newly-inserted consonant in (12) and (13) is shared between the prosodic word containing the host and the prosodic word containing the enclitic, as illustrated in (14a) below. This is resolved by metathesis, which yields the structure in (14b) with a crisp edge after the internal prosodic word.

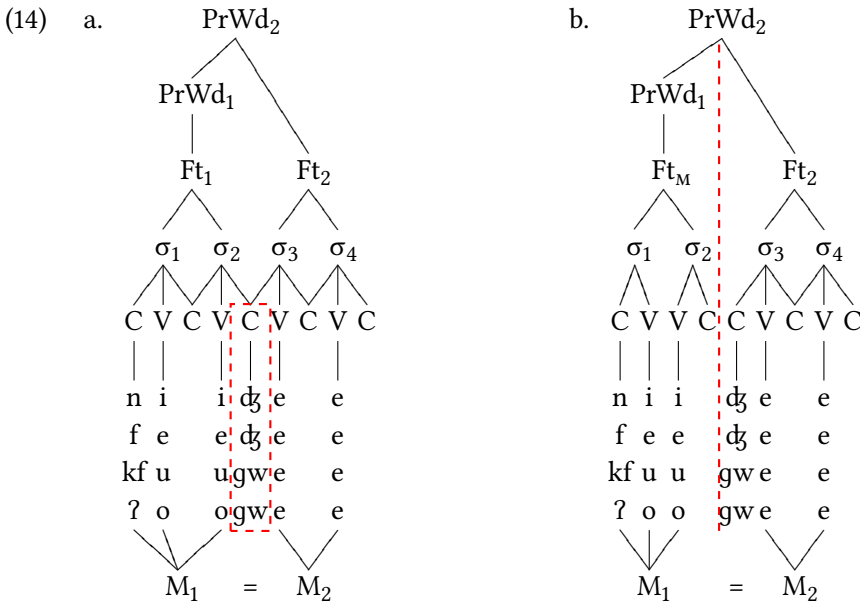

For words which contain a surface vowel sequence, the C-slot affected by metathesis is empty. As a result, metathesis has no discernible effect on the surface structure of such words. However, in §5.4 I show that we can still detect metathesis for words in which the surface vowel sequence involves vowels of different qualities.

The reason vowel features spread at clitic boundaries rather than simply inserting a glottal stop is not immediately clear. One possibility is that the glottal stop is only inserted word initially. However, this does not account for glottal stop insertion in examples such as *n-ita* ‘see’ → *na-ʔita-b* ‘show’ (§3.3.6.1), in which case the inserted glottal stop is not word-initial.

Another possible reason could be due to the differing morphological structures. Glottal stop insertion happens at affix boundaries while vowel features spread at clitic boundaries. However, this runs counter to the general principle that the phonological structures of Amarasi are ‘blind’ to the morphological structures.

Another possible reason why vowel features spread at clitic boundaries could be that the C-slot which is filled by /ɟ/ or /gw/ is the final C-slot of the previous foot. This is the analysis I currently favour, though it seems somewhat counter intuitive given that the whole reason vowel features spread is to provide the following clitic with an onset.

Given the presence of glottal stop insertion word initially in forms such as *ukum* → [ʔøkʊm] ‘cuscus’ and foot initially in words such as *n-ita* ‘see’ → *na-ʔita-b* ‘show’, there does not currently seem to be a good phonological reason why such glottal stop insertion does not also happen at clitic boundaries. It may simply be a fact of Amarasi that at clitic boundaries vowel features spread to produce /ɟ/ and /gw/.

5.3.1 Location of the inserted consonant

Amarasi consonant insertion can be analysed as a result of vowel features spreading into an adjacent empty C-slot. However, this empty C-slot could logically originate with the foot containing the clitic host, or the foot containing the enclitic. There are at least three reasons for analysing this empty C-slot as originating with the foot of the clitic host rather than the enclitic:

- i. It simplifies the analysis of consonant-final words.
- ii. There are varieties of Meto in which consonant insertion occurs with no enclitic present (§3.3.7.6.1).
- iii. It can provide a reason vowel features spread to produce an onset rather than glottal stop insertion.

Regarding the first point above, if the empty C-slot originated with the enclitic, forms such as *muʔit+=ee* ‘the animal’ → *muiʔt=ee* would be underlyingly *muʔit+=Cee* and we would probably expect something like **muʔittee*, (cf. gemination in Seri, discussed by Marlett & Stemberger 1983: 631). Additional rules would then have to be introduced to avoid such forms.

While the empty C-slot probably originates with the foot of the clitic host, the consonant inserted in this C-slot is not a member of the same morpheme as the clitic host. Instead, it is an epenthetic segment which does not belong to either the previous or following morpheme, much like epenthetic glottal stops (§3.3.6).

Nonetheless, the syllabification of Amarasi words (§3.3.1) means that when a vowel-initial enclitic is attached to a stem the final C-slot of this stem is ambisyllabic, occurring as the coda of the initial foot and as the onset of the foot containing the enclitic. As a result, it is a member of more than one prosodic word. This dual membership is the reason why metathesis is triggered before vowel-initial enclitics in Amarasi (§5.2). Metathesis rearranges the phonotactic structure of the host and enclitic such that after metathesis this C-slot is the onset to only one prosodic word.

5.4 Vowel assimilation

When a vowel-initial enclitic attaches to a stem which ends in a vowel sequence in which the vowels are of a different quality, the final vowel conditions insertion of /ɖʒ/ or /gw/, and then assimilates to the quality of the previous vowel. Examples are given in (15) below.

$$(15) \quad V_{\alpha}V_{\beta}+=V \rightarrow V_{\alpha}V_{\alpha}C_{\beta}+=V$$

<i>krei</i>	+	=ee	→	<i>kreeɖʒ=ee</i>	‘the church/week’
<i>fai</i>	+	=ee	→	<i>faaɖʒ=ee</i>	‘the night’
<i>n-roi</i>	+	=ee	→	<i>n-rooɖʒ=ee</i>	‘carries it’
<i>pui</i>	+	=ee	→	<i>puuɖʒ=ee</i>	‘the quail’
<i>mae</i>	+	=ee	→	<i>maaɖʒ=ee</i>	‘the taro’
<i>oe</i>	+	=ee	→	<i>ooɖʒ=ee</i>	‘the water’
<i>kiu</i>	+	=ee	→	<i>kiigw=ee</i>	‘the tamarind’
<i>n-keu</i>	+	=ee	→	<i>n-keegw=ee</i>	‘shaves it’
<i>hau</i>	+	=ee	→	<i>haagw=ee</i>	‘the wood/tree’
<i>meo</i>	+	=ee	→	<i>meegw=ee</i>	‘the cat’
<i>ao</i>	+	=ee	→	<i>aagw=ee</i>	‘the slaked lime’

5 Phonologically conditioned metathesis and associated processes

When a vowel-initial enclitic attaches to a stem which ends in CV#, the final vowel conditions insertion of /dʒ/ or /gw/, metathesis takes place, and the vowel which conditioned consonant insertion assimilates to the previous vowel.

$$(16) V_{\alpha}CV_{\beta}+=V \rightarrow V_{\alpha}V_{\alpha}CC_{\beta}=V$$

<i>kbiti</i>	+	=ee	→	<i>kbiiitdʒ=ee</i>	‘the scorpion’
<i>kreni</i>	+	=ee	→	<i>kreendʒ=ee</i>	‘the ring’
<i>fafi</i>	+	=ee	→	<i>faafdʒ=ee</i>	‘the pig’
<i>oni</i>	+	=ee	→	<i>oondʒ=ee</i>	‘the bee; the sugar’
<i>uki</i>	+	=ee	→	<i>uukdʒ=ee</i>	‘the banana’
<i>kepe</i>	+	=ee	→	<i>keepdʒ=ee</i>	‘the tick (parasite)’
<i>bare</i>	+	=ee	→	<i>baardʒ=ee</i>	‘the place’
<i>nope</i>	+	=ee	→	<i>noopdʒ=ee</i>	‘the cloud’
<i>biku</i>	+	=ee	→	<i>biikgw=ee</i>	‘the curse’
<i>tefu</i>	+	=ee	→	<i>teefgw=ee</i>	‘the sugar-cane’
<i>fatu</i>	+	=ee	→	<i>faatgw=ee</i>	‘the stone’
<i>nopu</i>	+	=ee	→	<i>noopgw=ee</i>	‘the grave’
<i>hutu</i>	+	=ee	→	<i>huutgw=ee</i>	‘louse’
<i>nefo</i>	+	=ee	→	<i>neefgw=ee</i>	‘the lake’
<i>knafo</i>	+	=ee	→	<i>knaafgw=ee</i>	‘the mouse’
<i>koro</i>	+	=ee	→	<i>koorgw=ee</i>	‘the bird’

This vowel assimilation can be analysed as an automatic result of metathesis after consonant insertion. This is illustrated in (17) below for *fafi* → *faafdʒ=ee* ‘pig’, and *nope* → *noopdʒ=ee* ‘cloud’. In (17a) the second foot begins with an empty C-slot. Because feet require an onset, the features (abbreviated as +FR. = front) of the previous vowel spread, producing the obstruent /dʒ/ in (17b).

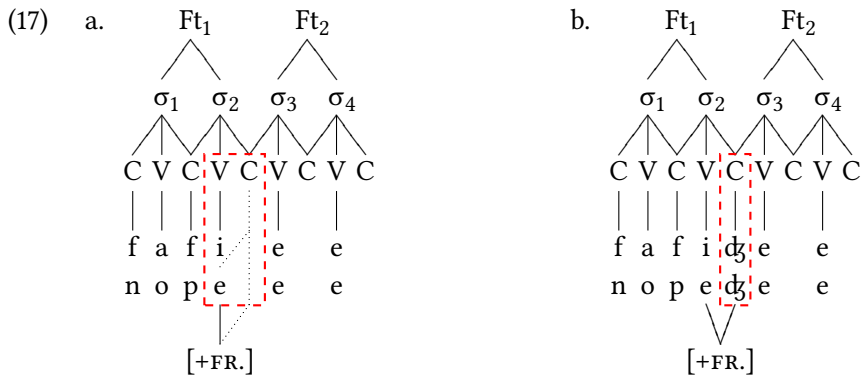

The third C-slot is shared between the external and internal prosodic words as shown in (17d). Because fuzzy borders are not allowed between prosodic words, metathesis is triggered, yielding the form in (17e) with a crisp edge between the clitic host and enclitic.

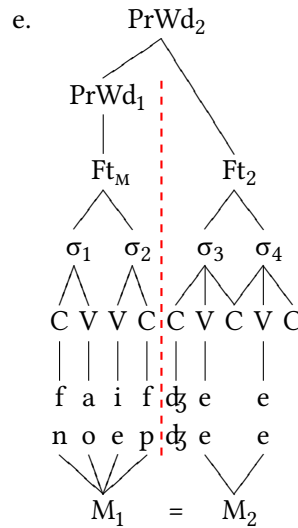
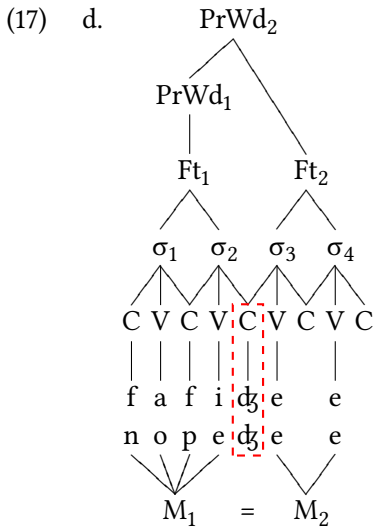

Metathesis results in the features of the final vowel of the clitic host shared across an intervening consonant. This results in ‘lines crossing’, as shown in (17f), with the intervening consonantal features represented by [+c.]. A prohibition against association lines crossing is one of the fundamental principles of autosegmental phonology (Goldsmith 1976: 48). Thus, the vowel features de-link yielding an empty V-slot in (17g) into which the previous vowel spreads, yielding the final output with a double vowel in (17h).

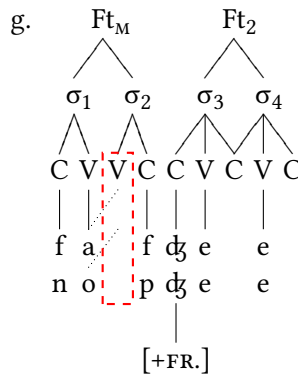
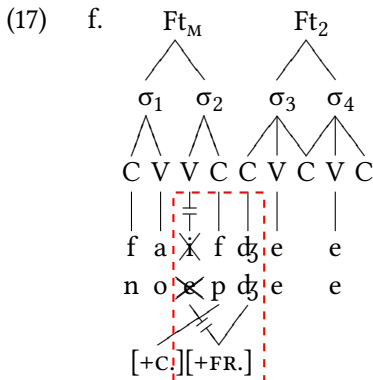

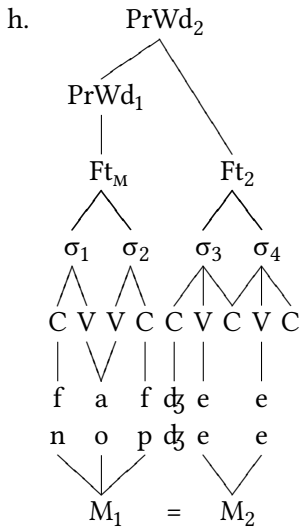

The reason vowel features de-link rather than consonant features is probably due to vowel assimilation/deletion being preferred over consonant assimilation in Amarasi. Vowel assimilation is attested in at least three other parts of the grammar of Amarasi while consonant assimilation is almost unattested.⁵ Other examples of vowel assimilation in Amarasi include the following:

- i. Assimilation of /a/ after metathesis; e.g. *nima* → *niim* ‘five’ (§4.2.2.2)
- ii. Height assimilation of mid vowels after metathesis; e.g. *ume* → *uim* ‘house’ (§4.2.2.1)
- iii. Phonetic partial height assimilation of mid vowels before high vowels; e.g. *koʔu* ‘big’ → [kɔʔɔ] *[kɔʔɔ] (§3.2.1).

By making use of empty C-slots, the analysis of vowel assimilation before vowel-initial enclitics as being triggered by an intervening consonant can be extended to words which end in a vowel sequence. This is illustrated in (18) below for the words *fai* → *faaɛ=ee* ‘night’, and *mae* → *maaɛ=ee* ‘taro’.

In (18a) the second foot begins with an empty C-slot. Because feet require an initial consonant, the features of the previous vowel spread, producing the obstruent /ɛ/ in (18b).

⁵The only example of consonant assimilation in Amarasi is phonetic assimilation of /n/ to the place of any following non-labial obstruent (§3.2.2).

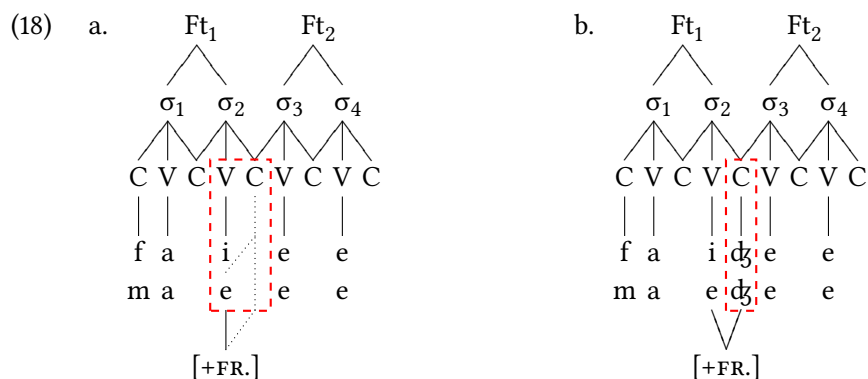

The recently filled C-slot is shared between the external and internal prosodic words, as shown in (18d). Because fuzzy borders are not allowed at prosodic word boundaries, metathesis is triggered, resulting in the form in (18e), in which there is a crisp edge between the host and enclitic.

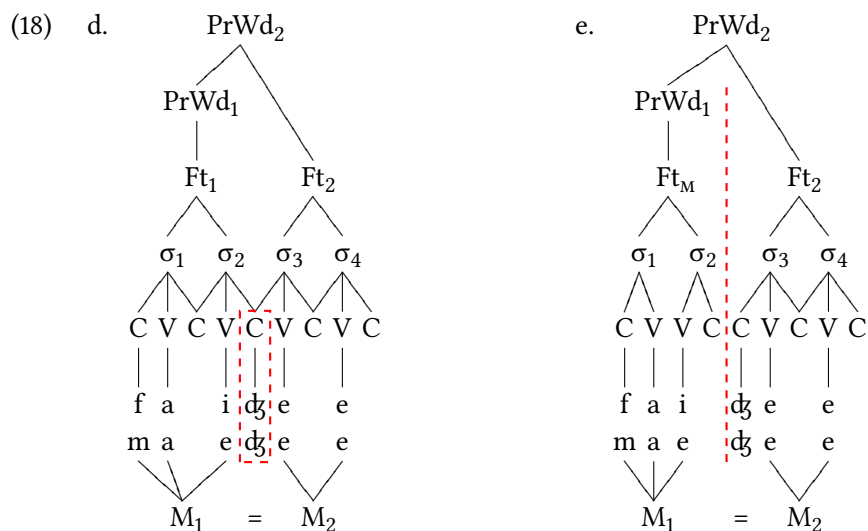

Metathesis results in the features of the final vowel of the clitic host being shared across an intervening C-slot. In this case the C-slot is 'filled' by a null consonant, whose features are represented as [-c.] in (18f). Because of this intervening consonant, the vowel features de-link yielding an empty V-slot in (18g) into which the previous vowel spreads, giving the final outputs in (18h).

5 Phonologically conditioned metathesis and associated processes

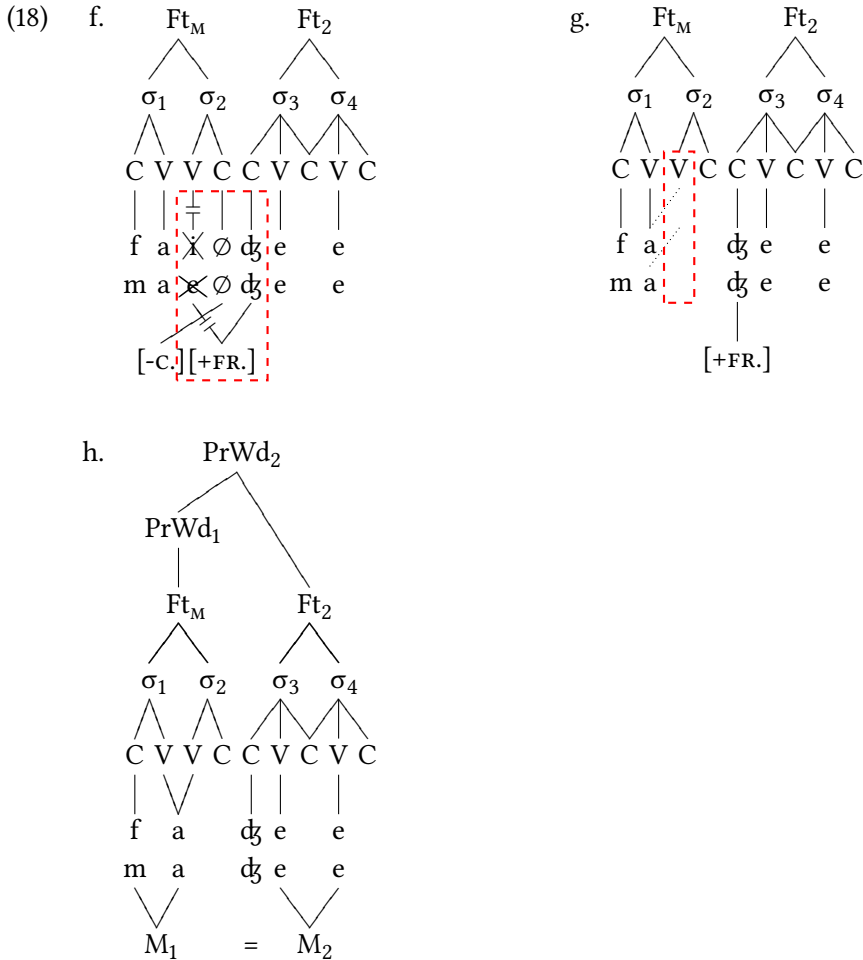

Evidence that both consonant insertion *and* metathesis are required for vowel assimilation comes from the process of consonant insertion in the variety of Kotos Amarasi spoken in Fo'asa' hamlet. As discussed in §5.5.2 below, in Fo'asa' hamlet consonant insertion before enclitics is not conditioned by vowel features spreading; instead a default consonant /g/ is simply inserted. When metathesis then takes place, vowel assimilation does not occur. One example is Fo'asa' *umi* → *uimg=ee* 'house'.

In Nai'bais Amfo'an, vowel assimilation does not occur after consonant insertion for words which end in a vowel sequence. Culhane (2018: 32) gives many examples including *ai* + =ees → *aidʒ=ees* 'one fire', and *hau* + =ees → *haugw=ees* 'one tree'. However, vowel assimilation *does* occur for CV# final words. Examples

include *uki* + =ees → *uukɟ=ees* ‘one banana’ and *nefo* + =ees → *nefgw=ees* ‘one lake’ (Culhane 2018: 32).

This Amfo'an data provides evidence *against* my analysis of vowel assimilation in Amarasi words with a final vowel sequence being due to metathesis of an intervening empty C-slot. However, it is possible to posit that in Amfo'an intervening empty C-slots do not trigger de-linking of vowel features, or that words with a surface final vowel sequence do not undergo metathesis before vowel-initial enclitics.

5.4.1 Clitic hosts with final VVCV#

After words which end in VVCV# (§3.4.1.1), consonant insertion is triggered, but vowel assimilation does not take place. Examples are given in (19) below.

(19) ...V₁V₂C₁V_{3α} → ...V₁V₂C₁C_α=

U-form	M-form	
<i>aunu</i>	→ <i>aungw=ee</i>	‘spear’
<i>n-aiti</i>	→ <i>n-aitɟ=ee</i>	‘picks it up’
<i>n-eiti</i>	→ <i>n-eitɟ=een</i>	‘has travelled’

This is explained by the fact that the first two vowels of such words are assigned to a single V-slot, as illustrated for *n-aiti* → *n-aitɟ=ee* ‘picks it up’ in (20) below. Consonant insertion then occurs in (20a)–(20b) to provide the second foot with an initial consonant.

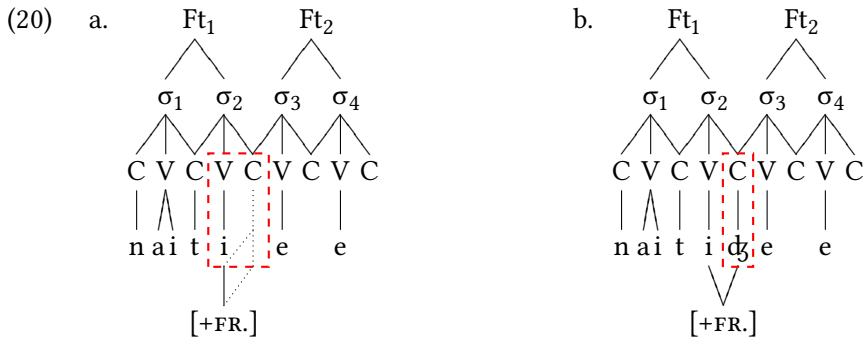

The recently filled C-slot is shared between the internal and external prosodic words, as shown in (20d). Because fuzzy borders are not allowed at prosodic word boundaries, metathesis is triggered, which yields the form in (20e) which has a crisp edge at the prosodic word boundary.

5 Phonologically conditioned metathesis and associated processes

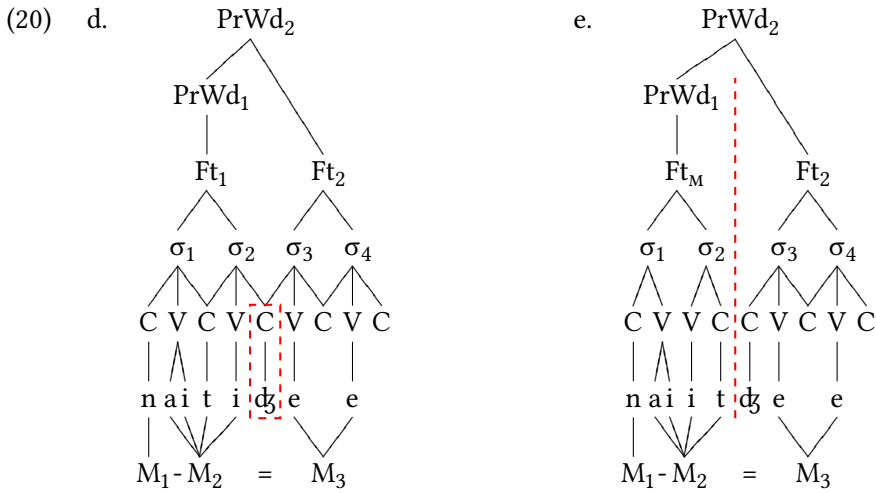

The final vowel of the clitic host then de-links in (20f). This is both because it shares features with /dʒ/ across an intervening C-slot, and because sequences of three vowels are not allowed in Amarasi. After this vowel de-links, the previous vowel spreads into the empty V-slot in (20g), yielding the final output in (20h).

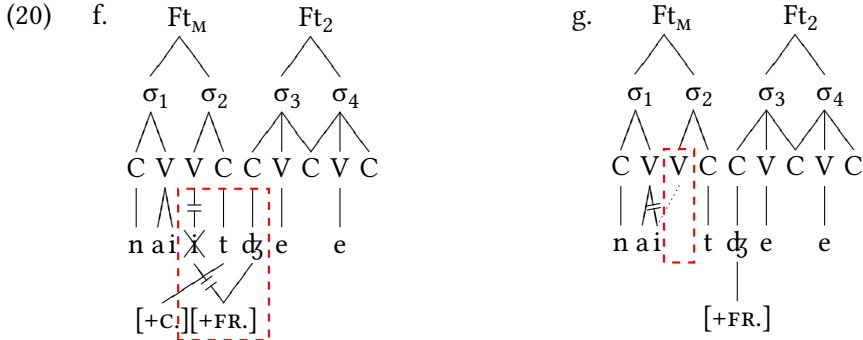

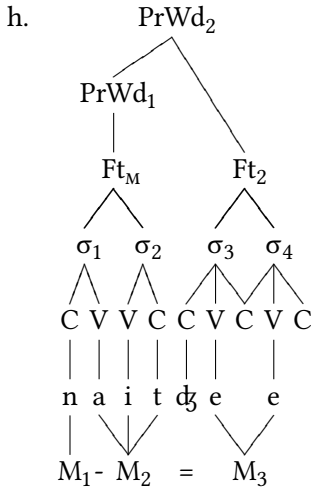

5.5 Clitic hosts with final /a/

When an enclitic attaches to stems which end in the vowel /a/, the clitic host undergoes metathesis and no consonant is inserted. Examples of vowel-initial enclitics attached to stems which end in /Ca/ are given in (21) below.

As discussed in §4.2.2.2, when a word which ends in surface /Ca/ undergoes metathesis, the vowel /a/ undergoes complete assimilation. Assimilation of /a/ in metathesised forms is a derived environment effect and should not be confused with assimilation of vowels after consonant insertion discussed in §5.4 above. Although the results are similar, assimilation of /a/ and assimilation after consonant insertion are triggered by different factors.

(21) $V_\alpha Ca\# + =V \rightarrow V_\alpha V_\alpha C=V$

<i>n-biba</i>	+	=ee	→	<i>n-biib=ee</i>	‘massages her/him’
<i>n-nena</i>	+	=ee	→	<i>n-neen=ee</i>	‘hears it/her/him’
<i>n-paha</i>	+	=ee	→	<i>n-paah=ee</i>	‘splits it’
<i>n-sosa</i>	+	=ee	→	<i>n-soos=ee</i>	‘buys it’
<i>n-suba</i>	+	=ee	→	<i>n-suub=ee</i>	‘buries it/her/him’

The lack of consonant insertion in such examples can be accounted for because the vowel /a/ is featureless regarding the relevant vocalic place features which spread. The vowel /a/ is [-FRONT, -BACK, -ROUND] (§3.2.1). Thus, it can provide no features to fill a following empty C-slot.

5 Phonologically conditioned metathesis and associated processes

The way this works for *n-biba* + =*ee* → *n-biib=ee* ‘massages her/him’ and *n-nena* + =*ee* → *n-neen=ee* ‘hears her/him/it’ is illustrated in (22) below. In (22a) the initial C-slot of the second foot begins is empty. Because feet require an onset, the features of the previous vowel spread. However, the features of /a/ are insufficient to produce a consonant and the onset C-slot of the enclitic remains empty in (22b).

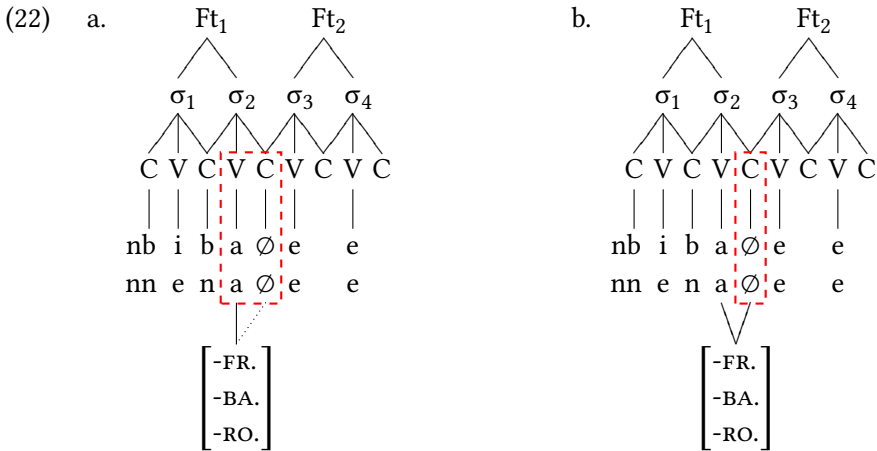

Because this empty C-slot is shared between two prosodic words, as shown in (22d), metathesis is triggered to resolve the fuzzy border. This produces a crisp edge after the internal prosodic word, as illustrated in (22e).

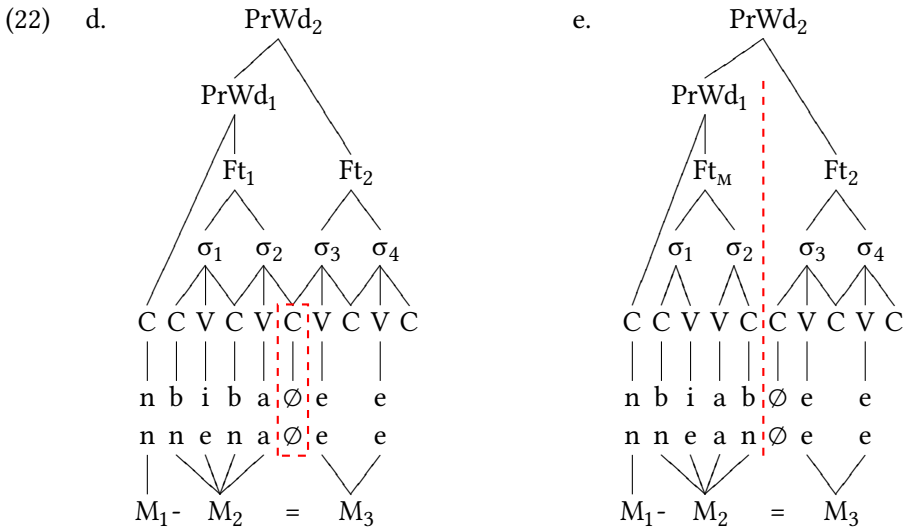

The features of the penultimate vowel of the M-foot (metathesised foot) then spread in (22f) due to the morphemically conditioned rule of /a/ assimilation (§4.3.3). This produces the final outputs with double vowels in (22g).

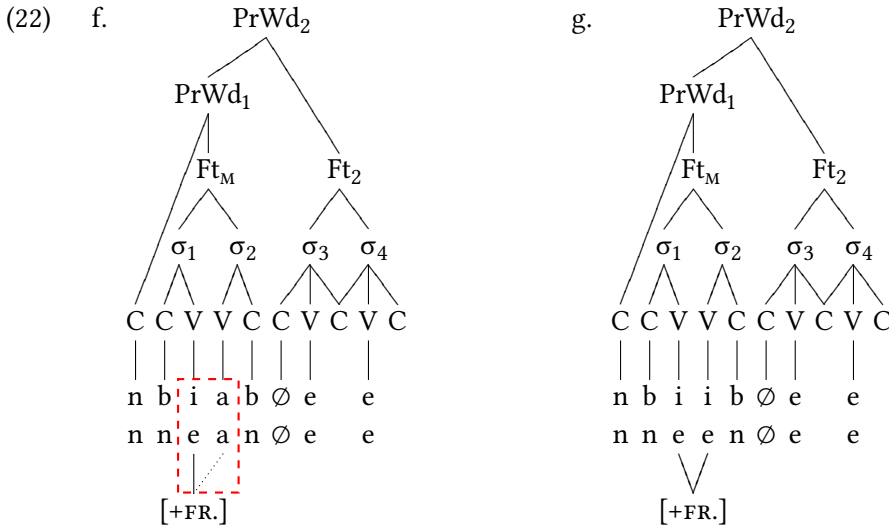

Metathesis before vowel-initial enclitics operates at the consonant-vowel tier. It is blind to the contents of the C-slots and V-slots. Thus, that the C-slot shared between the clitic hosts and enclitic is empty in (22) is irrelevant, or unseen, by the constraint requiring a crisp edge.

Nonetheless, metathesis is still somewhat successful in creating a crisp edge. A word such as *n-biib=ee*, in which the clitic host ends in a surface consonant, arguably has a greater phonological separation between host and enclitic than potential **n-biba=ee* in which the host ends in a surface vowel.

5.5.1 Clitic hosts with final /Va/

After stems which end in *Va#*, /gw/ is inserted, but vowel assimilation does not take place. Examples are given in (23) below.

(23) $Va+V \rightarrow Vagw=V$

<i>mria</i>	+	<i>=een</i>	→	<i>na-mriagw=een</i>	‘fertile, lush’
<i>tea</i>	+	<i>=een</i>	→	<i>n-teagw=een</i>	‘arrived’
<i>haa</i>	+	<i>=een</i>	→	<i>haagw=een</i>	‘four’
<i>tua</i>	+	<i>=ee</i>	→	<i>na-tuagw=ee</i>	‘occupies it’
<i>pentua</i>	+	<i>=ee</i>	→	<i>pentuagw=ee</i>	‘the church elder’

5 Phonologically conditioned metathesis and associated processes

The consonant /gw/ is inserted in this environment to break up the underlying sequence of three vowels. However, the reason /gw/ is inserted rather than /ʔ/ not fully explained in more or less the same way that insertion of /dʒ/ or /gw/ at clitic boundaries is not fully explained (see the discussion on page 218).

Nonetheless, because /gw/ is not inserted in such examples to provide an onset consonant, but rather to break up a sequence of three vowels, identifying it as the default foot-final consonant is probably the best solution. My analysis is illustrated in (24) below, which is followed by a discussion of this analysis and its possible implications.

The underlying structure of *na-tua* + *=ee* → *na-tuagw=ee* ‘occupies it’ is given in (24a). This form has a sequence of three vowels. As a result consonant insertion occurs to resolve this disallowed sequence. Because this C-slot is the final C-slot of the initial foot, the default final consonant /gw/ is inserted in (24b). This C-slot is also shared with the following foot. As a result, metathesis then occurs to resolve the fuzzy border after the internal prosodic word, producing the final output in (24c).

Insertion of /gw/ in (24) and parallel forms occurs primarily to resolve a disallowed sequence of three vowels. However, it also has the added benefit of providing the enclitic with an onset consonant.

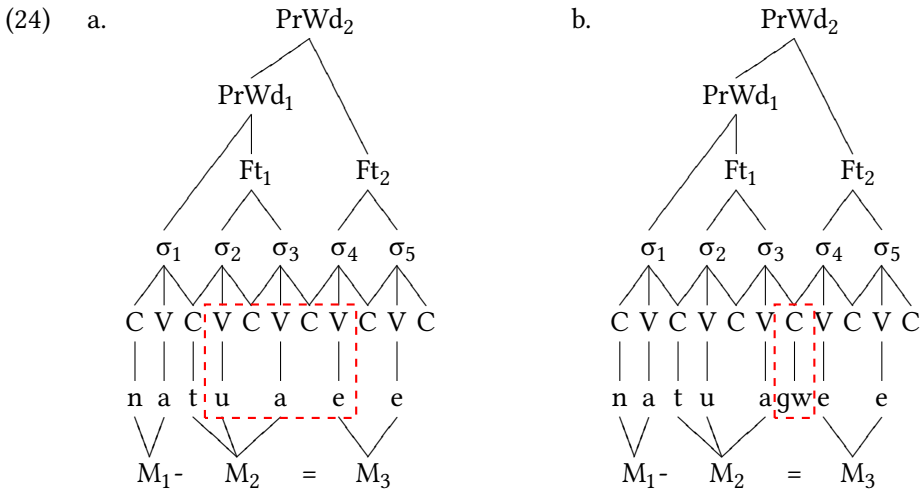

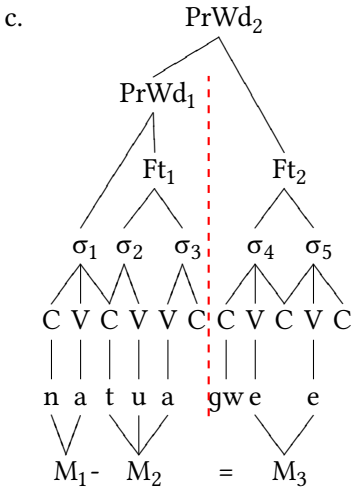

If /gw/ is the default foot-final consonant, as I have proposed, we would expect it to also be inserted after Ca# final words when a vowel-initial enclitic is attached (*n-biib=ee* ‘massages her/him’) in order to provide the enclitic with an onset consonant. The reason this does not occur probably has to do with the motivation for /gw/ insertion in each case.

After Va# final words, such as *na-tuagw=ee* ‘occupies it’, /gw/ is not primarily inserted to provide the enclitic with an onset, but rather to break up the underlying sequence of three vowels. Put another way, lack of an onset consonant after Ca#-final words is better than insertion of /gw/, while the presence of a sequence of three vowels in Va# final words is worse than insertion of /gw/.

However, given the data from the M-forms of VVCV# forms, such as *aunu* → *aun* ‘spear’ and *kauna?* → *kaun* ‘snake; creature’ in which the sequence of three vowels created after metathesis is resolved by vowel deletion (§4.2.4), we might expect the underlying sequence of vowels in examples such as *na-tua=ee* → *na-tuagw=ee* ‘occupies it’ to be similarly resolved by vowel deletion.

The reason this does not occur is because vowel deletion would have to occur twice in order to resolve such sequences as there are four underlying vowels in such forms. One instance of epenthesis is preferred over two instances of deletion.

5.5.2 Fo'asa' consonant insertion

Evidence in favour of analysing /gw/ as a default consonant comes from the variety of Kotos Amarasi spoken in Fo'asa' hamlet, one of the four hamlets unified to form the village of Nekmese' (§1.2). In Fo'asa', when a vowel-initial en-

5 Phonologically conditioned metathesis and associated processes

clitic is attached to a vowel-final stem, a velar obstruent /g/ (without [w]) is inserted. Metathesis also occurs, but does not trigger vowel assimilation. Examples of Fo'asa' consonant insertion are given in (25) below.

(25) Consonant insertion in Fo'asa'

			Fo'asa'	Koro'oto	gloss
<i>umi</i>	+	=ee	→ <i>uimg=ee</i>	<i>uumɔ̃=ee</i>	'the house'
<i>peti</i>	+	=ee	→ <i>peitg=ee</i>	<i>peetɔ̃=ee</i>	'the box'
<i>n-rari</i>	+	=ee	→ <i>n-rairg=ee</i>	<i>n-raardɔ̃=ee</i>	'finishes it'
<i>n-soʔi</i>	+	=ee	→ <i>n-soiʔg=ee</i>	<i>n-sooʔɔ̃=ee</i>	'counts it'
<i>fee</i>	+	=ee	→ <i>feeg=ee</i>	<i>feeɔ̃=ee</i>	'the wife'
<i>n-moʔe</i>	+	=ee	→ <i>n-moeʔg=ee</i>	<i>n-mooʔɔ̃=ee</i>	'does it'
<i>hau</i>	+	=ii	→ <i>haug=ii</i>	<i>haagw=ii</i>	'the tree'
<i>nen</i>	+	=ees	→ <i>neɔ̃g=ees</i>	<i>neɔ̃gw=ees</i>	'one day'

Roots which end in final /a/ have variation between no consonant insertion, or insertion of /g/ in Fo'asa'. Two examples are *na-ʔura* + =een → *na-ʔuurg=een* ~ *na-ʔuur=een* 'it started raining', and *n-sosa* + =ee → *n-soosg=ee* ~ *n-soos=ee* 'buys it'.

In present day Nekmese', this so-called "Fo'asa' ge" also occurs in the speech of those who originally lived in Koro'oto', particularly in certain set phrases. It is also common in the speech of the generation which was born after the creation of Nekmese'. One phrase in which this Fo'asa' ge is common is the phrase used to take leave, given in (26) below.

- (26) Koro'oto: *au ʔ-faanɔ̃=een* *tua*
 Fo'asa': *au ʔ-faing=een* *tua*
 au ʔ-fani=ena *tua*
 1SG 1SG-return\̃=INCEP ADDR
 'I'm going to go back (home) now.'

The process of consonant insertion for Fo'asa' *umi* → *uimg=ee* 'house' is illustrated in (27) below. In (27a) each foot begins with an empty C-slot. As a result, consonants are inserted in (27b). The glottal stop is selected to fill the first empty C-slot as this is the default initial consonant. The velar obstruent is selected to fill the second empty C-slot, as this C-slot is foot final and /g/ is the default final consonant.

Because the third C-slot is shared between two prosodic words, metathesis then occurs to produce a crisp edge after the internal prosodic word, yielding the final output in (27c).

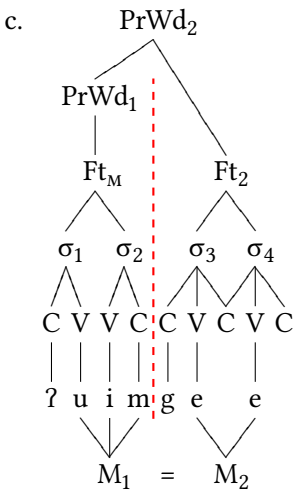
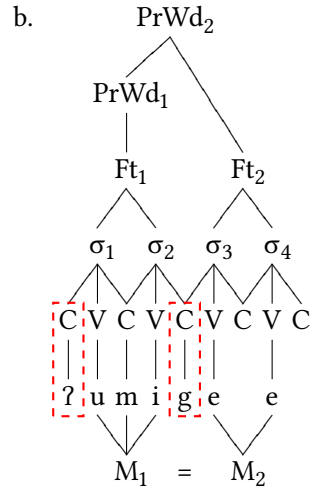
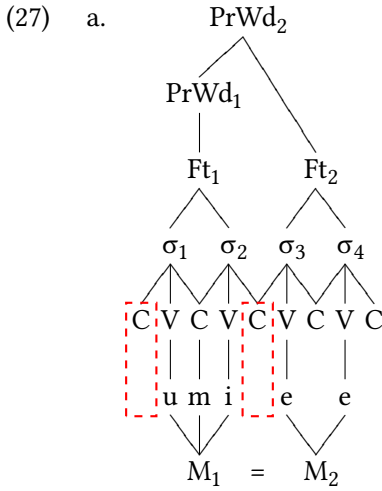

Consonant insertion in Fo'asa' hamlet is different from Koro'oto hamlet in two ways. Firstly, in Fo'asa' the default foot-final consonant is the velar obstruent /g/, while in Koro'oto it is the labio-velar obstruent /gw/.

Secondly, in Koro'oto hamlet word-medial consonant insertion is conditioned by the quality of the previous vowel. In Fo'asa' hamlet, the quality of the previous vowel plays no role, and instead the default final consonant is inserted. Because no features are shared between the inserted consonant and the previous vowel, vowel assimilation is not triggered by metathesis.

5.6 The plural enclitic

The plural enclitic has a number of allomorphs and variant forms, partly depending on the shape of the host to which it attaches. This enclitic marks plurals for nouns and for verbs it marks that one or more of the core verbal arguments (subject or object) is plural. The allomorphy of the plural enclitic for verbs and nouns is similar, though not identical. This allomorphy is summarised in Table 5.3. The main difference is the allomorphs taken by nouns and verbs ending in a vowel sequence.

Table 5.3: Plural enclitic allomorphy

Stem	Nominals	Verbs
...C#	= <i>ein</i> / <i>eni</i> , = <i>enu</i> / <i>uun</i>	= <i>ein</i> / <i>eni</i> , = <i>enu</i> / <i>uun</i>
...CV#	= <i>n</i>	= <i>n</i>
...VV#	= <i>n</i> = <i>gwein</i> , = <i>nu</i>	= <i>n</i>

After consonant-final stems, the plural enclitic usually has the form =*ein*/*eni*. The M-form =*ein* is usually realised as [ɪn], and U-form =*eni* as [ɛni]. The choice between the U-form and M-form of this enclitic is discourse driven (Chapter 7) and the M-form is the default form (§7.3). Before this enclitic CVC# stems undergo metathesis, as is expected before vowel-initial enclitics. Examples of pluralised consonant-final verbs and nouns are given in (28) below.

(28) {PL} → =*ein* /C#_

<i>anah</i>	→	<i>aanh</i> = <i>ein</i>	‘children’
<i>kaes muti?</i>	→	<i>kaes muit?</i> = <i>ein</i>	‘Europeans’
<i>eno?</i>	→	<i>eon?</i> = <i>ein</i>	‘doors’
<i>tuaf</i>	→	<i>tuaf</i> = <i>ein</i>	‘people’
<i>kuan</i>	→	<i>kuan</i> = <i>ein</i>	‘villages’
<i>n-fesat</i>	→	<i>n-feest</i> = <i>ein</i>	‘(they) throw a party’
<i>na-barab</i>	→	<i>na-baarb</i> = <i>ein</i>	‘(they) prepare’
<i>n-?onen</i>	→	<i>n-?oenn</i> = <i>ein</i>	‘(they) pray’
<i>na-tuin</i>	→	<i>na-tuin</i> = <i>ein</i>	‘(they) follow’

This enclitic also has the variant forms =*uun* and =*enu*, of which the form =*uun* is the M-form of =*enu*. The expected M-form *=*eun* does not occur in my

data, thus *=enu* → *=uun* is an irregular M-form (§4.2.5). The forms *=enu* and *=uun* are rare in my data. There are twelve attestations of *=uun* in my corpus and three attestations of *=enu*. This is compared with 157 attestations of *=ein* and 21 attestations of *=eni*. Examples of *=uun* and *=enu* are given in (29) below. The clitic hosts shown in (29) also occur with *=ein*.⁶

(29) {PL} → *=uun* ~ *=enu* /C#_

<i>abas</i>	→	<i>aabs=uun</i>	‘threads’
<i>na-ʔkoroʔ</i>	→	<i>na-ʔkooʔ=uun</i>	‘(they) hide’
<i>Timor</i>	→	<i>Tiamr=uun</i>	‘Timorese people’
<i>faif anaʔ</i>	→	<i>faif aanʔ=enu</i>	‘piglets’
<i>kana-k</i>	→	<i>kaan-k=enu</i>	‘their names’

After stems which end in CV, the plural enclitic usually takes the form *=n*. Examples are given in (30) below.

(30) {PL} → *=n* /CV#_

<i>kase</i>	→	<i>kase=n</i>	‘foreigners’
<i>hutu</i>	→	<i>hutu=n</i>	‘head-lice’
<i>kbiti</i>	→	<i>kbiti=n</i>	‘scorpions’
<i>koro</i>	→	<i>koro=n</i>	‘birds’
<i>tuni</i>	→	<i>tuni=n</i>	‘eels’
<i>n-moʔe</i>	→	<i>n-moʔe=n</i>	‘(they) do/make’
<i>na-tona</i>	→	<i>na-tona=n</i>	‘(they) tell’
<i>n-eki</i>	→	<i>n-eki=n</i>	‘(they) bring’
<i>na-hana</i>	→	<i>na-hana=n</i>	‘(they) cook’

Similarly, after verbs which end in a vowel sequence, the plural enclitic also has the form *=n*. A number of examples are given in (31) below.

(31) {PL} → *=n* Verb, /VV#_

<i>n-sii</i>	→	<i>n-sii=n</i>	‘(they) sing’
<i>n-murai</i>	→	<i>n-murai=n</i>	‘(they) start’
<i>n-tui</i>	→	<i>n-tui=n</i>	‘(they) write’
<i>n-kae</i>	→	<i>n-kae=n</i>	‘(they) cry’
<i>n-nao</i>	→	<i>n-nao=n</i>	‘(they) go’
<i>na-niu</i>	→	<i>na-niu=n</i>	‘(they) bathe’
<i>na-mnau</i>	→	<i>na-mnau=n</i>	‘(they) remember’
<i>n-poi</i>	→	<i>n-poi=n</i>	‘(they) exit/go out’

⁶In some varieties of Amanuban the plural enclitic usually has the form *=enu/=eun*.

5 Phonologically conditioned metathesis and associated processes

When nouns which end in a vowel sequence are pluralised, a number of different forms occur. Firstly, there is the form =*nu* which I have encountered once as a simple plural during my fieldwork. This example is given in (32) below.

- (32) *hiit t-hormaat hau=nu!*
 1PI 1PI-honour tree=PL
 ‘We’re giving honour to the trees!’ (Joke made when ducking branches of trees while riding in the back of a truck.) Observation 06/10/14

The clitic =*nu* also attaches to VV# final pronouns to mark an otherwise unexpressed plural possessum. Thus, *au=nu* ‘mine/my things’, *hoo=nu* ‘yours/your (sg.) things’, *hai=nu* ‘ours (excl.)/our things’, *hii=nu* ‘yours (pl.)/your things’. See §6.4.1 for more discussion.

However, the normal way in which VV# final nouns mark plural and the normal way VV# final pronouns mark plural possessums is with a form [ŋgwɪn]. This is analysable as a combination of =*nu* + =*ein* with insertion of /gw/ before the second enclitic. Examples with are given in (33) below.⁷

- (33) {PL} → =*ŋgwein* /VV#_
- | | | | |
|---------------|---|----------------------|---------------------------|
| <i>bifēe</i> | → | <i>bifēe=ŋgwein</i> | ‘women’ |
| <i>biɟʌe</i> | → | <i>biɟʌe=ŋgwein</i> | ‘cows’ |
| <i>oe</i> | → | <i>oe=ŋgwein</i> | ‘kinds of water’ |
| <i>pentua</i> | → | <i>pentua=ŋgwein</i> | ‘church elders’ |
| <i>too</i> | → | <i>too=ŋgwein</i> | ‘citizens’ |
| <i>hau</i> | → | <i>hau=ŋgwein</i> | ‘trees’ |
| <i>au</i> | → | <i>au=ŋgwein</i> | ‘mine/my things’ |
| <i>hoo</i> | → | <i>hoo=ŋgwein</i> | ‘yours (sg.)/your things’ |
| <i>hai</i> | → | <i>hai=ŋgwein</i> | ‘ours (excl.)/our things’ |
| <i>hii</i> | → | <i>hii=ŋgwein</i> | ‘yours (pl.)/your things’ |

The noun *kfuu* ‘star’ is an exception. This word has the plural form *kfuu=n* ‘stars’ for some speakers. In this case singular *kfuu* ‘star’ is a back formation, as the final /n/ of plural *kfuu=n* is a reflex of the final consonant of Proto-Malayo-Polynesian *bituqən. Similarly, while the loan word *partei* ‘friend’ (from Dutch

⁷In the Baikeno variety of Meto the plural enclitic has the form =*mbini* after words which end in a vowel sequence, e.g. *biɟʌe=mbini* ‘cows’. Insertion of Baikeno /b/ also corresponds to insertion of Amarasi /gw/ in other environments.

partij [partei]) usually has the plural *partei=ηgwein* ‘friends’, it has been attested once with =*n*; thus *partei=n* ‘friends’ (Ora 2016a: 3).⁸

There are also three examples in which a CV# or C# final noun takes double plural marking with both =*n* and =*ein*, given in (34)–(36) below.

- (34) *feʔe n-ʔoban naan rauk=n=ein, nopu nua mes*
feʔe n-ʔoban naan raku=n=ein nopu nua mes
 earlier 3-furrow 2DEM sweet.potato=PL=PL hole two but
ka= n-eku =f, n-ʔoobn=aah.
ka= n-eku =f, n-ʔoban=aah.
 NEG= 3-eat =NEG 3-furrow=just
 ‘Earlier it had dug up the sweet potatoes, there were two holes but it hadn’t eaten anything, it just dug around.’ 130914-2, 1.17 🔊

- (35) *hoo m-fee areʔ kana=n hau fua-f maut*
hoo m-fee areʔ kana=n hau fua-f maut
 2SG 1PX/2-give every name=PL tree fruit-0GEN let
he koor=n=ein bisa n-eku=n.
he koro=n=ein bisa n-eku=n.
 IRR bird=PL=PL can 3-eat=PL
 ‘You gave all kinds of fruit trees in order that all the different birds could eat.’ (Ora 2016b: 11)

- (36) *rari =te, n-ma-taeb n-ok ahh baroit=n=eni =ma*
rari =te, n-ma-tabe n-oka baroit=n=eni =ma
 finish =SUB 3-RECP-shake.hands 3-with bride/groom=PL=PL =and
 ‘After that he shook hands with both the bride and groom and’ 130902-1, 3.28 🔊

Despite the complexities in the data, the forms of the plural enclitic(s) can be mostly described as allomorphy, as summarised in Table 5.3. For verbs the analysis is a straightforward case of phonologically conditioned allomorphy. Vowel-final stems take =*n* while consonant-final stems take =*ein*/=*eni*, or its variant =*uun*/=*enu*. For nouns the data is more complex. Consonant-final nouns take =*ein*/=*eni*, CV# final nouns take =*n*, and VV# final nouns normally take =*ηgwein* (analysable as =*nu* + =*ein*) but also are attested with =*n* or =*nu*. Double plural marking with =*n=ein* also occasionally occurs with nouns.

⁸Another allomorph for VV# final nouns is =*ηgonu*/=*ηgoun* which is attested from a single speaker, and then only on the loan *oraŋ tua* ‘parents’ (from Malay *orang tua*). There is one example each in my data of *oraŋ tua=ηgonu* and *oraŋ tua=ηgoun* ‘parents’.

The examples with double plural marking may indicate that the different allomorphs have come from different sources and may have once been different morphemes with different functions. While there may be traces of these different functions in some of the synchronic data, in most cases, and for most speakers, they appear to have semantically merged and both mark plural.⁹

That the vowel-initial forms of the plural enclitic *=ein* do not occur with vowel-final stems means that consonant insertion is not usually observed before this enclitic. There is one exception in my database: the verb *na-ʔbaʔe* ‘play’, which has been attested once with the plural enclitic allomorph *=ein* as *na-ʔbaaʔɕʔ=ein*. This verb is also exceptional in not otherwise taking M-forms.¹⁰

5.6.1 Consonant insertion after =n

When the *=n* allomorph of the plural enclitic attaches to a stem which ends in a vowel sequence, any subsequent clitic triggers insertion of /gw/. This is analysable as resulting from historic/underlying *=nu*.

Such consonant insertion does not occur when *=n* attaches to a CV# final stem. Instead, when a vowel-initial enclitic follows, the host is treated like a CVC# stem with regular metathesis. Examples are given in (37) below.

(37) CV=*n* + =V → VC=*n*=V

<i>sepatu</i>	+	<i>=n</i>	+	<i>=ii</i>	→	<i>sepaut=n=ii</i>	‘the shoes’
<i>hutu</i>	+	<i>=n</i>	+	<i>=aan</i>	→	<i>huut=n=aan</i>	‘the head-lice’
<i>kase</i>	+	<i>=n</i>	+	<i>=ee</i>	→	<i>kaes=n=ee</i>	‘the foreigners’
<i>kbiti</i>	+	<i>=n</i>	+	<i>=ee</i>	→	<i>kbiit=n=ee</i>	‘the scorpions’
<i>koro</i>	+	<i>=n</i>	+	<i>=ee</i>	→	<i>koor=n=ee</i>	‘the birds’
<i>fafi</i>	+	<i>=n</i>	+	<i>=ee</i>	→	<i>faif=n=ee</i>	‘the pigs’
<i>n-toti</i>	+	<i>=n</i>	+	<i>=aah</i>	→	<i>n-toit=n=aah</i>	‘(they) just ask’
<i>n-hera</i>	+	<i>=n</i>	+	<i>=ee</i>	→	<i>n-heer=n=ee</i>	‘(they) pull it’
<i>n-fani</i>	+	<i>=n</i>	+	<i>=een</i>	→	<i>n-fain=n=een</i>	‘(they’ve) now returned’
<i>na-hini</i>	+	<i>=n</i>	+	<i>=ii</i>	→	<i>na-hiin=n=een</i>	‘(they) now know’

As discussed above, the regular allomorph of the plural enclitic on VV# verbs is *=n*. When either of the enclitics *=een* or *=aah* follows, /gw/ usually occurs before the second enclitic. Examples are given in (38) below.

⁹The allomorph *=n* may have originally marked plurals with an emphasis on the group as a collection of individuals, thus paralleling the use of the quantifier *areʔ* ‘every, all’ while *=ein* marked plurals as a whole mass, thus paralleling the use of the quantifier *okeʔ* ‘all’.

¹⁰There are also three other vowel-final stems occurring with the enclitic *=ein* in the Amarasi Bible translation: *na-ʔtaʔi* ‘trembles’ + *=ein* → *<na'tai'jein>* (one example), *koʔu* ‘big’ + *=ein* → *<kou'guin>* (five examples) and *na-ʔseʔ-seʔo* ‘whispers’ → *<na'se'-seo'guin>* (two examples).

(38) $VV + =n + =V \rightarrow VV=\eta gwV$

<i>n-sii</i>	+	<i>=n</i>	+	<i>=een</i>	\rightarrow	<i>n-sii=\eta gw=e</i>	‘(they’ve) now sung’
<i>n-murai</i>	+	<i>=n</i>	+	<i>=een</i>	\rightarrow	<i>n-murai=\eta gw=e</i>	‘(they’ve) now started’
<i>n-tui</i>	+	<i>=n</i>	+	<i>=een</i>	\rightarrow	<i>n-tui=\eta gw=e</i>	‘(they’ve) now written’
<i>n-kae</i>	+	<i>=n</i>	+	<i>=een</i>	\rightarrow	<i>n-kae=\eta gw=e</i>	‘(they’ve) now cried’
<i>n-tea</i>	+	<i>=n</i>	+	<i>=een</i>	\rightarrow	<i>n-tea=\eta gw=e</i>	‘(they’ve) now arrived’
<i>na-bua</i>	+	<i>=n</i>	+	<i>=een</i>	\rightarrow	<i>na-bua=\eta gw=e</i>	‘(they’ve) now gathered’
<i>n-nao</i>	+	<i>=n</i>	+	<i>=een</i>	\rightarrow	<i>n-nao=\eta gw=e</i>	‘(they’ve) now gone’
<i>na-niu</i>	+	<i>=n</i>	+	<i>=een</i>	\rightarrow	<i>na-niu=\eta gw=e</i>	‘(they’ve) now bathed’
<i>n-poi</i>	+	<i>=n</i>	+	<i>=aah</i>	\rightarrow	<i>n-poi=\eta gw=aah</i>	‘(they) just went out’

Such insertion of /gw/ does not occur for verbs before other enclitics. There are five examples in my corpus, two with the discourse marker =*ii* and three with the 3SG.ACC pronoun =*ee*. These examples are given in (39) below.¹¹

(39) $VV + =n + =ee/=ii \rightarrow VV=n=ee/=ii$

<i>na-ʔ-rau=n</i>	+	<i>=ii</i>	\rightarrow	<i>na-ʔ-rau=n=ii</i>
3-TR-bite=PL		1DET		‘made these ones bite’
<i>m-foe~foe=n</i>	+	<i>=ii</i>	\rightarrow	<i>m-foe~foe=n=ii</i>
1PX/2-FRD~move=PL		1DET		‘(we’ve) worked hard’
<i>n-nao=n</i>	+	<i>=ee</i>	\rightarrow	<i>n-nao=n=ee</i>
3-go=PL		3SG.ACC		‘went to him/her’
<i>n-sae=n</i>	+	<i>=ee</i>	\rightarrow	<i>n-sae=n=ee</i>
3-go.up=PL		3SG.ACC		‘increased for him/her’
<i>t-fee=n</i>	+	<i>=ee=siin</i>	\rightarrow	<i>t-fee=n=ee=siin</i>
1PI-give =PL		3SG.ACC=3PL		‘gave it to them’

When a combination of a plural enclitic and a vowel-initial enclitic occur on a VV# noun, the plural enclitic takes the form =*n* with insertion of /gw/ before the second enclitic. For nouns, this includes enclitics other than =*een* and =*aah*. Examples are given in (40) below.

(40) $VV + =n + =V \rightarrow VV=\eta gw=V$

<i>oe=n</i>	+	<i>=aan</i>	\rightarrow	<i>oe=\eta gw=aan</i>	‘the kinds of water’
<i>mei=n</i>	+	<i>=ee</i>	\rightarrow	<i>mei=\eta gw=ee</i>	‘the tables’
<i>too=n</i>	+	<i>=ii</i>	\rightarrow	<i>too=\eta gw=ii</i>	‘the citizens’

¹¹There is also one example in my corpus of =*n* + =*ein* on a VV# final host without consonant insertion: *n-tea=n=ein* ‘they’ve arrived’.

5 Phonologically conditioned metathesis and associated processes

Examples of $=n$ and another enclitic are judged as ungrammatical without insertion of /gw/. Two examples are $*n-sii=n=een$ ‘sung’ and $*n-kae=n=een$ ‘cried’. This creates near-minimal pairs between forms in which a final /n/ is part of the root and ones in which it is the plural enclitic. Thus, $n-sii=n + =een \rightarrow n-sii=\eta gw=een$ ‘they’ve sung’ can be compared with $n-pina + =een \rightarrow n-piin=een$ ‘blazed’.

Similarly, among nouns, insertion of /gw/ occurs after plural $=n$, but not after the 3SG.GEN suffix $-n$. Thus $too=\eta gw=ee$ ‘citizen=PL=3DET’ (‘the citizens’) with insertion of /gw/ can be compared with $ao-n=ee$ ‘body-3SG.GEN=3DET’ (‘someone’s body’) without insertion.

When the $=n$ allomorph of the plural enclitic attaches to a stem which ends in a vowel sequence, any subsequent clitic usually triggers insertion of /gw/. This is regular for nouns before all vowel-initial enclitics and regular for verbs before $=een$ ‘INCEP’ and $=aah$ ‘just’.

5.6.2 Analysis of /gw/ insertion after $VV=n$

Insertion of /gw/ after $=n$ can be analysed by positing metathesis of underlying (or historic) $=nu$. While rare, this form *is* attested without any following enclitic. I propose that this is (or was) the allomorph of this enclitic taken by words which end in a vowel sequence.¹²

The full analysis is illustrated in (41) below for too ‘citizen’ + $=nu$ ‘PL’ + $=ii$ ‘1DET’ $\rightarrow too=\eta gw=ii$ ‘the citizens’. The first step is for the enclitic $=nu$ to be attached, as illustrated in (41a). Because this enclitic is a single syllable, it is directly linked to the prosodic word containing the host, in the same way pre-foot material in words greater than two syllables is directly linked to the prosodic word (§3.3.3). The second enclitic is then attached, as shown in (41b), which also shows that the foot containing this second enclitic begins with an empty C-slot.

¹²Evidence that this enclitic consists of only a single syllable comes from its likely etymon: PAN $*-nu$ ‘marker of uncertainty’ (Blust & Trussel ongoing) or $*nu$ ‘genitive marker’ (Wolff 2010: 914). One use of this suffix that has been reconstructed is as place-holder for an unexpressed possessum, such as in $*a-nu-ku$ ‘my unnamed thing: mine’ (Blust & Trussel ongoing). This reconstructed function matches almost exactly use of $=nu$ seen in phrases such as $au=nu$ ‘my things, mine’. See §6.4.1 for more details on this construction.

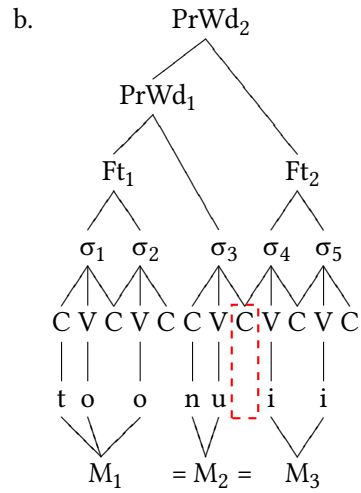
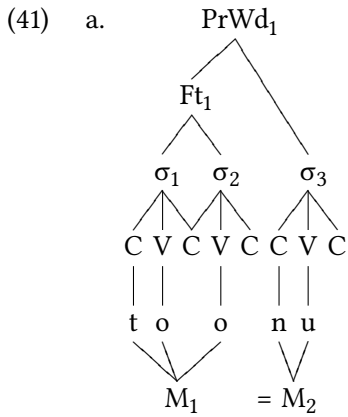

In order to provide the second foot with an onset, the features of the previous vowel spread in (41c), in which the features [+BACK] and [+ROUND] of the vowel /u/ are abbreviated to [+v.]. This produces the obstruent /gw/ as the onset of the second foot in (41d).

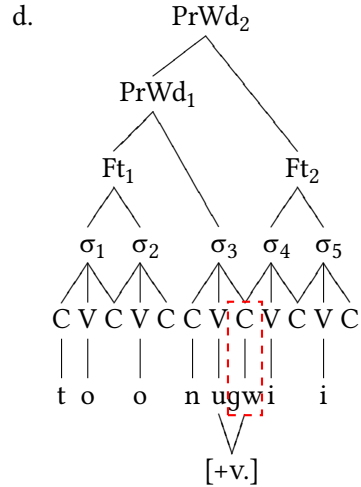
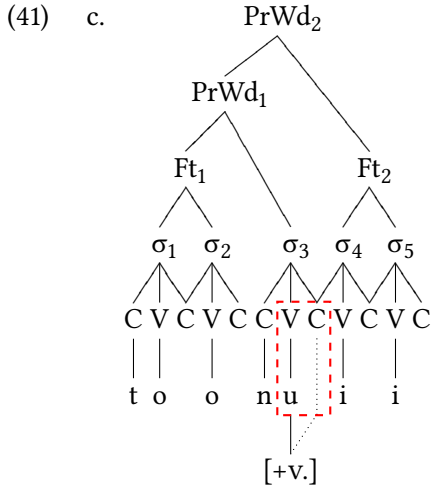

Because the C-slot containing the newly-inserted consonant is shared between the internal and external prosodic word, metathesis occurs in (41e) to create a crisp edge after the internal prosodic word, as shown in (41f).

5 Phonologically conditioned metathesis and associated processes

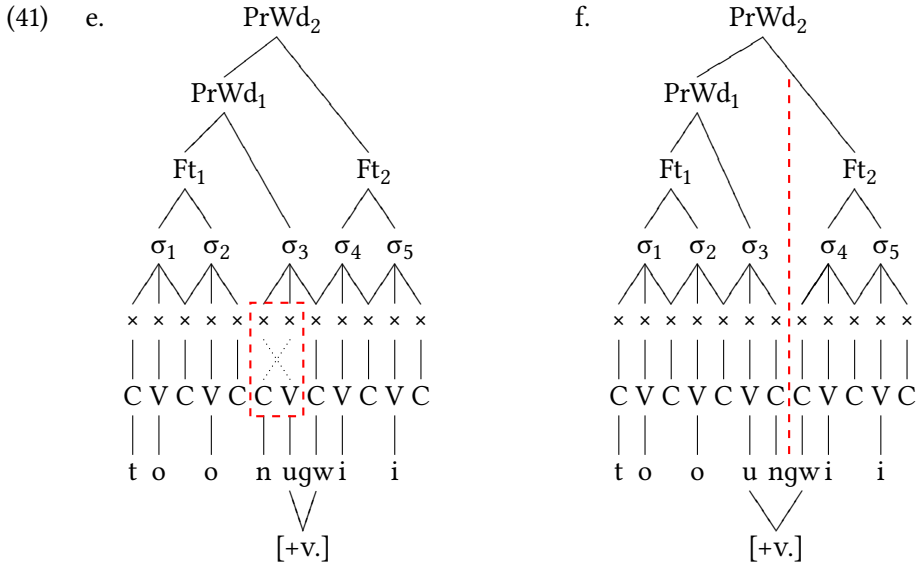

However, metathesis results in the features of final vowel of =nu and the inserted consonant /gw/ being shared across an intervening consonant, as shown in (41g). As a result the vowel de-links. This results in the third syllable having an empty V-slot. Amarasi allows empty C-slots, but not empty V-slots. Normally empty V-slots are filled by spreading of an adjacent vowel, as discussed in §4.2.2. However, there is no adjacent vowel in (41h). Thus, this V-slot is deleted.

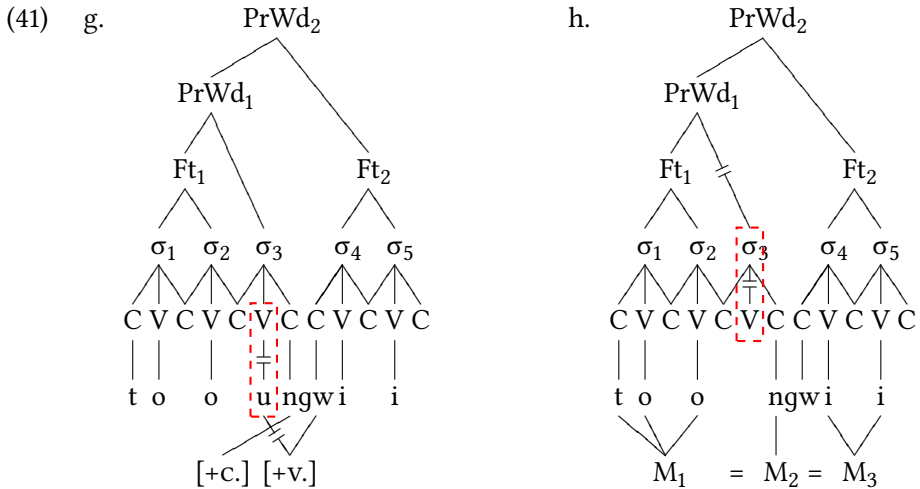

This produces a structure in which the second syllable contains a final cluster in (41i). Normally final clusters are resolved by deletion of the final C-slot of the cluster, as seen in the derivation M-forms (§4.2.3.1). However, in this case the final C-slot contains all that is left of the plural morpheme. I propose that the preservation of this morpheme motivates deletion of the penultimate C-slot (41i) instead. This produces the final output, given in (41j).

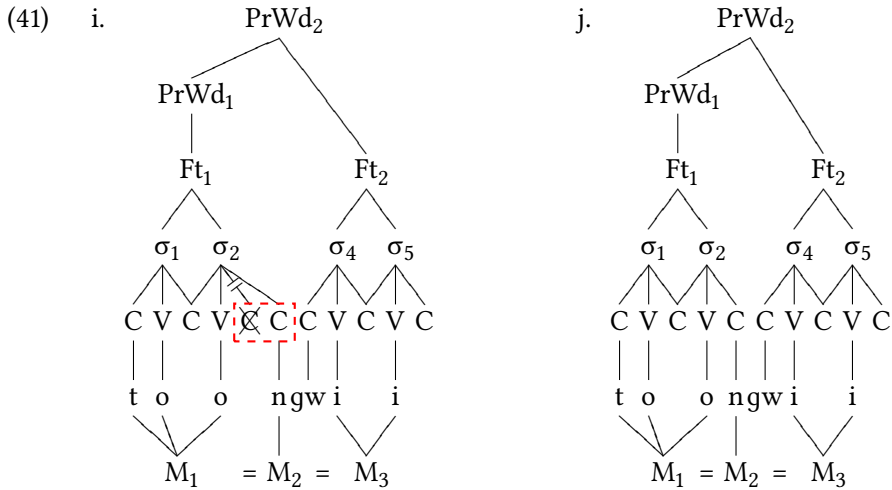

Under this analysis it is only nominal stems ending in a surface vowel sequence which take (or took) the allomorph *=nu*. When another enclitic is then added, the process illustrated in (41a)–(41j) above occurs.

Similarly, for verbs a historic trace of the allomorph *=nu* is only preserved on VV# final stems when the enclitics *=een* or *=aah* are attached. Other vowel-final verbs take the allomorph *=n*.

Nominal stems ending in CV# on the other hand, take the allomorph *=n*, which simply fills the final C-slot, as illustrated for *kase=n* ‘foreigners’ in (42) below. When a vowel-initial enclitic is added, such stems then undergo metathesis. The structure of *kaes=n=ee* ‘the foreigners’ is shown in (43) below to illustrate.

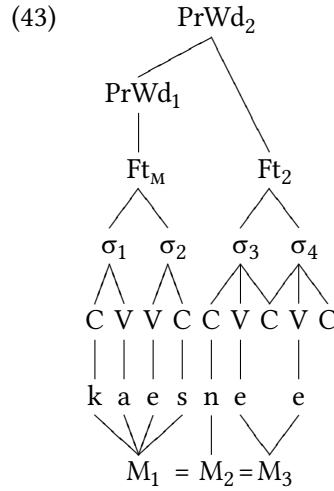
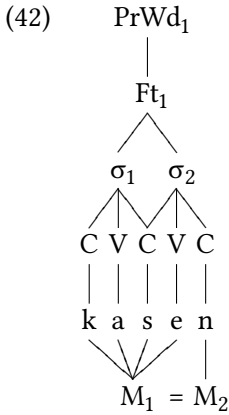

The remaining piece of the puzzle is the observation that, in the vast majority of my data, nouns (but not verbs) which end in a surface vowel sequence are pluralised with a double marking of the plural: =nu + =ein → =ηgwein. The reason for this double plural marking is unexplained. Examples from page 236 are repeated in (44) below.

(44) {PL} → =ηgwein Nominal, /VV#_

<i>bifee</i>	→	<i>bifee=ηgwein</i>	‘women’
<i>biɕʌe</i>	→	<i>biɕʌe=ηgwein</i>	‘cows’
<i>oe</i>	→	<i>oe=ηgwein</i>	‘kinds of water’
<i>pentua</i>	→	<i>pentua=ηgwein</i>	‘church elders’
<i>too</i>	→	<i>too=ηgwein</i>	‘citizens’
<i>hau</i>	→	<i>hau=ηgwein</i>	‘trees’

5.7 Multiple enclitics

Amarasi allows sequences of enclitics to occur. When the second enclitic is vowel-initial, it usually triggers the normal processes of metathesis and consonant insertion on the previous enclitic, though there are some exceptions.

A number of examples of =een ‘INCEP’ attached to =ee ‘3DET/3SG.ACC’ are given in (45) below. All these examples show expected insertion of /dʒ/ before =een as conditioned by the final vowel of =ee.¹³

¹³There is one example in my corpus in which /gw/ is irregularly inserted after =ee. This is *hai mi-ʔuab=eegw=een* ‘we’ve already spoken about it’ (1PX 1PX/2PL-speak=3DET=INCEP).

(45) =ee + =een → =eedʒ=een

<i>na-sopu</i>	+ =ee + =een →	<i>na-soopgw=eedʒ=een</i>	‘finished it’
<i>buku</i>	+ =ee + =een →	<i>buukgw=eedʒ=een</i>	‘the book (already)’
<i>mepu</i>	+ =ee + =een →	<i>meepgw=eedʒ=een</i>	‘the work (already)’
<i>na-kрати?</i>	+ =ee + =een →	<i>na-krait?=eedʒ=een</i>	‘destroyed it’
<i>n-porin</i>	+ =ee + =een →	<i>n-poirn=eedʒ=een</i>	‘threw it’
<i>n-isa</i>	+ =ee + =een →	<i>n-iis=eedʒ=een</i>	‘defeated him’
<i>?sobe?</i>	+ =ee + =een →	<i>?soeb?=eedʒ=een</i>	‘the hat (already)’

In such examples the metathesis of the penultimate clitic is not detectable as the first clitic has a sequence of two identical vowels. Examples of vowel-initial enclitics attached to pronominal enclitics showing vowel assimilation are given in (46) and (47) below.

- (46) *n-aan=kaagw=ii onai, pak*
n-ana=kau=ii onai pak
 3-get=1SG.ACC=1DET like.this dad
 ‘S/he got me like this, dad.’ 130825-7, 0.11 🔊
- (47) *a|n-koleŋ=kaaʒ=ena =m he t-pasan re? ?futu?*
n-koleŋ=kai=ena =ma he t-pasan re? ?futu?
 3-call=1PX.ACC=INCEP =and IRR 1PI-tie TOP belt
 ‘They started calling (to) us to tie the seatbelt.’ 130825-6, 19.24 🔊

Under the analysis of vowel assimilation given in §4.2.2, the assimilation of the final vowels of =*kau* ‘1SG.ACC’ → =*kaagw* and =*kai* → =*kaaʒ* ‘1PX.ACC’ in such examples is due to metathesis of the medial empty C-slot. Similarly, as discussed in §5.3, the insertion of the consonant in all such examples occurs to provide the following foot with an onset consonant.

That consonant insertion and metathesis affect enclitics when an additional enclitic is added has exactly the same explanation as that for every other clitic host. Phrases such as *n-aan=kaagw=ii* ‘got me’ or *meepgw=eedʒ=een* ‘the work (already)’ both have two internal prosodic words, with a crisp edge required after each. The phonological and morphological structures of *meepgw=eedʒ=een* ‘the work (already)’ are shown in (48) below with the crisp edges indicated.¹⁴

¹⁴The use of the M-form for the enclitic =*ena*=*een* ‘INCEP’ in (48) is due to discourse structures, as discussed in Chapter 7

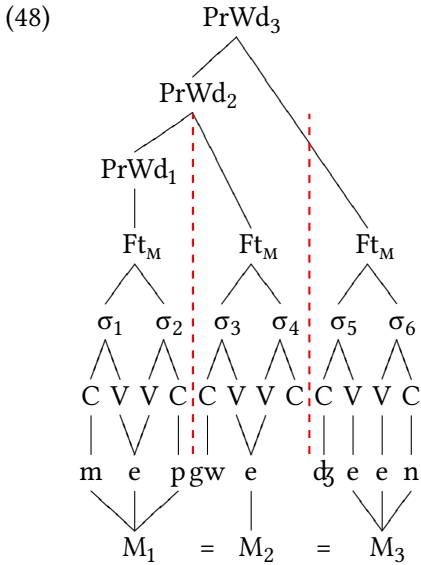

While the normal process occurs in most cases when a second vowel-initial enclitic is added, there are a small number of exceptions. The first exception is insertion of /gw/ when an enclitic attaches to an enclitic which has already triggered insertion of /dʒ/.

Examples are scarce. I have located only four in Ora (2016c) and nine in the Amarasī Bible translation, yielding the five unique examples given in (49) below. Nonetheless, native speakers reject forms with two insertions of /dʒ/ as ungrammatical, thus **oodʒ=eedʒ=een* ‘the water already’ or **n-raardʒ=eedʒ=een*. There is, however, a single example in my corpus: *n-heekdʒ=eedʒ=een* ‘caught it already’.

(49) *dʒ=ee + =een* → *dʒ=eegw=een*

<i>oe</i>	+ =ee + =een	→	<i>oodʒ=eegw=een</i>	‘the water (already)’
<i>ʔ-piri</i>	+ =ee + =een	→	<i>ʔ-piirdʒ=eegw=een</i>	‘(I’ve) chosen him’
<i>n-moʔe</i>	+ =ee + =een	→	<i>n-mooʔdʒ=eegw=een</i>	‘(s/he’s) made it’
<i>ʔ-eki</i>	+ =ee + =een	→	<i>ʔ-ekdʒ=eegw=een</i>	‘(I’ve) brought him’
<i>n-rari</i>	+ =ee + =een	→	<i>n-raardʒ=eegw=een</i>	‘finished it’

Insertion of /gw/ after insertion of /dʒ/ is probably a kind of dissimilation. After /dʒ/ has been inserted, insertion of a second /dʒ/ is blocked. Thus, the default medial consonant /gw/ is inserted at the second clitic boundary.

Another possible case of dissimilatory consonant insertion occurs when the inceptive enclitic =*een* occurs attached to the Indonesian loanword *estiga* ‘PhD,

doctoral degree'.¹⁵ In this case the consonant /dʒ/ is inserted, perhaps due to the presence of [g] in the clitic host and/or the penultimate vowel being /i/. I heard this phrase not infrequently during my fieldwork after explaining I was learning Amarasi for my PhD. It is given in (50) below.

- (50) *estiga*dʒ=*een*
 PhD=INCEP
 '(So, you're) now doing a PhD?' observation

The second exception involving multiple enclitics is when an enclitic attaches to the plural enclitic =*eni*=*ein*, or the pronominal enclitics =*kiti*=*kiit* '1PL.ACC', or =*sini*=*siin* '3PL'. These enclitics occur in the M-form before another enclitic, but consonant insertion does not usually occur. Examples are given in (51) below.

- (51) No consonant insertion after =*ein*, =*kiit* and =*siin*

<i>anah</i>	+	= <i>ein</i>	+	= <i>aa</i>	→	<i>aanh</i> = <i>ein</i> = <i>aa</i>	'the children'
<i>bare?</i>	+	= <i>ein</i>	+	= <i>ee</i>	→	<i>baer?</i> = <i>ein</i> = <i>ee</i>	'the stuff'
<i>upu-?</i>	+	= <i>ein</i>	+	= <i>ee</i>	→	<i>uup-?</i> = <i>ein</i> = <i>ee</i>	'the grandchildren'
<i>papa?</i>	+	= <i>ein</i>	+	= <i>ii</i>	→	<i>paap?</i> = <i>ein</i> = <i>ii</i>	'the wounds'
<i>neka-m</i>	+	= <i>ein</i>	+	= <i>ii</i>	→	<i>neek-m</i> = <i>ein</i> = <i>ii</i>	'your feelings'
<i>tua-k</i>	+	= <i>ein</i>	+	= <i>ii</i>	→	<i>tua-k</i> = <i>ein</i> = <i>ii</i>	'their-selves'
<i>n-saen=n</i>	+	= <i>kiit</i>	+	= <i>een</i>	→	<i>n-sae=n</i> = <i>kiit</i> = <i>een</i>	'loaded on us'
<i>na-pein</i>	+	= <i>siin</i>	+	= <i>een</i>	→	<i>n-pein</i> = <i>siin</i> = <i>een</i>	'has got them'

As discussed in Chapter 7, the M-form of these enclitics (and a number of other word classes) is the default form. Thus, we can propose that subsequent enclitics attach to the (consonant-final) default form of these enclitics.

Verbs also have a default M-form, but consonant insertion *does* occur after verbs. The difference between verbs and enclitics is probably due to the productivity of the U-form/M-form alternation. For verbs this alternation is completely productive while for enclitics it is less productive and the U-forms are rarely used. Thus for verbs, the U-form is still the underlying morphological form, while for enclitics the M-form may be the underlying morphological form.

A second reason that consonant insertion does not occur after the pronominal enclitics =*kiit* '1PL.ACC' and =*siin* '3PL', is because these have alternate U-forms with a final /a/: =*kita* and =*sina* (§4.2.5). These forms are more conservative than the U-forms =*kiti* and =*sini*, as can be seen by comparing them with their Proto-Malayo-Polynesian etyma **kita* and **sida*. Before the innovation of the U-forms

¹⁵The phrase *estiga* is borrowed from Indonesian S3, an abbreviation of *sarjana tiga* 'third bachelors/scholar'.

5 Phonologically conditioned metathesis and associated processes

=*kiti* and =*sini*, a second enclitic would have attached to /a/ final forms after which consonant insertion does not occur (§5.5). This older pattern has been retained after the innovation of =*kiti* and =*sini*.

The usual pattern after =*ein* 'PL', =*kiit* '1PL.ACC' and =*siin* '3PL' is for no consonant to be inserted after the attachment of a vowel-initial enclitic. However, there are sporadic examples in which /gw/ is inserted after =*ein*. I have so far found three examples, one in my corpus and two in the Amarasī Bible translation, all given in (52) below. In this case the unexpected insertion of /gw/ may be by analogy with insertion of /gw/ after =*n* and =*nu* (§5.6.1).¹⁶

(52) =*ein* + =V → =*eiŋw*V

<i>skora-m</i>	+ = <i>ein</i>	+ = <i>ii</i>	→	<i>skoor-m=eiŋw=ii</i>	‘your schooling’
<i>anah</i>	+ = <i>ein</i>	+ = <i>aa</i>	→	<i>aanh=eiŋw=aa</i>	‘the children’
<i>a-toup noni?</i>	+ = <i>ein</i>	+ = <i>aa</i>	→	<i>a-toup noin?=eiŋw=aa</i>	‘the disciples’

5.8 Historical development

In this section I present some comparative data from other varieties of Meto which indicates that Amarasī consonant insertion before vowel-initial enclitics arose through fortition of an earlier glide. This comparative data also provides the crucial data which leads me to analyse vowel-initial enclitics as containing at least two vowels.

In Amanuban the attachment of a vowel-initial enclitic to a VV# final host triggers insertion of the glide /w/ after back vowels and /j/ after front vowels. Examples are given in (53) below. Data comes from a speaker from Niki Niki (central Amanuban) and Noemuke (south Amanuban).

(53) Amanuban glide insertion

<i>ai</i>	+	=ees	→	<i>aijees</i>	‘one fire’
<i>tei</i>	+	=ees	→	<i>teijees</i>	‘one (pile of) dung’
<i>oe</i>	+	=ees	→	<i>oejees</i>	‘one (body of) water’
<i>fee</i>	+	=ees	→	<i>feejees</i>	‘one wife’
<i>ao</i>	+	=ees	→	<i>aowees</i>	‘one (container of) slaked lime’
<i>too</i>	+	=ees	→	<i>toowees</i>	‘one population’
<i>hau</i>	+	=ees	→	<i>hauwees</i>	‘one tree/piece of wood’
<i>kiu</i>	+	=ees	→	<i>kiuwees</i>	‘one tamarind tree’

¹⁶There is also one example of insertion of /gw/ in my corpus after the alternate plural enclitic =*enu*/=uun: *oemetan* ‘dirty’ + =uun ‘PL’ + *ii* ‘IDET’ → *oemeetn=uunŋ=ii* ‘the dirty one’

Consonant insertion in Amarasī after VV# sequences is probably a development from an Amanuban-like system, with the addition of vowel assimilation and insertion of voiced obstruents rather than glides.

Regarding the voiced obstruents, Amarasī /dʒ/ and /gw/ result from fortition of *j > dʒ and *w > gw. Other Amanuban/Amarasī cognates showing such glide fortition include Amanuban *aijoo*, Amarasī *aidʒoʔo* ‘casuarina tree’ and Amanuban *naijeeʔ* Amarasī *naidʒeer* ‘ginger’.

In Amanuban when a vowel-initial enclitic is attached to a CV# final word the first vowel of the enclitic assimilates to the quality of the final vowel of the host, the host undergoes metathesis, and the final vowel of the host assimilates to the quality of the previous vowel. Examples are given in (54) below. Vowel assimilation does not otherwise affect nouns after metathesis in Amanuban, thus *fafi* + *anaʔ* ‘small, baby’ → *faif anaʔ* ‘piglet’.¹⁷

(54) Amanuban vowel assimilation

<i>fafi</i>	+	=ees	→	<i>faafies</i>	‘one pig’
<i>uki</i>	+	=ees	→	<i>uukies</i>	‘one banana tree’
<i>besi</i>	+	=ees	→	<i>beesies</i>	‘one knife’
<i>mone</i>	+	=ees	→	<i>moonees</i>	‘one husband’
<i>ume</i>	+	=ees	→	<i>uumees</i>	‘one house’
<i>nenō</i>	+	=ees	→	<i>neenoēs</i>	‘one day’
<i>kolo</i>	+	=ees	→	<i>kooloes</i>	‘one bird’
<i>asu</i>	+	=ees	→	<i>aasues</i>	‘one dog’
<i>hanu</i>	+	=ees	→	<i>haanues</i>	‘one mortar’
<i>tefu</i>	+	=ees	→	<i>teefues</i>	‘one sugar-cane stalk’

The first vowel of the enclitic in such examples is often quite short, and in the case of /i/ sometimes reduced to a glide. Thus, *uki* ‘banana’ + =ees ‘one’ → *uukies* → [ʔʊ:kīēs] ~ [ʔʊ:kjēs].

Regarding stems ending in /u/, there seems to be variation between metathesis and vowel assimilation, as illustrated above, and simple attachment of the enclitic with no further changes. An example of the latter in my data is *fatu* + =ees → *fatu=ees* [ʔatʊēs] ~ [ʔatʊwēs] ‘one stone/rock’.

The vowel assimilations which take place in Amanuban when a vowel-initial enclitic is attached to a CV# stem could also represent a precursor to the process of consonant insertion and vowel assimilation in Amarasī.

¹⁷The way the process exemplified in (54) may be connected with the metathesis with final non-syllabic glides attested in some varieties of Amanuban (see §4.5) deserves further investigation.

5 Phonologically conditioned metathesis and associated processes

A system intermediate between that of Amanuban, with assimilation of the first vowel of the enclitic, and that of Kotos Amarasi, with consonant insertion, is attested in Ro'is Amarasi from Buraen.

In Buraen Ro'is Amarasi /b/ is inserted after back vowels and /ɟ/ after front vowels. The first vowel of the enclitic also assimilates as conditioned by the quality of the vowels of the enclitic. If the enclitic is =aa '0DET' the first vowel undergoes complete assimilation, while if the enclitic is =ii '1DET' =ee '3DET/3SG.ACC' or =ees 'one' the first vowel assimilates to the backness, but not the height of the final vowel of the clitic host. Examples are given in (55) below. I do not have sufficient data on the behaviour of other enclitics in Buraen Ro'is after vowel-final hosts to state their behaviour.¹⁸

(55) Buraen Ro'is consonant insertion and vowel assimilation

<i>koro</i>	+	=aa	→	<i>koorboa</i>	'the bird'
<i>nenō</i>	+	=ee	→	<i>neenboe</i>	'the sky'
<i>n-topu</i>	+	=ee	→	<i>n-toopboe</i>	'receives it'
<i>nifu</i>	+	=ees	→	<i>nifboes</i>	'one thousand'
<i>aan fetō</i>	+	=ii	→	<i>aan feetbui</i>	'the daughter'
<i>tenu</i>	+	=ii	→	<i>teenbui</i>	'the third'
<i>brafi</i>	+	=aa	→	<i>braafɟia</i>	'sea cucumber'
<i>tei</i>	+	=aa	→	<i>teedɟia</i>	'the faeces'
<i>meʔe</i>	+	=aa	→	<i>meeʔɟea</i>	'the red ones'
<i>mone</i>	+	=aa	→	<i>moonɟea</i>	'the husband'
<i>fee</i>	+	=aa	→	<i>feedɟea</i>	'the wife'

As in Amanuban, the first vowel of the enclitic is usually extremely short, and in Buraen Ro'is when this vowel is back rounded it can be realised as a glide [w], thus *aan fetō* 'daughter' + =ii → *aan feetbui* [ʔa'n'fɛ:tbɔi] ~ [ʔa'n'fɛ:tbwi].

Assimilation of the first vowel of =aa after front vowels does not seem to be obligatory in Buraen Ro'is. One example from my data is *umi* 'house' + =aa '0DET' → *uumɟ=aa* 'the house' in my data.

Ro'is Amarasi from Tunbaun is similar, though after back rounded vowels the first vowel of the enclitic does not undergo assimilation, and /gw/ is usually inserted. Historically, the /gw/ at clitic boundaries in Tunabun and Kotos Amarasi

¹⁸There are also two examples in my Buraen Ro'is data from a single speaker in which consonant insertion does not take place after the phrase *aan fetō* 'daughter' + =ee → *aan feet=oe* 'the daughter' and + =ees → *aan feet=oes* 'one daughter'. These examples probably represent a more conservative pattern. The same speaker has consonant insertion in other situations, e.g. *noo tenu* + =ii → *noo teenbui* 'the third time'.

may come from re-analysis of [g] and an initial back vowel of the following clitic, though examples such as Kotos *aiɕoʔo* + =*esa* ‘one\ʊ’ → *aiɕooʔgw=esa* ‘one casuarina tree’ rather than **aiɕooʔg=osa* indicate that this glide can no longer be analysed as an underlying vowel.

A system similar to that of Ro’is Amarasi operates in the variety of Meto spoken in Oepaha, though in this case I only have data for the enclitic =*aa* and one example of =*ii*. In Oepaha /b/ is inserted after /o/, /l/ after /e/ and /ɕ/ is inserted after /i/. Examples are given in (56) below. Assimilation of the first vowel of the enclitic does not take place in all examples, though data is too scarce to state any conditions.¹⁹

(56) Oepaha consonant insertion and vowel assimilation

<i>kmii</i>	+ = <i>aa</i> →	<i>hiti kmiiɕia</i>	[hiɽkʰmi:zia]	🔊	‘our urine’
<i>tei</i>	+ = <i>aa</i> →	<i>hiit teeɕia</i>	[hiʰt̪e:ɕia]	🔊	‘our faeces’
<i>uki</i>	+ = <i>aa</i> →	<i>uukɕia</i>	[ʰʊ:kzia]	🔊	‘banana’
<i>oo</i>	+ = <i>aa</i> →	<i>ooboa</i>	[ʰʊ:βwe]	🔊	‘bamboo’
<i>nenō</i>	+ = <i>aa</i> →	<i>neenbaa</i>	[nɛ:nβɛʔn:a]	🔊	‘sky’
		<i>tuun-n=aa</i>	[nɛ:nβɛʔn:a]	🔊	
<i>mone</i>	+ = <i>aa</i> →	<i>hiit moonlea</i>	[hiʰt̪ʰmɔ:nlea]	🔊	‘our husband’
<i>fee</i>	+ = <i>aa</i> →	<i>hiit feelaa</i>	[hiɽfɛ:la]	🔊	‘our wife’
<i>fee</i>	+ = <i>ii</i> →	<i>feelii</i>			‘the wife’

Finally, although slightly orthogonal to the development of consonant insertion in Kotos Amarasi, the processes described for Amanuban CV# stems and vowel-initial enclitics also affect stems with a final glottal stop CVʔ#. The first vowel of the enclitic assimilates to the quality of the final vowel of the host, the host undergoes metathesis, and the final vowel of the host assimilates to the quality of the previous vowel. Examples are given in (57) below.²⁰

¹⁹Oepaha data is limited, coming from a single wordlist and text. Possessed nouns were usually cited with the first person inclusive pronoun *hiit* as a default possessor.

²⁰I do not have data from Amanuban for the behaviour of words with a final consonant other than the glottal stop.

5 Phonologically conditioned metathesis and associated processes

(57) Amanuban vowel assimilation with /ʔ/

<i>asiʔ</i>	+	= <i>ees</i>	→	<i>aasʔ=ies</i>	‘one flea’
<i>masiʔ</i>	+	= <i>ees</i>	→	<i>maasʔ=ies</i>	‘one packet of salt’
<i>suniʔ</i>	+	= <i>ees</i>	→	<i>suunʔ=ies</i>	‘one sword’
<i>kbateʔ</i>	+	= <i>ees</i>	→	<i>kbaatʔ=ees</i>	‘one grub’
<i>tenoʔ</i>	+	= <i>ees</i>	→	<i>teenʔ=oes</i>	‘one egg’
<i>enoʔ</i>	+	= <i>ees</i>	→	<i>eenʔ=oes</i>	‘one door’
<i>esuʔ</i>	+	= <i>ees</i>	→	<i>eesʔ=ues</i>	‘one mortar’
<i>ʔsunuʔ</i>	+	= <i>ees</i>	→	<i>ʔsuunʔ=ues</i>	‘one spoon’

Ro'is Amarasi (both from Buraen and Tunbaun) shows a similar process of vowel assimilation when a vowel initial enclitic attaches to a CVʔ# word. The process in Ro'is is different as the first vowel of the clitic retains its height, with the exception of =*aa* in which complete assimilation takes place. Examples are shown in (58) below.²¹

(58) Ro'is Amarasi vowel assimilation with /ʔ/

<i>n-senuʔ</i>	+	= <i>ee</i>	→	<i>n-seenʔoe</i>	‘replaces it’
<i>na-kninuʔ</i>	+	= <i>ee</i>	→	<i>na-kniinʔoe</i>	‘cleans it’
<i>na-seroʔ</i>	+	= <i>ee</i>	→	<i>na-seerʔoe</i>	‘mixes it’
<i>unuʔ</i>	+	= <i>ii</i>	→	<i>uunʔui</i>	‘long ago’
<i>mnanuʔ</i>	+	= <i>ii</i>	→	<i>mnaanʔui</i>	‘the length’
<i>metoʔ</i>	+	= <i>ii</i>	→	<i>meetʔui</i>	‘the dry land’
<i>mororoʔ</i>	+	= <i>ii</i>	→	<i>moorʔui</i>	‘the yellow one’
<i>bɔʔakaseʔ</i>	+	= <i>ees</i>	→	<i>bɔʔakaasʔees</i>	‘one horse’
<i>na-sukiʔ</i>	+	= <i>ee</i>	→	<i>na-suukʔee</i>	‘supports it’
<i>atoniʔ</i>	+	= <i>ii</i>	→	<i>atoonʔii</i>	‘the man’
<i>atoniʔ</i>	+	= <i>aa</i>	→	<i>atoonʔia</i>	‘the man’

The data in which the first vowel of the enclitic undergoes assimilation to the final vowel of the host provides the crucial evidence which has swayed me to analyse all vowel-initial enclitics as containing two vowels, rather than a single vowel as I proposed in my PhD thesis (Edwards 2016b). Under an analysis in which these enclitics contain a double vowel, this process can be explained as a case of the first vowel of the enclitic undergoing assimilation. However, if such enclitics contained only a single vowel, it is difficult to explain the presence of the additional vowel in these examples.

²¹The Ro'is data for stems whose final vowel is a front vowel is somewhat ambiguous as I only have one example in which the first vowel of the enclitic has clearly assimilated: *atoniʔ* + =*aa* → *atoonʔ=ia* ‘the man’.

5.9 Conclusion

Metathesis before vowel-initial enclitics can be analysed as phonologically conditioned. When a vowel-initial enclitic is added to a stem this triggers a number of phonological processes: metathesis, consonant insertion, and vowel assimilation.

The first process is consonant insertion (§5.3). Consonant insertion occurs because feet require an onset. The next process is metathesis (§5.2). Metathesis occurs before enclitics to create a crisp edge after an internal prosodic word. Analysing metathesis as motivated by CRISP EDGE is crucially dependent on the analysis of intervocalic consonants as ambisyllabic (§3.3.1). The final process is vowel assimilation (§5.4), under which any vowel which conditioned insertion of a consonant assimilates. This occurs because after metathesis any such vowel shares features with the inserted consonant across another C-slot.

In one environment Amarasi metathesis is phonologically conditioned. It occurs to create a phonological boundary between two prosodic words. However, as discussed in Chapter 2, just because *some* instances of metathesis in a language are phonologically conditioned, does not mean *all* instances of metathesis in that language are phonologically conditioned. In addition to phonologically conditioned metathesis, Amarasi also has instances of metathesis which cannot be accounted for by reference to phonology alone. Amarasi has two kinds of morphological metathesis: metathesis marking syntactic structures (Chapter 6) and metathesis marking discourse structures (Chapter 7).

6 Syntactically driven metathesis

6.1 Introduction

In this chapter I describe and analyse the function of Amarasi metathesis in the syntax. In the syntax, metathesis is a morphological device marking the presence of an attributive modifier.¹ A metathesised word is a construct form (§2.6.1) signalling the presence of a dependent modifier. A syntactic M-form (metathesised form) canonically occurs in a complementary relationship with a U-form (unmetathesised form), the latter of which syntactically completes the former.

An example of the syntactic function of metathesis can be seen by comparing examples (1) and (2) below. Each consists of the noun *nenō* ‘day’ followed by the numeral *mese?* ‘one’. When the head nominal occurs in the U-form, the numeral is the head of a number phrase and has a cardinal meaning. However, when the head nominal occurs in the M-form, the numeral occurs within the noun phrase and has an ordinal meaning.

- | | | | | | |
|-----|-------------------|---------------------|-----|------------------------------|--------|
| (1) | ,nenō | 'mese? | (2) | ,ne.ən | 'mese? |
| | [NP <i>nenō</i>] | [Num <i>mese?</i>] | | [NP <i>neon mese?</i>] | |
| | day\U | one\U | | day\M one\U | |
| | 'one day' 🗣️ | | | 'first day (i.e. Monday)' 🗣️ | |

Each of the phrases in (1) and (2) has identical intonation and stress, as can be heard with the accompanying audio files. Neither do the vowels of the M-form collapse into a single phonetic syllable. The *only* phonetic difference between each of these phrases is the order of the final consonant and vowel of the head nominal; metathesis. (See §6.3.5 for more discussion of this, and similar examples.) Trees showing the structure of each of (1) and (2) are given in (3) and (4) respectively.

¹There is no competition between metathesis in the syntax and phonologically conditioned metathesis (Chapter 5). Syntactically triggered metathesis affects word-medial members of a phrase while vowel-initial enclitics attach to the final members of phrases. Similarly, there is no competition between metathesis marking syntactic structures and metathesis marking discourse structures. This is discussed in full detail in §7.2.

6 Syntactically driven metathesis

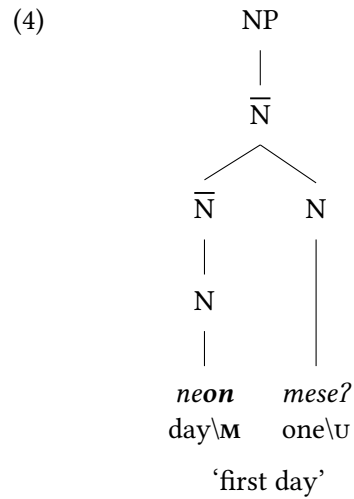
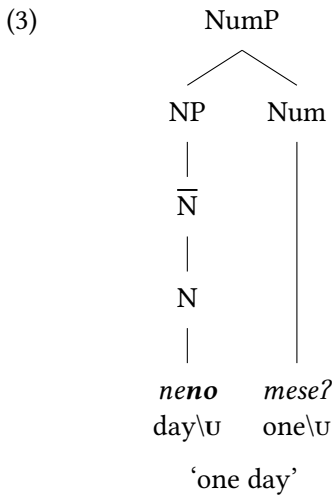

Another example of metathesis in the syntax can be seen by comparing examples (5) and (6) below. Example (5) with an initial U-form is an equative clause (§6.6) with two nominals as subject and predicate, while example (6) with an initial M-form consists of a single nominal phrase with the second nominal functioning attributively as a dependent modifier. Each of these phrases also has identical stress and intonation, with the different syntax signalled only by metathesis.

(5) [_{NP} *fatu*] [_{NP} *koʔu*]
 stone\U big\U
 ‘Stones are big.’

(6) [_{NP} *faut koʔu*]
 stone\M big\U
 ‘(a) big stone’

Similarly, within the verb phrase metathesis marks the presence of a modifying verb and thus marks a serial verb construction. Compare examples (7) and (8) below. Example (7) contains two adjacent verbs with the first in the M-form. Thus, both verbs belong to a single verb phrase and are a serial verb construction describing a single event. Example (8), on the other hand, has two adjacent verbs with the first in the U-form, and each verb is the head of its own verb phrase and describes two separate events. Syntactic trees of each of these examples are given in (9) and (10) below respectively.

(7) *saap au* [_{VP} *ʔ-soiʔ u-rair.*]
saap au ʔ-soʔi u-rari
 because 1SG 1SG-count\M 1SG-finish\M
 ‘Because I’d finished counting.’

130825-6, 0.36 🔊

- (8) *Maksen* [_{VP} *n-ami*] [_{VP} *n-aim*] *n-ak suuk na-hine =t*,
 Maksen n-ami n-aim n-ak suuk na-hine =te
 Maksen 3-search\U 3-search\M 3-say rather 3-know\U =SUB
 ‘Maksen searched and searched, he said that when he knew ...’ 130925-1,
 3.32 🔊

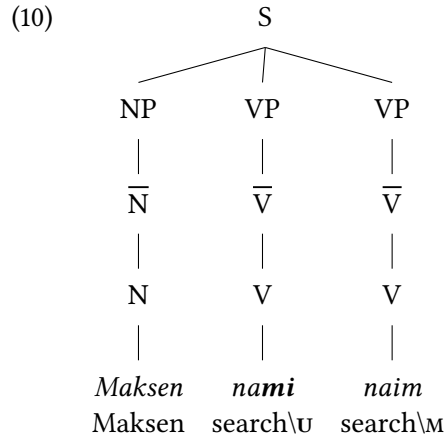
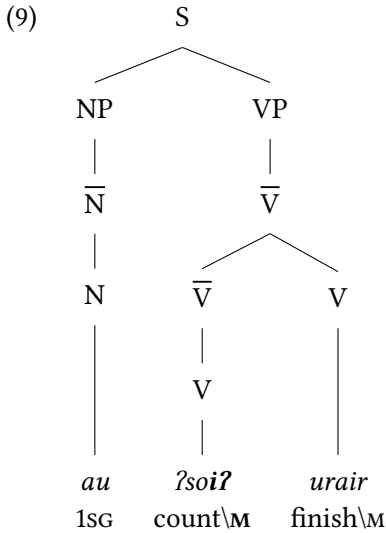

Under the syntactic analysis I propose, metathesis is restricted to the domain of \bar{X} (X-bar); \bar{N} within the nominal phrase and \bar{V} within a phonotactically restricted subset of verb phrases. Whenever a word of the same word class as the head occurs within \bar{X} , the head occurs in the M-form. Each non final word in \bar{X} is in the M-form with the final word of \bar{X} in the U-form. The maximal structure of the extended nominal in Amarasi is given in (11) and the structure of the verb phrase in (12) with the domain of metathesis indicated.

Attributive modification is a phenomenon which typically occurs in syntax but it can also occur in morphology. In this chapter I analyse attribution within the syntax. (The possibility of analysing attribution within the morphology is discussed in §6.8.) In Amarasi, the marking of modification is a functional requirement which impacts on the surface realisation. An M-form is the morphological marking of a syntactic relationship between two nominals or two verbs.

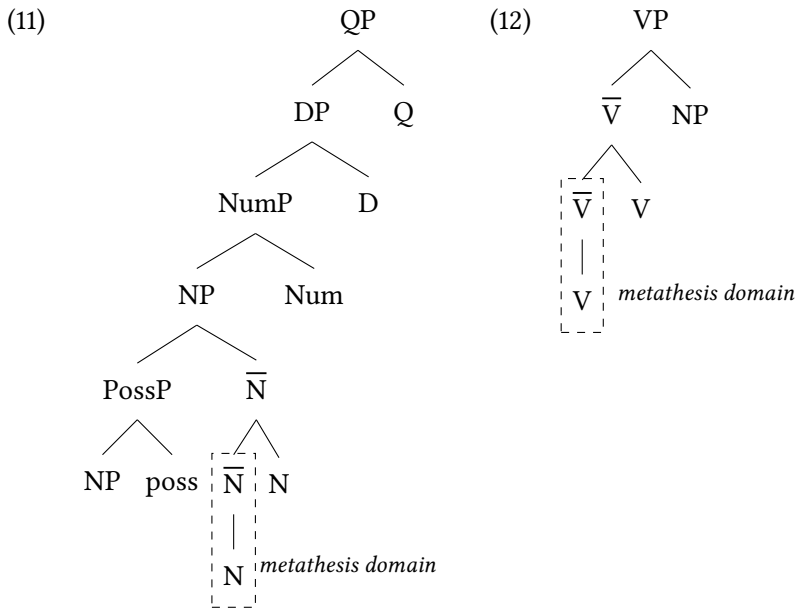

Most of this chapter is devoted to a discussion of the extended nominal phrase in which M-forms are more obviously and thoroughly constrained by syntax. I begin in §6.2 by discussing the syntactic and morphological criteria which define a word class of nominals in Amarasi. There is no morpho-syntactic basis for distinguishing between a class of adjectives and nouns in Amarasi.

In §6.3 I discuss the structure of attributive phrases which trigger metathesis on the head nominal. In §6.4 I show that possession does not trigger metathesis on the head nominal. In §6.5 I show that modifiers which are not nominals do not induce metathesis on the head nominal. Such modifiers include numerals, demonstratives, and quantifiers. In §6.6 I discuss the structure of equative clauses which involve two nominal phrases but do not trigger M-forms. In §6.7 I discuss the structure of the verb phrase and serial verb constructions in which non-final verbs usually occur in the M-form. I conclude in §6.8 by discussing an analysis of metathesis in the syntax as being conditioned by prosodic structures.

6.2 The nominal word class

Content words (non-functors) in Amarasi fall into two major word classes: nominals and verbs. Some roots are specified as nominal roots, some roots are specified as verbal roots and some roots are precatatorial (Donohue 2008), being spec-

ified as neither nominal nor verbal. Table 6.1 lists the most salient morphosyntactic criteria which allow us to distinguish between nominals and verbs in Amarasī.

Table 6.1: Amarasī word classes[†]

	agr-	NML	TR	RECP	C#→∅	SUBJ/OBJ	=Det	=Num
Nominal	–	–	–	–	✓	✓	✓	✓
Precategorial	✓	✓	✓	✓	✓	✓	✓	✓
Verb	✓	✓	✓	✓	–	–	–	–

[†] agr-: take verbal agreement prefixes (§A.1.1), NML can be nominalised with the circumfix *a-...-t* (§A.2.1), TR can take the transitive suffix *-b* (§A.3.2), RECP can take the reciprocal prefix *ma(k)-* (§A.1.2), C#→∅ final consonant can be deleted to derive verbs (§6.2.1), SUBJ/OBJ can be the subject or object of a verb, =Det can take definiteness marking determiners (§6.2.3), =Num can take number enclitics (§6.5.1.1).

In this section I discuss the four criteria in Table 6.1 which allow us to identify a nominal word class: verbal derivation (§6.2.1), verbal arguments (§6.2.2), determiner modification (§6.2.3) and number enclitic modification (§6.2.4).

There is no morphosyntactic basis for distinguishing separate classes of nouns and adjectives. All differences in the behaviour of these putative categories are straightforwardly explained by their semantics. For instance, only adjective-like nominals have been attested modified by *besi* ‘very’. This can be explained by the fact that some nominals, such as *re?uf* ‘bad’, are gradable, while other nominals, such as *fatu* ‘stone’, are not gradable in Amarasī.

When it is necessary to distinguish between these semantic categories, I call nominals which refer to things *thing nominals* and nominals which describe such things *property nominals*. Many nominals do not belong clearly to either of these semantic categories. Three such examples are: *mnanu?* ‘long/length, deep/depth’ *kase* ‘foreign(er)’ and *ana?* ‘small, baby’.

6.2.1 Base for verbal derivation

Amarasī has a morphological process of subtraction which derives a verb from a nominal. Under this process the final consonant of a nominal root is deleted. Verbs derived by this process are usually intransitive. Examples of verbs derived from nominals by word-final consonant deletion are given in (13) below. Verbs are listed with the 3SG prefix *na-/n-*.

In many cases the deleted consonant is historically analysable as a suffix. Thus, for instance, Amarasī *mnasi?* ‘aged, old’ is cognate with Termanu ‘old’ *lasi-k* and

6 Syntactically driven metathesis

Dengka ‘old’ *lasi-ʔ* with a final suffix *-k/-ʔ* which is a productive suffix in the languages of Rote. However, such final consonants are no longer analysable as suffixes in Amarasi.

Furthermore, such nominal/verb pairs include several in which the final consonant of the noun is an inheritance from Proto-Malayo-Polynesian. Examples include are **quzan* > *uran* ‘rain’ → *na-ʔura* ‘rains’, **ma-diŋdiŋ* > *mainikin* ‘cold’ → *n-mainiki* ‘is cold’, and **tapis* > *tais* ‘sarong’ → *na-tai* ‘clothes s.o.’.

(13) ..VC# nominal → ..V# verb

‘rain’	<i>uran</i>	→	<i>na-ʔura</i>	‘rains’
‘cold’	<i>mainikin</i>	→	<i>n-mainiki</i>	‘is cold’
‘sea snail’	<i>kbatus</i>	→	<i>na-kbatu</i>	‘gathers sea snails’
‘digging stick’	<i>ʔsuak</i>	→	<i>na-ʔsua</i>	‘digs with a digging stick’
‘umbrella’	<i>tenuk</i>	→	<i>n-tenu</i>	‘shades’
‘sarong’	<i>tais</i>	→	<i>na-tai</i>	‘(s/he) clothes s.o.’
‘dry’	<i>metoʔ</i>	→	<i>n-meto</i>	‘is dry’
‘aged, old’	<i>mnasiʔ</i>	→	<i>na-mnasi</i>	‘becomes old’
‘bad’	<i>reʔuf</i>	→	<i>n-reʔu</i>	‘is broken/bad’

6.2.2 Subject and object

Nominal phrases are eligible to be the subject or object of a verb. Amarasi word order is subject verb object (SVO). Any extended nominal phrase can be a subject or object in Amarasi while there are no examples of verbs as objects or subjects in my entire corpus. Two examples of a nominal as the subject of a clause are given in (14) below.

- (14) [SUBJ *beʔi*] *na-suna =te*, [SUBJ *naʔi*] *n-sapi ʔso- ʔpanu ʔsonoʔ*.
 PM 3-spin =SUB PF 3-shave shell_M spoon
 ‘While the grandmothers were spinning thread, the grandfathers
 would cut coconut shells into spoons.’ 120715-3, 0.33 🔊

Two examples of a nominal phrase with a single nominal in post-verbal position as the object of the clause are given in (15) and (16) below.

- (15) *n-naaʔ* [OBJ *benas*] *he n-nao =t, aʔi-*
 3-hold machete IRR 3-go =SUB yesterday
 ‘He was holding a machete to go, yesterday..’ 130914-2, 0.46 🔊

- (16) *nenō nima =te, hai m-piir* [OBJ **bupati**]
 day five =SUB 1PX 1PX/2-elect regent
 ‘After five days we’ll elect a regent.’ 130902-1, 4.32 🔊

When the object nominal has already been introduced in the discourse and/or is a known participant, it is preceded by *re?*. Such uses of *re?* are glossed TOP ‘topic’.² Two examples of topical objects preceded by *re?* are given in (17) and (18) below, each of which is extracted from a history of the village of *Koro’oto*. In example (17) the topical participant is introduced as a subject in (17a). It is repeated as subject in (17b) and when it is an object in (17c) it is preceded by *re?*.

- (17) How the hamlet of Koro’oto got its name: 160326 🔊
- a. *neot=esa =te, siin n-took na-mfa~faun =ate koorgw=ees, a|n-kae.*
 time=one =SUB 3PL 3-sit 3-INTNS-many =SUB bird=one 3-cry
 ‘One time while they were all sitting together a bird cried.’ 4.16
- b. *ko-ro ia n-kae =t n-ak: “koor’oot, koor’oot, koor’oot.”*
 bird 1DEM 3-cry =SUB 3-say koor’oot koor’oot koor’oot
 ‘This bird cried out: “koor’oot, koor’oot, koor’oot”.’ 4.25
- c. *siin hai be?i na?i =siin n-aim* [OBJ **re? ko-ro ia.**]
 3PL 1PX PM PF =ASSOC.PL 3-look.for TOP bird this
 ‘Those ancestors of ours looked for this bird.’ 4.31

In example (18) the object of the locational verb *n-bi* is *Koor’oot* ‘Koro’oto’ which has long since been established as a highly topical participant in this story.

- (18) *na, ʔadi noki-noki =te, na-tua n-bi* [OBJ **re? Koor’oot**] *sero ?roo.*
 well so eventually =SUB 3-live 3-RL.LOC TOP Koro’oto rather long
 ‘Eventually they’d been living in Koro’oto a while.’ 160326, 10.06 🔊

Nominal phrases containing only a property nominal can also be verbal arguments. Two examples of such nominal phrases as the object of a verb are given in (19) and (20) below.³

- (19) *a|n-mo?e =ma n-pooʔ=ena n-bi* [OBJ **meto?.**]
 3-make =and 3-exit=INCEP 3-RL.LOC dry
 ‘He made and went out onto a dry place.’ 120715-4, 0.45 🔊

²The other function of *re?* is as a general purpose relativiser, (glossed REL). In Koro’oto village *re?* has the optional alternate form *ne?* and in Ro’is Amarasi it has the form *he?*.

³There is no morphosyntactic basis for separating the locational verbs *n-bi* RL.LOC (realis locative) and *n-eu* DAT (dative) from the word class of verbs.

6 Syntactically driven metathesis

- (20) *baisenu-t =ma ronaen n-eu* [_{OBJ} *muti?* =*ma mnatu?*] *et*
 look.up-NML =and greeting 3-DAT white and gold IPFV.LOC
muit ma-hine-? =*ma mnatu? nee.*
 white\M PROP-know-PROP =and gold PAUSE
 ‘Greetings and honour to (those like) silver and gold, wise silver and gold’
 (figurative for ‘wise and honoured dignitaries’.) 140726, 0.00 🔊

Other parts of the extended nominal phrase including numbers, demonstratives, and quantifiers can also be the subject and object of a verb. Examples are given in §6.5.

6.2.2.1 Pronominal subjects and objects

Pronouns are a subclass of nominals in Amarasi. They can be distinguished from other nominals as they inflect for case: nominative or accusative. Nominative pronouns are given in Table 6.2a and accusative pronouns in Table 6.2b. Nominative pronouns are used for subjects, and accusative pronouns for objects and/or benefactives.⁴ (The Ro’is 3SG nominative pronoun is *hiin*.)

Table 6.2: Amarasi pronouns

(a) Nominative pronouns

	SG	PL
1	<i>au</i>	<i>hai</i>
1,2		<i>hiit</i>
2	<i>hoo</i>	<i>hii</i>
3	<i>iin</i>	<i>siin</i>

(b) Accusative pronouns

	SG	PL
1	= <i>kau</i>	= <i>kai</i>
1,2		= <i>kiit</i>
2	= <i>koo</i>	= <i>kii</i>
3	= <i>ee</i>	= <i>siin</i>

Two examples of nominative pronouns as the subject are given in (21) and (22) below, with the verbal agreement also indicated. Two examples of an accusative pronoun as the object of a verb are given in (23) and (24) below.

- (21) *au he u-toon n-ok kuan Nekomese?*
 1SG IRR 1SG-tell 3-with village Nekomese’
 ‘I want to talk about Nekomese’ village.’ 120715-1, 0.30 🔊

⁴Accusative pronouns are also used as the second element in a pronominal equative clause (§6.6).

- (22) *hoo mu-mnau fatu Brao=n kona? hiut?*
 2SG 2SG-remember stone Brao=PL hole seven
 ‘Do you remember the Brao stones’ seven holes?’ 120715-4, 3.05 🔊
- (23) *mama na-tuina? =kau =ma,*
 mum 3-follow =1SG.ACC =and
 ‘Mum agreed with me and...’ 130907-4, 2.32 🔊
- (24) *erteekɟ=ii n-poo? =kai =ma hai m-fena =m*
 neighbourhood.head=1DET 3-wake =1PX.ACC =and 1PX 1PX/2-rise =and
 ‘The neighbourhood head woke us up and we got up’ 130902-1, 3.38 🔊

The third person singular accusative pronoun is the vowel-initial enclitic =*ee*. Examples are given in (25) and (26) below. This enclitic is also a nominal determiner, marking the definiteness and topicality of a nominal phrase (see §6.2.3.1 for more details).

- (25) *na-sae-b=ee =m n-eekɟ=ee n-nao n-bi Alor.*
 3-rise-TR=3SG.ACC =and 3-take=3SG.ACC 3-go 3-RL.LOC Alor
 ‘(They) picked him up and took him to Alor.’ 130907-3, 10.29 🔊
- (26) *oras ia au ?-oop?=ee n-fain et au kuan.*
 time 1DEM 1SG 1SG-pour=3SG.ACC 3-again IPFV.LOC 1SG village
 ‘Now I’m just pouring it back into my (own) village.’ 130825-6, 3.33 🔊

One syntactic test which allows us to identify a word class of nominals in Amarasi is that nominals can be the subject or object of a verb.

6.2.3 Determiners

Another syntactic criterion which nominals fulfil is that they can be followed by a determiner. The Amarasi determiners are given in Table 6.3 below. They have the same four person values present in the genitive suffixes (§A.3.1, §6.4.2).



All these determiners are vowel-initial enclitics, and the stem to which they attach undergoes phonologically conditioned metathesis, as discussed in Chapter 5. (Such phonologically conditioned M-forms are glossed ‘ \bar{m} ’.) These enclitics occur after definite topical nominals, discussed further in §6.2.3.1 below.

The enclitic =*ee* can also attach to a verb to mark a third person singular pronominal object. Similarly, the enclitic =*ii* can attach to a phrase to raise the discourse prominence of that phrase. The enclitics =*aan* ‘2DET’ and =*aa* ‘0DET’



Table 6.3: Amarasi determiners

Form	Gloss	Use
= <i>ii</i>	1DET	definite referent near/relevant to speaker
= <i>ana</i> /= <i>aan</i>	2DET	definite referent near/relevant to addressee
= <i>ee</i>	3DET	definite referent near/relevant to a third person
= <i>aa</i>	0DET	definite referent near/relevant to no one (\approx obviative)

have only been attested attached to a nominal phrase. An example of each is given in (27) and (28) below.

- (27) *Meok Seran aanh=aan nai? sekaagw=een?*
 Meok Seran child=2DET Mr. who=INCEP
 ‘Who is Meok Seran’s son, then?’ 130825-6, 6.31 
- (28) *atoni? iin, n-pairoir iin mui?t=aa =t iin n-hae q̄adi*
 man 3SG 3-prepare 3SG animal=0DET =SUB 3SG 3-tired so
 ‘Someone prepares his animal (then) he’s tired, so ...’ 120923-1, 7.15 

Property nominals can also take any of the nominal determiners given in Table 6.3. Examples are given in (29) and (30) below.

- (29) *hoo m-aitq̄=ee berarti of hoo m-ait mu-fani?*
 2SG 1PX/2-take=3SG.ACC mean later 2SG 1PX/2-take 2SG-repeat
mapuut?=ee.
 hot=3DET
 ‘(If) you take it, it means that later you’ll burn repeatedly.’ (*lit.* ‘take repeatedly the hot/heat’) 120923-1, 12.22 
- (30) *n-poi n-bi meot?=ee onai =te*
 3-exit 3-RL.LOC dry=3DET like.that =SUB
 ‘Having gone out onto the land like that ...’ 120715-4, 0.47 

6.2.3.1 Function of determiners

Determiners in Amarasi occur attached to definite referents which could be expected from the discourse context. They cannot occur on referents with the pragmatic role of focus (in the sense of Lambrecht 1994: 214). They have four person

values, and naturally pattern with equivalent pronouns, as illustrated in examples (31)–(34) below.

- | | |
|--|--|
| <p>(31) au niis-k=ii
 au nisi-k=ii
 1SG tooth-3PL/1GEN=1DET
 ‘my tooth’</p> | <p>(32) hoo niis-m=aan
 hoo nisi-m=ana
 2SG tooth-1PX/2GEN=2DET
 ‘your tooth’</p> |
| <p>(33) iin niis-n=ee
 ini nisi-n=ee
 3SG tooth-3SG.GEN=3DET
 ‘her/his tooth’</p> | <p>(34) iin niis-n=aa
 ini nisi-n=aa
 3SG tooth-3SG.GEN=0DET
 ‘someone’s tooth’</p> |

The use of these determiners to mark expected definite nominals is illustrated in (35) below. The discourse of (35) is structured such that each clause (except the first) is paralleled by the following clause. The first part of each pair (35b, 35d, 35f) introduces a new participant, with this participant then repeated marked with a determiner in the second part of each pair (35c, 35e, 35g).

- (35) How Moo'-hitu made the world: 120715-4 🔊
- a. *na? n-sanu n-fani kre?o~kre?o =ma*
 then 3-descend 3-back FRD~slow =and
 ‘Then (he) went back down slowly and’
- b. *n-fani n-bi iin [bara-n.]_{NEW-i}*
 3-return 3-RL.LOC 3SG place-3SG.GEN
 ‘went back to his place.’ 0.37
- c. *n-fani n-bi iin [baar-n=ii.]_{OLD-i}*
 return 3-RL.LOC 3SG place-3SG.GEN=1DET
 ‘went back to his place.’
- d. *iin [baar-n=ee]_{OLD-i} et oodɔ=ee [nana-n.]_{NEW-j}*
 3SG place-3SG.GEN=3DET IPFV.LOC water=3DET inside-3SG.GEN
 ‘His place was in the water.’ 0.40
- e. *n-bi~bi oodɔ=ee [naan-n=ee]_{OLD-j} onai =te,*
 3-FRD~RL.LOC water=3DET inside-3SG.GEN=3DET and.then
 ‘Having been in the water for a while,’ 0.43

6 Syntactically driven metathesis

- f. *a|n-mo?e =ma n-poodz=ena n-bi* [*meto?*]_{NEW-k}
 3-make =and 3-exit=INCEP 3-RL.LOC dry
 ‘(he) made and went out onto dry land.’ 0.45
- g. *n-poi n-bi* [*meot?=ee*]_{OLD-k} *onai =te,*
 3-exit 3-RL.LOC dry=3DET and.then
 ‘Having gone out onto the dry land,’
- h. *iin ka= n-mui?=fa* [*bare*]_{NEW-l} *he na-tua =m*
 3SG NEG= 3-have =NEG place IRR 3-settle =and
 ‘he didn’t have a place to live and, ...’ 0.47

The choice between different determiners is extremely subtle and serves to signal different levels of discourse prominence among definite participants. In (35) above each second mention of *nana-n* ‘inside’ in (35e) and *meto?* ‘dry’ in (35g) occur with the third person determiner =*ee*. Each of these nouns is also only mentioned twice in this extract. This is in contrast to *bara-n* ‘place’, which on its second mention in (35) occurs with the first person determiner =*ii*. This noun is also the only noun which occurs three times in this extract with its third mention in (35d) occurring with the third person determiner =*ee*.⁵

The first person determiner raises the discourse prominence of the participant it is attached to and signals that this participant is slightly more important than other participants. Such subtleties are further illustrated in (36) below, in which a single participant occurs with =*ii* ‘1DET’ on its first mention and =*aan* ‘2DET’ on its second mention.

- (36) Asking for the name of someone: 130825-6 
- a. *hoo feat-f=ii* *bi sekau?*
 2SG man’s.sister-GEN=1DET Ms. who
 ‘Who is your sister?’ 2.06
- b. *au aanh=ii nai? Lukas feecz=aan?*
 1SG child=1DET Mr. Lukas wife=2DET
 ‘My son Lukas’s wife?’ 2.09

By changing from the first person determiner in (36a) to the second person determiner =*aan* in (36b) the speaker moves this participant from his own “space” to the “space” of the addressee; it is knowledge the speaker wants to know but which the addressee is presumed to have access to.

⁵The same noun occurs in (35h), though with a different referent. The final vowel of *bare* ‘place’ is irregularly /a/ when a genitive suffix is attached; *bara-n* place-3SG.GEN.

6.2.4 Number enclitics

Another characteristic of Amarasi nominals is that they can be modified by either of the number enclitics given in Table 6.4 below. The syntactic structure of these number enclitics is discussed in §6.5.1.1. Examples of a nominal followed by a number enclitic are given in (37)–(39) below. Broadly speaking, allomorph *=ein* of the plural enclitic is used after consonant-final stems and *=n* after vowel-final stems (see §5.6 for a full discussion).

Table 6.4: Amarasi number enclitics

Form	Gloss	Use
<i>=ein, =n</i>	PL	plural
<i>=esa/=ees</i>	one	indefinite singular; the numeral one (1)

- (37) *sbaek?=ees na-fua, sbaek?=esa msa? na-fua.*
 branch=one 3-fruit branch=one also 3-fruit
 ‘A branch grew fruit, another branch also grew fruit.’ 130822-1, 0.56 🔊
- (38) *a/n-tui hii kaan-m=ein n-bi ean?=ein ehh?*
 3-write 2PL name-1PX/2GEN=PL 3-RL.LOC door=PL Q
 ‘Were your names were written on the doors?’ 130825-7, 0.38 🔊
- (39) *karu hoo m-serak =kau au huut=n=aan.*
 if 2SG 1PX/2-take.apart =1SG.ACC 1SG head.louse=PL=2DET.
 ‘if you part (my hair), (those) are my lice’ 130914-3, 0.58 🔊

Examples of property nominals which are the head of a nominal phrase modified by a number enclitic are rare. This is probably due to the fact that property nominals do not usually have a countable meaning. Three examples from the Amarasi Bible translation are given in (40)–(42) below. In examples (40) and (41) the nominal modified by *=ein* is a property nominal derived from a verbal root with the property circumfix *ma-...-?* (§A.2.2).

- (40) *ma are? kana=n rasi re? ka= ma-hini-? =fa oras ia,*
 And every name=PL matter REL NEG= PROP-know-PROP =NEG time 1DEM
of ma-hiin-?=ein.
 later PROP-know-PROP=PL
 ‘And each matter which is not known now will later be known.’ Luke 8:17

6 Syntactically driven metathesis

- (41) *na-tuin baerʔ=ein naan siin ka= ma-ʔoos-ʔ=ein =fa.*
 3-because thing=PL 2DEM 3PL NEG= PROP-price-PROP=PL =NEG
 ‘Because those things have no value.’ Genesis 33:11
- (42) *rari =t niti mnaut nuaʔ=ein naan siin maʔfeen-k=ein*
 finish =SUB bracelet gold two=PL 2DEM 3PL heavy-3PL/1GEN=PL
sekel boʔ=ees.
 shekel ten=one
 ‘Then those two gold bracelets weighed ten shekels.’ (*lit.* ‘their heavinesses were ten shekels’) Genesis 24:22

The plural enclitic *=ein/=n* also occurs with verbs. When it does so it marks that one of the arguments is plural.

6.2.4.1 The polyfunctional form *ees*

The form *esa/ees* has a number of functions in Amarasi, not all of which are as an enclitic. These are derived from or extensions of Proto-Malayo-Polynesian *əsa ‘one’. It has the U-forms (=)*esa* and the M-form (=)*ees*. However, the use of each form is not fully productive, as is consistent with other functors which have U-forms and M-forms. While at an abstract level the M-form must be posited as having two underlying vowels *ees* it is usually unstressed and pronounced with a single vowel.

The most frequent use of this form is as a number enclitic attached to a noun phrase. When it does so, it has a range of uses which range between the numeral ‘one (1)’ and a more semantically bleached indefinite marker. Two examples in which the numeral meaning of this enclitic is not prominent are given in (43) and (44) below.

- (43) *fe_mnaisʔ=ees nema =ma n-ak:*
 old.woman=**one** 3\come =and 3-say
 ‘An old woman came and said:...’ 120715-3, 0.46 🔊
- (44) a. *naiʔ Soan reʔ ia iin am-neem-n=ii na-ʔko,*
 Mr. Soan REL 1DEM 3SG NML-come-3SG.GEN=1DET 3-ABL
- b. *paah kuan=ees kaan-n=ee Kuatunis.*
 country village=**one** name-3SG.GEN=3DET Kuatunis
 ‘This Soan came from a village called Kuatunis.’ 130821-1, 3.47 🔊

Two examples in which the numeral function of *=ees* is more prominent are given in (45) and (46) below.

- (45) *oka =t tuaf nua n-fain nai =t, tuaf=ees na-maika?*
 after.that person two 3-return already =SUB person=**one** 3-stay
n-ok =kiit funan nua, of hii ees m-oka=n.
 3-with =1PL.ACC moon two later 2PL one 1PX/2-with=PL
 ‘After that when two people have already gone back one person will stay
 with us for two months, later you’ll be the ones with him.’ 130821-1, 1.17
 🔊

- (46) *taaʔɔʔ=ees=ii mutiʔ.*
 branch=**one**=1DET white
 ‘One of these branches was white.’ 130823-2, 0.49 🔊

The form *esa/ees* also has a number of non-enclitic uses as an independent word. Unlike the enclitic uses, *esa/ees* as an independent word begins with an automatic glottal stop as [ʔesə] or [ʔes] as is expected for vowel-initial words (§3.3.6). None of these uses trigger M-forms. One of these uses is as the head of number phrase with the meaning ‘one’, as in examples (47) and (48) below. In such uses it selects a single referent out of a range of possible referents.

- (47) a. *ees eta ʔTakaʔ, ʔTakaʔ.*
 one IPFV.LOC 'Taka' 'Taka'
 ‘One (of them) was at 'Taka', (that one is) 'Taka'.’ 120715-1, 0.44 🔊
- b. *ees et Kotos, Koorʔoto.*
 one IPFV.LOC Kotos Koro'oto
 ‘One (of them) was at Kotos, (that one is) Koro'oto.’ 0.47
- (48) *esa n-poi n-teniʔ.*
 one 3-exit 3-again
 ‘One (of them) came out again.’ 130906-1, 3.15 🔊

Probably as an extension of this use, *esa/ees* is used in a contrastive focus construction in which it introduces participants who are in contrast with other participants of the discourse. Often this contrast is implicit, and indeed in many instances the contrast function is semantically bleached and *esa/ees* functions as a copula or relativiser. Such uses of *ees* are glossed as COP. Four examples are given in (49)–(50) below.

- (49) *ɔʔadi, iin naʔi iin beʔi ees n- na-konaʔ reʔ fatu Brao=n.*
 so 3SG PF 3SG PM COP 3-hole TOP stone Br.=PL
 ‘So, his ancestors were the ones who made the holes in the Brao stones.’
 120715-4, 4.07 🔊

6 Syntactically driven metathesis

- (50) *au ees a-meup umi.*
 1SG COP NML-work house
 ‘I’m the one building the house.’ (*lit.* ‘house worker’) Obs. 13/09/14, p.96
- (51) *au ees a-na~nao-t. au ees a-tok~took sidan.*
 1SG COP NML-INTNS~go-NML 1SG COP NML-INTNS~sit meeting
 ‘I was the one who went (*lit.* goer). I was the one who attended the meetings
 (*lit.* meeting sitter).’ 130907-3, 8.40 🔊
- When *esa/ees* is used as a copula, it has the optional plural form *esa=n*, when the subject is plural. Two examples of plural *esa=n* are given in (52) and (53).
- (52) *iin na?i iin be?i esa=n re? ma-keen uun.*
 3SG PF 3SG PM COP=PL REL PROP-weapon earlier
 ‘His ancestors were the ones who were at war.’ 120715-4, 3.57 🔊
- (53) *na, uab=ein esa=n re? ia.*
 well speech=PL COP=PL REL IDEM
 ‘Well, these are the things I wanted to say.’
 (*lit.* ‘Speeches are the ones who are here.’) 130905-1, 1.18 🔊

Finally, there is a homophonous word [ʔes], transcribed *es*, which is a locative marker. This *es* is probably not cognate with the numeral *esa/ees*, and is instead related to locative *et*. These forms appear to have no semantic difference. Both are an imperfective locative. Following the definition of Comrie (1976: 16), this locative focusses on the internal structure of the situation of being present in a certain location with the end point of this situation (being present in a certain location) either removed or not in focus. The form *et* is more common in my corpus with 77 attestations compared to eight attestations of locative *es*. Two examples of locative *es* are given in (54) and (55) below.⁶

- (54) *aan moonḑ=ees es nana-f ia, fe? munif.*
 child male=one IPFV.LOC inside-0GEN IDEM still young
 ‘A young man inside here, (he’s) still young.’ 130821-1, 0.38 🔊
- (55) *m-aamḑ=ee =t, m-iit=ee es mee?*
 1PX/2-look.for=3SG.ACC =SUB 1PX/2-see=3SG.ACC IPFV.LOC where
 ‘When you look for him, where will you find him?’ 130925-1, 1.24 🔊

⁶In other varieties of Meto, including Amfo’an and Baikeno, the form *es* is more common. In my Ro’is Amarasi data this locative has the form *ek/et* with *ek* most common. Ro’is *ek* seems to function as a more general locative, rather than specifically imperfective.

To summarise, the forms *esa/ees* and similar *es* have a number of functions. When *esa/ees* is a number enclitic it functions as the numeral ‘one’ or as an indefinite marker and it triggers M-forms. In other situations it is an independent word and does not trigger M-forms.

6.3 Attributive modification

Having established the formal criteria by which we can identify a word class of nominals, I now discuss the structure of the Amarasi nominal phrase and the use of syntactic M-forms. The structure of the Amarasi nominal phrase is given in (56) below, following the conventions of a version of X-bar theory (Bresnan et al. 2016). The specifier of the nominal phrase can be filled by a possessive phrase (§6.4.3) and the adjunct position can be filled by another nominal. Non-final nominals below the level of \bar{N} obligatorily occur in the M-form.

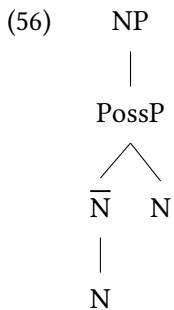

After a discussion of the basic facts of attributive nominal phrases I discuss a number of specific cases. Most phrases involving loans (§6.3.1) and proper nouns (§6.3.2) behave identically to other nominal phrases and provide additional evidence that the use of M-forms is a productive process in Amarasi. Nominal phrases with a conventionalised meaning are discussed in §6.3.3.

In §6.3.4 I discuss phrases with multiple attributive modifiers in which every nominal except the final one occurs in the M-form. I conclude my discussion with the use of M-forms before ordinal numbers and the use of U-forms before cardinal numbers (§6.3.5). This provides strong evidence that M-forms in attributive phrases cannot be analysed as phonologically conditioned.

A number of attributive nominal phrases extracted from my corpus are given in Table 6.5. The syntactic structure of one of these, *faut muti?* ‘white stone’, is given in (57) below.

6 Syntactically driven metathesis

Table 6.5: Attributive nominal phrases

N_1 + N_2	Phrase	N_1 + N_2	Phrase
<i>afu</i> + <i>me?e</i>	<i>auf me?e</i>	'earth' + 'red'	'red earth'
<i>anah</i> + <i>mone</i>	<i>aan mone</i>	'child' + 'male'	'son'
<i>atoni?</i> + <i>reko</i>	<i>atoin reko</i>	'man' + 'good'	'good man'
<i>bare</i> + <i>ko?u</i>	<i>baer ko?u</i>	'place' + 'big'	'big place'
<i>baba-f</i> + <i>mone</i>	<i>baab mone</i>	'FZ/MB' + 'male'	'MB'
<i>fatu</i> + <i>muti?</i>	<i>faut muti?</i>	'stone' + 'white'	'white stone'
<i>kase</i> + <i>muti?</i>	<i>kaes muti?</i>	'foreign' + 'white'	'European'
<i>kaut</i> + <i>sufa?</i>	<i>kau sufa?</i>	'papaya' + 'blossom'	'papaya blossom'
<i>manus</i> + <i>fua-f</i>	<i>maun fua-f</i>	'betel' + 'fruit'	'betel pepper'
<i>mata-f</i> + <i>tei</i>	<i>maat tei</i>	'eye' + 'faeces'	'rheum'
<i>mu?it</i> + <i>fui</i>	<i>mui? fui</i>	'animal' + 'wild'	'wild animal'
<i>rasi</i> + <i>re?uf</i>	<i>rais re?uf</i>	'matter' + 'bad'	'evil matter'
<i>ri?ana?</i> + <i>munif</i>	<i>ri?aan munif</i>	'child' + 'young'	'young child'
<i>utan</i> + <i>kaut</i>	<i>uut kaut</i>	'vegetable' + 'papaya'	'papaya leaves'

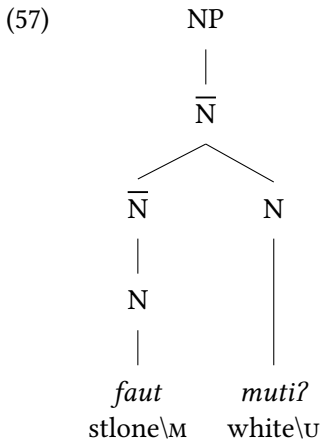

The use of attributive nominal phrases is highly productive in Amarasi and speakers freely innovate new ones in a similar way to the use of adjective and noun phrases in English. Such examples show that the use of M-forms in attributive nominal phrases in Amarasi is a productive morphological process. One example is given in (58) below. In (58a) the speaker introduces the nominal *tani*

‘rope’, what kind of rope is then specified in (58b) with the complex nominal *tain tuni*; it is a rope made from a gewang palm.

- (58) Making a magical sign to protect one’s garden from theft: 120923-2 
- a. *ja, n-pake ?soko?, n-heer tani.*
 yes 3-use sign 3-pull rope\U
 ‘Yes, (he) uses a sign. Ties a rope.’ 1.37
- b. *na-tuu? tain tuni, tua, =ma*
 na-tu?u tani tuni tua =ma
 3-make.knot rope\M gewang,palm\U ADDR =and
 ‘(He) ties up a rope made from gewang palm (leaves) and ...’ 1.39

Another two examples are given in (59) below which is part of a story about a kind of curse: the *biku* curse. In (59a) we find the nominal phrase *rais biku* ‘the matter of *biku*’. This nominal is elaborated on in (59b) by the noun phrase *moa? biku*, ‘the doing/practice of *biku*’.

- (59) Casting the *biku* curse: 120923-1 
- a. *iin n-nao n-ok re? rais biku re? ia,*
 ini n-nao n-oka re? rasi biku re? ia
 3SG 3-go 3-with TOP matter\M curse\U REL 1DEM
 ‘He went along with this matter of cursing (people),’ 0.53
- b. *moa? biikgw=ii*
 mo?e biku=ii
 deed\M curse\M=1DET
 ‘the practice of cursing.’ 0.55

6.3.1 Loan nominals

More evidence that the use of M-forms is productive in Amarasi comes from the behaviour of loanwords. When one or more parts of an attributive phrase is a loanword, the first nominal usually takes the expected M-form according to the normal rules discussed in Chapter 4.

Two examples of nominal phrases involving assimilated loans are given in (60) and (61) below. In (60) the second part of the phrase *rais pirsai-t* ‘matters of belief’ is a loan from Malay *percaya* ‘believe’ (ultimately from Sanskrit *pratyeti*). Similarly in (61) the second part of the nominal phrase *amnaah bubur* ‘porridge eater’ is a loan from Malay *bubur* ‘porridge’.

6 Syntactically driven metathesis

- (60) *hai mi-noni? n-ok, a|n-ma-toom n-ok*
hai mi-noni? n-oka n-ma-toma n-oka
 1PX 1PX/2PL-learn 3-with 3-RECP-about 3-with
hiit rais pirsai-t.
hiti rasi pirsai-t
 1PI matter\M believe-NML
 ‘We learnt about matters to do with (our) belief.’ 130921-1, 1.35 🔊
- (61) *au ka= amna-ah bubur =kau =fa!*
au ka= amna-ha-t bubur =kau =fa
 1SG NEG= NML-eat\M porridge\U =1SG.ACC =NEG
 ‘I don’t eat porridge!’ (*lit.* ‘I’m not a porridge eater!’) 130825-6, 17.02 🔊

In (62) below both elements of the nominal phrase *oot dinas* ‘work car’ are loans. The first element *oto* is from Dutch *auto* ‘car’ and *dinas* is ultimately from Dutch *dienst* [di:nst]. The nominal *dinas* is furthermore unassimilated, as Amaras does not have the phoneme /d/. Nonetheless, the first nominal of this nominal phrase occurs in the expected M-form and the second nominal also occurs in the M-form with consonant-vowel metathesis as expected before enclitics (see Chapter 5).

- (62) *iin n-eik iin oot diins=ii =m na-sae-ba? =kau.*
ini n-eki ini oto dinas=ii =ma na-sae-ba? =kau
 3SG 3-bring 3SG car\M service\M=1DET =and 3\TR-go.up-TR =1SG.ACC
 ‘He brought his work car and picked me up.’ 130825-6, 13.28 🔊

In (63) the entire nominal phrase *kapaal desa* ‘village head’ is a loan from Malay *kepala desa*. Nonetheless, the first part is in the M-form, resulting in metathesised *kapaal* from *kapala*. Furthermore, neither part of this nominal phrase has been phonologically assimilated with both of the non-native consonants /l/ and /d/ remaining unchanged.⁷

- (63) *natun niim on kapaal desa n-ok ina staaf=ein=ee.*
natun nima on kapala desa n-oka ina staaf=ein=ee
 thousand five IRR.LOC head\M village\U 3-with 3SG staff=PL=3DET
 ‘Five thousand (goes) to the village head and his staff.’ 130926-1, 0.45 🔊

Similarly in (64) below the nominal phrase *baas Indonesia* ‘Indonesian language’ is a loan from Kupang Malay *basa Indonesia*. Nonetheless the first part

⁷The phonemes /d/ and /l/ are assimilated as /r/ in naturalised loans (§3.2.2.3).

of the nominal phrase surfaces in Amarasi in the expected M-form with final consonant-vowel metathesis of putative underlying *basa*.

- (64) *kaah, on re? nati? =te, siin n-nena =ha Uisneno iin kaibn=ii,*
kaah on re? nati? =te sini n-nena =ha Uisneno ini kabin=ii
 NEG like TOP normal =SUB 3PL 3-hear =only God 3SG word=1DET
n-eki =ha uab, baas Indonesia.
n-eki =ha uaba basa Indonesia
 3-use =only speech\M language\M Indonesia
 ‘Unlike normal, when they just hear God’s word in Indonesian.’ 130920-1,
 4.20 🗣️

6.3.1.1 Loans without M-forms

Although many loan words are treated the same as native vocabulary when they occur in an attributive nominal phrase, there are some loanwords which are not. Notably, consonant-final loanwords do not have M-forms in attributive phrases.

One example is given in (65) below with the nominal phrase *tukan hau* ‘carpenter’, in which the first nominal occurs in the U-form rather than expected **tuuk hau*. Amarasi *tukan* is borrowed from Malay *tukang* ‘artisan’. I have an additional five examples of the form *tukan* as the first nominal in an attributive phrase in my corpus, three of *tukan hau* as in example (65), and two of *tukan besi* ‘blacksmith’ (cf. Malay *tukang besi*).⁸

- (65) *na, au u-teenb=ii, au ?-ak of ai? he ?-bi skoor*
na au u-tenab=ii au ?-ak of ai? he ?-bi skora
 well 1SG 1SG-think=1DET 1SG 1SG-say sure or IRR 1SG-RL.LOC school
tuukn=ii, tukan hau
tukan=ii tukan hau
 artisan\M=1DET artisan wood

‘Well, I thought I would surely be at the artisan school, carpentry.’
 130907-3, 1.23 🗣️

⁸Another example is the nominal *skora* ~ *skoor* ‘school’. There is variation in as to whether the root is \sqrt{skora} from which the M-form *skoor* is regularly derived, or whether the root is consonant-final \sqrt{skoor} for which no M-form can be derived (the expected M-form would be **skoo*). Such variation is even found in the speech of single speakers. This may be a case of borrowing from different sources; Dutch *school* /sɣo:l/ > *skoor* and Portuguese *escola* /ɛskɔla/ > *skora*. (The form *skora* could also be via intermediate Malay which has *sekolah* /səkolah/.) The verbal equivalent of this nominal normally has the U-form *na-skora* ‘(s/he) studies’ and the M-form *na-skoor*. These forms could be borrowing from the Dutch verb *scholen* [sɣo:lə].

6 Syntactically driven metathesis

Despite the fact that consonant-final loan nominals do not have M-forms before attributive modifiers, they *are* attested with M-forms before vowel-initial enclitics. One example has already been given in (65) in which the form *tuukn=ii* ← *tukan + =ii* occurs.

This provides evidence that the metathesis before vowel-initial enclitics is a different kind of metathesis to metathesis in nominal attributive phrases. In Chapter 5 I analysed metathesis before vowel-initial enclitics as an automatic phonologically conditioned process. This phonological process applies to all words without regard to whether they are loans or not.

Morphological metathesis, on the other hand, has phonotactic restrictions on the kinds of loans it applies to. Consonant-final loans do not usually undergo morphological metathesis. This phonotactic restriction also occurs among verbs in Amarasí. As discussed in §6.7.1, consonant-final verbs followed by an attributive modifier usually occur in the U-form.

6.3.2 Proper names

Combinations of two personal names, typically a first name and a family/clan name, are usually treated as an attributive nominal phrase with the first name in the M-form. One example is given in (66b) below, in which the name *Tefa?* occurs in the M-form before *Unus*, and in the U-form without a modifier.

- (66) a. *oke? =te re? a-tupa-s re? ia n-teek=ee =t n-ak:*
oke? =te re? a-tupa-s re? ia n-teka=ee =te n-ak
 after.that REL NML-sleep-NML REL IDEM 3-call=3SG.ACC =SUB 3-QUOT
 ‘After that the one who is asleep (dead) here they called her.’
- b. *bi Teef Unus, ai? bi Tefa?*
bi Tefa? Unus ai? bi Tefa?
 Ms. Tefa'\M Uunus\U or Ms. Tefa'\U
 ‘Tefa' Unus or (just) Tefa!’ 130821-1, 6.03 🔊

In example (67a) below, the first time the person is mentioned only his first name is given. When the speaker clarifies who exactly this *Tinus* is by supplying a clan name in (67b), the first name occurs in the M-form.

- (67) a. *re? au u-toon ia =t, nai? Tinus a/n-palaŋ nua.*
re? au u-tona ia =te nai? Tinus n-palaŋ nua
 REL 1SG 1SG-tell IDEM =SUB Mr. Tinus\U 3-crossbeam two
 ‘I told (him) this. Tinus trapped two (cows).’ 130925-1, 2.02 🔊

- b. *Tiun Nuban n-palaŋ nua.*
 Tinus Nuban n-palaŋ nua
 Tinus\M Nuban\U 3-crossbeam two
 ‘Tinus Nuban trapped two.’ 2.04

A similar example is given in (68) below, in which the name *Da?i* ‘David’ occurs in the U-form when on its own, but in the M-form when the family name of the referent follows.

- (68) a. *n-ok nai? Manase, nai? Da?i*
 n-oka nai? Manase nai? Da?i
 3-with Mr. Manasseh Mr. David\U
 ‘With Manasseh, (and) David,’ 130907-5, 0.21 
- b. *Dai? Saebeis?=ii n-ok nai? Manase Bani.*
 Da?i Saebes?=ii n-oka nai? Manase Bani
 David\M Saebes='\M=1DET 3-with Mr. Manasseh Bani\U
 ‘David Saebes’ with Manasseh Bani.’ 0.29

Note, however, that in example (68b) the name *Manase* ‘Manasseh’, does *not* occur in the M-form when the family name *Bani* follows. A search of my corpus reveals many other instances in which a first name followed by a family name does not occur in the expected M-form. A selection of other examples include: *Paulus Ora?*, *Harun Bani* and *Saul Bani*. In most such instances, the first name is a non-nativised Biblical name.⁹

6.3.3 Lexicalised attribution

A nominal phrase can have a conventionalised, lexicalised meaning. A sample of such nominal phrases is given in Table 6.6 below. In all such examples the first nominal takes the expected M-form in the same way as other nominal phrases. In this book the elements of a conventionalised phrase are separated by an underscore rather than a space.

One possible analysis of such phrases would be to propose that they are instances of compounding, with the entire phrase consisting of only a single nominal. This analysis is shown in (69a) below, for *koor_maka?* ‘sparrow’. Alternately, such phrases can be analysed as consisting of two independent nominals, as shown in (69b).

⁹While the name *Da?i* in (68a) is Biblical, it *is* (semi-)nativised. The form <Da'i> /da?i/ is associated with Timor and has its origins on Rote island. It is perceived by Amarasi speakers to be a Timorese name. The Indonesian (but non-Timorese) form of the name *David* is *Daud*.

6 Syntactically driven metathesis

Table 6.6: Lexicalised nominal phrases

$N_1 + N_2$	N_1	+	N_2	Phrase	Phrase
<i>fafi + tai-f</i>	‘pig’	+	‘guts’	<i>faif_tai-f</i>	‘sea anemone’
<i>knaa? + kase</i>	‘bean’	+	‘foreign’	<i>knaa_kase</i>	‘peanuts’
<i>knafo + oe</i>	‘mouse’	+	‘water’	<i>knaof_oe</i>	‘mole cricket’
<i>koro + maka?</i>	‘bird’	+	‘rice’	<i>koor_maka?</i>	‘sparrow’
<i>?bibib + kase</i>	‘goat’	+	‘foreign’	<i>?biib_kase</i>	‘sheep’
<i>me?e + mainuki?</i>	‘red’	+	‘unripe’	<i>mee?_mainuki?</i>	‘pink’
<i>mone + fe?u</i>	‘male’	+	‘new’	<i>moen_fe?u</i>	‘son-in-law’ [†]
<i>okam + asu</i>	‘gourd’	+	‘dog’	<i>ook_asu</i>	‘choko, chayote’
<i>paha + meto?</i>	‘country’	+	‘dry’	<i>paah_meto?</i>	‘Timor’
<i>uaba? + meto?</i>	‘speech’	+	‘dry’	<i>uab_meto?</i>	‘Meto’

[†] *moen_fe?u* means both ‘son-in-law’ (DH) and ‘opposite sex sibling’s son’ (ZS [m.s.], BS [w.s.]).

- (69) a. [NP [N *koor* *maka?*]]
 bird\M rice\U
 ‘sparrow’
- b. [NP [N *koor*] [N *maka?*]]
 bird\M rice\U
 ‘sparrow’

Apart from the conventionalised meaning of such phrases, there is no evidence that they have a different syntactic status to nominal phrases with a compositional meaning. I return to the possibility of analysing all attributive phrases in Amarasi as compounds in §6.8.

6.3.4 Multiple modifiers

It is possible for a nominal phrase to contain multiple attributive modifiers. This can occur in two ways. Firstly, the head nominal can be modified by two modifiers, as shown in (70) below, or the attributive modifier can itself consist of a modified nominal, as shown in (71) below. The syntactic head(s) which occur in the M-form are indicated by a box. For each kind of structure both the first and second nominals occur in the M-form as expected.

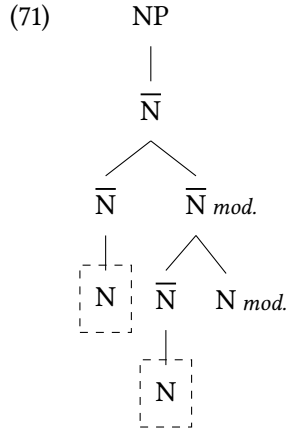
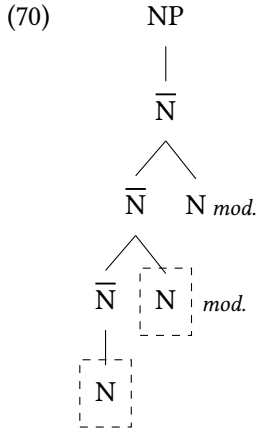

Examples of nominals followed by multiple modifiers are given in Table 6.7. Each of these nominals has the structure $[[[N_1]N_2]N_3]$ with an attributive phrase modified by a third nominal. This structure corresponds to the tree given in (70) above. Of these, the first two have at least partially compositional meanings while the third has a lexicalised meaning.

Table 6.7: Nominals with multiple attributive modifiers: $[[[N_1]N_2]N_3]$

$[[[N_1]$	$N_2]$	$N_3]$	Phrase	
<i>utan</i>	+ <i>kaut</i>	+ <i>sufa?</i>	→ <i>uut kau sufa?</i>	‘papaya blossom vegetable as a vegetable’
<i>?bibi</i>	+ <i>kase</i>	+ <i>ana?</i>	→ <i>?biib_kaes ana?</i>	‘lamb’
goat	foreign	baby		
<i>koro</i>	+ <i>kae</i>	+ <i>muti?</i>	→ <i>koor_kae muti?</i>	‘Yellow-crested bird Cuckatoo’
bird	cry	white		

A number of nominal phrases with the structure $[N_1[[N_2]N_3]]$ are given in Table 6.8 below. In such phrases the second two nominals form a phrase which modifies the first nominal, thus corresponding to tree (71) above. All of the nominal phrases in Table 6.8 have a lexicalised meaning.

The structure of two nominal phrases with multiple modifiers are given in (72) and (73) below to illustrate their differing structures. The structure of *?biib kaes ana?* ‘lamb’ is given in (72) and that of *oet biɟae suna* ‘pickaxe’ in (73).

6 Syntactically driven metathesis

Table 6.8: Nominals with multiple attributive modifiers: $[N_1[[N_2]N_3]]$

$[N_1$		$[[N_2]$	$N_3]$			
<i>ote?</i>	+	<i>biɕʒae</i>	+ <i>suna</i>	→	<i>oet_biɕʒae suna</i>	‘pickaxe’
hoe		cow	horn			
<i>unus</i>	+	<i>fua?</i>	+ <i>koʔu</i>	→	<i>uun fua koʔu</i>	‘Holland chilli’
chilli		fruit	big			
<i>simah</i>	+	<i>tai?</i>	+ <i>boko</i>	→	<i>siim_tai boko</i>	‘k.o. large green katydid’
katydid		belly	curved			
<i>unus</i>	+	<i>fua?</i>	+ <i>mnutu?</i>	→	<i>uun fua mnutu?</i>	‘bird’s eye chilli’
chilli		fruit	fine			
<i>kauna?</i>	+	<i>fee</i>	+ <i>mnasi?</i>	→	<i>kaun_fee_mnasi?</i>	‘woodlouse’
creature		wife	old			

(72)

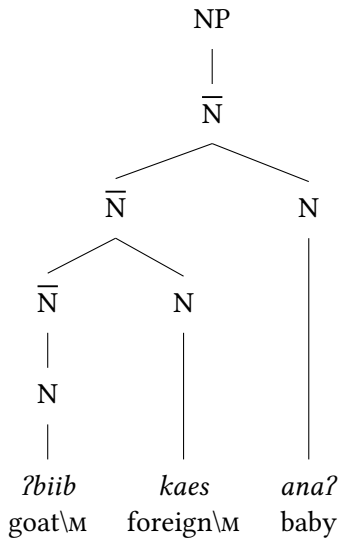

(73)

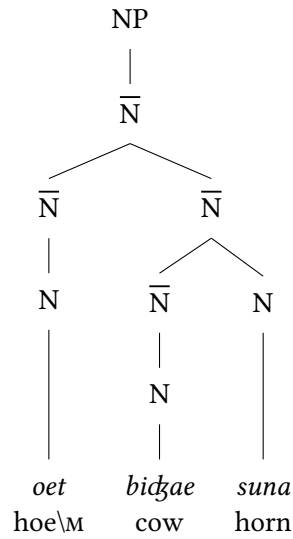

The largest attributive nominal phrase in my dictionary is *anah* ‘child’ + *mone* ‘male’ + *a-heti-t* ‘NML-stop-NML’ + *susu* ‘milk’ → *aan moen aheit susu* ‘youngest son’, literally ‘male child (who) stopped the milk’. This nominal phrase has the structure $[[[aan] [moen]] [[aheit] [susu]]]$, with the second nominal modifying the first, the fourth modifying the third, and the final attributive phrase modifying the first attributive phrase.

As with attributive phrases consisting of two nominals, the use of multiple modifiers is highly productive in Amarasi. Two textual examples of the structure $[[[N_1]N_2]N_3]$, with a single nominal modified by multiple modifiers are given in (74) and (75) below.

- (74) *au ?-sao ne? ri?aan?=ee, aan feat ko?u.*
 au ?-sao ne? ri?an?a=ee anah fetu ko?u
 1SG 1SG-marry TOP child\M=3DET child\M female\M big\U
 ‘I married the daughter, the eldest daughter.’ 130907-3, 12.15 🔊
- (75) *au he u-toon n-ok meup reen abit, n-bi Nekmese?.*
 au he u-tona n-oka mepu rene abit n-bi Nekmese?
 1SG IRR 1SG-tell 3-with work\M field\M inhabitant 3-RL.LOC Nekkese’
 ‘I want to talk about how an inhabitant of Nekkese’ farms.’ (*lit.* ‘inhabitant field work’) 120715-2, 0.25 🔊

Two textual examples of the structure $[N_1[[N_2]N_3]]$, where a nominal modified by another nominal in turn modifies another nominal, are given in (76) and (77).

- (76) *n-naka?fatu=n n-bi re? rais moa? reu?f=ii.*
 n-naka?fatu=n n-bi re? rasi mo?e re?uf=ii
 n-stubborn=PL 3-RL.LOC TOP matter\M deed\M bad\M=1DET
 ‘They’re stubborn in the matter of this evil practice.’ 120923-1, 0.47 🔊
- (77) *ta-tenab on re? hiit atoin a-moa? reu?f=ii =te,*
 ta-tenab on re? hiti atoni a-mo?e-t re?uf=ii =te
 0-think like TOP 1PI man\M NML-do\M bad\M=1DET =SUB
 ‘When you think like (this) you’re a person who is an evildoer.’ 120923-2, 6.47 🔊

The structure of the nominal phrase *meup reen abit* in (75) above is given in (78). Similarly, the structure of the phrase *atoin amoa? reu?f=ii* in (77) is given in (79). (Metathesis of the final nominal in this phrase is induced by the following enclitic, see Chapter 5)

6 Syntactically driven metathesis

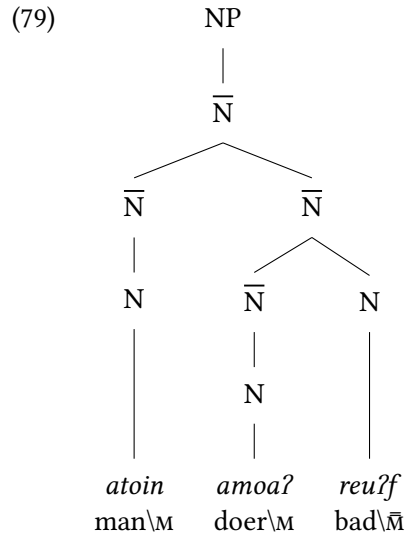
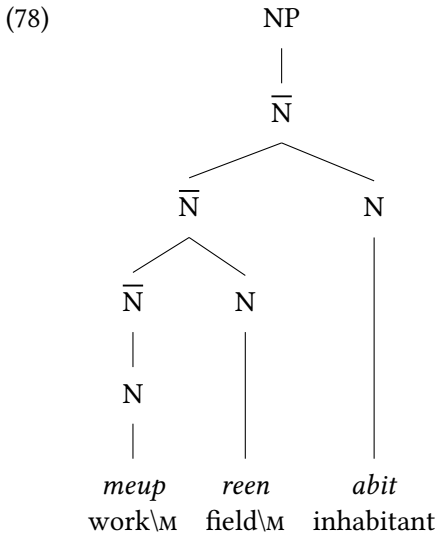

The longest string of attributive nominals I have so far encountered occurs in the Amarasi Bible translation. This is in Genesis 11:5 in the description of the tower of Babel. This passage is given in (80) below, with the structure of the nominal phrase given in (81). In this example six nominals occur in a single nominal phrase.

- (80) *onai =m Uisneno n-saun neem ma n-noon kota =ma*
onai =ma Uisneno n-sanu nema ma n-noon kota =ma
 and.so God 3-descend 3\come and 3-walk.around city\U =and
koot ma-?uim faut ma-ktuta mnaun a-?rata-s
kota ma-?umi-? fatu ma-ktuta? mnanu? a-?rata-s
 city\M PROP-house\M stone\M PROP-stack\M long\M NML-elevate\U-NML
re? mansian=ein naan na-feen-?=ee.
re? mansian=eni naan na-fena-?=ee.
 REL human=PL 2DEM 3\TR-rise-TR=3SG.ACC
 ‘And so God came down and walked around (in) the city and the high,
 tall residential city (made of) stacked stones which those humans were
 building.’ Genesis 11:5

(81)

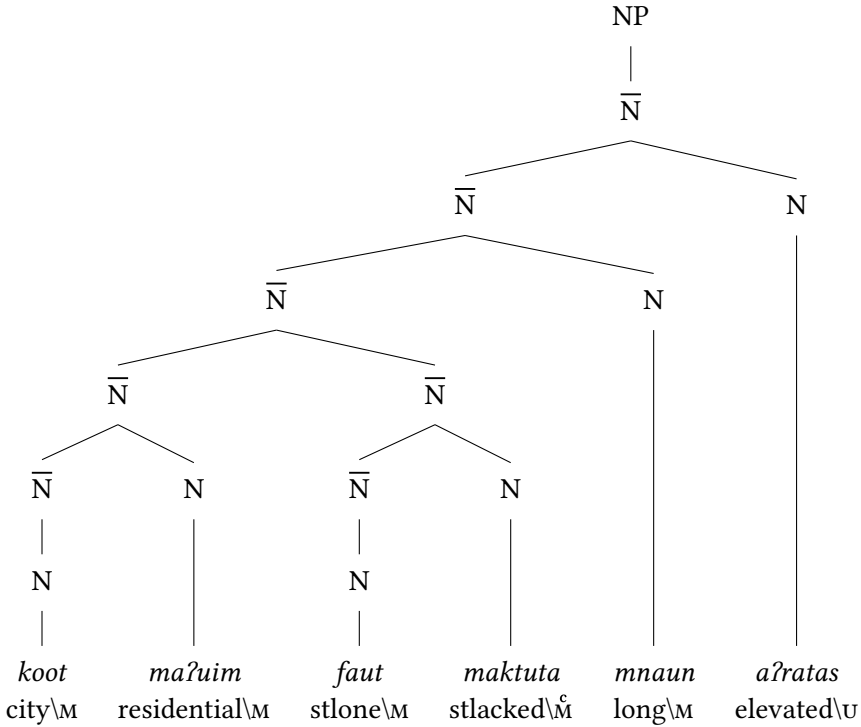

6.3.5 Ordinal numbers

Nominals followed by a cardinal number take U-forms in Amarasi, while there is one set of ordinal numbers which induce M-forms on the head noun. Nonetheless, both kinds of phrases have identical stress patterns, and this provides some of the most unambiguous evidence that metathesis before attributive modifiers in Amarasi cannot be analysed as phonologically conditioned as has been proposed for both Rotuman (§2.3.2) and Leti (§2.3.6).

Amarasi has two sets of ordinal numbers. One set is used specifically for days of the week and months of the year, while the other set is used in other instances. The ordinal numbers used for days of the week and months of the year are mostly formed from the cardinal numbers through addition of a glottal stop, either as a suffix or as an infix and obligatorily occur with M-forms. The general purpose ordinal numbers occur after *noo* and take a suffix *-n* and occur with U-forms.¹⁰ The Amarasi cardinal and ordinal numbers are given in Table 6.9.

¹⁰The form *noo* is probably cognate with the word *noʔo* ‘leaf’ < Proto-Malayo-Polynesian *dahun. The suffix *-n* is probably connected with the 3SG.GEN suffix *-n*.

Table 6.9: Amarasi numerals

No.	Cardinal	Ordinal [†]	Ordinal [‡]
1	=ees, mese?	mese?	noogw=ees
2	nua	nua?	noo nua-n
3	tenu	tenu?	noo tenu-n
4	haa	haa?	noo haa-n
5	nima	nima?	noo nima-n
6	nee	ne?e	noo ne?e-n
7	hitu	hitu?	noo hitu-n
8	fanu	fanu?	noo fanu-n
9	seo	se?o	noo seo-n
10	bo?=ees	bo?	noo bo?

[†] Used for weekdays and months of the year (take M-forms).

[‡] Used for more other purposes (take U-forms).

The ordinal numbers used for counting days and months are nominals and thus induce M-forms on the preceding nominal. Four examples of an attributive ordinal number are given in (82) and (83) below. Phrasal stress is indicated in each example with an acute accent. In both instances phrasal stress falls on the penultimate or final vowel of each intonation group.

- (82) [nɛɛn hɛ? ɛfi nɛ tɛ: || am fɛrdi ka n-ɔkɛ f]
nean haa-? a*fi*_naa =te, aam Ferdi ka= n-oka =f.
 neno¹¹ haa-? a*fi*_naa =te ama Ferdi ka= n-oka =fa
 day\M four-ORD yesterday =SUB father\M Ferdi NEG= 3-with\U =NEG
 ‘Thursday, yesterday, father Ferdi didn’t join (us).’ 130920-1, 2.11 🔊
- (83) [fɔn hiʈɔ fɔn fanɔ kɛ t fɔn sɛ?ɛ]
fuun hitu-?, *fuun* fanu-? kah =t *fuun* se<?>a.
 funan hitu-? funan fanu-? kah =te funan se<?>o
 moon\M seven\U-ORD moon\M eight-ORD NEG =SUB moon\M nine<ORD>
 ‘July (or) August, if not September.’ (*lit.* ‘seventh moon, eighth moon if not ninth moon.’) 120715-2, 0.37 🔊

¹¹The rule of Kotos vowel height dissimilation (§3.2.1.4.2) has applied in (82), yielding metathesised *nean* rather than ‘expected’ *neon*.

Cardinal numbers do not induce M-forms on the nominal they follow. Two textual examples of a U-form nominal followed by a cardinal numeral are given in (84) and (85) below. As in examples (82) and (83) above, phrasal stress falls on the final or penultimate vowel of the intonation group.

- (84) [hej mɾes sin nɛnɔ hɛ́]
*hai m-rees =siin **nenɔ** haa.*
 1PX 1PX/2-read\M =3PL day\U four
 ‘We read them for four days.’ 130920-1, 3.29 🔊

- (85) [tʷəfɛs namajkɛ nɔk kiɪ fɔnɛn nʷɛ =m
*tuaf=ees na-maika? n-ok =kiit **funan** nua =m*
tuaf=esa na-maika? n-oka =kiti funan nua =ma
 person=one 3-stay 3-with =1PL.ACC moon\U two =and
 of hi ɛs mɔ́kɛn]
of hii ees m-oka=n.
of hii esa m-oka=n
 later 2PL one 1PX/2-with=PL
 ‘One person is staying with us for two months and later you’ll be with
 the ones with him.’ 130821-1, 1.18 🔊

The examples in (82)–(85) above all have very similar stress patterns. The penultimate or final phonemic syllable of each intonation group bears stress, and yet M-forms occur before ordinal numbers and U-forms before cardinal numbers.

As discussed previously in §4.4.2, this behaviour is shown even more explicitly, by the nominal *nenɔ* ‘day’ followed by each of the cardinal and ordinal numbers 1–6, as given in Table 6.10. The only phonological difference between each pair of phrases is metathesis of the final syllable of the nominal *nenɔ* ‘day’, and (when applicable) the presence of a glottal stop to form an ordinal number.

While different prosodic patterns may have contributed to the diachronic development of Amarasi metathesis, this analysis is no longer possible for the synchronic data. Metathesis is a morphological device used to signal the presence of an attributive modifier. Syntactic structures for the nominal and numeral phrases *nenɔ mese?* ‘one day’ and *neon mese?* ‘first day (Monday)’ from Table 6.10 have already been given in (1) and (2) at the beginning of this chapter.

6.3.6 Summary

M-forms are used in the nominal phrase in Amarasi for all non-final nominals below the level of \bar{N} . M-forms are a construct form which mark the presence of

Table 6.10: Amarasi nominals and numerals

Underlying	Phonetic		gloss
<i>nenō mese?</i>	[,nɛnɔ'mɛsɛʔ]	◀▶	'a single day' [†]
<i>neon mese?</i>	[,nɛ.ɔn'mɛsɛʔ]	◀▶	'first day (Monday)' [‡]
<i>nenō nua</i>	[,nɛnɔ'nɔ.ɐ]	◀▶	'two days'
<i>neon nua-?</i>	[,nɛ.ɔ'n:ɔ.ɐʔ]	◀▶	'second day (Tuesday)'
<i>nenō teun[#]</i>	[,nɛnɔ'tɛ.ɔn]	◀▶	'three days'
<i>neon tenu-?</i>	[,nɛ.ɔn'tɛnɔʔ]	◀▶	'third day (Wednesday)'
<i>nenō haa</i>	[,nɛnɔ'ha:]	◀▶	'four days'
<i>neon haa-?</i>	[,nɛ.ɔn'ha:ʔ]	◀▶	'fourth day (Thursday)'
<i>nenō niim</i>	[,nɛnɔ'ni:m]	◀▶	'five days'
<i>neon nima-?</i>	[,nɛ.ɔ'n:i:mɐʔ]	◀▶	'fifth day (Friday)'
<i>nenō nee</i>	[,nɛnɔ'nɛ:]	◀▶	'six days'
<i>neon ne<ʔ>e</i>	[,nɛ.ɔ'n:ɛʔɛ]	◀▶	'sixth day (Saturday)'

[†] The phrase *nenō mese?* has the sense of 'a single day'. The normal phrase for 'one day' would be *neengw=ees*, from *nenō* + *=ees*.

[‡] The normal reference for the phrases with ordinal numbers is to the days of the week, with *neon mese?* 'first day' being Monday and *neon ne<ʔ>e* 'sixth day' being Saturday. The normal phrase for Sunday is *nenō krei* 'day + church'. The phrase *neon hitu-?* 'seventh day' is attested twice in the Amarasi Bible translation in Genesis 2. This shows that the phrases with ordinal numbers are not just completely lexicalised phrases.

[#] The default form for cardinal numerals is the M-form.

a dependent modifier. In §6.4–§6.6 below I discuss nominal structures in which M-forms conditioned by syntax do not occur. These structures include possession (§6.4), modifiers which are not nominals (§6.5) and equative clauses (§6.6).

6.4 Possession

In Amarasi the possessor precedes the thing possessed, with an optional possessive pronoun occurring between the two. Possessive phrases do not induce M-forms on either the possessor or the possessed nominal. I analyse the possessive phrase as occurring as the specifier of the nominal phrase, as indicated in (86) below.

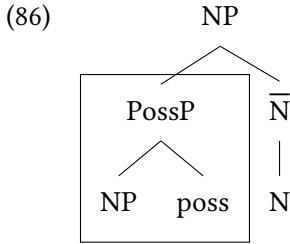

A simple case of possession is given in (87) below, with the syntactic structure of the nominal phrase given in (88).

- (87) *nai? Yohanis iin surat re?, a-hunu-t*
 Mr. John 3SG paper\U REL NML-firstNML
 ‘John’s book which is the first.’

130921-1, 0.50 🔊

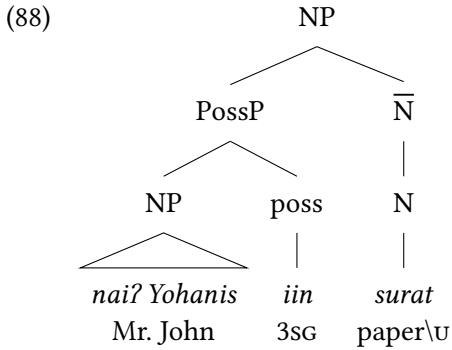

After a brief discussion of the details of possession in Amarasi, including determiner enclitics to mark the thing possessed (§6.4.1) and genitive suffixes (§6.4.2), I discuss the syntactic structure of possession in more detail in §6.4.3.

6.4.1 Possessum determiners

When the thing possessed is not indicated by a full nominal phrase, it is referenced by one of the enclitic determiners =*ii*, =*ana*/=*aan*, =*ee* or =*aa* which attach directly to the pronoun indexing the possessor. (See §6.5.2 for the syntactic position of these determiners.) When the possessum is plural, it is referenced by the enclitic =*n* on CV# final pronouns and either =*nu* or =*ngwein* on VV# final pronouns.¹² A plural possessum can further be referenced by an enclitic.

¹²As discussed in §5.6 =*ngwein* is analysable at least historically as a combination of =*nu* and =*ein* with regular insertion of /gw/.

6 Syntactically driven metathesis

The ways in which a possessum which is not expressed by a full noun phrase is encoded in Amarasi are summarised in Table 6.11 below with the determiner =*aa* ‘0DET’ where appropriate. These constructions are one of the few in which the double vowel sequence of the pronouns *iin* ‘3SG’, *siin* ‘3PL’, and *hiit* ‘1PL.INCL’ are stressed and thus realised as a full long vowel. Two examples of singular possessums encoded with a determiner are given in (89) and (90) below.

Table 6.11: Encoding of unexpressed possessums

Possessor		SG Possessum	PL Possessum		
1SG	<i>au</i>	<i>aagw=aa</i>	<i>au=nu</i>	<i>au=ηgwein</i>	<i>au=ηgw=aa</i>
2SG	<i>hoo</i>	<i>hoogw=aa</i>	<i>hoo=nu</i>	<i>hoo=ηgwein</i>	<i>hoo=ηgw=aa</i>
3SG	<i>iin</i>	<i>iindz=aa</i>	<i>ini=n</i>		<i>iin=n=aa</i>
1PL.EXCL	<i>hai</i>	<i>haadz=aa</i>	<i>hai=nu</i>	<i>hai=ηgwein</i>	<i>hai=ηgw=aa</i>
1PL.INCL	<i>hiit</i>	<i>hiitdz=aa</i>	<i>hiti=n</i>		<i>hiit=n=aa</i>
2PL	<i>hii</i>	<i>hiidz=aa</i>	<i>hii=nu</i>	<i>hii=ηgwein</i>	<i>hii=ηgw=aa</i>
3PL	<i>siin</i>	<i>siindz=aa</i>	<i>sini=n</i>		<i>siin=n=aa</i>

- (89) *bait hoogw=ii n-moni =t, bait hoo on ne? au.*
baiti hoo=ii n-moni =te baiti hoo on ne? au
 actual 2SG\̄M=1DET 3-live =SUB actual 2SG like TOP 1SG
 ‘Actually, while yours is alive it’s like me.’ 130909-6, 2.54 🗣️
- (90) *ehh, n-fain=n=ena? nai? Rius iindz=aan n-fani?*
n-fani=n=ena nai? Rius ini=ana n-fani
 3-return=PL=INCEP Mr. Lius 3SG\̄M=2DET 3-return
 ‘They’ve returned now? Has Lius’s (child) returned?’ 130909-6, 3.23 🗣️

I have so far only encountered one non-elicited example of a plural possessum indexed with =*nu* and no other determiner. This comes from the Amarasi Bible translation and is given in (91) below, followed by an elicited example in (92).

- (91) *iin nui-f=ein huma? mese? n-ok au=nu.*
 3SG bone-0GEN=PL kind one 3-with 1SG=PL
ma iin sisi-n huma? mese? n-ok au sisi-k.
 and 3SG flesh-3SG.GEN kind one 3-with 1SG flesh-3PL/1GEN
 ‘Her bones are the same as mine. And her flesh is the same as my flesh.’
 ‘This is now bone of my bones and flesh of my flesh.’ Genesis 2:23

- (92) a. *sekau iin=n=aa esa=n re? nee?*
 who 3SG=PL=0DET COP=PL REL 3DEM
 ‘Whose (things) are those?’
 b. *hai=nu.*
 1PX=PL
 ‘(They’re) ours.’ elicit. 23/09/18, 1.16 🔊

Two examples of =*ngwein* indexing a plural possessum are given in (93) and (94). This strategy only exists for pronouns which end in a vowel sequence. Two examples of a plural possessum indexed by =*nu*/*n* as well as a determiner are given in (95) and (96).

- (93) *hoo=ngwein na-tuina? =kau,*
hoo=nu=eni na-tuina? =kau
 2SG=PL=PL 3-follow =1SG.ACC
 ‘Yours followed me, ...’ 130914-3, 1.51 🔊
- (94) *?-ak “hei, hoo kartu =sina n-mate=n, bai? Kus,*
?-ak hei hoo kartu =sina n-mate=n, ba?i Kus,
 1SG-say hey 2SG card =ASSOC.PL 3-die=PL grandfather Kus
au=ngwein n-moni=n.
au=nu=eni n-moni=n
 1SG=PL=PL 3-live=PL
 ‘I said: “Your cards have expired, Kus. Mine are valid.’ 130825-6, 7.34 🔊
- (95) *Aba? iin=n=ee =m ees uum ?-ait wanteks.*
Aba? ini=n=ee =ma ees uma ?-aiti wanteks
Aba' 3SG\M=PL=3DET =and COP 1/2SG\come 1SG-take dye
 ‘Aba’s (children), and I were the ones who came and picked up these textile dyes.’ 130914-1, 2.41 🔊
- (96) *mui?t=ein re? ia batuur au=ngw=aa.*
mu?it=eni re? ia true au=nu=aa
animal=PL REL 1DEM true 1SG=PL=0DET
 ‘These animals are really mine.’ Genesis 31:43

6.4.2 Genitive suffixes

Certain nominals in Amarasi take a genitive suffix when they are possessed. These genitive suffixes agree with the person and number of the possessor. They are given in Table 6.12. A fuller discussion of genitive suffixes is given in §A.3.1.

6 Syntactically driven metathesis

Table 6.12: Amarasi genitive suffixes

	SG	PL
1	-k	-m
1,2		-k
2	-m	-m
3	-n	-k
0	-f	

Most nominals which take genitive suffixes are in a part-whole relationship with the possessor. Such nominals are typically body parts. Three examples of possessed “parts” with a genitive suffix are given in (97)–(99) below.

- (97) *esa n-teni?, mnees kiro niim deŋan, faafɔʒ=ee iin eku-n.*
 one 3-again rice kilo five with pig=3DET 3SG neck-3SG.GEN
 ‘The next one, is five kilos of rice with a pig’s neck.’ 130823-5, 0.26 🔊
- (98) *papa, hoo kaan-m=ii sekau, papa?*
 dad 2SG name-1PX/2GEN=1DET who dad
 ‘What is your name, dad?’ 120923-1, 0.01 🔊
- (99) *hoo mu-ʔtuta? au taas=ii n-bi au fuuf-k=ii.*
 2SG 2SG-put 1SG bag=1DET 3-RL.LOC 1SG fontanelle-3PL/1GEN=1DET
 ‘You put my bag above my head.’ 130825-6, 19.04 🔊

In example (99) above there are two possessive constructions; *au taas=ii* ‘my bag’ and *au fuuf-k=ii* ‘my fontanelle’. In the first instance the possessum is not in a part-whole relationship with the possessor and thus does not take any genitive suffix, while in the second instance the possessum a part of the possessor and thus does take a suffix.

Genitive suffixes also occur on possessed property nominals. Three examples are given in (100)–(102) below.

- (100) *nait, iin ma-hiin-n=ii hai m-nao m-ʔurus nai?*
 like.this 3SG PROP-know-3SG.GEN=1DET 1PX 1PX/2-go 1PX/2-arrange Mr.
Robe n-bi neh, mee?
 Robe 3-RL.LOC um where
 ‘Like that, he knew (*lit.* had knowledge) that we were going to arrange Robe at, err, where?’ 130825-6, 11.35 🔊

- (101) *iin mapuut-n=ii kaah=een n-eu hiit be?i na?i =siin.*
 3SG hot-3SG.GEN=1DET NEG=INCEP 3-DAT 1PI PM PF =ASSOC.PL
 ‘He was very cruel (*lit.* hot) to our ancestors.’ Acts 7:19
- (102) *hoo reok-m=ii!*
 2SG good-1PX/2GEN=1DET
 ‘You’re too much!’ (cynical) Genesis 37:10

Another kind of nominal on which genitive suffixes occur are nominalised verbs. Four examples are given in (103) and (104) below which show a number of verbs nominalised with the circumfix *?...?* (§A.2.3). The final element of this circumfix is replaced by the genitive suffix.

- (103) *he mu-skoor m-ain =siin, mu-skoor m-ain siin oke?, hoo*
 IRR 2SG-school 1PX/2-before =3PL 2SG-school 1PX/2-before siin all 2SG
?-mui?-m=ii saa??
 NML-have-1PX/2GEN=1DET what
 ‘If you want to send them to school, send them all to school, (well) what
 (money) do you have?’ 130907-4, 0.36 🔊
- (104) *tangun dʒawab saap iɕa, hita ?-moni-k, hita*
 responsibility because 1DEM 1PI NML-live-3PL/1GEN 1PI
?-hake-k, hita ?-nao-k eta krei =ma
 NML-stand-3PL/1GEN 1PI NML-go-3PL/1GEN IPFV.LOC church =and
prenat.
 government
 ‘Because of this responsibility, it is our life, our standing, our way in the
 Church and government.’ 130825-6, 1.27 🔊

Possessed kin relations also usually take genitive suffixes. Genitive suffixes for kin relations are drawn from a different paradigm than those for other nominals (§A.3.1.1). In the village of Koro'oto, where the bulk of my data was collected, possessed kin relations mostly occur with the suffix *-f*.

6.4.3 Syntax of possession

The possessive phrase forms the specifier of a nominal phrase. The possessive phrase consists of a nominal phrase and an optional possessive pronoun *iin*. Possession does not induce M-forms on either the possessor or the thing possessed. The structure of the possessive phrase is given in (105) below.

6 Syntactically driven metathesis

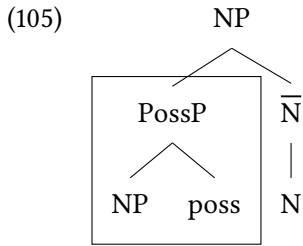

Example (106) below contains a possessive phrase; *Uisneno iin kana-n* ‘God’s name’. This is an example of a full nominal possessor with a possessive pronoun as well a genitive suffix on the thing possessed. The structure of this possessive phrase is given in (107) below.

- (106) *n-boʔis Uisneno iin kana-n.*
 3-praise God\U 3SG name-3SG.GEN
 ‘(They) praised God’s name.’

130902-1, 1.34 🔊

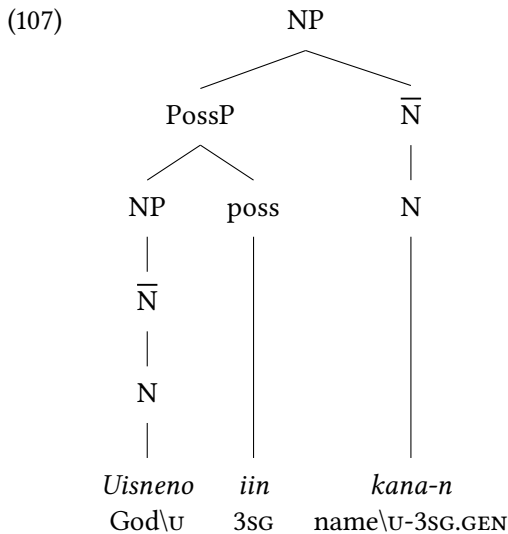

Examples (108)–(110) below show three examples of NP possessors which are not followed by the pronoun *iin*. Nonetheless, the fact that these are possessive phrases is shown clearly by the fact that in each instance the 3SG.GEN suffix *-n* occurs on the thing possessed.

- (108) *na-maikaʔ n-bi Smaraʔ tuna-n.*
 3-settle 3-RL.LOC Smara\U top\U-3SG.GEN

‘He settled on top of Smara’ (name of a headland).’ 120715-4, 0.57 🔊

- (109) *n-nao n-bi taasɔ̄=ee noon-n=ee =ma n-tee Oeneet.*
 3-go 3-RL.LOC sea\̄M=3DET area\̄M-3SG.GEN=3DET =and 3-arrive Oeneet
 ‘He went to the coast as far as Oeneet.’ 130821-1, 4.42 🔊
- (110) *aina? tina-n!*
 mother\U vagina\U-3SG.GEN
 ‘F**k!’ (lit. ‘Mother’s vagina!’) 130825-7, 1.02 🔊

On the surface these phrases consist of two nominals; a structure identical to that of attributive modification. However, due to the different syntactic structure of possession, the first nominal does not occur in the M-form. The structure of the possessive phrase *Smara? tuna-n* ‘top of Smara’ is given in (111) and can be contrasted with that of an attributive nominal phrase, as given in (112) below.

- (111)
- ```

 NP
 / \
 PossP N̄
 | |
 NP N
 | |
 N̄ |
 | |
 N |
 | |
 Smara? tuna-n
 Smara\U top\U-3SG.GEN

```
- (112)
- ```

      NP
      |
      N̄
     /  \
    N̄    N
    |    |
    N    |
    |    |
  faut  muti?
  stlone\M white\U
  
```

As discussed in §6.4.2, only certain nominals in a part-whole relationship with the possessor take genitive suffixes. It is also possible for nominals which do not take genitive suffixes to be possessed by a nominal without an intervening possessive pronoun. Two examples are given in (113) and (114) below, each of which contains two possessive phrases.

6 Syntactically driven metathesis

- (113) *hoo m-rea? atoni? fu- roa-t=aa fua-n =at*
 2SG 1PX/2-grab man\U plant-NML=0DET fruit-3SG.GEN =SUB
berarti naan
 mean 2DEM
 ‘You grabbed the fruit of a person’s plant, that means’ 120923-2, 6.21 🔊

- (114) *Debri, Ornaaḡ=ii, au aanh=ii kabin.*
 Debri Ornai=1DET 1SG child=1DET wedding
 ‘Debri Ornai, my child’s wedding.’ 130825-6, 8.37 🔊

These examples also show that the possessor can be filled by a determiner phrase (§6.5.2). Two additional examples of a determiner phrase as the possessor are given in (115) and (116) below. Each of these examples also have the possessive pronoun *iin*. The structure of the possessive phrase of (116) is given in (117).

- (115) *esa n-teni?, mnees kiro niim deḡan, faafḡ=ee iin eku-n.*
 one 3-again rice kilo five with pig=3DET 3SG neck-3SG.GEN
 ‘The next one, is five kilos of rice with a pig’s neck.’ 130823-5, 0.26 🔊

- (116) *?naef=ii iin uab-n=ii, au ka= ?-nikan =fa!*
 old.man=1DET 3SG speech-3SG.GEN=1DET 1SG NEG= 1SG-forget =NEG
 ‘What the old man said, I haven’t forgotten it!’ 130825-6, 15.28 🔊

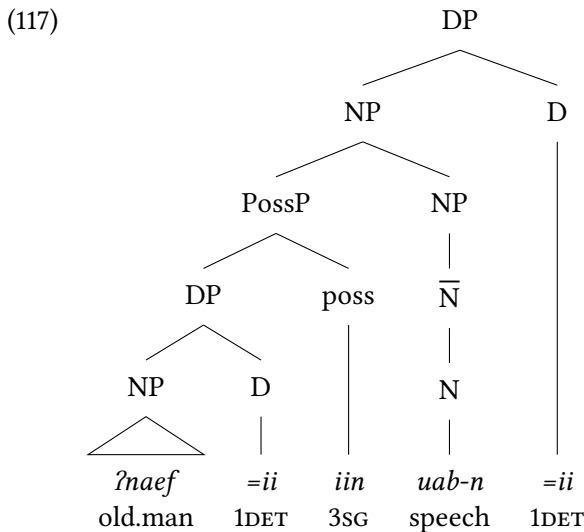

When determiners are the only instantiation of the thing possessed (§6.4.1), the head of the nominal phrase can be analysed as empty. This is consistent with the semantics in which the possessum of such phrases is non-referential and can only be deduced from context. One example is given in (118) below, with the structure of the extended nominal given in (119). (The possessive pronoun is in the M-form due to the following vowel-initial enclitic, see Chapter 5.)

- (118) *bi ehh Esi iindɔ̃=ee msaʔ iin n-tee et Malaysia.*
 bi Esi ini=ee msaʔ ini n-tea et Malaysia
 Ms. Esi 3SG\̄M=3DET also 3SG 3-arrive IPFV.LOC Malaysia
 ‘Esi’s (daughter) has also gone to Malaysia.’ 130909-6, 3.26 🔊

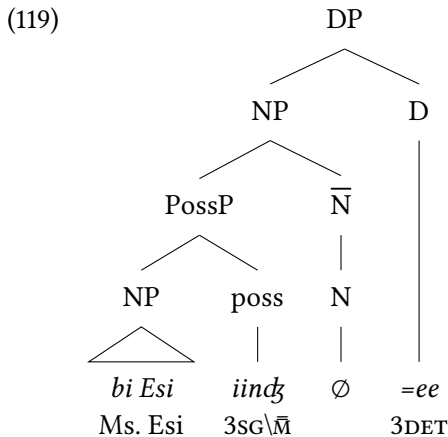

Possession does not induce M-forms on either the possessor or the thing possessed. The evidence from possession shows that only the head of a nominal phrase undergoes metathesis, and that nominal metathesis is only sensitive to the presence of adjuncts and not specifiers.

6.5 Modifiers which are not nominals

In this section I discuss other nominal modifiers which are not themselves nominals. These include numerals (§6.5.1), demonstratives, and determiners (§6.5.2), as well as quantifiers (§6.5.3). Nearly all of these modifiers occur after the (attributive) nominal phrase, and as a result syntactically conditioned M-forms do not usually occur before any of these modifiers. The position of these phrases within the extended nominal is shown in (120) below.

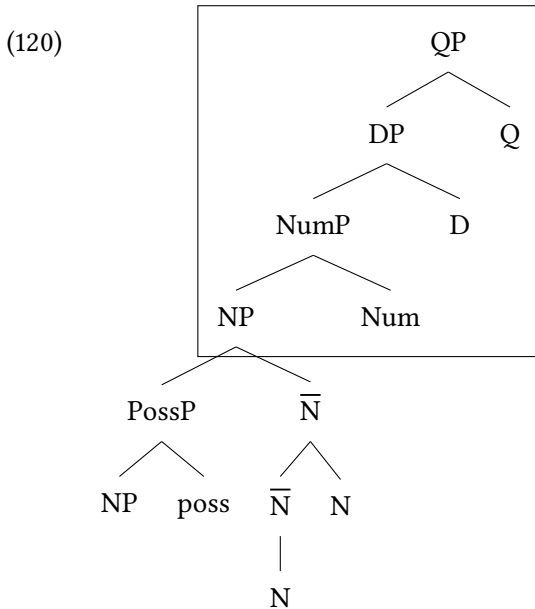

6.5.1 Number phrase

The number phrase occurs immediately after the nominal phrase and before the determiner phrase. The number phrase takes either a cardinal number or number enclitic as its head, and a nominal phrase as its specifier. Cardinal numbers follow the nominal they quantify and this nominal occurs in the U-form. This is straightforwardly explained by positing that numerals are the head of a numeral phrase which is outside the nominal phrase. The basic Amarasi cardinal numbers are given in Table 6.13.

Table 6.13: Amarasi cardinal numerals

no.	Amarasi	gloss	no.	Amarasi	gloss
1	<i>mese?</i>	‘one’	7	<i>hitu/hiut</i>	‘seven’
2	<i>nua</i>	‘two’	8	<i>fanu/faun</i>	‘eight’
3	<i>tenu/teun</i>	‘three’	9	<i>seo</i>	‘nine’
4	<i>haa</i>	‘four’	10	<i>bo?</i>	‘ten’
5	<i>nima/niim</i>	‘five’	100	<i>natun</i>	‘hundred’
6	<i>nee</i>	‘six’	1,000	<i>nifun</i>	‘thousand’

Examples of a cardinal numeral following a nominal are given in (121)–(123). Nominals followed by a cardinal numeral take the U-form. The syntactic structure of the number phrase in (123) is given in (124).

- (121) *ʔ-meup ʔ-aan, nehh, ume, ume boʔ=ees, termasuk hiit ume.*
 ʔ-mepu ʔ-ana ume ume boʔ=esa termasuk hiti ume
 1SG-work 1SG-RES house house\U ten=one including 1PI house
 'I worked on houses, ten houses, including our house.' 130907-3, 3.41 🔊

- (122) *n-fee naan toon teun.*
 n-fee naan toon tenu
 3-give 2DEM year\U three
 'That one has been given three years.' 160326, 15.08 🔊

- (123) *saap n-ak nonoʔ seo, a/n-poi na-raardɔ̄=oo-k =te, oakʔ=een.*
 saap n-ak nonoʔ seo, n-poi na-rari=oo-k =te okeʔ=ena
 since 3-say rod\U nine 3-exit 3-finish=REFL-3PL/1GEN =SUB all=INCEP
 'Since s/he said there were nine rods, when they'd come out, it was done.'
 130906-1, 3.23 🔊

- (124)
-
- ```

 graph TD
 NumP --> NP
 NumP --> Num
 NP --> nonoʔ
 NP --> rod_U[rod\U]
 Num --> seo
 Num --> nine

```

A combination of a nominal and numeral can also occur as the head of a number phrase to indicate measurements. Examples are given in (125)–(128) below. The structure of the number phrase in (128) is shown in (129) below.

- (125) *uma ʔ-tee =ma ʔ-istarika bruuk pasan nima =m,*  
 uma ʔ-tea =ma ʔ-istarika bruuk pasan nima =ma,  
 1/2SG\come 1SG-arrive =and 1SG-iron pants\U set\U five =and  
*u-paan baru pasan nima =m.*  
 u-pana baru pasan nima =ma.  
 1SG-fill shirt\U set\U five =and  
 'I came and ironed five pairs of pants and packed five sets of shirts.'  
 130825-6, 11.21 🔊

6 Syntactically driven metathesis

- (126) *?-ak "ehh, au rookgw=ii ara nono? mese? =t,*  
*?-ak au roko=ii ara nono? mese? =te*  
 1SG-say hey 1SG cigarette=1DET rest\U rod\U one =SUB  
 'I said: I've got one cigarette left.' (*lit* 'one rod rest') 130825-6, 12.54 🔊
- (127) *au u-hana mina? taus mese? mes*  
*au u-hana mina? taus mese?, mes*  
 1SG 1SG-cook oil\U wok one but  
 'I cooked a single wok of oil but ...' 130825-6, 0.44 🔊
- (128) *esa n-teni?, mnees kiro niim denan, faafɔʒ=ee iin eku-n.*  
*esa n-teni? mneas kiro nima denan fafi=ee ini eku-n*  
 one 3-again rice\U kilo\U five with pig=3DET 3SG neck-3SG.GEN  
 'The next one, is five kilos of rice with a pig's neck.' 130823-5, 0.26 🔊

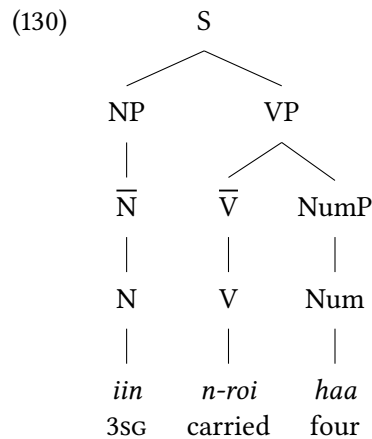
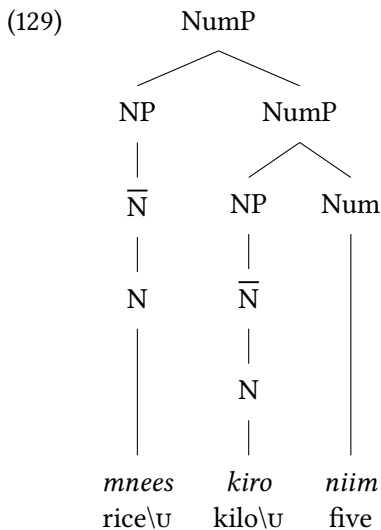

Cardinal numerals can occur independently without any preceding nominal phrase. This provides evidence (apart from the use of U-forms) that numerals are the head of their own phrase. Two numerals as objects of verbs are given in (131) and (132) below. The structure of example (131) is given in (130) above.

- (131) *iin n-roi haa.*  
 3SG 3-carry four  
 'He carried off four.' 130925-1, 3.21 🔊

- (132) *n-reuk fanu =te, pa? Charles, pa? Graims,*  
 3-hit eight =SUB Mr. Charels Mr. Grimes  
*a/n-koen=oo-n neem.*  
 3-depart=REFL-3SG.GEN 3\come  
 ‘As it struck 8:00 Mr. Charles, Mr. Grimes came.’ 130920-1, 0.51 



When a subject pronoun is enumerated, a nominative form of the pronoun occurs before the numeral and an accusative form usually occurs after the numeral. This is the same structure found in pronominal equative clauses (§6.6.1). Two examples are given in (133) and (134) below.

- (133) *hai nua =kai m-mees.*  
 1PX two =1PX.ACC 1PX/2-alone  
 ‘The two of us are alone.’ 130909-6, 3.39 
- (134) *hiit teun =kiit ka= n-eu ta-bee?dɔ̃=ee =fa.*  
 1PI three =1PL.ACC NEG= 3-DAT 1PI-capable=3SG.ACC =NEG  
 ‘The three of us are not going to be able to.’ Mark 16:3-4

### 6.5.1.1 Number enclitics

The head of a number phrase can also be filled by one of the number enclitics =*ein*/*=n* ‘PL’ or =*esa*/*=ees* ‘one’. Evidence that the number enclitics form a separate word class to nominal determiners comes from the fact that they can co-occur with nominal determiners.

Examples of each co-occurring with an enclitic are given in (135) and (136) below. This distribution is straightforwardly explained by positing that the number phrase occurs before the determiner phrase and that the number enclitics are the head of the former.

- (135) *siin uup?=ein=ee, hoo m-ok fauk et umi?*  
 3PL CC=PL=3DET 2SG 1PX/2-with how.many IPFV.LOC house  
 ‘Those grandkids, how many are at home with you?’ 130909-6, 3.16 
- (136) *?-fei kraan=ees=ii =ma ?-toro?, ohh.*  
 1SG-open tap=one=1DET =and 1SG-catch.liquid  
 ‘I turned on one of the taps and tested, ohh.’ 130825-8, 1.41 

It is possible for the enclitic =*ein* to co-occur with a numeral. When it does, the numeral must take the ordinal form, despite having no ordinal meaning. It thus

6 Syntactically driven metathesis

occurs as an attributive modifier within the noun phrase (§6.3.5). Two examples are given in (137) and (138) below, with the structure of (138) given in (139).

- (137) *lantas, na-ʔko reʔ tua haaʔ=ein reʔ ia,*  
*lantas na-ʔko reʔ tua-f haa-ʔ=eni reʔ ia*  
 forthwith 3-ABL TOP person\M four-ORD=PL REL 1DEM  
*siin na-honi n-teinʔ=ein =ama,*  
*sini na-honi n-teniʔ=eni =ma*  
 3PL 3-birth 3-again=PL =and

‘Then from these four people, they gave birth again.’ 130821-1, 7.38 ◀▶

- (138) *ahh, kua hiut-ʔ=ein naan, au ʔ-tea ʔ-rair.*  
*kuan hitu-ʔ=eni naan au ʔ-tea ʔ-rari*  
 village\M seven-ORD=PL 2DEM 1SG 1SG-up.to 1SG-finish

‘Ah yes, those seven villages, I’ve already been to.’ elicit. 15/03/16  
 41.50 ◀▶

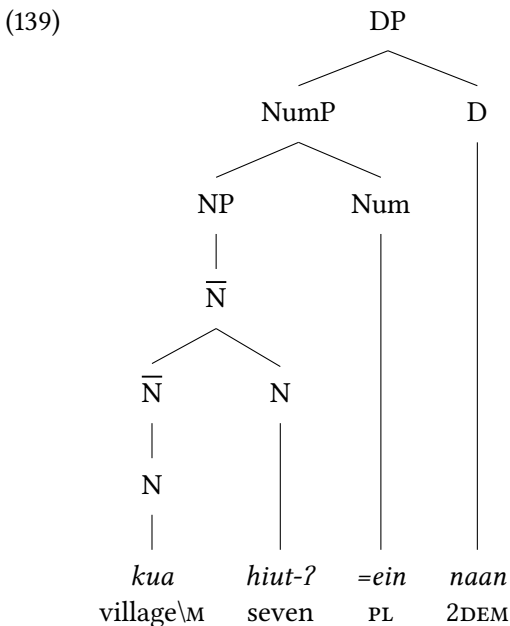

To summarise, nouns take the U-form before cardinal numerals as numerals are the head of their own phrase which is outside the nominal phrase. When the head of the numeral phrase is occupied by a number enclitic, any numeral is forced to take its ordinal form and occurs within the nominal phrase, thus inducing metathesis on the head nominal.



## 6.5.2 Determiner phrase

The head of the determiner phrase in Amarasi is filled by either a demonstrative or a determiner. Syntactically conditioned M-forms do not occur before the determiner phrase. The determiner phrase occurs after the number phrase and before the quantifier phrase. The Amarasi demonstratives and determiners are given in Table 6.14 below. They have the same four person values present in the genitive suffixes (§A.3.1, §6.4.2). Demonstratives and determiners do not co-occur.

Table 6.14: Amarasi demonstratives and determiners

| Pers. | DEM                         | DET               | Function                                      |
|-------|-----------------------------|-------------------|-----------------------------------------------|
| 1     | <i>ia, iɟa</i> <sup>†</sup> | = <i>ii</i>       | “near” speaker                                |
| 2     | <i>nana/naan</i>            | = <i>ana/=aan</i> | “near” addressee                              |
| 3     | <i>nee</i>                  | = <i>ee</i>       | “near” third person                           |
| 0     | <i>naa</i>                  | = <i>a</i>        | location “near” no-one ( $\approx$ obviative) |

<sup>†</sup> The 1DEM form *iɟa* is rare with only twelve attestations in my corpus compared with 267 of *ia*. It occurs mainly in the speech of older speakers.

Nouns preceding demonstratives occur in the U-form. Demonstratives have two main functions. Firstly, they can be used to introduce new participants into the discourse, as shown in (140) below. Secondly, they are used when the spatial, temporal, or referential location of the previous nominal is in focus. This is shown in (141) and (142) below. The structure of the determiner phrase in (142) is given in (143) below.

- (140) *nenō naa paha\_?pina-n ia, a|n-kobub on bare mese?*  
 nenō naa paha\_?pina-n ia, n-kobub on bare mese?  
 day\U 0DEM land\_below\U-3SG.GEN 1DEM 3-pile IRR.LOC place one

‘In those days this world was piled up in one place.’ 120715-4, 0.05 🔊

- (141) *nehh, baab Sara? n-nao et pani-n nee.*  
 baba Sara? n-nao et pani-n nee  
 MB/FZ Sarah 3-go IPFV.LOC across\U-3SG.GEN 3DEM

Well, Aunt Sarah had gone across there.’ 130906-1, 2.48 🔊

6 Syntactically driven metathesis

- (142) *of papa? naan na-papa? terus.*  
of papa? naan na-papa? terus  
sure wound\U 2DEM 3-wound constant  
‘That wound will surely be a wound constantly.’ 120923-2, 5.03 🔊

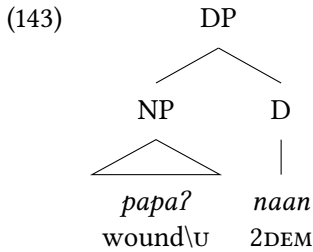

Nominals occur in the U-form before demonstratives because the latter are the head of their own phrase and do not occur inside the nominal phrase. Independent evidence for this analysis comes from the fact that demonstratives frequently occur with no preceding nominal. This behaviour is very common in my corpus, with most demonstratives not following a nominal phrase.

Depending on the discourse pragmatics and syntactic structures of the entire sentence, an independent demonstrative is interpreted as a locational adjunct, as in (144) below, or as a verbal object, as seen in (145)–(147) below. The structure of the first part of example (147b) is given in (148) below.

- (144) *ahirpa ahh, n-aim naan baardɔ̄=esa =m na-maika? n-*  
in.the.end 3-look.for 2DEM place=one =and 3-settle  
‘In the end, he looked there for a place and settled.’ 120715-4, 0.55 🔊
- (145) *hai ima m-tea ia, eh, n-reuk hitu n-kono kre?o.*  
1PX 1PX/2PL\come 1PX/2-arrive 1DEM 3-hit seven 3-past little  
‘We arrived here a little bit after it struck 7:00.’ 130920-1, 0.45 🔊
- (146) *iin na-maika? n-bi nee, a/n-sao nte- a/n-sao n-bi nee.*  
3SG 3-settle\U 3-RL.LOC 3DEM 3-marry 3-marry 3-RL.LOC 3DEM  
‘He settled there and married again-, married there.’ 130821-1, 4.52 🔊
- (147) a. *siin ka= na-hini=n =fa n-eu hoo m-nao on Jakarta.*  
3PL NEG= 3-know=PL =NEG 3-DAT 2SG 1PX/2-go IRR.LOC Jakarta  
‘They didn’t know you were going to Jakarta.’ 130825-6, 12.10 🔊
- b. *hoo m-?ain naa, oo? hoo m-?ain =siin.*  
2SG 1PX/2-head.to\M 0DEM Q 2SG 1PX/2-head.to\M =3PL  
‘You were heading there, no? You were heading towards them.’ 12.13

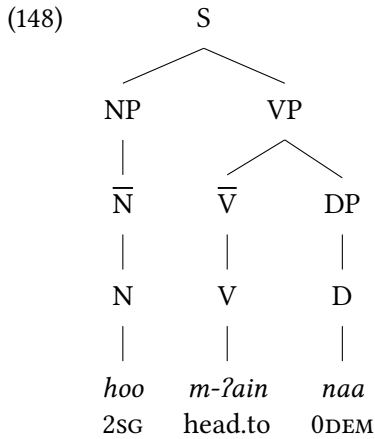

Nouns take the U-form before demonstratives because demonstratives are the head of a determiner phrase, which in turn contains the nominal phrase. Demonstratives are outside the nominal phrase and outside the domain of metathesis.

### 6.5.3 Quantifier phrase

Amarasi has two kinds of quantifiers: those which occur before the nominal phrase and those which occur after the nominal phrase. The post-nominal quantifiers are *okeʔ* ‘all’ and *fauk* ‘several, how many?’. The pre-nominal quantifiers are *baʔuk* ‘many, how many?’ and *areʔ* ‘every’. None of these quantifiers trigger M-forms.<sup>13</sup>

#### 6.5.3.1 Post-nominal quantifiers

Examples of post nominal *fauk* ‘several’ and *okeʔ* ‘all’ or their reduplicated variants are given in (149)–(152) below. The reduplicated variants of these quantifiers are extremely common.

- (149) a. *onai =m hai mi-rair surat fak~fauk=een aiʔ nai-*  
 and.so 1PX 1PX/2PL-finish paper\U INTNS~several=INCEP OR  
 ‘So we’ve now finished several books, or’ 130920-1, 4.53 🔊
- b. *ʔnakaʔ fak~fauk=een.*  
 chapter\U INTNS~several=INCEP  
 ‘several chapters’ 4.56

<sup>13</sup>Despite its semantics *mfaun* ‘many, much’ is a nominal and triggers M-forms as expected when used attributively.

6 Syntactically driven metathesis

- (150) *oras hai m-took m-ok siin of neno fauk =ate,*  
time 1PX 1PX/2-sit\M 1PX/2-with 3PL later day\U several =SUB  
‘When we had stayed with them for several days,’ Acts 21:10
- (151) *bi Ripka na-honi? ri?aan koen. mone=n oke?.*  
Ms. Rebecca 3-birth child twin male\U=PL all  
‘Rebecca gave birth to twins. (They were) both male.’ Genesis 25:24
- (152) *mi-sanut mui?t=ein naan ok~oke?!*  
1PX/2PL-go.down animal=PL 2DEM INTNS~all  
‘Put all those animals down.’ Genesis 8:17

Most instances of *oke?* in my corpus are of the phrase *oke? =te* ‘all =SUB’ which has the conventionalised meaning ‘after that’. The form *oke?* also frequently occurs as an adverbial with the meaning ‘completely, finished’.

Neither of these quantifiers can float, instead they must follow the nominal phrase they modify. This is shown in (153) below, in which the phrase-final quantifier in (153b) and pre-nominal quantifier in (153c) are both ungrammatical.

- (153) a. *au ?-tea ?-rair kuan fak~fauk=een.*  
*au ?-tea ?-rari kuan fak~fauk=ena*  
1SG 1SG-arrive 1SG-finish village\U INTNS~several=INCEP
- b. \* *au ?-tea ?-rair fak~fauk kuan=een*  
1SG 1SG-arrive 1SG-finish INTNS~several village=INCEP
- c. \* *au ?-tea ?-rair kuan=een fak~fauk*  
1SG 1SG-arrive 1SG-finish village=INCEP INTNS~several  
‘I’ve already been to several villages.’ elicitation 15/03/16 p.47

These post nominal modifiers rarely modify a nominal phrase already modified by a demonstrative or determiner. When they do, they occur after the demonstrative or determiner. Two examples are given in (154) and (155) below.

- (154) *rari =t hai mi-srain ain Lidia n-ok iin uumɟ=ee*  
finish =SUB 1PX 1PX/2PL-baptize mother Lidia 3-with 3SG house=3DEP  
*naan-n=ee oke?.*  
inside-3SG.GEN-3DET all  
‘Then we baptised Lidia with all her household.’ Acts 16:15
- (155) *neengw=ees=ii, au ?-toup u-rair hii roit=ein naan oke?.*  
day=one=1DET 1SG 1SG-receive 1SG-finish 2PL money=PL 2DEM all  
‘That day I received all that money of yours.’ Genesis 43:23

The extended nominal in example (155) above attests every possible nominal modifier with the exception of an attributive nominal. Its structure is given in (156) below.

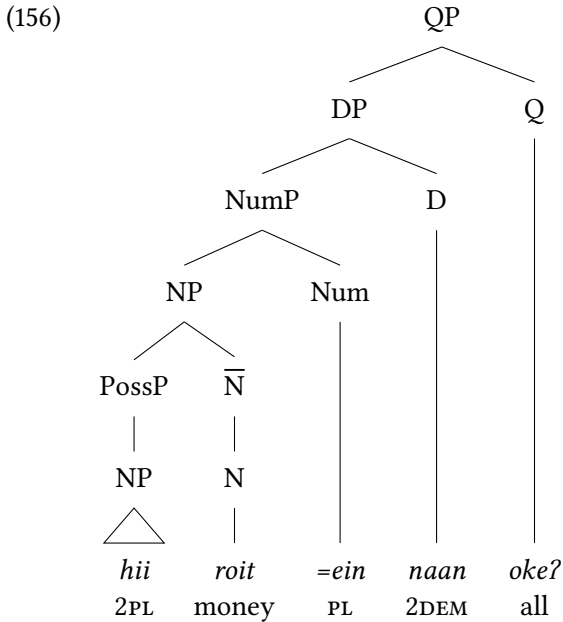

As with numerals and demonstratives, quantifiers can occur independent of a nominal phrase. Two examples of *fauk* are given in (157) and (158). Similarly, two examples of independent *oke?* are given in (159) and (160), though in these examples *oke?* could be being used adverbially to mean ‘completely’.

- (157) *of\_oni? n-poir?=ee n-ak =am, "hoo m-eik fauk ia."*  
 maybe 3-throw=3SG.ACC 3-say =and 2SG 1PX/2-bring several 1DEM  
 ‘Maybe he got rid of it saying: Take some of these.’ 130925-1, 3.47 🔊
- (158) *toon=ees=ii, hoo m-seik fauk?*  
 year=one=1DET 2SG 1PX/2-harvest.corn how.many  
 ‘How much corn did you harvest last year?’ 130909-6, 0.52 🔊
- (159) *m-ak, hai nua =kai m-taikobi =m hai m-maet oke?*  
 1PX/2-say 1PX two =1PX.ACC 1PX/2-fall =and 1PX 1PX/2-die all  
 ‘So the two of us fell and we both/completely died.’ 130909-6, 0.39 🔊

6 Syntactically driven metathesis

- (160) *are?* *paah=ii*      *n-he?e=n*    =*kau oke?*    =*m, hii ka=*  
 every country=1DET 3-deride=PL =and =1SG.ACC all 2PL NEG=  
*mi-hine*            =*f.*  
 1PX/2PL-know =NEG

‘The whole world derided me. / completely derided me. You don’t know (how it was).’  
 130825-6, 0.08 🔊

In example (157) the quantifier *fauk* occurs before the demonstrative *ia*. In this instance the quantifier is the head of a nominal phrase. There is one other example of a quantifier within a nominal phrase in my data, this example is given in (161) below, in which the quantifier occurs as an attributive modifier with the head nominal taking the M-form as expected.

- (161) *nean fauk=ii*            *na-?uur ?*  
*nenō fauk=ii*            *na-?ura*  
 day\M how.many=1DET 3-rain

‘Which day did it rain?’  
 130909-6, 1.26 🔊

In (161) the quantifier is an attributive modifier “replacing” the ordinal numeral which would occur here as the name of a day (§6.3.5). The phrase *nean fauk* ‘which day’ in (161) can be compared with the phrase *nenō fauk* ‘several/how many days’ in examples such as (150). Syntactic trees showing the structure of each of these phrases are given in (162) and (163) respectively.

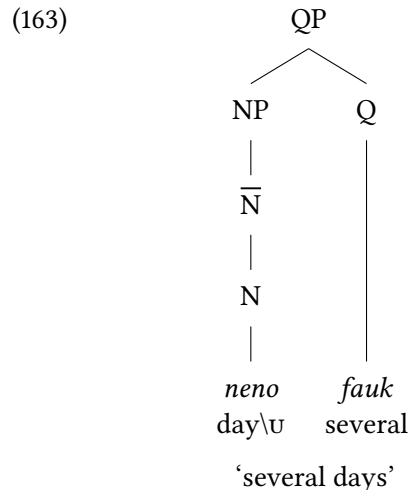
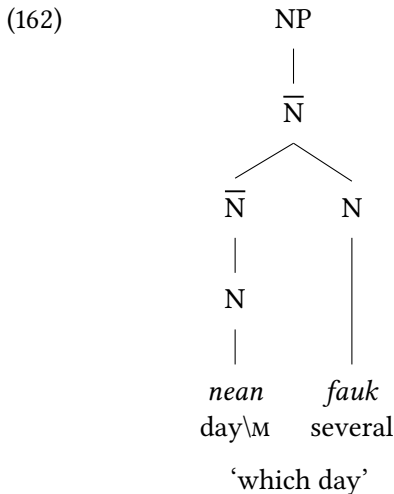

## 6.5.3.2 Pre-nominal quantifiers

The quantifiers *baʔuk* ‘many, how many?’ and *areʔ* ‘all, every’ occur before the nominal phrase. Post-nominal *okeʔ* ‘all’ focusses on the quantified unit as a complete whole, while *areʔ* focusses on the quantified unit as a collection of individuals. Examples of *baʔuk* ‘many, how many?’ and *areʔ* ‘all, every’ are given in (164)–(166). The structure of the quantified nominal in (166) is given in (167).

- (164) *aina! iin na-sae-b baʔ~baʔuk atoinʔ=einʔ*  
 mother 3SG 3-rise-TR INTNS~how.many man=PL  
 ‘Oh my! How many people was it carrying?’ 130911-2, 0.59 🔊
- (165) *nema =t, na-ha n-rair areʔ mnaahʔ=ii =m ka= na-ʔoi*  
 3\come =SUB 3-eat 3-finish every food=1DET =and NEG= 3-leave  
 ‘(They) came and ate all the food and didn’t leave.’ 130906-1, 5.19 🔊
- (166) *hai mi-rari =te, hai m-, m-fee mainuan n-eu*  
 1PX 1PX/2PL-finish =SUB 1PX 1PX/2-give opportunity 3-DAT  
*a-naʔapreent =ama, areʔ saksii, mahonit he n-fee, ahh, faineka-t*  
 NML-official =and every witness clan.elder IRR 3-give advise-NML  
 ‘We gave an opportunity to the government officials and all the witnesses,  
 the clan elders to give advice.’ 130902-1, 0.51 🔊

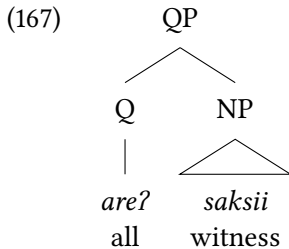

The quantifier *areʔ* ‘every’ can co-occur with *okeʔ* ‘all’. Two examples from the Amarasi Bible translation are given in (168) and (169) below.

- (168) *batuur, areʔ tuaf=ein ok~okeʔ reʔ ina n-toup =sina n-ʔʒari=n*  
 true every person=PL INTNS~all REL 3SG 3-receive =3PL 3-become=PL  
*iin aanh=ein,*  
 3SG child=PL  
 ‘Every person whom He accepts becomes His children.’ Hebrews 12:6

6 Syntactically driven metathesis

- (169) *rari =t are? a-maet-s=ein ok~oke?, siin ar=siin nema=n*  
 finish =SUB every NML-die-NML=PL INTNS~all 3PL all=3PL 3\come=PL  
 =*ma n-baiseun ?-toko prenatal naan.*  
 =and 3-look.up NML-sit govern 2DEM  
 ‘Then all the dead people came and stood before that governing seat (i.e. throne).’  
 Revelation 20:13

When a pronoun is quantified, the usual strategy is for *ar=* ‘all’ to precede the accusative form of the pronoun. This *ar=* is a phonologically reduced form of *are?*. Examples are given in (170)–(173) below. Such quantified pronouns are also usually preceded by an agreeing pronoun, as in (170)–(172), but this preceding pronoun is optional, as seen in (173).

- (170) *karu hii ar=kii, m-naa? liturgi =te*  
 if 2PL all=2PL.ACC 1PX/2-hold liturgy =SUB  
 ‘If you’re all holding a liturgy,’ 130821-1, 1.40 🔊
- (171) *hiit ar=kiit ta-hini t-toom.*  
 1PI all=1PI.ACC 1PI-know 1PI-clear  
 ‘We all know (that) clearly.’ 130821-1, 7.13 🔊
- (172) *itu jaŋ kemudian he- au he u-reet?=ee*  
 that REL then 1SG IRR 1SG-story=3SG.ACC  
*n-eu =kiit ar=kiit.*  
 3-DAT =1PI.ACC all=1PI.ACC  
 ‘That is what I want to tell us all,’ 130821-1, 2.46 🔊
- (173) *ar=kita t-tae liturgi, ar=kita t-sii, au u-skau*  
 all1PI.ACC 1PI-look.down liturgy all=1PI.ACC 1PI-sing 1SG 1SG-invite  
*ar=kiit t-fena t-haek.*  
 all=1PI.ACC 1PI-rise 1PI-stand  
 ‘We’ll all look at the liturgy, we’ll all sing, I invite us all to stand.’ 130821-1, 9.56 🔊

I also have one example of this *ar=* attached to a relativiser and one example of it attached to a numeral. For the sake of completeness these two examples are given in (174) and (175) below.



- (174) *?-ait ne? neh persiapan lenkap eh ar=ne? tempat duduk.*  
 1SG-take REL preparations complete all=TOP place sit  
 ‘I took that thing, umm, the preparations were complete, all those places to seat.’ 130825-8, 0.23 🔊
- (175) *oke, of ar=nua saa?, ai? kaah?*  
 OK maybe all=two thing or NEG  
 ‘OK, maybe both those things (stories), right?’ 120715-4, 2.59 🔊

In summary, quantifiers do not induce M-forms on the nominal as they form the head of their own quantifier phrase. This quantifier phrase is outside of the nominal phrase, and can occur either before or after the nominal phrase.

## 6.6 Equative clauses

An equative clause involves two adjacent nominal phrases which have the same referent. One nominal functions as the subject and the other as a non-verbal predicate. Given examples such that in (176) below, which has been cited several times in this book, we do not expect M-forms to occur on either member of an equative clause. This is indeed the case.



- (176) [NP *fatu* ] [NP *ko?u* ]  
 stone\U big\U  
 ‘Stones are big.’

While sentence (176) is judged acceptable by native speakers, equative clauses in which both halves consist of only a single nominal phrase are extremely rare in natural data. It is much more usual for one half of the equative clause to be a determiner phrase. Two textual examples of an equative clause are given in (177) and (178) below. In each of these examples the first part of the equative clause is a determiner phrase (§6.5.2) and the second part is a nominal phrase.

- (177) [ *?naka skoor=ii* ]<sub>i</sub> [ *bifee.* ]<sub>i</sub>  
 head school=1DET woman  
 ‘The headmaster was a woman.’ 130907-3, 0.33 🔊
- (178) [ *meens=ii* ]<sub>i</sub> [ *huma? mes-mese?* ]<sub>i</sub> *ka= n-beda =fa*  
 sickness=1DET kind INTNS~one NEG= 3-different =NEG  
 ‘The sickness was exactly the same (*lit.* one kind). It wasn’t different.’  
 120923-1, 12.49 🔊

## 6 Syntactically driven metathesis

Two similar examples are given in (179) and (180) below. In each of these examples the second part of the equative phrase consists of a property nominal.

- (179) [ *taaʔɕʒ=ees=ii* ]<sub>i</sub> [ *mutiʔ.* ]<sub>i</sub>  
 branch=one=1DET white  
 ‘One of these branches was white.’ 130823-2, 0.49 
- (180) *mama*, [ *au huutgw=ii* ]<sub>i</sub> [ *maʔtaneʔ.* ]<sub>i</sub> *aaʔ*?  
 mum 1SG louse=1DET strong Q  
 ‘I’ve got lots of lice, haven’t I?’ (*lit.* my lice are strong) 130914-3, 1.03  

### 6.6.1 Pronominal equative clauses

When the first part of an equative clause is a third person pronoun, the nominal phrase simply follows the pronoun. Two examples are given in (181) and (182) below with a thing nominal and property nominal respectively. Pronominal equative clauses do not induce M-forms on either member of the equative clause. Example (181) is a left-dislocated topic, with the referential information outside the clause proper, and the trace pronoun being the syntactic subject of the equative clause.

- (181) *Mooʔhituʔ reʔ naan*, [ *iin* ]<sub>i</sub> *ahh* [ *kaunaʔ.* ]<sub>i</sub>  
 Mooʔhituʔ REL 2DEM 3SG snake\U  
 ‘Now as for that Mooʔ-Hitu, he was a snake.’ 120715-4, 1.16 <sup>14</sup>
- (182) *aʔnaef=ee et reʔ nee.* [ *iin* ]<sub>i</sub> [ *reko.* ]<sub>i</sub>  
 old.man=3DET IPFV.LOC TOP 3DEM 3SG good\U  
 ‘The old man is there. He is well.’ Genesis 29:6

When the pronoun in an equative clause is not third person singular, the nominal phrase is preceded by a nominative pronoun and usually followed by an accusative pronoun. Four examples are given in (183)–(186) below.

- (183) [ *hoo* ]<sub>i</sub> [ *a-baka-t* ]<sub>i</sub> [ *=koo.* ]<sub>i</sub> *m-ak mu-baka =ma*  
 2SG NML-steal\U-NML =2SG.ACC 1PX/2-say 2SG-steal =and  
*m-tama =te*  
 1PX/2-go.in =SUB  
 ‘You are a thief, meaning when you steal and enter.’ 120923-2, 1.51 

<sup>14</sup>In the accompanying audio file for (181) another speaker first completes the equative clause for the main narrator with the word *kaunaʔ* ‘snake’, before the narrator completes it himself.

- (184) *au u-toon, au au au* [ *au* ]<sub>i</sub> [ *a-mon~mono-t* ]<sub>i</sub> [ *=kau!* ]<sub>i</sub>  
 1SG 1SG-tell 1SG NML-INTNS~stupid\U-NML 1SG.ACC  
 ‘I tell (you), I was a real idiot!’ 130825-6, 3.12 🔊
- (185) *n-ak hei =te, [ hoo ]<sub>i</sub> [ mun~munif ]<sub>i</sub> [ =koo ]<sub>i</sub> =t, mu-snaas*  
 3-say hey =SUB 2SG INTNS-young\U =2SG.ACC =SUB 2SG-stop  
*mu-?ko...*  
 2SG-ABL  
 ‘Saying: Now, while you’re young, you should stop.’ 130907-3, 4.52 🔊
- (186) *hii ro he kninu?, na-tuin [ au ]<sub>i</sub> [ kninu? ]<sub>i</sub> [ =kau. ]<sub>i</sub>*  
 2PL must IRR clean 3-because 1SG clean =1SG.ACC  
 ‘You must be holy because I am holy.’ 1 Peter 1:16

Equative clauses do not trigger M-forms on either nominal because neither nominal is syntactically modifying the other within the nominal phrase. The only phonological difference between an equative clause and an attributive phrase is that the first nominal in an equative clause is in the U-form while the first nominal in an attributive phrase is in the M-form. The comparison of equative clauses with attributive phrases provides strong evidence of the morphological nature of Amarasi metathesis.

## 6.7 Serial verb constructions

Syntactically conditioned M-forms also occur in the verb phrase to mark a serial verb construction (SVC). Formal properties which allow us to identify a word class of verbs were given in Table 6.1 above, repeated as 6.15 below. The clearest of these formal properties is that verbs obligatorily agree with the person and number of the subject (except in some imperatives) by taking a verbal agreement prefix.<sup>15</sup> The form and distribution of these prefixes is discussed in §A.1.1.<sup>16</sup>

“A serial verb construction (SVC) is a sequence of verbs which act together as a single predicate” (Aikhenvald 2006: 1). Non-initial verbs in an Amarasi SVC occur in the M-form. The analysis I adopt is one in which members of an SVC

<sup>15</sup>There are only four verbs in my corpus which do not agree with the subject of the sentence. These are the auxiliaries *he* IRR ‘irrealis’, and *bisa* ‘can’ (from Malay *bisa*), as well as the locational verbs *on* IRR.LOC ‘irrealis locative’ and *et* IPFV.LOC ‘imperfective locative’. Other locational verbs including *n-bi* RL.LOC ‘realis locative’ and *na-?ko* ‘ABL, ablative’ all take agreement prefixes as expected.

<sup>16</sup>The verb  $\sqrt{Vma}$  ‘come’ has an irregular conjugation. See Table A.3a on page 441 for details.

6 Syntactically driven metathesis

Table 6.15: Amarasí word classes<sup>†</sup>

|               | agr- | NML | TR | RECP | C#→∅ | SUBJ/OBJ | =Det | =Num |
|---------------|------|-----|----|------|------|----------|------|------|
| Nominal       | -    | -   | -  | -    | ✓    | ✓        | ✓    | ✓    |
| Precategorial | ✓    | ✓   | ✓  | ✓    | ✓    | ✓        | ✓    | ✓    |
| Verb          | ✓    | ✓   | ✓  | ✓    | -    | -        | -    | -    |

<sup>†</sup> agr-: take verbal agreement prefixes (§A.1.1), NML can be nominalised with the circumfix *a...-t* (§A.2.1), TR can take the transitive suffix *-b* (§A.3.2), RECP can take the reciprocal prefix *ma(k)-* (§A.1.2), C#→∅ final consonant can be deleted to derive verbs (§6.2.1), SUBJ/OBJ can be the subject or object of a verb, =Det can take definiteness marking determiners (§6.2.3), =Num can take number enclitics (§6.5.1.1).

are adjuncts below the level of  $\bar{V}$ , in the same way as attributive modifiers are adjuncts below the level of  $\bar{N}$ . The proposed structure of the Amarasí verb phrase is given in (187) below. The object nominal phrase fills the specifier position.

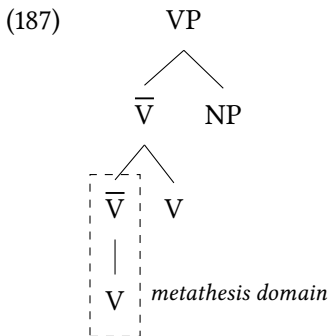

Having the object nominal appear in the specifier position of the VP in (187) is cross-linguistically unusual. The reason it occurs in this position rather than a complement position, close to the head verb, as is commonly the case in other languages, results from its competition with the attributive adjunct in relation to the structural domain of metathesis marking dependency in Amarasí. Unlike attributive verbs, object nominals do not induce M-forms on the verb, and verbs with an object freely occur in the U-form or M-form as determined by the discourse structures of the entire phrase, as discussed in Chapter 7.

Three examples of SVCs in Amarasí are given in (188)–(190) below. The final verb of an SVC occurs in the U-form or M-form depending on the discourse structures of the clause (Chapter 7). The structure of the verbal clause of example (190) is given in (191) below.

- (188) *ahh kaah, neno kreeç=i* =te, *hai m-taam* *mi-krei*.  
 kaah neno krei=i =te hai m-tama mi-krei  
 NEG day church=1DET =SUB 1PX 1PX/2-enter\M 1PX/2PL-church  
 ‘Ah no, when it was Sunday, we went to church.’ 130902-1, 2.09 🔊
- (189) *saap au ?-soi?* *u-rair*.  
 saap au ?-so?i u-rari  
 because 1SG 1SG-count\M 1SG-finish\M  
 ‘Because I’d finished counting.’ 130825-6, 0.36 🔊
- (190) *tuaf=esa n-fain neem, kaan-n=ee nai? Tu?as*.  
 tuaf=esa n-fani nema kana-n=ee nai? Tu?as  
 person=one 3-return\M 3\come\M name-3SG.GEN=3DET Mr. Tu’as  
 ‘One person came back (here), his name was Tu’as.’ 130821-1, 5.00 🔊

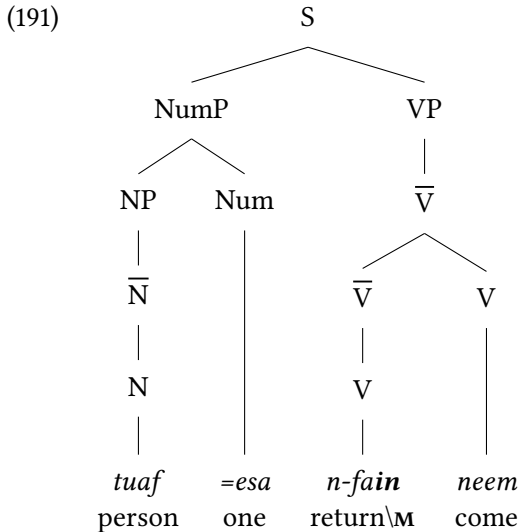

In a cross-linguistic survey of SVCs Aikhenvald (2006) gives five properties of canonical SVCs. Of these, Amarasí SVCs clearly conform to at least four, listed in (192) below.

- (192) Properties of serial verb constructions in Amarasí:
- Single predicate (SVCs function on par with monoverbal clauses)
  - Single intonation (intonation is the same as monoverbal clauses)
  - Single tense/aspect/mood/polarity
  - encode a single event

## 6 Syntactically driven metathesis

The only property of an SVC given by Aikhenvald (2006) to which Amarasi SVCs arguably do not conform is that SVCs should be “monoclausal and allow no markers of syntactic dependency on their components” Aikhenvald (2006: 6). In Amarasi non-final verbs of an SVC occur in the M-form, which I analyse as a marker of syntactic dependency; M-forms are a construct form (§2.6.1) which mark the presence of a dependent modifier.

Aikhenvald (2006) includes this criterion in her definition to distinguish SVCs from other structures including “coordination, consecutivization, complement clauses [and] subordinate clauses”. In Amarasi each of these kinds of clauses have different structures. The differences between an SVC, coordination, and complement clauses are illustrated with an example each in (193)–(195) below.

Example (193) is an instance of an SVC. The two verbs are immediately adjacent and the first is in the M-form. Example (194) is an instance of coordination or consecutivization and the connector *=ma* occurs between the two verbs. (See §7.6 for more discussion of the structure of coordination.) Example (195) is an instance of complementization or subordination, and the subordinate clause is introduced with the irrealis verb *he*.

### (193) Serial verb construction

*au ka= ?-aim u-hiin =fa roit.*  
*au ka= ?-ami u-hini =fa roit*  
 1SG NEG= 1SG-look.for\M 1SG-know\M =NEG money  
 ‘I don’t know how to look for money.’ 130825-6, 0.52 🔊

### (194) coordination/consecutivization

*?-aiti =ma ?-rees=een.*  
*?-aiti =ma ?-resa=ena*  
 1SG-pick.up\U =and 1SG-read\M=INCEP  
 ‘(I) picked (them) up and started to read.’ 130825-6, 21.14 🔊

### (195) complement/subordinate clause

*?-aim he ?-soos bantal.*  
*?-ami he ?-sosa bantal*  
 ?-look.for\M IRR 1SG-buy\M cushion  
 ‘I’m looking to buy a cushion.’ 130914-1, 1.01 🔊

SVCs with more than two verbs also occur. All non-final verbs in such SVCs occur in the M-form, and the final verb in the U-form or M-form as determined by the discourse (Chapter 7). Two examples are given in (196) and (197) below,

though only in (197) does each of the non-final verbs have a distinct M-form. The structure of (197) is given in (198) below.

- (196) *ʔ-ak*: “*au ʔ-nao ʔ-meo ʔ-aan bi Uli n-ok bi Rahel*”.  
*ʔ-ak au ʔ-nao ʔ-meo ʔ-ana bi Uli n-oka bi Rahel*  
 1SG-say 1SG 1SG-go 1SG-see 1SG-RES\M Ms. Uli 3-with\M Ms. Rachel  
 ‘I said: “I’ll go and see Uli and Rachel.”’ 130825-6, 16.55 🔊

- (197) *n-ak* “*au ʔ-oat ʔ-iis ʔ-aan*”.  
*n-ak au ʔ-ote ʔ-isa ʔ-ana*  
 3-say 1SG 1SG-cut\M 1SG-completely\M 1SG-RES\M  
 he said: “I’ll cut (him) dead.”’ 130925-1, 1.30 🔊

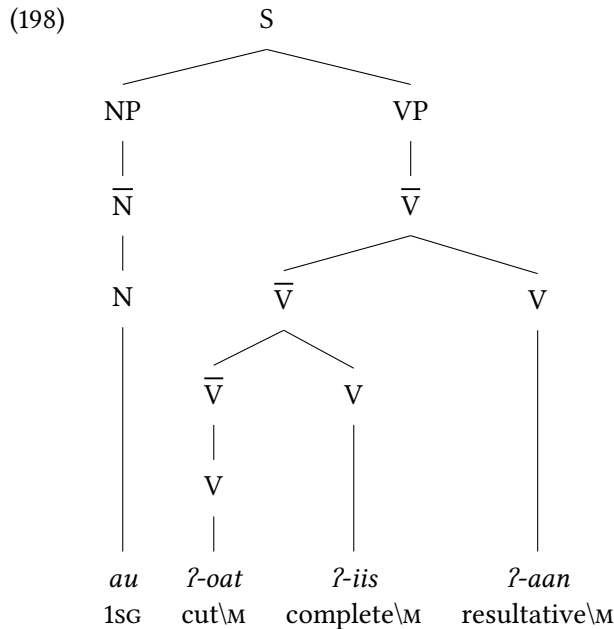

There are a number of verbs which occur frequently or exclusively in SVCs. The discussion in this section draws upon that of Jacob & Grimes (2011), who analyse SVCs in Kupang Malay. The similarities between Kupang Malay and Amarasu SVCs are a result of Kupang Malay calquing on structures found in the local languages of western Timor.

The root *ʔani* occurs almost exclusively as the final verb of an SVC. It carries a temporal meaning, indicating that the event encoded by the SVC occurs before some other event. Occasionally it also means ‘directly, straight-away’. An exam-

ple with the meaning ‘before’ is given in (199) below, and an example with the meaning ‘directly, straight-away’ in (200).

- (199) *iin n-toko =t, iin ofa n-reis n-ain are? haef=ein a/msa?.*  
 ini n-toko =te ini ofa n-resi n-ani are? haef=eni msa?  
 3SG 3-sit =SUB 3SG sure 3-plan\M 3-before each messenger=PL even  
 ‘While sitting he’ll surely even plan the messengers beforehand.’ 130913-1,  
 2.43 🔊

- (200) *ma hai mi-soup m-ain =siin ees re? neno nana msa?.*  
 ma hai mi-sopu m-ani =sini esa re? neno nana msa?  
 and 1PX 1PX/2PL-finish\M 1PX/2-direct\M =3PL COP REL day 2DEM even  
 ‘We even finished them straight-away (it was) on that day.’ 130921-1,  
 0.59 🔊

Another verb which occurs almost exclusively as the final member of an SVC in my corpus (72 attestations) is  $\sqrt{ana}$  which converts activities into accomplishments with a focus on the resulting state of the accomplishment. (This insight comes from the analysis of the equivalent Kupang Malay verb *ame* ‘take’ discussed in Jacob & Grimes 2011: 349f.) In addition to the aspectual function, it sometimes indicates the object of the SVC has on-going discourse relevance. It is glossed RES ‘resultative’. Two examples are given in (201) and (202) below.

- (201) *siin n-seen n-ana ?rean?=ees.*  
 sini n-sena n-ana ?reno?=esa  
 3PL 3-plant\M 3-RES\U lemon=one  
 ‘They (had) planted a lemon tree.’ 130823-2, 0.24 🔊
- (202) *n-bain he au u-taan ?-aan =koo raasç=ees.*  
 n-bani he au u-tana ?-ana =koo rasi=esa.  
 3-let\M IRR 1SG 1SG-ask\M 1SG-RES\M =2SG.ACC matter=one  
 ‘Let me ask you about something.’ 130825-6, 18.34 🔊

Example (201) is the first event of its story, with the rest of the story revolving around what happens because of this particular lemon tree. (The full version of this text is given in §7.5.) Similarly, in example (202) the speaker interrupts the main storyteller to have him change topic. The act of asking is irrelevant, the speaker being interested in its desired result: the contents of the new topic.

The verb  $\sqrt{rari}$  ‘finish’ can occur as an independent verb. It also frequently occurs as the second member of an SVC with a completive meaning. The difference



between  $\sqrt{ana}$  and  $\sqrt{rari}$  in SVCs lies in the part of the event which each verb emphasises. With  $\sqrt{ana}$ , the focus is on the resulting state of the event, while with  $\sqrt{rari}$  the focus is on the event itself. Two examples of  $\sqrt{rari}$  as the second member of an SVC are given in (203) and (204) below.

- (203) *saap au ʔ-soi? u-rair.*  
 saap au ʔ-soʔi u-rari  
 because 1SG 1SG-count\M 1SG-finish\M  
 ‘Because I’d finished counting.’ 130825-6, 0.36 🔊
- (204) *haeʔ, a-skau-t=aan, a/m-bukae m-raardʒ=een?*  
 haeʔ a-skau-t=ana, m-bukae m-rari=ena  
 hey NML-invite-NML=2DET 1PX/2-eat 1PX/2-finish\M=INCEP  
 ‘Hey inviter/host, have you eaten?’ 130825-7, 2.29 🔊

The verb  $\sqrt{Vma}$  ‘come’ occurs as an independent verb as well as the second member of an SVC indicating action oriented toward the speaker.<sup>17</sup> Two examples of this verb as the second member of an SVC indicating speaker oriented action are given in (205) and (206) below.

- (205) *oka =t m-ʔeer uma m-bi ia.*  
 okeʔ =te m-ʔere uma m-bi ia  
 after.that 1PX/2-look.intently\M 1/2SG\come\U 1PX/2-RL.LOC 1DEM  
 ‘After that, keep looking this way.’ 130907-3, 7.36 🔊
- (206) *tuaf=esa n-fain neem, kaan-n=ee nai? Tuʔas.*  
 tuaf=esa n-fani nema kana-n=ee nai? Tuʔas  
 person=one 3-return\M 3\come\M name-3SG.GEN=3DET Mr. Tuʔas  
 ‘One person came back (here), his name was Tuʔas.’ 130821-1, 5.00 🔊

### 6.7.1 Phonological restrictions on M-forms in SVCs

In both the nominal phrase and the verb phrase M-forms mark the presence of a dependent modifier. However, in the nominal phrase all heads occur in the M-form while in the verb phrase only vowel-final verbs occur in the M-form, and then only when the following verb begins with a single consonant.

When a consonant-final verb occurs as the first member of an SVC it occurs in the U-form. Such phonologically predictable U-forms are glossed \U, and are

<sup>17</sup>The verb  $\sqrt{Vma}$  ‘come’ has an irregular conjugation, discussed in §A.1.1 on page 441.)

6 Syntactically driven metathesis

discussed in more detail in §7.4.2. Two examples of consonant-final verbs as non-final within an SVC are given in (207) and (208) below.

- (207) *au msa? =at au ?-poi ?-pori? ?-aan oa.*  
*au msa? =te au ?-poi ?-pori? ?-ana oa*  
 1SG also =SUB IRR 1SG-exit 1SG-throw\ŭ 1SG-RES\M water  
 ‘Me too, I’ll go out to relieve myself (throw water).’ 130825-7, 3.10 🔊

- (208) *iin na-honi? n-ain ri?ana? nua*  
*ini na-honi? n-ani ri?ana? nua*  
 3SG 3-birth\ŭ 3-before\M child two  
 ‘She first gave birth to two children.’ 130821-1, 7.18 🔊

Similarly, when a vowel-final verb occurs before a consonant cluster it usually occurs in the U-form. Such verbal U-forms are mostly phonologically predictable and are also glossed \ŭ (§7.4.3). Two examples of an SVC in which the second member begins with a cluster are given in (209) and (210).

- (209) *hai mi-sopu m-rair Roma, ees nean haa-?=ii.*  
*hai mi-sopu m-rari Roma esa neno haa-?=ii*  
 1PX 1PX/2PL-complete\ŭ 1PX/2-finish\M Roman COP day four-ORD=1DET  
 ‘We’d completed (reading) Romans on Thursday.’ 130921-1, 0.43 🔊

- (210) *sa- n-ak, he m-sanu m-fain he mi-ah*  
*3-ak he m-sanu m-fani he mi-ah*  
 3-say IRR 1PX/2-descend\ŭ 1PX/2-back\M IRR 1PX/2PL-eat  
 ‘he thought we would go back down to eat.’ 130825-7, 2.24 🔊

A vowel-final verb can occur in the M-form before a verb with an initial consonant cluster. This is the minority pattern in my corpus with 13 attestations compared with 198 attestations of a vowel-final U-form in the same environment. One example is given in (211a) below, which is immediately followed by another speaker who repeats the same SVC, though with an initial U-form.

- (211) A man who’s already made preparations for his funeral: 130913-1 🔊  
 a. *α: m-ak iin n-hain n-mees?*  
*m-ak ini n-hani n-mese*  
 1PX/2-say 3SG 3-dig\M 3-alone\M  
 ‘Do you think he dug it alone?’ 0.57

- b. β: *iin ofa n-hani n-mees.*  
 ini ofa n-hani n-mese  
 3SG sure 3-dig\ŭ 3-alone\M  
 ‘He must’ve dug it alone.’

0.59

When a consonant-final verb occurs before a consonant cluster either epenthesis takes place, as in (212) below, or the cluster of three consonants is not resolved, as in (213) below.

- (212) *t-pe~pea mes baptua Banus iin na-barab a/n-rair*  
 t-pe~peo mes baptua Banus ini na-barab n-rari  
 1PI-INTNS~talk but old.father Banus 3SG 3-prepare\ŭ 3-finish\M  
 ‘We’re talking about it, but father Banus is prepared.’ 130913-1, 2.30 🔊
- (213) *neem he t-ʔonen t-pasat t-aan=ee.*  
 nema he t-ʔonen t-pasat t-ana=ee  
 3\come\M IRR 0-pray\ŭ 0-whack.away\ŭ 1PI-RES\M=3SG.ACC  
 ‘He comes to have it prayed away.’ 120923-1, 6.59 🔊

Consonant-final verbs always occur in the U-form when they are a member of an SVC. This phonotactic restriction is also found with unassimilated consonant-final loan nominals in attributive phrases (§6.3.1). Similarly, when a non-final verb in an SVC is followed by a consonant cluster, it usually occurs in the U-form. This behaviour is different from (native) nominals followed by an attributive modifier in which M-forms are obligatory no matter the phonotactic shape of the nominal and modifier.

To partly account for this fact we can posit that different word classes are sensitive to different phonotactic constraints. Within the nominal phrase preservation of a final consonant is less important than marking the presence of an attributive modifier. Within the verb phrase preservation of a final consonant is more important than marking a following modifier.

## 6.8 A prosodic analysis

It is possible to analyse the metathesis discussed in this chapter as a prosodic process whereby each member of an attributive phrase is a part of a compound with metathesis being triggered by an internal prosodic word boundary. While such an analysis is possible, I conclude by maintaining the morphological analysis originally proposed in §4.3.

## 6 Syntactically driven metathesis

In this chapter I have treated attributive modification as occurring within the syntax. However, such modification can also occur in the morphology. Under such an approach, attributive phrases would be analysed as compounds.

With this analysis, attributive phrases such as *neon mese?* [ˌnɛ.ɔnˈmɛsɛʔ] ‘first day’ would be analysed as compounds, and hence a single word, while phrases which are non-attributive, such as *nenō mese?* [ˌnɛnɔˈmɛsɛʔ] ‘one day’, would constitute two separate words.

The different structures of these two phrases under this analysis are shown in (214) and (215) respectively, in which the prosodic structures are further linked to their syntactic structures. I leave aside for the moment the analysis involving empty C-slots (§3.3.7).

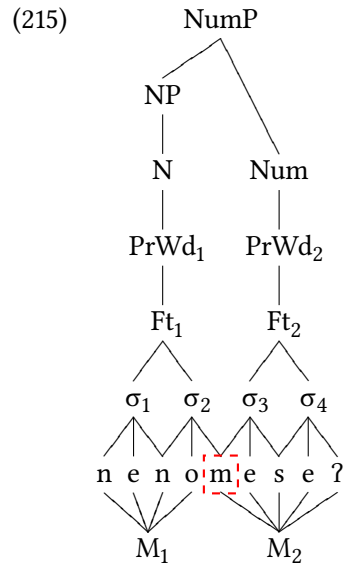
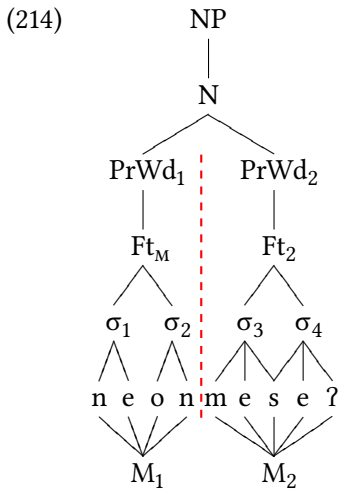

The attributive phrase *neon mese?* ‘first day’ in (214) consists of two prosodic words which are linked to a single syntactic word, while for the non-attributive phrase *nenō mese?* ‘one day’ in (215) each prosodic word is linked to separate syntactic words.<sup>18</sup> As illustrated by the red line in (214), the attributive phrase has a crisp edge between each prosodic word while the non-attributive phrase does not. Metathesis could thus be analysed as an automatic response to a crisp edge constraint.

<sup>18</sup>In each phrase the individual morphemes must be assigned individual prosodic words as each bears penultimate primary or secondary stress.

In Chapter 5 I proposed that metathesis before vowel-initial enclitics occurs in response to a constraint CRISP-EDGE[PrWd] which prohibits elements from being linked to more than one prosodic word. This constraint could be reformulated to only disallow fuzzy borders after *internal* prosodic words, while allowing them between prosodic words which do not share a higher prosodic structure.

Individual syntactic words, such as N, Num, and so on, would be prosodic elements under this analysis. This means that the prosodic words of attributive phrases are internal prosodic words, while those of a non-attributive phrase are not, as represented in (214) and (215) above.

As it currently stands this analysis does account for metathesis of CVC# final roots which are the first member of an attributive phrase in examples such as *muʔit* ‘animal’ + *fui* ‘wild’ → [NP *muiʔfui*] ‘wild animal’, as such phrases would already have an internal prosodic word boundary as shown in unattested (216).

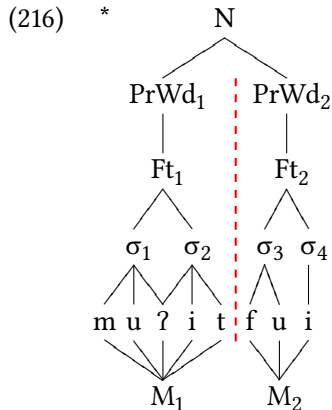

To account for this, we could propose that nominal attribution is marked by consonant deletion. That is, the construct form is fundamentally marked by a morphological rule of subtraction. Subtraction creates an illicit fuzzy border in which the first consonant of the third syllable is also the final consonant of the second syllable and thus shared between two prosodic words, as represented in (217a). This is resolved by metathesis which creates a crisp edge at the internal prosodic word boundary, as illustrated in (217b).

6 Syntactically driven metathesis

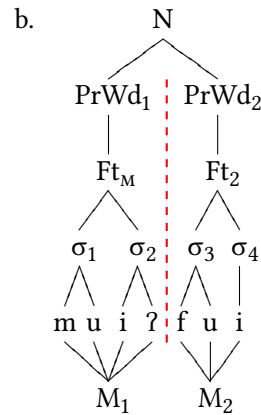
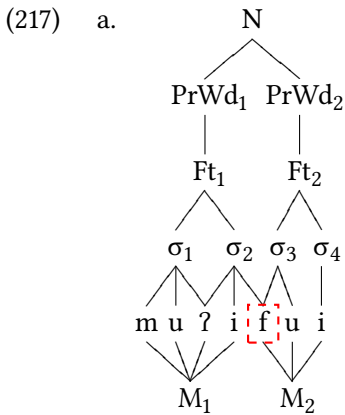

While this analysis may initially seem somewhat counter-intuitive, it is in fact consistent with the history of nominal M-forms in which consonant deletion historically preceded metathesis, as discussed in §4.5.3.

Under this analysis serial verb constructions would similarly be viewed as compounds. Metathesis of CV# final verbs when they are the first member of an SVC occurs for the same reason as it does for nouns: to create a crisp edge between the internal prosodic words of the compound. This is represented in (218) below for *mi-sopu + m-ain* → *mi-soup m-ain* ‘(we) first completed’.

The lack of metathesis for CVC# final verbs (§6.7.1), such as *na-honi? n-ain* ‘(she) first gave birth’ can be explained by the fact that there is already a crisp edge between the prosodic words of this SVC, as represented in (219). We would simply posit that, unlike nouns, deletion of final consonants is not a marker of attribution for verbs. This could be explained by the fact that deletion of final consonants is already used to derive nouns from verbs (§6.2.1).

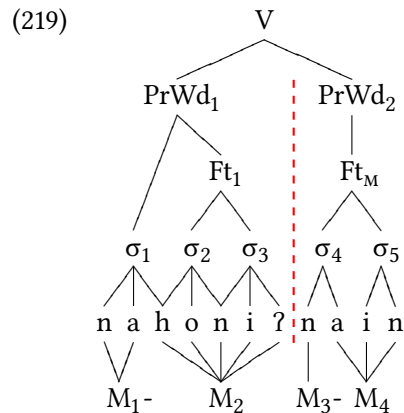
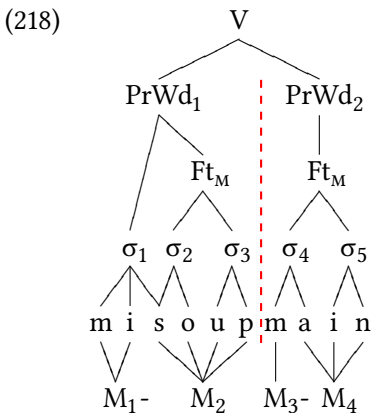

This prosodic analysis encounters no problems in accounting for consonant deletion before modifiers with an initial consonant cluster (§4.6.1), such as in *muʔit* ‘animal’ + *mnasiʔ* ‘old’ → *muʔi mnasiʔ*. After consonant deletion occurs to mark nominal attribution, the resulting structure has a crisp edge between each prosodic word, as shown in (220).

However, the prosodic analysis does not deal straightforwardly with consonant deletion of VVC# final nouns, as seen in *kaut* ‘papaya’ + *sufaʔ* ‘blossom’ → *kau sufaʔ* ‘papaya blossom’. Consonant deletion in this case results in an illicit fuzzy border between the prosodic words, as shown in (221). Metathesis cannot occur due to the structure of the first noun, and thus this fuzzy border is left unresolved.<sup>19</sup>

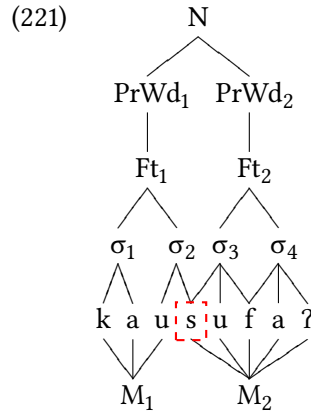
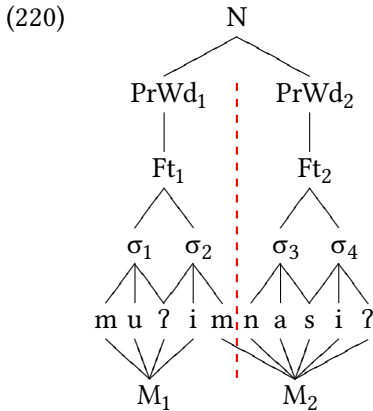

To account for the problems involved in the analysis of VVC# final words under the prosodic analysis, we can reintroduce empty C-slots, and posit that metathesis has indeed occurred in *kau sufaʔ* ‘papaya blossom’, as shown in (222) in which there is a crisp edge between each prosodic word.

<sup>19</sup>In the case of (221) we might expect vowel deletion to occur to resolve the fuzzy border giving unattested *kaut* ‘papaya’ + *sufaʔ* ‘blossom’ → \**ka sufaʔ*, or we might expect consonant deletion to be blocked to preserve the prosodic word boundary.

6 Syntactically driven metathesis

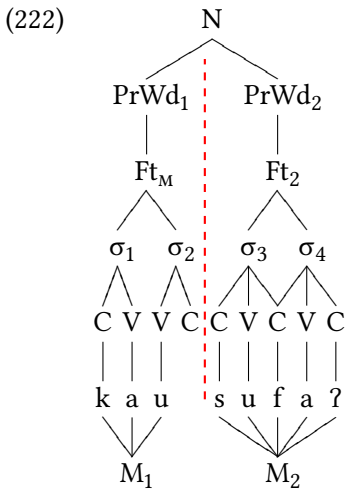

However, the reintroduction of empty C-slots is problematic for the analysis of verbal metathesis in SVCs. Because consonant deletion is not a marker of attribution for verbs, a vowel-final verb such as *mi-sopu* ‘(we) complete’ would end in an empty C-slot which would be retained when it occurs in an SVC, thus resulting in a crisp edge after the first internal prosodic word edge, as represented in unattested *\*mi-sopu m-ain* ‘(we) first completed’ given in (223). The attested structure is *mi-soup m-ain* given in (218) above and repeated with the CV-tier shown in (224) below.

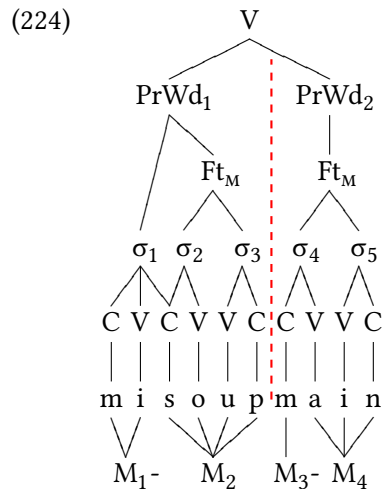
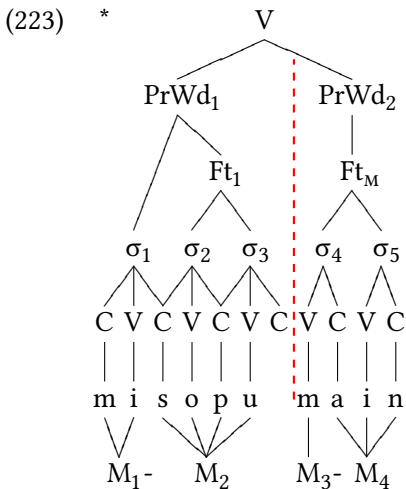

Under the prosodic approach it seems that the analyst must decide whether to deal with verbal metathesis in the same way as nominal metathesis, or whether



to introduce empty C-slots and thus deal with the M-form of VVC# nominals in the same way as other nominals.<sup>20</sup>

However, probably the most serious issue with the prosodic analysis is that there is no independent evidence that attributive phrases actually have a structure in which prosodic words share a higher prosodic category. The only evidence for such a structure is the metathesis; the very phenomenon we are trying to explain by positing such a structure.

This is contrary to metathesis before enclitic boundaries whereby the clitic host unexpectedly bears stress, thus providing evidence for a recursive prosodic word structure  $_{PrWd}[_{PrWd}[HOST]=cl]$ , with the internal prosodic word of the host linked to a higher prosodic word containing both the host and the enclitic

### 6.8.1 Summary

Metathesis before attributive modifiers can be analysed prosodically, as proposed in this section, or as a morphological process as proposed in §4.3. The main strengths and weaknesses of each analysis, as I currently see them, are given in (225) and (226).

#### (225) Morphological Analysis

- a. Strengths:
  - i. accounts for VVC# final nouns in the same way as other nouns
  - ii. makes use of empty C-slots (posited based on other evidence)
- b. Weaknesses:
  - i. no explanation for lack of metathesis for C-final verbs in SVCs
  - ii. inconsistent with diachronic development of nominal M-forms whereby consonant deletion precedes metathesis (§4.5.3)

#### (226) Prosodic Analysis

- a. Strengths:
  - i. consistent with the diachronic development of nominal M-forms
  - ii. good explanation for lack of metathesis for C-final verbs in SVCs

---

<sup>20</sup>This is an oversimplification and ignores other possibilities such as only positing medial empty slots and/or only positing the obligatory CVCVC foot for nouns. However, in my view, the strongest evidence for empty C-slots in Amarasi comes from the process of consonant insertion at clitic boundaries (§5.3) and word-final consonant insertion in other varieties of Meto (§3.3.7.6) – both processes which provide evidence for final empty C-slots for all word classes.

## 6 Syntactically driven metathesis

### b. Weaknesses:

- i. M-form of VVC# final nouns is unexpected
- ii. empty C-slots introduce complications
- iii. requires positing otherwise unsupported prosodic structures

Two additional facts must be born in mind when deciding between the two analyses. Firstly, adopting the prosodic analysis is not the same as analysing metathesis as phonologically conditioned. It is well worth repeating that the only phonological difference between attributive and non-attributive phrases is often the order of the final CV sequence of the first noun.

The examples involving cardinal and ordinal numerals from the beginning of this chapter are repeated in (227) and (228) below. At the risk of labouring the point, the stress of these phrases are identical, the number of vowels of these phrases are identical, and the intonation is identical. The only difference is the metathesis.

- |                                                                                                                                                                                                       |                                                                                                                                                                          |
|-------------------------------------------------------------------------------------------------------------------------------------------------------------------------------------------------------|--------------------------------------------------------------------------------------------------------------------------------------------------------------------------|
| <p>(227)     ,nɛnɔ            'mɛsɛʔ<br/>                 [<sub>NP</sub> <i>neo</i> ] [<sub>Num</sub> <i>meseʔ</i> ]<br/>                 day\U            one\U<br/>                 'one day' ◀</p> | <p>(228)     ,nɛ.ɔn 'mɛsɛʔ<br/>                 [<sub>NP</sub> <i>neon meseʔ</i> ]<br/>                 day\M one\U<br/>                 'first day (i.e. Monday)' ◀</p> |
|-------------------------------------------------------------------------------------------------------------------------------------------------------------------------------------------------------|--------------------------------------------------------------------------------------------------------------------------------------------------------------------------|

Instead, with the prosodic analysis, metathesis itself is a realisation of the prosody. In most languages prosodic structures are realised by suprasegmental features such as stress and/or intonation. Under the prosodic analysis Amarasi has an additional feature which encodes prosodic structures: the order of the segmental material in post-tonic syllables.

If the prosodic analysis is taken, then I would agree with Himmelmann & Kaufman (to appear) that Amarasi metathesis is a prosodic cue for phrasing. Though, I am not sure that I would agree with them that “VC-metathesis appears to be rooted in phonological phrasing.”

The second point which should be born in mind when deciding on the best analysis of metathesis in the syntax is that this is only one aspect of Amarasi metathesis. As I discuss in Chapter 7, metathesis also occurs in the discourse to encode resolved and unresolved events. Given that neither metathesis occurs in a specific phonological environment (unlike the phonological metathesis discussed in Chapter 5) it is reasonable to expect both kinds of metathesis to be analysed in a similar way. If a prosodic analysis of metathesis in the syntax is adopted, then we would expect that this can also be extended to the discourse, and vice-versa.

It is this last point which has mainly led me to analyse syntactically driven metathesis as a morphological process. I have been unable to come up with a plausible prosodic analysis which would cover metathesis in both the syntax and the discourse. It may be that this shortcoming lies not with the data but with the analyst. If this is the case then I would urge those who might favour a prosodic analysis of metathesis to examine the Amarasi data carefully and propose an analysis which is faithful to this data. In the end, my primary commitment is not to any particular analysis, but to the data on which any analysis must be based.

## 6.9 Conclusion

Syntactic metathesis in Amarasi is a morphological process used to mark the presence of a following attributive modifier. It is a construct form (§2.6.1) used to mark that a word of the same word class as the head is dependent on the head. Syntactic metathesis affects every non-final word below the level of  $\bar{X}$ .

A syntactic M-form canonically co-occurs with a following U-form. A syntactic M-form cannot occur at the end of a phrase and thus entails the presence of a following U-form which syntactically completes any prior M-form. Within the syntax M-forms and U-forms comprise a parallel and complementary pair of morphological forms; they are a dyadic set, with each form being one half of a whole. The complementary and parallel nature of syntactic M-forms and U-forms in Amarasi is represented in Figure 6.1.

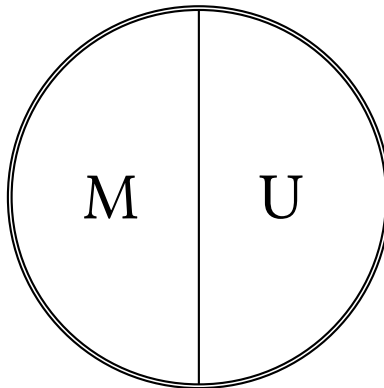

Figure 6.1: Amarasi syntactic metathesis



# 7 Discourse-driven metathesis

## 7.1 Introduction

In this chapter I analyse the morphological use of metathesis in Amarasi to mark discourse structures. The final member of a phrase or clause uses metathesis to mark that the situation/event encoded by the clause is unresolved and requires another clause to achieve resolution. A discourse U-form (unmetathesised) typically occurs in a parallel and complementary relationship with an M-form (metathesised), the latter of which resolves the former.

Example (1) is a question-answer pair in which a question with a final U-form is resolved by an answer in the M-form. Example (2) contains two events. The second event is encoded in the M-form and is dependent on the prior clause with a final U-form for its realisation.

- (1) Q: *hoo* *mu-beʔi*?                      A: *au* *u-beiʔ!*  
       *hoo* *mu-beʔi*                                      *au* *u-beʔi*  
       2SG 2SG-capable\U                                      1SG 1SG-capable\M  
       ‘Can you do it?’                                      ‘Yes I can!’                      observation 02/08/13, p.20
- (2) *m-ak*    *hai nua =kai*    *m-taikobi*    =*m*    *hai*    *m-maet*    *oke?*  
       *m-ak*    *hai nua =kai*    *m-taikobi*    =*ma*    *hai*    *m-mate*    *oke?*  
       1PX/2-say 1PX two 1PX.ACC 1PX/2-fall\U =and 1PX 1PX/2-die\M all  
       ‘So we two will fall down and (then) both die.’                      130909-6, 0.39 🔊

Discourse U-forms are used by speakers to signal that the event or situation is not resolved. Such a U-form represents half of a whole which requires resolution by another clause. Discourse-driven U-forms leave the audience in a state of suspense with the speaker signalling that more information is required to resolve the situation or event encoded by a clause with a final U-form.

Nearly all word classes which are not canonical nominals (as defined in §6.2) have discourse-driven U-forms. These word classes are listed in (3) below. I refer to these word classes as *non-nominals* throughout this chapter. The label ‘non-nominal’ is not ideal as place names, demonstratives, and pronouns all have many

nominal characteristics. However, there does not seem to be a more appropriate term which covers all of the word classes in (3).

- (3) Word classes with discourse-driven U-forms:
- a. verbs
  - b. numerals
  - c. place names
  - d. number enclitics (*eni* ‘PL’, *=esa*, ‘one’)
  - e. demonstratives (*nana* ‘2DEM’)
  - f. determiners (*=ana* ‘2DET’)
  - g. pronouns (*ini* ‘3SG’, *sini* ‘3PL’, *hiti* ‘1PI’)
  - h. adverbials (*=ena* ‘INCEP’, *=aha* ‘just’)

The use of U-forms is productive for verbs, numerals, and place names. For the other word classes listed in (3), particularly the number enclitic *=eni* ‘PL’, the adverbials *=ena* ‘INCEP’ or *=aha* ‘just’, as well as the demonstratives and determiners, the use of U-forms is less productive, though there are still many instances in which U-forms with these latter classes signal a lack of resolution.

Discourse U-forms typically occur in certain constructions and environments. These constructions and environments include dependent coordination (§7.6), tail-head linkage (§7.7), poetic parallelism (§7.8), chiasmus (§7.9) and interactions between speakers (§7.10). These five constructions are summarised in Table 7.1 above along with the typical structure of each. There are 423 discourse-driven U-forms in my corpus. Of these, 406 (96%) clearly occur in one of the five constructions/environments given in Table 7.1.<sup>1</sup>

Before I discuss the details of U-forms in Amarasi discourse, I discuss several other facts which provide helpful background information: the co-occurrence of syntactically driven M-forms and discourse-driven U-forms (§7.2), the fact that the M-form is the semantically unmarked form of non-nominals (§7.3), phonotactic constraints which block the use of discourse U-forms (§7.4), and some of the general structures of Amarasi discourse (§7.5).

---

<sup>1</sup>With 423 attestations, discourse (un)metathesis is a well-attested morphological process. For comparison, my corpus has 152 instances of partial reduplication (§3.3.5) and 48 of the reciprocal prefix *ma(k)*- (§A.1.2).

Table 7.1: Constructions in which discourse U-forms typically occur<sup>†</sup>

| Construction           | Typical Structure |       |
|------------------------|-------------------|-------|
| Dependent coordination |                   | §7.6  |
| Tail-head linkage      |                   | §7.7  |
| Poetic parallelism     |                   | §7.8  |
| Chiasmus               |                   | §7.9  |
| Interaction            |                   | §7.10 |

<sup>†</sup> An arrow indicates the form which resolves a U-form and a line joining two forms indicates forms which are semantically identical or parallel. Event<sub>1</sub> and event<sub>2</sub> refer to two different events or situations, with event<sub>1</sub> beginning before event<sub>2</sub>.

## 7.2 Syntactically and discourse-driven metathesis

Discourse-driven U-forms occur with the final members of phrases, while syntactically driven M-forms occur with the medial members of phrases. As a result, they are in complementary distribution and there is no competition between these two morphological uses of metathesis. Two illustrative examples are given in (4) and (5) below.

In (4) the first member of the serial verb construction *ta-hiin t-ana* ‘figure out, get to know’ occurs in the M-form to mark that it is modified by the second verb, as discussed in §6.7, while the final verb occurs in the U-form to signal that the entire verb phrase requires more information to achieve resolution. See example (61) on page 357 for more discussion of (4) and its context.

- (4) *siin neem na-tua Koor?oot ees re? oras mee*  
*sini neem na-tua Koor?oto esa re? oras mee*  
 3PL 3\come 3-settle Koro'oto\M COP REL time where  
*ka= ta-hiin t-ana =f.*  
*ka= ta-hini t-ana =f.*  
 NEG= 0-know\M 0-RES\U =NEG

‘They came and settled in Koro’oto, it was at a time which hasn’t been figured out.’ 160326, 5.37 

Similarly, in (5) below the first member of the noun phrase *kaan auk-k=eni* ‘praise names’ occurs in the M-form to signal that it is modified by the following nominal, as discussed in Chapter 6. This nominal in turn occurs in the M-form due to the following vowel-initial enclitic, as discussed in Chapter 5. The final member of this phrase is the number enclitic *=eni* ‘PL’ which occurs in the U-form to signal that the entire phrase requires more information to achieve resolution. See example (64) on page 359 for more discussion of this example.

- (5) *siin nai? Bain mone kusus,*  
*sini nai? Bani mone kusus*  
 3PL Mr. Bani\M male exclusive  
*siin kaan auk-k=eni* *bisa, Mea ai? Tutun.*  
*sini kana aku-k=eni* *bisa Mea ai? Tutun*  
 3PL name\M praise.name\M-3PL/1GEN=PL\U can Mea or Tutun

‘Members of the Bani clan classified as male can exclusively have the praise names Mea or Tutun.’ 160326, 18.26 

To summarise, syntactically driven M-forms only occur with medial members of phrases, while discourse driven U-forms only occur with final members of phrases. As a result, there is no competition between them. In a single phrase the medial members can occur in the M-form to signal the internal syntactic structure of the phrase, while the final member can occur in the U-form to signal the discourse status of the entire phrase.

### 7.3 Default M-form

For the non-nominal word classes given in (3) above the default semantic form is the M-form (see §7.4 for exceptions). Even though the M-form of these word classes is the semantically default form, the U-form must still be posited as the



morphologically underlying form. This can be shown by the processes of vowel assimilation which occur in the formation of M-forms (§4.2.2). Two examples of minimal pairs with identical M-forms but different U-forms are  $\sqrt{nene}$  ‘press’ and  $\sqrt{nenā}$  ‘hear’ →  $n-neen$  ‘presses’/‘hears’ as well as  $\sqrt{rene}$  ‘field’ and  $\sqrt{rena}$  ‘force’ →  $na-reen$  ‘makes a field’/‘forces’.

For these word classes, the morphologically unmarked form is the semantically marked form with special discourse uses (unresolved), and the morphologically marked form is the semantically unmarked form without special discourse uses. This difference between nominals and other word classes is shown in Table 7.2.

Table 7.2: Nominal and non-nominal metatheses

|         | unmarked<br>semantics | marked<br>semantics |
|---------|-----------------------|---------------------|
| nominal | U-form                | M-form              |
| other   | M-form                | U-form              |

Most of the discussion in this section focusses on verbs as these are the most well-attested word class with default M-forms, though the statements also hold for the other non-nominal word classes. The M-form of these word classes is the form used in simple declarative sentences, the citation form, and the most common form. Three simple declarative sentences are given in (6)–(8) below. Each of these examples is taken from the very beginning of its text. The verb in each instance take the M-form.

- (6) *nenō ia aam Nahor Bani iin n-maet.*  
 nenō ia ama Nahor Bani ini n-mate  
 day 1DEM father Nahor Bani 3SG 3-die\M  
 ‘Today father Nahor Bani died.’ 130928-1, 0.02 🔊
- (7) *krei ia iin naan-n=ii, hai m-rees surat Roma.*  
 krei ia ini nana-n=ii, hai m-resa surat Roma  
 week 1DEM 3SG inside-3SG.GEN=1DET 1PX 1PX/2-read\M paper Romans  
 ‘During this week we read the book of Romans.’ 130920-1, 0.22 🔊
- (8) *ahh, hai m-baiseun fuunn=ee =te, ahh*  
 hai m-baisenu funan=ee =te  
 1PX 1PX/2-look.up\M moon=3DET =SUB  
 ‘Umm, when we looked up at the moon,’ 120715-3, 0.10 🔊

As the default form, the M-form is also the usual citation form. The citation forms of a number of vowel-final verbs and numerals in one recorded wordlist are given in (9) below. Verbs occur with the 3SG agreement market (*a|*)*n*- or *na*-.

(9) Vowel final verb and numeral citation forms:

| Root          |   | Citation        |                    |
|---------------|---|-----------------|--------------------|
| √ <i>henu</i> | → | <i>na-heun</i>  | ‘fill, is full’    |
| √ <i>hini</i> | → | <i>na-hiin</i>  | ‘know’             |
| √ <i>ita</i>  | → | <i>n-iit</i>    | ‘look at’          |
| √ <i>kisu</i> | → | <i>a n-kius</i> | ‘see’              |
| √ <i>mate</i> | → | <i>n-maet</i>   | ‘die’              |
| √ <i>nenā</i> | → | <i>a n-neen</i> | ‘hear’             |
| √ <i>roʔa</i> | → | <i>a n-rooʔ</i> | ‘vomit’            |
| √ <i>roro</i> | → | <i>a n-roor</i> | ‘kill by stabbing’ |
| √ <i>tenu</i> | → | <i>teun</i>     | ‘three’            |
| √ <i>nima</i> | → | <i>niim</i>     | ‘five’             |
| √ <i>hitu</i> | → | <i>hiut</i>     | ‘seven’            |
| √ <i>fanu</i> | → | <i>faun</i>     | ‘eight’            |

For nominals, the semantically default form is the U-form, with the M-form marking modification (see Chapter 6). There are a number of roots in Amarasī which can occur as either a verb or nominal. Such roots are cited in U-form for the nominal meaning and the M-form for the verbal meaning. Examples are given in Table 7.3 below.

Table 7.3: Citation forms of noun-verb pairs

| Root           | Nom.           | Gloss (N.)   | Verb            | Gloss (V.)     |
|----------------|----------------|--------------|-----------------|----------------|
| √ <i>heʔo</i>  | <i>heʔo</i>    | ‘(a) saw’    | <i>n-heoʔ</i>   | ‘(to) saw’     |
| √ <i>ʔsoko</i> | <i>ʔsoko</i>   | ‘sign’       | <i>na-ʔsook</i> | ‘make a sign’  |
| √ <i>nope</i>  | <i>nope</i>    | ‘cloud’      | <i>n-noep</i>   | ‘be cloudy’    |
| √ <i>reko</i>  | <i>reko</i>    | ‘good’       | <i>na-reok</i>  | ‘be good’      |
| √ <i>rono</i>  | <i>rono-f</i>  | ‘saliva’     | <i>n-roon</i>   | ‘(to) spit’    |
| √ <i>siʔu</i>  | <i>siʔu-f</i>  | ‘(an) elbow’ | <i>n-siuʔ</i>   | ‘(to) elbow’   |
| √ <i>snasa</i> | <i>snasa-f</i> | ‘breath’     | <i>na-snaas</i> | ‘take a break’ |

The M-form is also the most frequent form for non-nominals. In my corpus M-forms comprise 73% (3,858/5,271) of non-nominals. After excluding M-forms

which are obligatory before vowel-initial enclitics (544 instances), U-forms which are consonant-final stems (556 instances), and U-forms before consonant clusters (435 instances), M-forms constitute 89% (3,313/3,736) of the relevant word classes. Put differently, the semantically unmarked form occurs in 89% of instances. The figures for each word class are detailed in Table 7.4.

Table 7.4: Frequency of U-forms and M-forms in texts<sup>†</sup>

|                  | U-form | /_CC | /C# | else. | M-form | /_ =V | else. |
|------------------|--------|------|-----|-------|--------|-------|-------|
| verbs            | 1,077  | 350  | 441 | 286   | 1,913  | 440   | 1,473 |
| numerals         | 41     | 2    | 26  | 13    | 76     | 25    | 51    |
| place names      | 99     | 0    | 89  | 10    | 51     | 4     | 47    |
| <i>esa/=esa</i>  | 79     | 41   | 0   | 38    | 375    | 39    | 336   |
| eni              | 21     | 3    | –   | 18    | 171    | 26    | 145   |
| pronouns         | 46     | 30   | –   | 16    | 987    | 10    | 977   |
| dem./det.        | 24     | 4    | –   | 20    | 144    | 0     | 144   |
| <i>=ena/=aha</i> | 27     | 5    | –   | 22    | 140    | 0     | 140   |
| total            | 1,414  | 435  | 556 | 423   | 3,857  | 544   | 3,313 |

<sup>†</sup> U-form = total U-forms, /\_CC = U-forms before consonant clusters, /C# = consonant-final stems in U-form, else. = U-forms elsewhere (discourse-driven U-forms), M-form = total M-forms, /\_ =V = M-forms before vowel-initial enclitics, else. = other M-forms

M-forms are the semantically default form for verbs, numerals, number enclitics, place names, pronouns, demonstratives, determiners, and adverbials. For these word classes U-forms normally mark an unresolved event or situation.

## 7.4 Phonotactic constraints

There are several phonotactic/phonological environments which block the use of U-forms to signal lack of resolution. The end result of these different phonotactic constraints is that only non-nominals which end in CV# have morphological uses of U-forms, and then only when not followed by a vowel-initial enclitic or word with an initial consonant cluster.

Firstly, and most obviously, stems which end a vowel sequence do not have (surface) alternate U-forms and M-forms (§4.2.6). Thus, such stems cannot use U-forms to morphologically signal lack of resolution.

Other situations in which the phonology overrides or blocks the morphology with the result that U-forms do not mark lack of resolution include when vowel-

initial enclitics occur attached to a stem (§7.4.1), when a stem is consonant final (§7.4.2), and when a stem is followed by a consonant cluster (§7.4.3). Each of these different environments is discussed in turn in the following sections.

#### 7.4.1 Vowel-initial enclitics

As discussed in Chapter 5, M-forms are obligatory before vowel-initial enclitics. When a non-nominal occurs with a vowel-initial enclitic, it obligatorily occurs in the M-form and it is not possible to mark lack of resolution with the clitic host. However, if the vowel-initial enclitic itself has alternate U-forms and M-forms, lack of resolution of the clause can be signalled by this vowel-initial enclitic taking the U-form. One example is given in (10) below – a typical question asked around the village.

- (10) *hoo m-faanɕ=ena ?*  
 hoo m-fani=ena  
 2SG 1PX/2-return\M̄=INCEP\U  
 ‘So, you’re going back now?’ observation

In (10) the clitic host *m-faanɕ* ‘return’ occurs in the M-form due to the following vowel-initial enclitic. As a result, it is not possible to mark that this is a question with this stem (see §7.10 for full discussion of the use of U-forms to mark questions). Instead, the vowel-initial enclitic occurs in the U-form to signal that this clause is a question.

If the vowel-initial enclitic itself does not have metathesis alternations, i.e. if the vowel-initial enclitic ends in a vowel sequence, it is not possible to morphologically mark lack of resolution.

#### 7.4.2 Consonant-final U-forms

Non-nominal stems with a final consonant occur by default in the U-form and do not use U-forms to morphologically signal lack of resolution. Consonant-final non-nominals only occur in the M-form before vowel-initial enclitics. Consonant-final U-forms are glossed  $\backslash\bar{u}$  – U with a *c* for consonant above it – to mark that these are not discourse-driven U-forms. Two examples of simple declarative sentences with consonant-final verbs occurring in the U-form are given in (11) and (12) below.

- (11) *nenō naa paha\_?pina-n ia,*  
 day 0DEM country\_below-3SG.GEN 1DEM  
*a|n-kobub on bare mese?*  
 3-pile.up\ŭ IRR.LOC place one  
 ‘In those days the world was piled up in one place.’ 120715-4, 0.05 🔊
- (12) *n-ak: “hiit ta-nani? kuan=ii, kaisa? Neanpeen.*  
 3-say 1PI 1PI-move\ŭ village=1DET PROH Neanpeen  
 ‘They said: “Let’s change the village, it shouldn’t be Neanpeen.’ 130823-2,  
 0.57 🔊

Similarly, the citation form of consonant-final verbs is the U-form. Examples of consonant-final verbs cited in the U-form in a recorded wordlist are given in Table (13) below.

- (13) Consonant-final verb citation forms:

| Root           | Citation           |                  |
|----------------|--------------------|------------------|
| $\sqrt{?apu?}$ | → <i>na-?apu?</i>  | ‘is pregnant’    |
| $\sqrt{manis}$ | → <i>n-manis</i>   | ‘laughs at s.o.’ |
| $\sqrt{reru?}$ | → <i>a n-reru?</i> | ‘is sleepy’      |
| $\sqrt{sumak}$ | → <i>a n-sumak</i> | ‘dives’          |

This behaviour includes verbs whose final consonant is a suffix, or the consonantal allomorph of the plural enclitic =*n*. The citation forms of a number of vowel-final verbs and their corresponding forms with the plural enclitic =*n* are given in (14) below to illustrate.

- (14) Plural verb citation forms:

| Root          | Verb           | Verb=PL            |         |
|---------------|----------------|--------------------|---------|
| $\sqrt{nema}$ | <i>neem</i>    | → <i>nema=n</i>    | ‘come’  |
| $\sqrt{tona}$ | <i>na-toon</i> | → <i>na-tona=n</i> | ‘tell’  |
| $\sqrt{mate}$ | <i>n-maet</i>  | → <i>n-mate=n</i>  | ‘die’   |
| $\sqrt{eki}$  | <i>n-eik</i>   | → <i>n-eki=n</i>   | ‘bring’ |
| $\sqrt{hini}$ | <i>na-hiin</i> | → <i>na-hini=n</i> | ‘know’  |
| $\sqrt{mepu}$ | <i>n-meup</i>  | → <i>n-mepu=n</i>  | ‘work’  |
| $\sqrt{romi}$ | <i>n-roim</i>  | → <i>n-romi=n</i>  | ‘like’  |

Ro’is Amarasi behaves differently in this respect as stems in which the penultimate or final consonant is /n/ occur in the M-form (and with a final consonant

cluster) by default. U-forms of such stems are then used to signal lack of resolution. Two examples of Ro'is Amarasi sentences with a consonant-final verb in the M-form are given in (15) and (16) below. See §7.11 for more discussion of the use of M-forms with a final cluster in Ro'is Amarasi.

- (15) Ro'is: *siin na-saap=n*.  
 Kotos: *siin na-sapa=n*.  
 3PL 3-kick=PL  
 'They're playing soccer.' observation 08/10/14, p.113
- (16) Ro'is: *raump=ein n-maet=n*.  
 Kotos: *paku=n n-mate=n*.  
 light=PL 3-die=PL  
 'The lights have died.' observation 09/10/14, p.114

Consonant-final non-nominals in Kotos Amarasi take the U-form by default. Such words do not have metathesis alternations to express discourse functions.

### 7.4.3 U-forms before consonant clusters

Another phonotactic environment in which non-nominals do not usually occur in the M-form is before consonant clusters.<sup>2</sup> Before a consonant cluster the usual form of a non-nominal is the U-form and lack of resolution is not morphologically marked. This is similar to the fact that certain nouns do not undergo metathesis before modifiers with an initial consonant cluster, and thus cannot morphologically mark attributive modification (§4.6.2).

Like U-forms with a word-final consonant, U-forms before a consonant cluster are glossed  $\backslash\check{u}$  to distinguish them from discourse-driven U-forms. In my corpus there are over 300 U-forms of verbs before a consonant cluster and only 21 verbal M-forms before a consonant cluster. Two examples of a U-form before a consonant cluster initial root are given in (17) and (18) below.

- (17) *uma*            *?-tee*        *=ma, ?-aiti*        *bruuk*.  
*uma*            *?-tea*        *=ma ?-aiti*        *bruuk*  
 1/2SG\come\check{u} 1SG-arrive =and 1SG-pick.up\check{u} pants  
 'I arrived (home) and picked up some pants.' 130825-6, 10.05 

<sup>2</sup>Functors often occur in the M-form before consonant clusters. This is connected with the fact that the use of the U-form with functors is not fully productive.

- (18) *onai =te, hoo m-tebi      ?teta?*  
 like.this 2SG 1PX/2-turn\U different  
 ‘Like this, you turn (it) differently.’ 130914-1, 0.53 🔊

One of the most frequent kinds of consonant clusters in my corpus are those created through the addition of a verbal prefix to a consonant-initial verb stem (§A.1). This is the most common kind of consonant cluster found after verbal U-forms. Two examples are given in (19) and (20) below.

- (19) *hai m-eki      m-sanu      m-bi      re? ?pinan ia      =t,*  
 1PX 1PX/2-bring\U 1PX/2-go.down\U 1PX/2-RL.LOC TOP below 1DEM =SUB  
 ‘When we went down there,’ 130902-1, 3.41 🔊
- (20) *iin ao-n=ee      n-mese      n-nao n-peo?      aafgw=ii      =m,*  
 ini ao-n=ee      n-mese      n-nao n-pe?o      afu=ii      =ma  
 3SG body-3SG.GEN=3DET 3-alone\U 3-go 3-go.by\M ground=1DET =and  
 ‘His body went by itself along the ground.’ 120715-4, 2.26 🔊

While the vast majority of non-nominals are in the U-form before a consonant cluster, there are 15 instances of an M-form before such words in my corpus. Such examples represent only 7% (21/302) of all verbs before a consonant cluster. Two examples are given in (21) and (22) below.

- (21) *surat a/n-poi n-taam      n-poi n-taam, au ?-toup.*  
 surat n-poi n-tama n-poi n-tama au ?-toup  
 paper\U 3-exit 3-enter\M 3-exit 3-enter\M 1SG 1SG-receive\M  
 ‘Letters would be issued and received, issued and received, I got (one).’  
 130907-3, 8.04 🔊
- (22) *n-eik      kreedz=ii      neem.*  
 n-eki      krei=ii      nema  
 3-bring\M church=1DET 3\come\M  
 ‘(They) brought the Church here.’ 160326, 10.22 🔊

#### 7.4.3.1 Consonant-final stems before consonant clusters

There are 44 instances of a consonant-final stem before a consonant cluster in my corpus. In 14 instances, epenthesis (§3.5) occurs to break up the underlying cluster of three consonants. Two examples are given in (23) and (24) below.

7 Discourse-driven metathesis

- (23) *t-pe~pea mes baap tua Banus iin na-barab a/n-rair*  
*t-pe~peo mes bapa tua Banus ini na-barab n-rari*  
 1PI-INTNS~talk but father old Banus 3SG 3-prepare\ŭ̇ 3-finish\M  
 ‘We talk about it, but father Banus is already prepared.’ 130913-1, 2.30  
 🔊
- (24) *iin n-mooʔɕ=oo-n on kaunʔ=ii =ma n-nonok a/n-peoʔ*  
*ini n-moʔe=oo-n on kaunaʔ=ii =ma n-nonok n-peʔo*  
 3SG n-do\M=REFL-3SG.GEN IRR.LOC snake=1DET =and 3-crawl\ŭ̇ 3-go.by  
*aafgw=ii =ma*  
*afu=ii =ma*  
 ground=1DET =and  
 ‘he did it like the snake and crawled along the ground’ 120715-4, 1.52 🔊

In the remaining 30 examples in my corpus the cluster of three consonants is not phonemically resolved. In all but one case, the first consonant (i.e. the final consonant of the stem) is either the glottal stop /ʔ/ or the alveolar nasal /n/. That epenthesis is not obligatory after these consonants is consistent with the data presented in §3.5, which showed that epenthesis is uncommon between ?\_CC, and only optional between n\_CC.

An example each of final /ʔ/ and /n/ before a consonant cluster is given in (25) and (26) below respectively. In both instances the first consonant of each cluster is phonetically deleted, or has coalesced with the following consonant.

- (25) [i napɐpɐ mə nsiʔi nːaʒ ˈpiʔt]  
*iin na-papaʔ =ma n-siriʔ n-nao piut.*  
 3SG 3-wound\ŭ̇ =and 3-spread\ŭ̇ 3-go continue  
 ‘The wound keeps on spreading.’ 120923-2, 6.28 🔊
- (26) [n̄maˈsenuɔn ɐmːɐ ʔanmɐˈβanə nβin  
*n-ma-senu=n =ama a/n-ma-bana=n n-bi=n*  
 3-RECP-replace\ŭ̇=PL =and 3RECP-hit\ŭ̇=PL 3-RL.LOC=PL  
*rɛʔ nanɔ mɛsɛʔ]*  
*reʔ nanaʔ meseʔ*  
 REL inside but  
 ‘They replaced and fought one another inside.’ 120715-4, 7.56 🔊

Verbs nearly always take the U-form before a word which begins with a consonant cluster. This is because clusters of three consonants are normally disallowed in Kotos Amarasi.



#### 7.4.4 Summary

There are a number of word classes in Amarasi for which the default form is the M-form and for which the U-form is used to signal lack of resolution. These word classes were listed in (3) above, repeated as (27) below.

- (27) Word classes with discourse-driven U-forms:
- a. verbs
  - b. numerals
  - c. place names
  - d. number enclitics (*eni* ‘PL’, *=esa*, ‘one’)
  - e. demonstratives (*nana* ‘2DEM’)
  - f. determiners (*=ana* ‘2DET’)
  - g. pronouns (*ini* ‘3SG’, *sini* ‘3PL’, *hiti* ‘1PI’)
  - h. adverbials (*=ena* ‘INCEP’, *=aha* ‘just’)

Given the phonotactic constraints discussed in this section, it is more accurate to say that members of these word classes which end in CV# have discourse-driven U-forms when they do not occur before a vowel-initial enclitic or a word with an initial consonant cluster.

U-forms of consonant-final non-nominals and U-forms of non-nominals before a consonant cluster are glossed \ŭ when it is necessary to gloss them to distinguish them from U-forms which are used morphologically to mark lack of resolution.

## 7.5 Discourse structures in Amarasi

In this section I discuss the general patterns of Amarasi discourse by means of a detailed exposition of a single short text. This section provides the background for properly understanding the discourse functions of U-forms.

The text selected for exposition is *Kuareno*’, a short narrative text about how the village of *Kuareno*’ came to have its current name.<sup>3</sup> With sixteen clauses, this text is both short enough to allow detailed exposition, and still long enough to illustrate a range of discourse structures. The structure of this text is indicative of other texts.

---

<sup>3</sup>The name *Kuareno*’ is historically from *kuan* ‘village’ + *?reno?* ‘orange *Citrus sinensis*’.

7 *Discourse-driven metathesis*

The outline of this story is given in Table 7.5. In this table I have given a summary of each clause, the part of the plot in which it occurs, which conjunctions occur and the occurrence of U-forms and M-forms on non-nominals.<sup>4</sup> I have also tracked repetition between clauses with the use of capital letters, each of which tracks a unique concept which is repeated. Thus, the *A* in clauses 1, 2, 13, 14, and 16 indicates that each of these clauses contains the same concept (which is not repeated elsewhere), in this case *Kuareno?* ‘Kuareno’. Similarly, *D* in clauses 5 and 6 indicates that these clauses contain the same concept, in this case *?reno?* ‘orange tree’.

Table 7.5: Summary of Kuareno' story

| Plot                 | Conj. | Summary                         | U/M   | Repetition | Index |
|----------------------|-------|---------------------------------|-------|------------|-------|
| 1 <i>Opening</i>     |       | Kuareno's name is K. because    | ʉ̣ ʉ̣ | A B        | (28)  |
| 2 <i>Setting</i>     |       | at first, its name wasn't K.    | ʉ̣ ʉ̣ | A B        | (29a) |
| 3                    |       | its name was Neanpeen           | M     | B C        | (29b) |
| 4                    |       | there were lots of people       | M     |            | (29c) |
| 5 <i>Inciting</i>    | then  | they planted an orange tree     | M ʉ̣  | D          | (30a) |
| 6 <i>incident</i>    |       | a single orange tree            |       | D          | (30b) |
| 7 <i>Climax</i>      | then  | it grew two branches            |       | E          | (31a) |
| 8                    |       | it grew two branches            |       | E          | (31b) |
| 9                    |       | one of the branches             |       | F          | (31c) |
| 10                   |       | its contents and fruit were red |       | G G        | (31d) |
| 11                   |       | one was white                   |       | G          | (31e) |
| 12                   |       | one of the branches was white   |       | F          | (31f) |
| 13 <i>Dénouement</i> | so    | someone called it K.            | M̄ ʉ̣ | A B        | (32a) |
| 14                   | so    | they named it K.                | M̄    | A B        | (32b) |
| 15                   |       | let's change it, not Neanpeen   | ʉ̣ M  | C H        | (32c) |
| 16                   | but   | let's change its name to K.     | M̄ ʉ̣ | A B H      | (32d) |

I have broken the text up according to the plot structure, and discuss each chunk in turn. The identification of different parts of the plot follows the principles and protocols outlined in Dooley & Levinsohn (2001). Parts of each chunk which receive special discussion are indicated in boldface type.

<sup>4</sup>Recall that ‘ʉ̣’ is a consonant-final U-form, or U-form before a consonant cluster. As discussed in §7.3, the default form in such phonotactic environments is the U-form. ‘M̄’ is an M-form before a vowel-initial enclitic. As discussed in Chapter 5, M-forms are obligatory before vowel-initial enclitics.

Line (28) is the Opening of the story. After gathering his thoughts, the narrator provides a short explanation that the text is about the name of *Kuareno'* village.

- (28) Kuareno' – opening: 130823-2 🔊
- ahh, Kuareno? ahh, iin kaan-n=ee Kuareno? na-tuina? ahh*  
*Kuareno? ini kana-n=ee Kuareno? na-tuina?*  
*Kuareno'\U 3SG name-3SG.GEN=3DET Kuareno'\U 3-because*  
 'Umm, Kuareno', its name is Kuareno' because,' 0.00

This opening line is followed by the setting, given as (29) below. The Setting is the part of the story in which the narrator provides background information about the place, time, and participants of the story. In (29) we learn the time this story took place ('long ago, at first') and more about the main participant, the village of *Kuareno'*.

- (29) Kuareno' – Setting: 130823-2 🔊
- a. *na-hunu =t, iin kaan-n=ee ka= Kuareno? =fa.*  
*na-hunu =te ini kana-n=ee ka= Kuareno? =fa*  
*3-first\U =SUB 3SG name-3SG.GEN=3DET NEG= Kuareno'\U =NEG*  
 'Well, at first its name wasn't Kuareno'.' 0.09
- b. *iin kaan-n=ee ahh Neanpeen.*  
*ini kana-n=ee Neanpeen*  
*3SG name-3SG.GEN=3DET Neanpeen\M*  
 'Its name was Neanpeen.' 0.13
- c. *a|n-nao-nao =te, a|n-mui? toogw=ii na-mfau.*  
*n-nao-nao =te, n-mu?i too=ii na-mfau*  
*3-FRD-go =SUB 3-have\M citizen=1DET 3-many*  
 'After a while, it had a lot of residents.' 0.17

In (29a) there is a purely discourse driven U-form; *na-hunu* 'at first; long ago', which is resolved by the following two clauses which describe the situation which held 'long ago'.

In (29) there are also two occurrences of the connector *=te*, glossed as *=SUB* 'subordinator'. This particle marks that the preceding clause is temporally subordinate to the following clause. This particle is always clause final and provides the background which sets the scene for the following clause. The clause preceded by *=te* is the stage on which the following clause takes place.

In (29a) the clause *na-hunu* ‘at first’ is the time of the next clause. In (29c), the clause preceding *=te* is an event (*a/n-nao~nao* ‘it went on’) which preceded the clause following *=te*. Due to the semantics of this connector (background for next clause), verbs before *=te* obligatorily occur in the U-form (resolved by next clause). The use of this enclitic is discussed in more detail in §7.6.2.

After the scene has been set in (29), the narrator introduces the Inciting Incident, given as (30) below. The Inciting Incident of the story is the part of a story in which something first happens and the storyline gets moving. In (30) the inciting incident is introduced by the conjunction *oka =te* ‘after that, then’.<sup>5</sup> It is common for new parts of the plot to be introduced with conjunctions. Conjunctions which do not introduce new parts of the story, such as *=ma* ‘and’, are usually clause final. I call such clause final conjunctions *connectors*. Connectors are discussed in more detail in §7.6.

- (30) Kuareno' – Inciting Incident: 130823-2 🔊
- a. *oka =te, siin n-seen n-ana ?rean?=ees,*  
*oke? =te sini n-sena n-ana ?reno?=esa*  
 after.that 3PL 3-plant\M 3-RES\U orange=one  
 ‘After that, they planted a orange tree,’ 0.22
- b. *u?u mese?, ?rean?=ii u?u mese?*  
*u?u mese? ?reno?=ii u?u mese?*  
 tree single orange=1DET tree single  
 ‘A single one, a single orange tree.’  
 (*lit.* ‘A single tree, the orange was a single tree.’) 0.29

Another common feature of Amarasi discourse found in (30) is repetition. The orange tree is repeated twice as is the fact that it was a single tree. None of these instances of repetition are false starts. Instead, repetition is a common feature of Amarasi discourse and is found with all speakers (including eloquent speakers) in many text genres.

Repetition has already been seen in the Opening (28) and Setting (29) of this text, with three repetitions of *Kuareno?* and three of *iin kaan-n=ee* ‘its name’. Metathesis and repetition interact in Amarasi, as one use of U-forms is to mark one half of a tail-head linkage construction with identical verbs (§7.7).

After the Inciting Incident comes the Climax, the main problem of the story which needs to be solved. The Climax is given as (31) below. As with the Inciting Incident, the Climax is introduced with the conjunction *oke =t* ‘after that, then’.

<sup>5</sup>Historically this conjunction is from *oke?* ‘all, finished’ and the subordinating enclitic *=te*.

As in other parts of the story, the climax also has a large amount of repetition. In fact, there is no clause in (31) which is not repeated in this section.

- (31) Kuareno' – Climax: 130823-2 
- a. *oke =t iin na-tae tae-f nua. aah*  
 oke? =te ini na-tae ta?e-f nua  
 after.that 3SG 3-branch branch-0GEN two  
 'After that, it grew two branches. [murmur of satisfaction]' 0.31
- b. *na-tae tae-f nua,*  
 na-tae ta?e-f nua  
 3-branch branch-0GEN two  
 'It grew two branches.' 0.34
- c. *ees=ii, iin taa?ɔ̄=ees=ii ahh,*  
 esa=ii ini ta?e=esa=ii  
 one=1DET 3SG branch=one=1DET  
 'One of these, one of its branches,' 0.36
- d. *aaf-n=ee me?e, fua-n=ee me?e.*  
 afa-n=ee me?e fua-n=ee me?e  
 content-3SG.GEN=3DET red fruit-3SG.GEN=3DET red  
 'Its contents were red, its fruit was red.' 0.42
- e. *ees=ee muti?. mmh*  
 esa=ee muti?  
 one=3DET white  
 'One was white. [murmur of satisfaction]' 0.45
- f. *taa?ɔ̄=ees=ii muti?.*  
 ta?e=esa=ii muti?  
 branch=one\̄=1DET white  
 'One of the branches was white.' 0.49

There are at least three types of repetition in (31). Clauses (31a) and (31b) are an instance of verbatim repetition: part of the clause is simply repeated word for word. Clause (31d) contains parallelism, in which the same or a similar idea is expressed with non-identical words. In (31d) the parallelism is between *aaf-n=ee* 'its contents' and *fua-n=ee* 'its fruit'. Clauses (31d) and (31e) also contain parallel concepts, in this case *me?e* 'red' and *muti?* 'white'.<sup>6</sup>

<sup>6</sup>The colours of the Indonesian national flag are red and white, and a common term for this flag is *merah putih* 'red white'. The similarity between the colour of the fruit in this story and the Indonesian flag is probably not a coincidence.

Parallelism is an important feature of many languages in Timor, particularly of (but not restricted to) their poetic registers. Fox (1988; 2014) and Grimes et al. (1997: 15ff) discuss the use of parallelism in the languages of this region. I discuss parallelism in Amarasi and Timor in more detail in §7.8 and §8.3.

Clauses (31c)–(31f) present a third kind of repetition, namely chiasmus. Chiasmus typically has the structure ABB'A', where the first and final clauses are parallel to one another and the middle two clauses are parallel to each other. One use of discourse U-forms is to mark the centre of a chiastic structure (§7.9). The chiastic structure of (31c)–(31f) is represented below:

one of the branches was red was white one of the branches

The final part of the story is the Dénouement, the part of the story where the problem introduced in the climax is solved. The dénouement of this story is given in (32). The Climax and/or the Dénouement of the story is usually the most important part of the story, and these sections are often referred to collectively as the Peak.

- (32) Kuareno' – Dénouement: 130823-2 🔊
- a. *ɔʒadi esa n-teek=ee =t n-ak Kuarenoʔ. aah*  
*ɔʒadi esa n-teka=ee =te n-ak Kuarenoʔ*  
 so one 3-call\̄M=3SG.ACC =SUB 3-QUOT Kuareno'\̄U  
 'So someone called it Kuareno'. [murmur of satisfaction] 0.51
- b. *onai =m siin na-kaan-b=ee n-eu:*  
*onai =ma sini na-kana-b=ee n-eu*  
 and.so 3PL 3-name\̄M-TR=3SG.ACC 3-DAT  
 'and so they named it' 0.55
- c. *n-ak "hiit ta-nani? kuan=ii, kaisa? Neanpeen*  
*n-ak hiti ta-nani? kuan=ii kaisa? Neanpeen*  
 3-say 1PI 1PI-move\̄U village=1DET PROH Neanpeen\M  
 'saying "Let's change the village, it shouldn't be Neanpeen' 0.56
- d. *tapi tanai ahh ta-nain?=ee, iin kaan-n=ee Kuarenoʔ.*  
*tapi ta-nani?=ee ini kana-n=ee Kuarenoʔ*  
 but 1PI-move\̄M=3SG.ACC 3SG name-3SG.GEN=3DET K.\̄U  
 'but we'll change it, its name will be Kuareno' 0.59

As in the Inciting Incident and the Climax, the Dénouement in (32) is also introduced by a conjunction; in this case the conjunctions used are *ǰadi* ‘so’ (from Malay *jadi* [ǰadi]) and *onai =m* ‘and so’. Both these conjunctions have the sense of ‘so, consequently’ and tend to be used in logical relations, rather than temporal relations.

Again, there is a large amount of repetition in the Dénouement. Two different verbs for naming occur, *a/n-teek=ee* ‘called it’ and *na-kaan-b=ee* ‘named it’. The verb *ta-nani?* ‘move, change’ also occurs twice. In addition, the final two clauses of the Dénouement form a high-level chiasmus with the first two clauses of the setting in (29). Such a structure is known as a sandwich structure.

In this short text we see three common features of Amarasi discourse. Firstly, Amarasi employs a large amount of repetition of different kinds. Such repetition includes verbatim repetition, parallelism, and chiasmus. Secondly, new parts of the story are typically introduced with clause initial conjunctions such as *oke? =te* ‘after that, then’ or *onai =m* ‘and so’. Thirdly, the particle *=te* is used to background information which is the setting/background of the following clauses. In the following sections we will see the way U-forms and M-forms interact with repetition as well as the connectors *=ma* and *=te*.

## 7.6 Dependent coordination

The most common use of U-forms in discourse is to mark one event/situation as dependent on another event/situation. When the U-form word encodes an event or state, this signals a temporal relation between two events with the U-form event beginning prior to and leading into the next event. The typical structure of dependent coordination is given in (33) below.

$$(33) \text{ event}_1 \setminus \text{U} \left( \begin{array}{l} =ma \\ =te \end{array} \right) \text{ event}_2 (\setminus \text{M})$$

More than half (261/423) of all discourse-driven U-forms in my corpus are instances of dependent coordination. Most examples of dependent coordination involve either of the connectors *=ma* ‘and’ or *=te* SET ‘when, as’. One of these connectors occurs in 86% (225/261) of all examples in my corpus. I discuss each in turn, followed in §7.6.3 by dependent coordination without any connector.

Each of the connectors *=ma* and *=te* has four allomorphs. Firstly, after consonants these connectors usually (though not obligatorily) take an initial /a/, thus *=ama* and *=ate*. As discussed in §3.7.3 and §5.1 the allomorphs of these enclitics

with initial /a/ are optionally treated as vowel-initial and thus trigger metathesis on consonant-final hosts.

Secondly, it is common for the final vowel of these connectors to be deleted, thus =*m* and =*t*, or after consonants =*am* and =*at*. The allomorphy of these connectors is summarised in (34) below. (See §3.7.3 for more details.)

## (34) Connector allomorphy

|             |   |              |   |             |      |
|-------------|---|--------------|---|-------------|------|
| = <i>te</i> | → | = <i>te</i>  | ~ | = <i>t</i>  | /V#_ |
|             | → | = <i>ate</i> | ~ | = <i>at</i> | /C#_ |
| = <i>ma</i> | → | = <i>ma</i>  | ~ | = <i>m</i>  | /V#_ |
|             | → | = <i>ama</i> | ~ | = <i>am</i> | /C#_ |

7.6.1 Dependent coordination with =*ma* ‘and’

When the connector =*ma* ‘and’ occurs after a U-form, it signals that this event precedes the next event. This often also implies that the first event caused the second event. The event encoded by the U-form is resolved by the following event. This is illustrated in (35) below. There are 118 examples of dependent coordination with the connector =*ma* in my corpus.

(35)  $\text{event}_1 \setminus \text{U} =ma \longrightarrow \text{event}_2 \setminus \text{M}$ 

A U-form followed by =*ma* ‘and’ is viewed as a separate event discrete from the next event rather than both events being viewed as a single complex whole. This contrasts with M-forms followed by =*ma* ‘and’, in which the events encoded by each verb are identical. Four examples of a U-form and the connector =*ma* are given in (36)–(39) below. In each example the U-form describes an event which preceded and led to the event encoded by the verb following =*ma*. The resolving event is that following the U-form.

- (36) *iin aam-f=ii esa n-renu =ma n-hain re? nopu.*  
*ini ama-f=ii esa n-renu =ma n-hani re? nopu*  
 3SG father-GEN=1DET COP 3-order\U =and 3-dig\M TOP hole  
 ‘It was his<sub>i</sub> father who gave the order and (he<sub>i</sub>) dug the grave.’ 130928-1,  
 1.54 🔊

- (37) *m-ak hai nua =kai m-taikobi =m hai m-maet oke?*  
*m-ak hai nua =kai m-taikobi =ma hai m-mate oke?*  
 1PX/2-say 1PX two 1PX.ACC 1PX/2-fall\U =and 1PX 1PX/2-die\M all  
 ‘So we two will fall down and (then) both die.’ 130909-6, 0.39 🔊



- (38) *au maeb=ees=ii, ʔ-toko =ma ʔ-tui sina =m au ʔ-kaububu?*  
 au mabe-ʔ=esa=ii ʔ-toko =ma ʔ-tui sina =m au ʔ-kaububu?  
 1SG time=one=1DET 1SG-sit\U =and 1SG-write 3PL =and 1SG 1SG-gather\Ū  
*siin eta=n neʔ suurt=ee =m*  
*sina eta=n neʔ suurt=ee =ma*  
 3PL IPFV.LOC=PL TOP paper=3DET =and  
 ‘A few nights ago I sat down and (then) wrote them down and collected  
 them in the book and ...’ 130909-5, 0.28 🔊
- (39) *a/n-moʔe =ma n-poodʒ=ena n-bi metoʔ.*  
 n-moʔe =ma n-poi=ena n-bi metoʔ  
 3-make\U =and 3-exit\̄M=INCEP 3-RL.LOC dry  
 ‘he created and (then) went out onto dry land.’ 120715-4, 0.45 🔊

When the event followed by =*ma* temporally precedes the next event, it is not grammatical for the first event to be in the M-form. This is shown in (36′) and (39′) below, each of which is a manipulated version of the equivalent examples (without primes) above with the only difference being the use of an M-form verb instead of a U-form.

- (36′) \* *iin aam-f=ii esa n-reun =ma n-hain reʔ nopu*  
 ini ama-f=ii esa n-renu =ma n-hani reʔ nopu  
 3SG father-GEN=1DET COP 3-order\M =and 3-dig\M TOP hole  
 ‘(It was his<sub>i</sub> father who gave the order and (he<sub>i</sub>) dug the grave.)’ elicit.  
 09/02/16 p.9
- (39′) \* *a/n-moeʔ =ma n-poodʒ=ena n-bi metoʔ*  
 n-moʔe =ma n-poi=ena n-bi metoʔ  
 3-make\M =and 3-exit\̄M=INCEP 3-RL.LOC dry  
 ‘(he made and (then) went out onto dry land.)’ elicit. 13/02/16 p.16

It is possible for an M-form to occur before =*ma*. When this is the case, the words connected by =*ma* encode the same event, as discussed in §7.6.1.1 below. The ungrammaticality of examples (36′) and (39′) is thus explained by the impossibility of each of the verbs encoding an identical event.

### 7.6.1.1 M-forms before =*ma* ‘and’

Examples (36′) and (39′) can be contrasted with examples in which an M-form verb occurs before =*ma* and both verbs describe the same event, as illustrated in (40) below.

- (40)
- event [VERB\M =ma VERB]
- 

An example of two verbs connected by =ma describing a single event is given in (41) below. In this example the event encoded by the verb following =ma anaphorically refers to the same event encoded by the verb preceding =ma.

- (41) *fee\_mnais?=ee na-suun =ma n-moa? on re? ia.*  
*fee\_mnasi?=ee na-suna =ma n-mo?e on re? ia*  
*wife\_old=3DET 3-spin.thread\M =and 3-do like TOP 1DEM*  
 ‘The old woman spun thread doing it like this.’ 120715-3, 0.14 🔊

This pattern is particularly common in poetic parallelism, in which two semantically parallel verbs are used to describe a single event. An example is given in (42) below, in which the verbs on either side of the connector =ma are near-synonyms used to describe a single event. Poetic parallelism is discussed in more detail in §7.8.

- (42) *mu-heun =ma mu-tiis paah\_pina-n*  
*mu-henu =ma mu-tisi paha\_pina-n*  
*2SG-fill\M =and 2SG\TR-pour country\_below-3SG.GEN*  
 ‘Fill [doublet] the earth.’ 160326, 1.50 🔊

### 7.6.1.2 Large numerals

One specific kind of dependent coordination with =ma ‘and’ involves large numbers. In this case numerals before the connector =ma obligatorily occur in the U-form. Three examples are given in (43)–(45) below.

- (43) *bo? fanu =m teun*  
*bo? fanu =ma tenu*  
*ten eight\U =and three\M*  
 ‘eighty-three’ (83) 🔊
- (44) *nifun nima =m natun hitu =m bo? nee =m faun*  
*nifun nima =ma natun hitu =ma bo? nee =ma faun*  
*thousand five\U =and hundred seven\U =and ten six and eight\M*  
 ‘five thousand seven hundred and sixty-eight’ (5,768) 🔊

- (45) *nifun bo? hitu =m niim*  
*nifun bo? hitu =ma nima*  
 thousand ten seven\U =and five\M  
 ‘Seventy-five thousand’ (75,000) 130823-5, 0.42 

In such instances the U-form numeral is not an event which occurs chronologically prior to the following numerals, but instead the U-form signals that the numeral is not complete. The final numeral – an M-form in each of the examples above – resolves all previous U-forms and signals completion of the numeral.

### 7.6.2 Dependent coordination with =te ‘SET’

The connector =te marks a background event which sets the scene for the following event. The clause preceded by =te is the stage on which the following event takes place. The event or situation followed by =te begins before the second event and is usually ongoing when the second event begins. This is illustrated in (46) below in which the arrows represent the temporal duration of an event. There are 105 examples of dependent coordination with a U-form and the connector =te in my corpus.

- (46) 
$$\begin{array}{c} \text{event}_2(\backslash M) \\ \xrightarrow{\hspace{10em}} \\ \text{event}_1\backslash U =te \\ \xrightarrow{\hspace{10em}} \end{array}$$

Two examples are given in (47) and (50) below. In example (47) the U-form verb *n-mate* ‘dies, is dead’ encodes a state which must happen before the M-form verb *t-suub* ‘bury’ can be carried out. Likewise, in example (48) the U-form *mu-hini* ‘know’ encodes a state which must hold if the event encoded by the M-form final serial verb construction *m-suir m-aan* ‘heal’ is to occur.

- (47) *neh, dʒadi iin n-mate =te t-suub=ee*  
*dʒadi ini n-mate =te t-suba=ee*  
 so 3SG 3-die\U =SUB 1PI-bury\M=3SG.ACC  
*on pani-n neefgw=ee?*  
*on pani-n nefo=ee*  
 IRR.LOC across-3SG.GEN lake=3DET  
 ‘So, when he’s dead we bury him beside the lake?’ 130913-1, 0.00 

- (48) *reko papa =m hoo mu-hini =t a/m-turan he m-suir*  
 reko papa =ma hoo mu-hini =te m-turan he m-suri  
 good dad =and 2SG 2SG-know\U =SUB 1PX/2-help IRR 1PX/2-heal\M  
*m-aan =kau hee.*  
*m-ana =kau hee*  
 1PX/2-RES\M =1SG.ACC hey  
 ‘It’s good, dad, if you know how to help heal me.’ 120923-2, 5.25 🗣️

Another two examples are given in (48) and (49) below. In example (49) the U-form verb *?-toko* ‘sit’ describes a state which held when the M-form verb *n-aun* ‘disturb’ occurred. Similarly, in example (50) the U-form verb *n-toko* ‘sits’ encodes an event which will be ongoing at the time of the next event.

- (49) *a/?-tok~toko =t n-eu, kmiiɟ=ii n-aun =kaagw=een.*  
 ?-tok~toko =te n-eu kmii=ii n-anu =kau=ena  
 1SG-INTNS~sit\U =SUB 3-DAT urine=1DET 3-disturb\M =1SG.ACC=INCEP  
 ‘I was sitting there and needed to relieve myself.’  
 (*lit.* ‘While sitting, the urine disturbed me.’) 130825-6, 21.34 🗣️
- (50) *iin n-toko =t, iin ofa n-reis n-ain are? haef=ein msa?.*  
 ini n-toko =te ini ofa n-resi n-ani are? haef=eni msa?  
 3SG 3-sit\U =SUB 3SG sure 3-plan 3-first\M each messenger=PL even  
 ‘He’ll sit and surely even plan the messengers beforehand.’ 130913-1,  
 2.43 🗣️

There is some overlap in the use of U-forms before the connectors *=te* ‘SET’ and *=ma* ‘and’. For instance, example (38) on page 349 has the verb *√toko* ‘sit’ as the U-form before *=ma*, much like examples (49) and (50) above in which *√toko* ‘sit’ precedes *=te*. While all three examples encode an event which happened while sitting, in (38) with *=ma* there is more emphasis on the initial action of the subject assuming a sitting position. In examples (49) and (50) on the other hand, the initial action of sitting down is less relevant and the emphasis is on the sitting as an ongoing state.

It is not uncommon for the event/state preceded by *=te* to refer to a specific time. Two examples are given in (51) and (52) below. In each of these examples the U-form verb encodes the time of day at which the event encoded by the next verb takes place.

- (51) *Mere, airoo, Mere, maans=ee* *n-mabe* =*t* *hoo* *mu-kpesa?*  
 Mere airoo Mere manas=ee n-mabe =te hoo mu-kpesa?  
 Mary oh Mary sun=3DET 3-afternoon\U =SUB 2SG 2SG-sift\U  
 ‘Mary, oh Mary, it’s afternoon while you’re sifting.’ 130825-6, 4.51 🔊
- (52) *nmeu* *n-fini* =*t*, *n-aena* *n-bi* *aat* *dees=ii*, =*m* *n-ak*  
 nmeu\_n-fini =te n-aena n-bi ata desa=ii =ma n-ak  
 early.morning\U =SUB 3-run\U 3-RL.LOC up\M village=1DET =and 3-say  
 ‘Early in the morning he ran up to the village (head) and said’ 130825-6,  
 7.28 🔊

Another two examples are given in (53) and (54) below. In each of these examples the U-form before =*te* is a cardinal numeral (§6.5.1) and each describes the exact day or time at which the next event occurs.

- (53) *neno* *nima* =*te* *hai* *m-piir* *bupati.*  
 neno nima =te hai m-piri bupati  
 day five\U =SUB 1PX 1PX/2-choose\M regent  
 ‘In five days we’ll elect a (new) regent.’ 130902-1, 4.32 🔊
- (54) *n-reuk* *fanu* =*te*, *pa?* *Charles, pa? Graims*  
 n-reku fanu =te pa? Charles pa? Graims  
 3-hit eight\U =SUB Mr. Charles Mr. Grimes  
*a/n-koen=oo-n* *neem.*  
 n-koen=oo-n nema  
 3-depart=REFL-3SG.GEN 3\come\M  
 ‘As it struck 8:00 Mr. Charles, Mr. Grimes came.’ 130920-1, 0.51 🔊

The connector =*te* almost always occurs after U-forms and it is usually ungrammatical for =*te* or its allomorph =*ate* (used after consonants) to occur after a word in the M-form. This ungrammaticality is explained by the fact that =*te* explicitly marks an event as only relevant in the context of another event. Thus, it must co-occur with a U-form which marks an event as resolved by a following event. Two examples are given in (53’) and (54’) below.

- (53’) \* *neno niim =te hai m-piir bupati*  
 neno nima =te hai m-piri bupati  
 day five\M =SUB 1PX 1PX/2-choose\M regent  
 ‘(In five days we’ll elect a (new) regent.)’ elicited. 22/02/16 p.21

- (54') \* *n-reuk faun =ate pa? Charles pa? Graims*  
*n-reku fanu =te pa? Charles pa? Graims*  
 3-hit eight\M =SUB Mr. Charles Mr. Grimes  
*a|n-koen=oo-n neem*  
*n-koen=oo-n nema*  
 3-depart=REFL-3SG.GEN 3\come  
 '(As it struck 8:00 Mr. Charles, Mr. Grimes came.)' elicit. 13/02/16  
 p. 15

While it would be possible to analyse this as a case of morphemically conditioned metathesis (§2.2.2), this analysis would ignore the generalisation that U-forms are used mark events resolved by a following event. The inability of *=te* to occur with an M-form is due to *=te* requiring another event for which it sets the stage.<sup>7</sup>

### 7.6.2.1 *rari =te* 'after that'

One verb which frequently occurs with *=te* in dependent coordination is *rari* 'finish'. Such instances of *rari =te* are examples of a reduced adverbial clause (Lehmann 1988: 211). Two examples are given in (55) and (56) below. In each example the event preceding *rari =te* was completed before the beginning of the event following *rari =te*.

- (55) Organising a wedding reception: 130902-1 
- a. *oke? =te, hai m-?ator, aʃara, n-eu re?, ahh,*  
*oke? =te hai m-?ator aʃara n-eu re?*  
 after.that 1PX 1PX/2-arrange event 3-DAT TOP  
*oras toup tamu, resepsi*  
*oras topu tamu resepsi*  
 time receive guest reception  
 'After that we arranged an event, a time to receive guests, a reception.'  
 0.39

<sup>7</sup>Some evidence in favour of analysing this as morphemically conditioned metathesis may come from the universal occurrence in my corpus of verbal U-forms before the enclitic *=ha* 'just, only'. (Though this has not yet been tested under elicitation.) While morphemically conditioned metathesis may be able to account for the use of U-forms before *=te* 'SUB' and *=ha* 'just, only', it cannot account for the use of both U-forms and M-forms before *=ma* (§7.6.1) or examples in which no connector occurs (§7.6.3). It also cannot account for the use of U-forms in conversation (§7.10).

- b. *hai mi-rari =te,*  
 1PX 1PX/2PL-finish\U =SUB  
 ‘When we finished that,’ 0.48
- c. *hai m-, m-fee mainuan n-eu ana?apreent =ama are?*  
 1PX 1PX/2-give opportunity 3-DAT official =and every  
*saksii mahonit he n-fee, ahh, fainekat.*  
 witness elder IRR 3-give advice  
 ‘We gave an opportunity to the government officials and each of the  
 witnesses and clan elders to give advice.’ 0.51
- (56) Organising clothes to go to a wedding: 130825-6 🔊
- a. *?-istarika =m,*  
*?-istarika =ma*  
 1SG-iron\U =and  
 ‘I ironed (my pants) and,’ 10.16
- b. *u-rari =te, ?-aena ?-bi nahen Jes Ora? nee,*  
*u-rari =te ?-aena ?-bi nahen Jes Ora? nee*  
 1SG-finish\U =SUB 1SG-run\U 1SG-RL.LOC down Jes Ora’ 3DEM  
 ‘having finished I ran down there to Jes Ora.’ 10.18

When *rari* co-occurs with *=te*, it does not have to take agreement prefixes. Such instances of *rari =te* are often best translated as ‘after that’. There are three such examples in my corpus. Two of these are given in (57) and (58) below.

In example (57) *rari =te* ‘finish’ serves to transition between two episodes of the story. It marks that the penultimate event of the wedding reception had finished (*na-prir~rira?* ‘dance’) before the final event took place (*n-ma-taeb* ‘shake hands’), and the main characters of the story left the wedding reception.

- (57) Attending a wedding reception: 130902-1 🔊
- a. *nai? Owen a/msa? n-ok na-bsoo? na-prira? kuu-n.*  
*nai? Owen msa? n-oka na-bso?o na-prira? kuu-n*  
 Mr. Owen also 3-with\M 3-dance\M 3-dance\U self-3SG.GEN  
 ‘Owen also joined in the dancing by himself (i.e. without me).’ 3.23
- b. *na-prir~rira? mhh.*  
 3-INTNS~dance.with.arms\U  
 ‘He danced and danced.’ 3.26

7 Discourse-driven metathesis

- c. *ahh, rari =te, n-ma-taeb n-ok ahh baroit=n=eni*  
*rari =te n-ma-tabe n-oka baroti=n=eni*  
 finish\U =SUB 3-RECP-greet\M 3-with\M bride/groom=PL=PL  
*=ma hai m-tebi m-fain iim.*  
*=ma hai m-tebi m-fani ima*  
*=and 1PX 1PX/2-turn\U 1PX/2-return\M 1PX/2PL\come\M*  
 ‘After that he shook hands with each of the bride and groom and we  
 turned and came back.’ 3.34

Example (58) below shows that such uses of *rari =te* have become semantically bleached, with the meaning ‘finish’ giving way to a more general ‘after that’. In example (58) the event preceding the reduced adverbial clause is *mi-sopu m-rair* ‘finished completing’, in which the last verb of the serial verb construction has the same root as that of *rari =te*.



- (58) Reading books of the Bible: 130921-1 🗣️
- a. *hai mi-sopu m-rair Roma, ees nean haa-?=ii*  
 1PX 1PX/2PL-complete 1PX/2-finish Romans COP day four-ORD=1DET  
 ‘We completed Romans, it was on Thursday.’ 0.43
- b. *rari =t, nean niim-?=ii,*  
*rari =te neno nima-?=ii*  
 finish\U =SUB day five-ORD=1DET  
 ‘After that, on Friday,’ 0.47
- c. *hai mi-koon-b=ee n-ok nai? Yohanis iin surat*  
*hai mi-kono-b=ee n-oka nai? Yohanis ini surat*  
 1PX 1PX/2PL-keep.on\M-TR=3SG.ACC 3-with\M Mr. John 3SG paper  
*re?, a-hunu-t*  
*re? a-hunu-t*  
 REL NML-first-NML  
 ‘we kept going with John’s first book (1 John).’ 0.50

There are only three examples of *rari =te* without an agreement prefix found in my corpus. However, a search of the Amarasi Bible yielded 2,733 instances of *rari* without an agreement prefix preceding *=te*. All but two of these are orthographic <*rari*> or <*Rari*> with *te* reduced to a single consonant, as in (58) above. The Amarasi Bible contains 27 instances of <-*rari*> with an agreement prefix followed by full <*te*>.



## 7.6.3 Dependent coordination with no connector

There are also a handful of examples in my corpus of dependent coordination in which neither of the connectors =*ma* ‘and’ or =*te* ‘SET’ occur. In examples (59) and (60) the event encoded by the U-form chronologically precedes the next event.

- (59) *usi n-romi uma ?-nao.*  
king 3-like\U 1/2SG\come\U 1SG-go  
‘The king liked (that), so I came back.’ 130907-3, 5.13 
- (60) *n-aka n-manini mes na-seedz=oo-n*  
n-aka n-manini mes na-see=oo-n  
3-say 3-fever\U but 3-excuse\M=REFL-3SG.GEN  
*re? ia ro n-tuup=een.*  
re? ia ro n-tupa=ena  
REL 1DEM must 3-sleep\M=INCEP  
‘He said he had fever but excused himself to sleep.’ 120923-1, 4.18 

In example (61a) below the serial verb construction *ta-hiin t-ana* ‘figure out, get to know’ introduces a list of different information which resolves this U-form. This usage is not dissimilar to the use of U-forms in large numerals (§7.6.1.2).

- (61) The settling of Koro'oto hamlet: 160326 
- a. *siin neem na-tua Koor?oot ees re? oras mee*  
sini neem na-tua Koor?oto esa re? oras mee  
3PL 3\come 3-settle Koro'oto\M COP REL time where  
*ka= ta-hiin t-ana =f.*  
*ka= ta-hini t-ana =f.*  
NEG= 0-know 0-RES\U =NEG  
‘They came and settled in Koro'oto, it was at a time which hasn't been figured out.’ 5.37
- b. *bian n-ak, of fuunn=ees re? kira-kira abat ke-?empat blas.*  
some 3-say sure month=one REL around century ORD-four ten  
‘Some say/think it was a month in the fourteenth century.’ 5.45
- c. *bian n-ak, ma-tu<?>i n-bi balai desa =te n-ak,*  
some 3-say PROP-write <PROP> 3-RL.LOC office village =SUB 3-say  
*kira-kira abat ke-delapan blas.*  
around century ORD-eight ten  
‘Some say/think, (as) is written in the village office, that it was around the eighteenth century.’ 5.45

The introduction of a list is particularly common with the U-form of the plural enclitic =eni (§5.6). In such cases, =eni occurs attached to a nominal and the list enumerates the members of that nominal. Such examples represent just under half (7/18) of all U-forms of the plural enclitic =eni in my corpus.

Three examples are given in (62)–(64) below. In each case the contents of the list resolve the U-form. In example (62) the form =eni is attached to *a-resa-t* ‘reader’ and introduces a list of proper names: the people who were the readers.

- (62) Reading books of the Bible: 130920-1 
- a. *ai? na-taan a-rees-t=eni, ahh*  
*ai? na-tana a-resa-t=eni*  
 or 3-ask\M NML-read-NML=PL\U  
 ‘or the readers were asked’ 1.32
- b. *bi Yane, ain Lince, aam Ferdi*  
 Ms. Yane mother Lince father Ferdi  
 ‘Yane, Lince (and) Ferdi (were the readers).’ 1.36

Similarly, in (63) the form =eni introduces a list of people who correspond to the head nominal *nuuk tuaf* ‘people in grief’. In this example only the main member of this group (*Fanu*) is introduced with a proper name while the other members are mentioned by their relationship to him.

- (63) The death of Nahor Bani: 130928-1 
- a. *nuuk tuaf=eni nai? Fanu n-ok are? iin tata-f,*  
*nuka tuaf=eni nai? Fanu n-oka are? ini tata-f*  
 grief person=PL\U Mr. Fanu 3-with\M each 3SG eSi-GEN  
 ‘The ones in grief, Fanu and each of his older siblings,’ 2.05
- b. *es-esa =t n-ok iin fee iin mone*  
 INTNS~one\U =SUB 3-with\M 3SG wife 3SG husband  
 ‘each with their wife or husband.’ 2.09

In example (64) =eni introduces a list of (two) names but in this instance these names are not people but rather members of the group *kaan aku-f* ‘special name’.

- (64) *siin nai? Bain mone kusus,*  
*sini nai? Bani mone kusus*  
 3PL Mr. Bani\M male exclusive  
*siin kaan auk-k=eni* *bisa, Mea ai? Tutun.*  
*sini kana aku-k=eni* *bisa Mea ai? Tutun*  
 3PL name\M praise.name-3PL/1GEN=PL\U can Mea or Tutun  
 ‘Members of the Bani clan classified as male can exclusively have the praise  
 names Mea or Tutun.’<sup>8</sup> 160326, 18.26 🔊

In summary, dependent coordination can also occur when neither of the connectors =*ma* or =*te* occur. One specific kind of dependent coordination without a connector is the use of the U-form =*eni* ‘PL’ to introduce a list. In such instances the list resolves the plural marker.

#### 7.6.4 Place names

Native place names participate in discourse-driven metathesis. As with verbs, the default form of vowel-final place names in Amarasi is the M-form. This includes certain locational nouns such as *pina* → *piin* ‘below’, and *fafo* → *faof* ‘above’. Consonant-final place names, such as *Kopan* ‘Kupang’ and *Kuareno?* (see §7.5) occur in the U-form (glossed \ŭ) except before determiners. However, place names which are vowel final occur by default in the M-form.

Three textual examples of a simple declarative clause with a place name with a vowel-final root are given in (65)–(67) below. In each example the place name occurs in the M-form.

- (65) a.  $\alpha$ : *Bein Masneno? umi mee?*  
*Beni Masneno? umi mee*  
 Benny Masneno’ house where?  
 ‘Where is Benny Masneno’s house?’ 130825-8, 1.00 🔊
- b.  $\beta$ : *Sonraen.*  
*Sonrane*  
*Sonraen\M*  
 ‘Sonraen.’

<sup>8</sup>In Amarasi society the classification of households as *mone* ‘male’ or *feto* ‘female’ refers to their social relationship to one another rather than biological gender. See §8.3 for discussion of the complementary pair *feto-mone* ‘female-male’ as well as the connection between metathesis and the Amarasi division of the world into parallel and complementary pairs.

- (66) *paʔ ʔnaak– Inabui ʔnaak aanʔ=ii n-bi Oekbiit.*  
*paʔ Inabuy ʔnaka anaʔ=ii n-bi Oekbiti*  
 Mr. Inabuy head small=1DET 3-RL.LOC Oekbiti\M  
 ‘Mr. Inabuy was the deputy leader in Oekbiti.’ 130907-3, 5.31 🔊
- (67) *ees reʔ Koorʔoot na-heun bare~bare bian.*  
*esa reʔ Koorʔoto na-henu bare~bare bian*  
 COP REL Koro'oto\M 3-fill FRD~place other  
 ‘Koro'oto was the one which filled other places.’ 160326, 17.41 🔊

The only environment in which place names are attested in the U-form in my corpus is before either of the connectors =*ma* or =*te* in a dependent coordination construction. In such examples it is not the place name itself which is unresolved, but rather the entire clause within which the place name occurs, with the following clause adding additional information. Three examples are given in (68)–(70) below. While *Sonraen* occurs in the M-form in (65), when before the connector =*te* in (68) below it occurs in the U-form.

- (68) *iin n-tee Sonrane =t, maans=ee n-peeʔ.*  
*ini n-tea Sonrane =te manas=ee n-peʔe*  
 3SG 3-arrive Sonraen\U =SUB sun=3DET 3-break\M  
 ‘When s/he arrived at Sonraen, it was sunrise’ 130914-3, 0.23 🔊

Similarly, in (66) above *Oekbiit* occurs in the M-form, while in (69) below it is before =*ma* and occurs in the U-form.

- (69) *nhh ʔ-nao =ma ʔ-nao ʔ-bi kantoor na Oekbiti =ma,*  
*ʔ-nao =ma ʔ-nao ʔ-bi kantoor na Oekbiti =ma,*  
 1SG-go =and 1SG-go 1SG-RL.LOC office well Oekbiti\U =and  
 ‘And so I went to the office (of), well, Oekbiti and ...’ 130907-3, 4.41 🔊

Likewise, the name *Koorʔoot* is in the M-form in (67) above, but before the connector =*te* in (70a) below it occurs in the U-form *Koorʔoto*. Example (70b) also has an M-form of this place name.

- (70) Praying for rain: 160326, 16.14 🔊
- a. *karu n-boefanu =m n-ak uurn=ii n-mouf n-eu =ha,*  
*karu n-boefanu =ma n-ak uran=ii n-mofu n-eu =ha*  
 if 3-pray.fervently\U =and 3-say rain=1DET 3-fall\M 3-DAT =only

*n-eu =ha re? Koor?oto =te,*  
*n-eu =ha re? Koor?oto =te*  
 3-DAT =only TOP Koro'oto\U =SUB

‘If they prayed fervently for the rain to fall just on Koro'oto,’

- b. *uurn=ii n-eu =ha re? Koor?oot. kuan bian ka= na-peni=f.*  
*uran=ii n-eu =ha re? Koor?oto kuan bian ka= na-peni=fa*  
 rain=1DET 3-DAT =only TOP Koro'oto\M village other NEG= 3-get=NEG

‘the rain (fell) only on Koro'oto. Other villages wouldn't get any.’

U-forms of place names likely occur in other environments where discourse-driven U-forms occur, such as tail-head linkage (§7.7) and question-answer pairs (§7.10). However, in my current corpus I only have clear examples in dependent coordination.

## 7.7 Tail-Head linkage

Another use of U-forms in Amarasi discourse is in tail-head linkage. Tail-head linkage is a repetition structure for slowing down the rate of new information, “in which the last sentence of one paragraph cross-references to the first sentence of the following paragraph” (Longacre 1983: 9). Tail-head linkage can also link clauses in sentences. A simple example of tail-head linkage in English is given in (71) below.

- (71) a. *I **arrived** home.*  
 b. *When I **arrived**, I went straight to the fridge.*

Tail-head linkage in Amarasi typically consists of repetition of a single verb, with the second instance of the verb introducing an event subsequent to the event encoded by both verbs, or introducing extra information about the way in which that event occurred. One of the repeated verbs is in the U-form and the other repeated verb is in the M-form. The new event introduced resolves the U-form half of the tail-head linkage construction.

Tail-head linkage in Amarasi is a kind of dependent coordination (§7.6) structure with repetition of the first event. The two typical structures of tail-head linkage in Amarasi are given in (72) and (73) below. The first instance of the word encoding event<sub>1</sub> is the tail and the second instance of this word is the head.

- (72) 

|                       |                       |                            |                    |
|-----------------------|-----------------------|----------------------------|--------------------|
| event <sub>1</sub> \M | event <sub>1</sub> \U | (= <i>ma</i> / <i>te</i> ) | event <sub>2</sub> |
|-----------------------|-----------------------|----------------------------|--------------------|
-

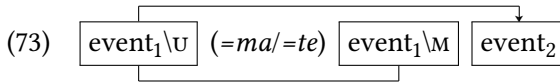

Except in highly restricted examples it is not usually grammatical for both verbs encoding the first event to take the same form of metathesis.<sup>9</sup> If the tail is in the U-form, the head must be in the M-form. If the tail is in the M-form, the head must be in the U-form. The tail and head form a complementary and mutually dependent pair.

There are 72 instances of tail-head linkage with a U-form in my corpus – 17% (72/423) of all discourse-driven U-forms in my corpus. The M-form half of a tail-head linkage construction is often in the M-form due to a vowel-initial enclitic (Chapters 5 and §7.4) or as the first member of a serial verb construction (§6.7, §7.2).

### 7.7.1 M-form tail and U-form head

There are 26 instances of tail-head linkage in my corpus in which the tail is in the M-form and the head in the U-form. In most instances the head is followed by one of the connectors *=ma* ‘and’ or *=te* SET ‘when, as’.

The structure of these tail-head linkage constructions is given in (74) below. The tail occurs in the M-form followed by the head in the U-form. This introduces a second event which resolves the previous U-form.

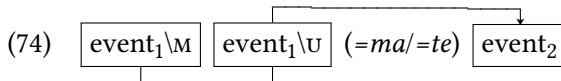



In about one quarter (7/26) of these examples the tail occurs at the point where the plot structure shifts from background information to the storyline, in or after the Setting part of a story, with the U-form head occurring in the Inciting Incident, which then leads to the Climax. If we examine only the low-level structure of the immediate sentences or clauses such U-forms are usually resolved fairly quickly. However, at the higher level of the plot structure of a narrative, the problems introduced by such U-forms are often not resolved until the Dénouement of the story.

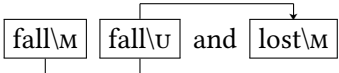

One example is given in (75) below. In this instance the M-form tail occurs in the first part of the Inciting Incident of the narrative. At a low level the U-form *n-mofu* ‘fall’ in (75c) is resolved by the following event which it causes, *na-mneuk*

<sup>9</sup>When both verbs are followed by a vowel-initial enclitic, both may be in the M-form.

‘lost’. However, at a higher level of the discourse this entire incident is not resolved until several clauses later in the Dénouement when the problem introduced by (75) is resolved.

- (75) Going to a party – Inciting Incident: 
- a. *oras hai m-nao =te,*  
time 1PX 1PX/2-go =SUB  
‘While we were going,’
- b. *nai? Owen ina ?piur?=ee n-mouf,*  
nai? Owen ina ?piru?=ee n-mofu  
Mr. Owen 3SG cloth=3DET 3-fall\M  
‘Owen’s handkerchief fell,’
- c. *n-mofu =m na-mneuk.*  
n-mofu =ma na-mneku  
3-fall\U =and 3-lose\M  
‘it fell and got lost’ 130902-1, 1.43 

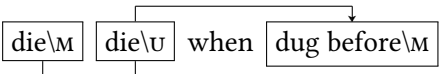
Another example is given in (76) below, which consists of the first three clauses of a story. The first clause in (76a) is the Setting of the story with the M-form verb *n-maet* ‘dies’. This verb is then repeated as a U-form in (76b) to introduce the Inciting Incident in (76c). At a low level, the U-form verb *n-mate* in (76b) is resolved by the event in (76c). However, at a higher level, the chain of events introduced by this U-form is not resolved until much later in this story.

- (76) Nahor Bani’s death:  130928-1 
- a. *nenō ia aam Nahor Bani iin n-maet.*  
nenō ia ama Nahor Bani ini n-mate  
day 1DEM father Nahor Bani 3SG 3-die\M  
‘Today father Nahor Bani died.’ 0.02
- b. *oras iin n-mate =te,*  
time 3SG 3-die\U =SUB  
‘When he died,’ 0.06
- c. *iin aan moonč?=ees kaan-n=ee nai?, Fanu,*  
ini anah mone=esa kana-n=ee nai? Fanu  
3SG child male=one name-3SG.GEN=3DET Mr. Fanu

7 Discourse-driven metathesis

*a|n-hain n-ain nopu.*  
*n-hani n-ani nopu*  
 3-dig\M 3-before\M hole

‘One of his sons, called Fanu, had dug the grave beforehand.’ 0.11

Another example is given in (77) below. In this example (77a) is the final part of the Setting: the narrator is relaxing in his hotel room. The Setting ends with the M-form *?-iingw=een* ‘drank’. As with the previous two examples, this verb occurs as a U-form in the following clause (77b) to introduce the Inciting Incident: the narrator enters the bathroom.

(77) Exploring a hotel room:

130825-8 

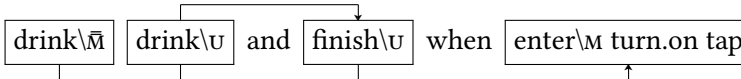

a. *?-took ?-oka bruuk=ii =m ?-ait biir kalen*  
*?-toko ?-oka bruuk=ii =ma ?-aiti biir kalen*  
 1SG-sit\M 1SG-with\U pants=1DET =and 1SG-pick.up\M beer can  
 =*siin* =*m* *?-iingw=een*  
 =*sini* =*ma* *?-inu=ena*  
 =ASSOC.PL =and 1SG-drink\M=INCEP

‘I sat down in the pants, picked up some beer cans and drank.’ 1.06

b. *?-inu =m u-rari =t, a|?-taam ?-ai kraan=ii,*  
*?-inu =ma u-rari =te ?-taam ?-ai kraan=ii*  
 1SG-drink\U =and 1SG-finish\U =SUB 1SG-enter\M 1SG-push tap=1DET

‘I drank and when I finished, I went in and turned on the tap,’ 1.10

c. *mu-hiin he oe mapuut?=ee es mee =m oe*  
*mu-hini he oe maputu?=ee es mee =ma oe*  
 2SG-know\M IRR water hot=3DET IPFV.LOC where =and water  
*mainiikn=ee es mee?*  
*mainikin=ee es mee*  
 cold=3DET IPFV.LOC where

‘Do you know where the hot water is and where the cold water is?’  
 (implied: I didn’t know) 1.13

While about a quarter of tail-head linkages with a U-form head are used to introduce the Climax part of the plot, others are simply used to introduce some extra information. One such example is given in (78) below. In this example the





(79) Growing old together: old\M old\U when stare\U 130909-6, 2.20 ▶▶

- a. *haa ja. on re? naan, ta-mnaas~~g~~=een =t,*  
*haa ja on re? naan ta-mnasi=ena =te*  
 hey yes like REL2DEM 1PI-old\M=INCEP =SUB

‘What’s that? Yes. That’s how it is. When we grow old,’

- b. *au ?-ak ai? eh ta-mnasi ai? ia =t, of ai? ta-smeru?*  
 1SG 1SG-say or 1PI-old\U or 1DEM =SUB later or 1PI-glare\U  
*uis fee mnasi? ai? fee mnasi?*  
 lord wife old or wife old

‘I think, when we grow old now, we glare angrily at the lord of the old woman, or the old woman.’

- (79’) b. \* *au ?-ak ai? ta-mnais ai? ia =t, of ai? ta-smeru? uis*  
 1SG 1SG-say or 1PI-old\M or 1DEM =SUB later or 1PI-glare\U lord  
*fee mnasi? ai? fee mnasi?*  
 wife old or wife old

‘(I thought when we grow old or now, we glare angrily at the lord of the old woman, or the old woman.)’ elicit. 25/02/16 p.28

The ungrammatical examples in (78’) and (79’) above are ungrammatical because the tail-head linkage construction contains two M-forms. Tail-head linkage constructions with two U-forms are also unacceptable. This is shown in (75’) below, manipulated versions of example (75) above (repeated below), showing every possible combination of two U-form verbs with and without the connector =*ma*. None of these were judged acceptable.

(75) *nai? Owen ina ?piur?=ee n-mouf, n-mofu =m na-mneuk*  
 Mr. Owen 3SG cloth=3DET 3-fall\M 3-fall\U =and 3-lose\M

(75’) a. \* *nai? Owen ina ?piur?=ee n-mofu, n-mofu =ma na-mneuk*  
 Mr. Owen 3SG cloth=3DET 3-fall\U 3-fall\U =and 3-lose\M

- b. \* *nai? Owen ina ?piur?=ee n-mofu =ma, n-mofu na-mneuk*  
 Mr. Owen 3SG cloth=3DET 3-fall\U =and 3-fall\U 3-lose\M

- c. \* *nai? Owen ina ?piur?=ee n-mofu, n-mofu na-mneuk*  
 Mr. Owen 3SG cloth=3DET 3-fall\U 3-fall\U 3-lose\M

‘(Owen’s handkerchief fell, it fell and was lost.)’ elicit. 15/03/16 p.45

One pattern of tail-head linkage in Amarasí is for the head to be in the M-form and the tail to be in the U-form. In this case the U-form introduces a new event into the storyline which resolves the event described by the tail-head linkage construction. U-forms must be used in combination with M-forms and it is not acceptable for both parts of the tail-head linkage construction to be in the M-form or for both to be in the U-form.<sup>10</sup>

### 7.7.2 U-form tail with M-form head

Tail-head linkage can also involve a U-form tail and an M-form head. The structure of this construction is given in (80). In most examples the tail is followed by one of the connectors *=ma* ‘and’ or *=te* SET ‘when, as’ and/or the head is an obligatory M-form due to a following vowel-initial enclitic (Chapters 5 and §7.4) or as the first member of a serial verb construction (§6.7, §7.2).

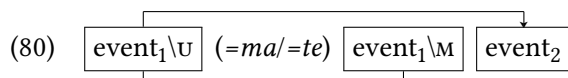

A simple example is given in (81) below. The tail is the U-form *nema* ‘comes’ in (81a). This tail is picked up by the M-form head in (81b), which introduces an event which happens after the subject comes.

- (81) Being healed: 

|        |      |        |               |
|--------|------|--------|---------------|
| come\U | when | come\M | prayed away\M |
|--------|------|--------|---------------|

 120923-1
- a. *nati?* *mu-toon=ee* *na-hiin* *he nema* *=t,*  
*nati?* *mu-tona* *na-hine* *he nema* *=te*  
careful 2SG-tell\M=3SG.ACC 3-know\M IRR 3\come\U =SUB  
‘Ensure you tell him so he knows that if when he comes,’ 6.56
- b. *neem* *he t-?onen* *t-pasat* *t-aan=ee.*  
*nema* *he t-?onen* *t-pasat* *t-ana=ee*  
3\come\M IRR 0-prayUc 0-whack.away\U̇ 1PI-RES\M=3SG.ACC  
‘He comes to have it prayed away.’ 6.59

A similar example is given in (82) below. In this example the U-form verb *n-romi* ‘likes’ occurs in (82b) with an explanation of what is desired introduced by the M-form version of this verb in (82c).

<sup>10</sup>Two U-forms occur in a restricted set of circumstances. See §7.7.3 for more details.

- (82) Naming the village Koro'oto: like\U like\M change 160326
- a. *oka =te siin hai be?i na?i siin na-bua=n =ama,*  
 after.that 3PL 1PX PM PF =ASSOC.PL 3-gather=PL =and  
 ‘Then those ancestors (of ours) gathered and,’ 4.57
- b. *n- n-romi.*  
 3-like\U  
 ‘(they) wanted to.’ 5.02
- c. *n-roim re? kuan=ii kaan-n=ee na-nain?=ee*  
*n-romi re? kuan=ii kana-n=ee na-nani?=ee*  
 3-like\M TOP village=1DET name-3SG.GEN=3DET 3-move\M=3SG.ACC  
*na-?ko Haar?oo n-eu Koor?oot.*  
*na-?ko Haar?oo n-eu Koor?oto*  
 3-ABL Haar'oo 3-DAT Koro'oto\M  
 ‘Wanted to change village’s name from Haar'oo to Koro'oto.’ 5.05

Another example is given in (83) below. In this example the U-form *u-?mate* ‘kill’ is directly followed by the M-form head which introduces an event which follows this action. In this example the head is obligatorily in the M-form due to a following vowel-initial enclitic.

- (83) Trying taps: turn.off\U turn.off\M and not flow 130825-8
- a. *a/?-toro? on re? ia =ma, ohh, idza oe mainikin.*  
*?-toro? on re? ia =ma idza oe mainikin*  
 1SG-catch.liquid\U like TOP 1DEM =and 1DEM water cold  
 ‘I caught the water like this. Ohh, this one is cold water.’ 1.34
- b. [audience laughs] 1.37
- c. *u-?mate,*  
*u-?mate*  
 1SG-kill\U  
 ‘I turned (the tap) off.’
- d. *u-?maatd?=ee =m ka= na-sai =fa.*  
*u-?mate=ee =ma ka= na-sai =fa*  
 1SG-kill\M=3SG.ACC =and NEG= 3-flow =NEG  
 ‘I turned it off and it didn’t flow.’ 1.38

Speakers reject instances in which both parts of the tail-head linkage construction are in the M-form. This is shown in (83') below, in which the tail-head linkage construction of (83) has been manipulated to have two M-forms. This provides evidence that the speaker has intuitively constructed his discourse in (83) so that the M-form which must be an M-form (due to the following vowel-initial enclitic) does not co-occur with another M-form of the same verb.

- (83') \* *u-ʔmaet*, *u-ʔmaatɕ=ee* =*m* *ka=* *na-sai* =*fa*  
*u-ʔmate* *u-ʔmate=ee* =*ma* *ka=* *na-sai* =*fa*  
 1SG-kill\M 1SG-kill\M̄=3SG.ACC =and NEG= 3-flow =NEG  
 '(I turned (it) off, I turned it off and it didn't flow.)' *elicit*. 25/02/16 p.30

In (84) below, tail-head linkage serves not to introduce a subsequent event, but rather to provide details on the manner in which the event was carried out. In this case the tail and head are both forms of *n-rame* 'plasters'. The introduced manner adverbial is *reko~reko* 'properly'. Again, the head is in the M-form due to a following vowel-initial enclitic.

- (84) Digging a grave: 

|           |            |          |
|-----------|------------|----------|
| plaster\U | plaster\M̄ | properly |
|-----------|------------|----------|

130928-1
- a. *iin ka= n-haandɕ=ee* *ruum=aah =fa =te*,  
*ini ka= n-hani=ee* *ruma=aha =fa =te*  
 3SG NEG= 3-dig\M̄=3SG.ACC empty=just =NEG =SUB  
 'He didn't just dig the grave empty (with plain dirt walls).'
- b. *n-hani n-raardɕ=ee* =*te*, *n-rame*.  
*n-hani n-rari=ee* =*te*, *n-rame*  
 3-dig\U 3-finish\M̄=3SG.ACC =SUB 3-plaster\U  
 'When he finished digging it, he plastered (it).' 0.30
- c. *n-raamdɕ=ee* *reko~reko*.  
*n-rame=ee* *reko~reko*  
 3-plaster\M̄=3SG.ACC FRD~good  
 'He plastered it properly.' 0.33

A version of (84) in which the first half of the tail-head linkage occurs in the M-form was judged strange as shown in (84') below. This provides evidence the speaker has intuitively constructed the discourse in (84) to achieve a pairing of a U-form with an M-form.

The only time two M-forms are acceptable is when both occur with a vowel-initial enclitic attached, as in (84'') in which case the metathesis is an automatic response to the presence of a vowel-initial enclitic (see Chapter 5).

Elicitation:

elicit. 09/02/16 p.9



- (84') a. \* *n-hani n-raardɕ=ee* =te, *n-raem*.  
*n-hani n-rari=ee* =te, *n-rame*  
 3-dig\ŭ̇ 3-finish\M̄=3SG.ACC =SUB 3-plaster\M̄  
 '(When he finished digging it, he plastered (it).)'
- b. *n-raamɕ=ee* *reko-reko*.  
*n-rame=ee* *reko-reko*  
 3-plaster\M̄=3SG.ACC FRD~good  
 'He plastered it properly.'
- (84'') a. ✓ *n-hani n-raardɕ=ee* =te, *n-raamɕ=ee*.  
*n-hani n-rari=ee* =te, *n-rame=ee*  
 3-dig\ŭ̇ 3-finish\M̄=3SG.ACC =SUB 3-plaster\M̄=3SG.ACC  
 'When he finished digging it, he plastered (it).'
- b. *n-raamɕ=ee* *reko-reko*.  
*n-rame=ee* *reko-reko*  
 3-plaster\M̄=3SG.ACC FRD~good  
 'He plastered it properly.'

A tail-head linkage construction in Amarasi usually has two identical verbs which differ in the U-form or M-form. A U-form tail is complemented by an M-form head and a U-form head is paralleled by an M-form tail. Speakers intuitively construct their discourse in such a way as to achieve a pairing of a U-form with an M-form. One way to do this is by forcing the head to be in the M-form with a vowel-initial enclitic and having the tail in the U-form.

### 7.7.3 U-form tail with U-form head

There are eleven examples in my corpus of tail-head linkage in which both the tail and the head occur in the U-form. On the face of it, this is a highly unexpected structure as U-forms canonically require an M-form to achieve resolution. However, a closer look reveals that in each instance one of the verbs is in the U-form due to other factors, such as occurring before a consonant cluster or being part of another tail-head linkage construction.

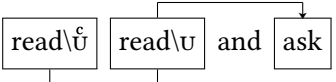
One example is given in (85) below. In this example the tail *m-resa* is in the U-form due to the following consonant cluster, and is thus glossed ‘\ŭ’ (§7.4.3). The head is also in the U-form as it is introducing the next event, which provides its resolution.

(85) Proofreading Bible translations:  130920-1 

a. *bukan hai m-resa n-mees.*  
 bukan hai m-resa n-mese  
 NEG 1PX 1PX/2-read\ŭ 3-alone  
 ‘We didn’t read (it) by itself.’ 3.32

b. *hai m-resa =ma, hai m-mak-tana=n mi-knuut?=ee.*  
 hai m-resa =ma hai m-mak-tana=n mi-knutu?=ee  
 1PX 1PX/2-read\U =and 1PX 1PX/2-RECP-ask=PL 1PX/2PL-fine\m̄=3SG.ACC  
 ‘We read and we asked one another (about it) to refine it.’ 3.34

A very similar example is given in (86) below. In this case the tail (*nema* ‘comes’) of the tail-head linkage construction occurs immediately before a consonant cluster. This consonant cluster is also the first verb of the serial verb construction which contains the head and introduces a new event.

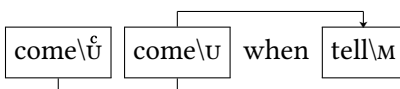
(86) 

*onai =m mes nema n-fain nema =t, na-toon =kau =ma*  
*onai =ma mes nema n-fani nema =te na-tona =kau =ma*  
 and.so but 3\come\ŭ 3-back\M 3\come\U =SUB 3-tell\M =1SG.ACC =and  
 ‘But so (he) came, when he came back he told me.’ 130907-4, 3.21 

Example (87) below is slightly different. In this example the tail-head linkage construction involves two parallel verbs (§7.7.5). The first verb (*t-pafa?* ‘protect’) is consonant final, and thus occurs in the U-form and is glossed ‘\ŭ’ (§7.4.2). The head of the construction then occurs in the U-form to introduce the elaboration; *on re? mee* ‘in which way, how’.

- (87) Burying a dead person: protect\U̇ or bury\U and how 130928-1 🔊
- a. *are? amahonit, ana?aprenat, too mfaun=eni*  
 every elder official citizen many=PL  
*neem na-bua=n =am*  
 3\come 3-gather=PL =and  
 ‘All the clan elders, officials, many people came and gathered’ 0.43
- b. *he na-?uab=ein n-eu re? he*  
 IRR 3-speak=PL 3-DAT TOP IRR  
 ‘to talk about’ 0.48
- c. *a|t-pafa? ai? t-suba =ma, on re? mee.*  
 1PI-protect\U̇ or bury\U =and like TOP how  
 ‘the way in which he should be protected or buried.’ 0.55

Most of the remaining examples of tail-head linkage with both a U-form tail and U-form head are examples in which the head is itself a tail for an anaphoric tail-head linkage construction with the verb *rari* ‘finish’. One of these examples has already been given in (77), the relevant part of which is repeated as (88) below. In (88) the initial M-form *?-iingw* ‘drink’ is the tail of a tail-head linkage construction with following *?-inu* ‘drink’ which is the tail of a tail-head linkage construction with following *u-rari* ‘finish’, which is resolved by the following clause.

- (88) Exploring a hotel room: 130825-8 🔊
- drink\M̄ drink\U and finish\U when enter turn.on tap
- a. *?-took ?-oka bruuk=ii =m ?-ait biir kalen*  
*?-toko ?-oka bruuk=ii =ma ?-aiti biir kalen*  
 1SG-sit\M 1SG-with\U̇ pants=1DET =and 1SG-pick.up\M beer can  
*=siin =m ?-iingw=een*  
*=sini =ma ?-inu=ena*  
 =ASSOC.PL =and 1SG-drink\M̄=INCEP  
 ‘I sat down in the pants, picked up some beer cans and drank.’ 1.06
- b. *?-inu =m u-rari =t, a|?-taam ?-ai kraan=ii,*  
*?-inu =ma u-rari =te ?-tama ?-ai kraan=ii*  
 1SG-drink\U =and 1SG-finish\U =SUB 1SG-enter\M 1SG-push tap=1DET  
 ‘I drank and when I finished, I went in and turned on the tap,’ 1.10



## 7.7.4 Elaboration between tail and head

While the usual pattern in tail-head linkage is for the elaboration to follow the head, the elaboration can also occur between the tail and the head. There are fourteen such examples in my corpus. An English example of tail-head linkage with elaboration between the tail and head is given in (89) below.

- (89) a. *I **arrived** home.*  
 b. *I went straight to the fridge when I **arrived**.*

## 7.7.4.1 U-form tail ... M-form head

There are eight examples in my corpus in which the elaboration occurs between a U-form head and an M-form tail. Such examples are a kind of chiasmus, illustrated in two ways in (90) below. The U-form tail indicates that more information is required for the event to be resolved, with the M-form verb indicating that with the previous information this event is resolved.

(90) Chiastic tail-head linkage:

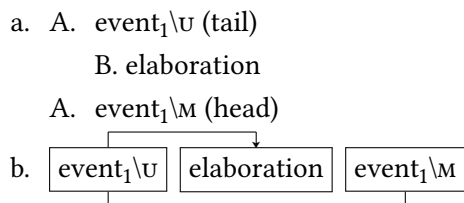

In example (91) below the tail and head of *topu* ‘receive, accept’ occur on either side of information explaining the time and manner in which this event occurred.

(91) A son’s education:

130907-4 🔊

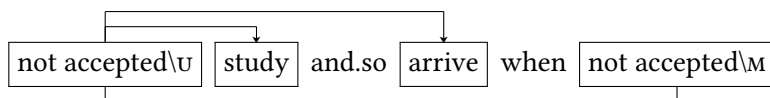

- a. *‘I thought about it first, we’ll have the next one study government’* 3.13  
 b. *‘So Adi went down there,’* 3.15  
 c. *‘And he came back, he came back and told me’* 3.21  
 d. *ka= n-topu =f*  
*ka= n-topu =fa*  
*NEG= 3-receive\U =NEG*  
*‘he wasn’t accepted’* 3.26

- e. *bait he aam Adi iin na-skora prenat.*  
 bait he ama Adi ini na-skora prenat  
 actually IRR father Adi 3SG 3-study\U government  
 ‘Actually Adi was going to study government.’ 3.28
- f. *onai =m mes a/n-tee ne? nahe-n ne? skoor nahe-n*  
 onai =ma mes n-tea ne? nahe-n ne? skoor nahe-n  
 and.so but 3-arrive TOP down-3SG.GEN TOP school down-3SG.GEN  
*nee =te ka= n-toup =fa.*  
 nee =te ka= n-topu =fa  
 there =SUB NEG= 3-receive\M =NEG  
 ‘But he arrived at the school down there and wasn’t accepted.’ 3.35

A more complex example is given in (92) below, in which the U-form verb *n-mate* ‘dies’ is the tail. In this case the elaboration between the tail and head is itself an instance of dependent coordination (§7.6) which describes the manner in which the death will occur. This elaboration is followed by the M-form head, which signals that the previous information has resolved the event (*n-mate* ‘dies’) encoded by the tail and head.

- (92) Someone who is ready for when he dies: 130913-1, 0.16 🔊

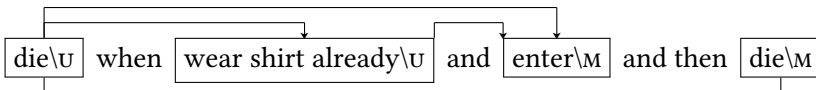

- a. *ona =t of iin n-mate =t, iin na-baur n-ani =m,*  
 onai =te of ini n-mate =te ini na-baru n-ani =ma  
 then later 3SG 3-die\U =SUB 3SG 3-shirt\M 3-before\U =and  
 ‘Then later he’ll die while wearing a shirt (previously selected for the occasion of his death) and’
- b. *iin n-taam n-eu peetǵ=ee =m, na? n-maet.*  
 ini n-tama n-eu peti=ee =ma na? n-mate  
 3SG 3-enter\M 3-DAT coffin=3DET =and then 3-die\M  
 ‘he’ll get into the coffin and only then (will he) die.’

#### 7.7.4.2 M-form tail ... U-form head

I also have six examples in my corpus in which a tail-head linkage construction with medial elaboration has an M-form tail and U-form head. Such constructions typically have two pieces of elaboration, one between the tail and head and one

after the head, as illustrated in (93) below. In such constructions the U-form head signals that the previous information is not the only extra information.

(93) Chiastic tail-head linkage:

- a. A.  $\text{event}_1 \setminus \text{M}$  (tail)  
     B.  $\text{elaboration}_1$   
     A.  $\text{event}_1 \setminus \text{U}$  (head)  
     B.  $\text{elaboration}_2$
- b. 

|                                     |
|-------------------------------------|
| $\text{event}_1 \setminus \text{M}$ |
|-------------------------------------|

 $\text{elaboration}_1$ 

|                                     |
|-------------------------------------|
| $\text{event}_1 \setminus \text{U}$ |
|-------------------------------------|

|                        |
|------------------------|
| $\text{elaboration}_2$ |
|------------------------|
- 

One example is given in (94) below in which the narrator describes the destruction of various objects associated with traditional religion after the village of Koro'oto converted to Christianity. In (94e) the noun *fua-t* 'items used in traditional religion' occurs as the patient of the M-form verb *n-out* 'burnt'. After this M-form verb, (94e) and (94f) contain an elaboration of the kinds of items destroyed. This elaboration closes with the U-form verb *n-otu* 'burnt', which introduces (94g), an explanation on the method of destruction.

(94) Converting to Christianity:

160326

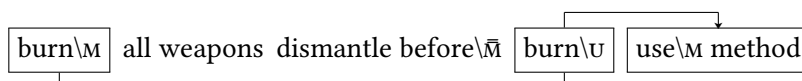

- a. 'They worshipped all kinds of things.' 11.00
- b. 'Too many things.'
- c. 'When the Church came, it said "Stop those things.'" 11.02
- d. *are? siin baer fua-t=eni* *n-nona? =sini =ma*  
*are? sini bare? fua-t=eni* *n-nona? =sini =ma*  
 every 3PL thing traditional.religion-NML=PL\U 3-hand\U =3PL\U =and  
*n-out =siin.*  
*n-otu =sini*  
*3-burn\M =3PL*  
 'All their items of traditional religion were handed over and burnt.'  
 11.06
- e. *are? suni? are? kenat,*  
 every sword every weapon  
 'All (their) swords, all (their) weapons.' 11.10

7 Discourse-driven metathesis

- f. *are? uim fua-t, uim re?gw=ee msa?*  
*are? umi fua-t umi re?u=ee msa?*  
 every house traditional.religion-NML house sacred=3DET also  
*a|n-pukai n-aandɔ̃=ee, n-otu*  
*n-pukai n-ani=ee n-otu.*  
 3-dismantle 3-before=3SG.ACC 3-burn\U  
 ‘every house of traditional religion, even the sacred house was pulled down and then burnt.’ 11.13
- g. *henati?, n-paek re? ʔara re? ia,*  
 IRR 3-use\M TOP method REL 1DEM  
 ‘This was the method they would use,’ 11.18
- h. *‘(they did it) this way so that people forgot the kinds of things they used to do in past days.’* 11.25

A second example is given in (95) below. In this example the M-form verb *n-ok* ‘with’ in (95b) precedes a description of the kinds of things the narrator and his companion did together, while the U-form verb in (95c) both follows and precedes something that the narrator did alone.

(95) Attending church meetings: 130907-3 🔊



- a. *‘And so when he arrived here I hadn’t stopped (working) yet.’* 8.27
- b. *n-ok =kau =m hai nua =kai m-meup onai =m*  
*n-oka =kau =ma hai nua =kai m-mepu onai =ma*  
 3-with\M =1SG.ACC and 1PX two 1PX.ACC 1PX/2-work\M and.so  
 ‘(He) joined with me and both of us worked and so’ 8.31
- c. *karu si- sidan, sidan klasis =ate, iin ka= n-oka =f.*  
*karu sidan, sidan klasis =te ini ka= n-oka =fa*  
 if meeting meeting presbytery =SUB 3SG NEG= 3-with\U =NEG  
 ‘If it was a meeting, a presbytery meeting, he didn’t join.’ 8.36
- d. *au ees a-na~nao-t. au ees a-tok~took sidan.*  
*au esa a-na~nao-t au esa a-tok~toko-s sidan*  
 1SG COP NML-INTNS~go-NML 1SG COP NML-INTNS~sit meeting  
 ‘I was the one who went (*lit.* goer). I was the one who attended the meetings (*lit.* meeting sitter).’ 8.40

Example (95) has two interlocking chiasmic structures. One is the tail-head linkage construction composed of the M-form and U-form of *n-oka* ‘with’, the other is the repetition of attendance at meetings which occurs on either side of the head of this tail-head linkage construction. The structure of (95) is given in (96) below.

(96) Double chiasmus in (95):

- A. *join with*\M  
 B. *work*  
 C. *attend meetings*  
 A. *didn't join with*\U  
 C. *attend meetings*

A tail-head linkage construction can also have a piece of elaboration between the tail and the head. When this is the case U-form tails are resolved by the intermediate piece of elaboration, as illustrated in (97) below. When the head is in the U-form, it introduces another piece of elaboration in addition to that which occurs between the tail and head, as illustrated in (98) below.

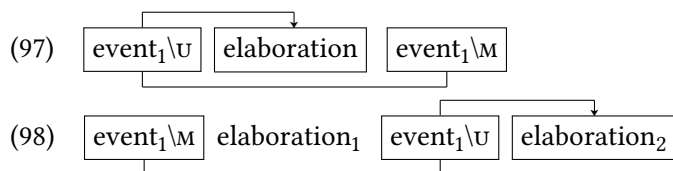

### 7.7.5 Semantically parallel verbs

Although the normal pattern in tail-head linkage is for tail and head to be encoded by identical verbs, it is quite frequent for the two words to be semantically parallel but not identical. Of the 72 instances of tail-head linkage in my corpus, fifteen involve parallel word pairs (21%).

One example is given in (99) below, in which the first clause consists of the serial verb construction *na-skeke n-fena n-hake* ‘sudden rise stand’ with a final U-form *n-hake*.<sup>11</sup> This U-form is resolved in the third clause by the elaboration introduced by the M-form *n-feen*.

<sup>11</sup>The only U-form of this serial verb construction which is in the U-form for discourse reasons alone is the final verb. The other U-forms are all followed by a consonant cluster, an environment which discourages M-forms (§4.6).

- (99) How the snake
- Moo'hitu'*
- separated the sky from the land: 120715-4
- 

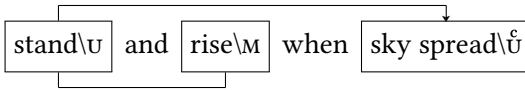

- a. *iin na-skeke n-fena n-hake =ma*,  
3SG 3-sudden\U 3-rise\U 3-stand\U =and  
'He suddenly stood up and' 0.25
- b. *iin, iin n-feen es mee =t*  
ini ini n-fena es mee =te  
3SG 3SG 3-rise\M IPFV.LOC where =SUB  
'he, as he rose up to somewhere,'
- c. *neengw=ii na-tsiri?, na-tsiri? sampe iin n-tea re? aat neno*  
nen=ii na-tsiri? na-tsiri? sampe ini n-tea re? ata neno  
sky=1DET 3-spread\U 3-spread\U until 3SG 3-arrive REL up sky  
*nee msa? iin na-tuin=ee =ma*  
nee msa? ini na-tuin=ee =ma  
3DEM also 3SG 3-follow=3SG.ACC =and  
'the sky spread (and) spread until when he arrived at (the place) where  
the top of the sky also is, he followed it and' 0.30

Another example is given in (100) below. In this example the serial verb construction *?-foro ?-mate* 'dead (completely) blind' with a final U-form in (100c) is the tail. This U-form is resolved by the M-form head *ka= ?-iit* 'not see' in (100d), which introduces the elaboration.

- (100) Receiving a text message that can't be read: 130825-6
- 

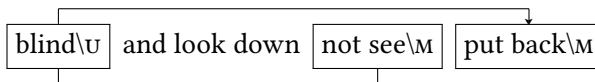

- a. 'I was bathing and this SMS made a noise in the mobile phone.' 9.06
- b. 'I took it and looked at it but' 9.10
- c. *hoo m-bi re? nahen poo?n=ee =te*,  
hoo m-bi re? nahen po?on=ee =te  
2SG 1PX/2-RL.LOC TOP down orchard=3DET =SUB  
*?-foro ?-mate =m*  
1SG-foro 1SG-mate =ma  
1SG-blind\U 1SG-die\U =and  
'When you were down in the orchard, I was dead (completely) blind  
and' 9.12

- d. *?-tae, ka= ?-iit, u-tunu? u-fain.*  
 ?-tae ka= ?-ita u-tunu? u-fani  
 1SG-look.down NEG= 1SG-see\M 1SG-put\U 1SG-back\M  
 ‘I looked down at (it), couldn’t see (it), (so I) put it back.’ 9.14

The tail and head of a tail-head linkage construction can either be identical verbs or semantically parallel verbs. The use of U-forms and M-forms with parallel verbs is discussed in more detail in §7.8 on parallelism in Amarasí poetry.

## 7.8 Poetic parallelism

Another use of U-forms is in poetry. In Amarasí poetry a semantically parallel pair of verbs can also occur with complementary U-forms and M-forms. An example is given in (101) below in which the verb *m-tenu* ‘shade (with umbrella)’ is both semantically and morphologically parallel to the next verb *mu-haof* ‘shade’.

- (101) *henati? m-tenu =m mu-haof too\_tafa? =kai*  
*henati? m-tenu =ma mu-hafo too\_tafa? =kai*  
 IRR 1PX/2-umbrella\U =and 2SG-shade\M citizen =1PX.ACC  
 ‘So that you might shade [doublet] us people.’ 130825-3, 1.21 🔊

Poetry in the Timor region makes extensive use of semantic parallelism. Semantic parallelism is the pairing of related words or phrases to ‘say the same thing twice’. Other terms used for this phenomenon include *speaking in pairs* and *dyadic speech*, with the semantically paired words called a *doublet*. An English Biblical example from Isaiah 65:17–19 is given in (102) below, with doublets linked by connecting lines.

- (102) 17 a. *Behold, I will create new heavens and a new earth.*  
 b. *The former things will not  
 be remembered, nor will they come to mind.*  
 18 a. *But be glad and rejoice forever in what I will create,*  
 b. *for I will create Jerusalem to be a delight and its people a joy.*

- 19 a. I will rejoice over Jerusalem and take delight in my people;  
 b. the sound of weeping and of crying will be heard in it no more.

Each verse is divided into two parts, each of which contains at least one doublet. In some cases the words are opposites, such as the pair *heavens/earth* in verse 17, but more often the pairs are of words or phrases which mean similar things, such as the pair *weeping/crying* in verse 19. The members of such pairs are effectively synonymous when used as a doublet even if they are not exact synonyms when used individually in other contexts.

A specific kind of semantic parallelism is canonical parallelism. Canonical parallelism is a circumscribed system of semantic parallelism in which the words and phrases which may form pairs are pre-defined. In such a system speakers are not free to innovate new pairs.

Canonical parallelism has been extensively studied in eastern Indonesia by James Fox (see particularly Fox 1988; 2014) who has been especially interested in poetry of the island of Rote, neighbouring the Timor mainland where Meto is spoken. An example of Rote parallelism is given in (103) below. This example consists of the first six lines of a particular chant. Each pair of lines contains three words each of which is paired with another word in the next line.

(103) Poetic parallelism in Rote:<sup>12</sup> Fox (1974: 76f)

- a. *lole faik ia dalen ma lada ledok ia tein naa*  
 good day this inside and fine time this stomach that  
 ‘On this good day, and at this fine time.’
- b. *lae: tefu mangona lilok ma huni malapa losik*  
 say sugarcane sheathed gold and banana blossomed copper  
 ‘They say: the sugarcane has sheaths of gold, and the banana has blossoms of copper.’
- c. *tefu olu heni ηgonan ma huni kono heni lapan*  
 sugarcane shed away sheath and banana fall away blossom  
 ‘The sugarcane sheds its sheath, and the banana drops its blossom.’

<sup>12</sup>Each pair of lines has been combined into a single typed line in (103) to show clearly the links between paired words. Morpheme breaks are not shown to reduce clutter.





When an Amarasi doublet consists of two verbs and the connector =*ma* ‘and’ occurs between them, it is usual for the first verb to take the M-form. This is consistent with the use of M-forms before =*ma* as discussed in §7.6.1.1, in which each verb encodes a single event rather than two discrete events. Three examples of verbal doublets with an initial M-form are given in (105)–(107) below.

- (105) *hai mi-ʔ-futu-ʔ =kii ʔ-fuut nafe, henati?*  
*hai mi-ʔ-futu-ʔ =kii ʔ-futu-ʔ nafe henati?*  
 1PX 1PX/2PL-TR-tie-TR =2PL.ACC NML-tie belt IRR

*m-fuut* =*ma* *m-nibun* *m-aan* *too\_tafa?* =*kai*  
*m-futu* =*ma* *m-nibun* *m-ana* *too\_tafa?* =*kai*  
 1PX/2-tie\M =and 1PX/2-surround 1PX/2-RES citizen =1PX.ACC

‘We clothe you with a cloth belt so that you will surround and bind us people together.’ 130825-3, 0.51 🔊

- (106) *hai aaʔ-t=ii* *na-m-soup* =*ma* *n-heun-ʔ=oo-n*  
*hai aʔa-t=ii* *na-m-sopu* =*ma* *n-henu-ʔ=oo-n*  
 1PX poetry-NML=1DET 3-STAT-finish\M =and 3-fill\M-TR=REFL-3SG.GEN  
*on naan nai tua.*  
*on naan nai tua.*  
 like 2DEM already ADDR

‘Our poetry is now finished and complete like that.’ 130825-3, 2.35 🔊

- (107) *mes au ka= ʔ-sium* =*ma* *ʔ-toup* =*fa* *nai? Esau.*  
*mes au ka= ʔ-simo* =*ma* *ʔ-topu* =*fa* *nai? Esau*  
 but 1SG NEG= 1SG-receive\M =and 1SG-receive\M =NEG Mr. Esau

‘But I did not receive [doublet] Esau.’ Romans 9:13

However, it is also possible for the first verb of the doublet to occur in the U-form with the second verb in the M-form. One example is given in (108) below.

(108) Greeting (*aʔa sramat*):120715-0 

- a. *iin tua-n=ee ees-, ees nai? Bani, nai? Ora?*  
*ini tua-n=ee esa nai? Bani nai? Ora?*  
 3SG owner-3SG.GEN=3DET one Mr. Bani Mr. Ora'  

|               |      |               |                                 |
|---------------|------|---------------|---------------------------------|
| <i>n-simo</i> | =ma  | <i>n-toup</i> | <i>tuaf am-nema-t tamu nee</i>  |
| n-simo        | =ma  | n-topu        | tuaf am-nema-t tamu nee         |
| 3-receive\U   | =and | 3-receive\M   | person NML-come-NML guest PAUSE |

 'Its lords the Bani and Ora' clans receive [doublet] those who come (and those who are) guests.' 0.51
- b. *AMNEMAT* 0.58

In (108) the U-form *?simo* is paired with M-form *?toup* 'receive'.<sup>13</sup> Another example of the same pair with alternate U-form and M-forms is given in (109) below, a prayer composed and written by my main consultant Roni. A scan of the original is given in Figure 7.1 following.

(109) Prayer for the offertory collected in Church:

- a. *a-ma-hoe-t a-ma-neka-t hai usi?*  
 NML-PROP-bless-NML NML-PROP-love-NML 1PX lord,  
 'Our loving and generous lord,'
- b. *a/n-bi Yesus Kristus fuaʔturu ?honis.*  
 3-RL.LOC Jesus Christ offering living  
 'in (the name of) Jesus Christ, the living sacrifice.'
- c. *hai m-nona? =ma m-fee fuaʔturu? re? hai*  
*hai m-nona? =ma m-fee fuaʔturu? re? hai*  
 1PX 1PX/2-hand\U =and 1PX/2-give offering REL 1PX  

|               |      |               |                  |
|---------------|------|---------------|------------------|
| <i>n-simo</i> | =ma  | <i>n-toup</i> | =siin mi-ʔko     |
| n-simo        | =ma  | n-topu        | =siin mi-ʔko     |
| 3-receive\U   | =and | 3-receive\M   | =3PL 1PX/2PL-ABL |

*hoo ?nima-m a-ma-neka-b,*  
*hoo ?nima-m a-ma-neka-b,*  
 2SG hand-1PX/2GEN NML-PROP-love-TR  
 'We give offerings we received from your loving hand.'

<sup>13</sup>The normal word for 'receive' in Amarasi is *topu*, with *simo* only occurring in poetic parallelism. The verb *simo* is from another variety of Meto in which this is the normal word for 'receive' – a common strategy to create parallel pairs (Grimes et al. 1997: 27f).

7 Discourse-driven metathesis

- d. *ka= baʔ~bauʔk=ein =fa, fuʔ~fuʔan na-heun n-ok rahi*  
 NEG= INTNS~many=PL =NEG INTNS~few 3-full\M 3-with\M filth  
*oe\_metan,*  
 dirt  
 '(It's) not very much, (but) very little (and) filled with filth and dirt.'
- e. *mes hai m-eik =sien m-eu =koo usi, m-eik*  
 but 1PX 1PX/2-bring\M =3PL 1PX/2-DAT =2SG.ACC Lord 1PX/2-bring\M  
*Yesus iin kana-n.*  
 Jesus 3SG name-3SG.GEN  
 'but we bring them to you Lord, in Jesus's name.'

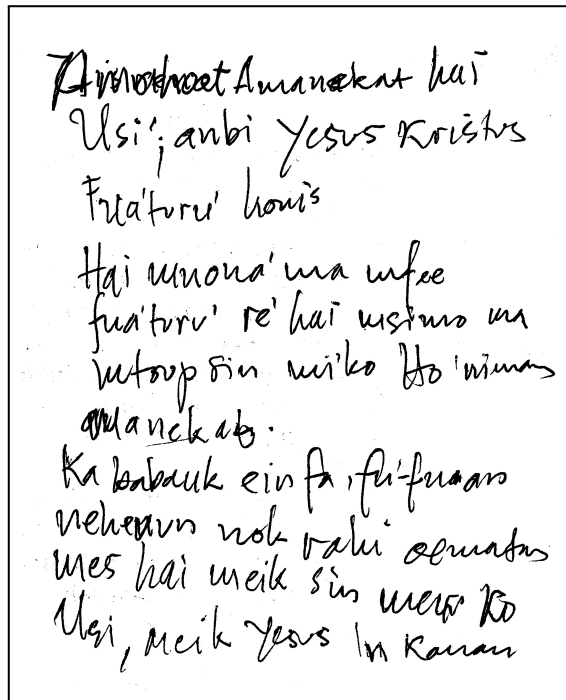



Figure 7.1: Prayer for the offertory collected in church

A third example of parallel verbs with an alternate U-form and M-form is given in (110). In this case the doublet is *tenu // hafo* 'umbrella : shade'.

(110) Speech to welcome new government officials: 130825-3 

- a. *hai mi-ʔpiruʔ =kii ʔpiur suun mees nua*  
*hai mi-ʔpiruʔ =kii ʔpiruʔ suna meseʔ nua*  
 1PX 1PX/2PL-cloth\U =2PL.ACC cloth horn single two  
 ‘We give you two single bandannas (as a) horn’ 1.15

- b. *henatiʔ m-tenu =m mu-haof too\_tafaʔ =kai*  
*henatiʔ m-tenu =ma mu-hafo too\_tafaʔ =kai*  
 IRR 1PX/2-umbrella\U =and 2SG-shade\M citizen =1PX.ACC  
 ‘so that you might shade [doublet] us people.’ 1.21

The two main patterns in which an Amarasi poetic doublet of parallel verbs occur are given in (111) and (112) below.

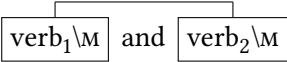
(111) 

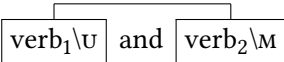
(112) 

In non-poetic discourse the use of a U-form followed by *=ma* indicates that the event marked by the U-form preceded the event encoded in the next clause, as discussed in §7.6.1. However, in poetry such U-forms do not indicate the timing of events. Instead, the use of U-forms and M-forms is a poetic device, providing the option of a double parallelism on complementary verbs; such verbs are both semantically and morphologically parallel.

## 7.9 Centre of chiasmus

Another use of discourse U-forms is to mark the centre of a chiasmus. Chiasmus is a kind of inverted parallelism in which parallel pairs are repeated on either side of another parallel pair. A simple example of chiasmus in English is given in (113) below from act 1, scene 1 of Shakespeare’s *Macbeth*.

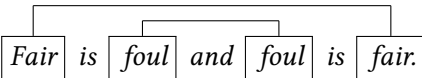
(113) 

In Amarasi a U-form can occur in the middle of chiasmus to signal that the information before this U-form is going to be repeated again, as illustrated in (114) and (115) below. There are 20 examples of U-forms marking chiasmus in my corpus.

(114) Chiastic U-forms:

- A. information<sub>1</sub>
- B. verb\U
- A. information<sub>1</sub>

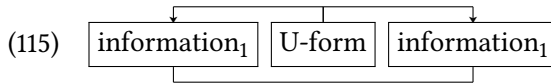

By using a U-form in such examples the speaker signals non-resolution and puts the listener in a mild state of suspense, communicating roughly ‘This is unresolved. Pay attention’. The listener would thus be prepared for something unexpected. By repeating old information instead of providing something new, the speaker emphasises this repeated information. The U-form is resolved by the information on either side of it.

At its most simple, such U-forms are preceded and followed by an identical word or phrase. This simple chiastic structure constitutes nearly all instances of chiasmus with a central U-form in my corpus (18/20 instances). One example is given (116) below, in which the U-form *n-moni* ‘lives’ is both preceded and followed by M-forms of the verb *n-bo?is* ‘praises’.

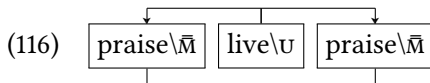

*n-boi?s=ee*      *mate-s. aam baab-f=ee*      *n-moni =te,*  
*n-bo?is=ee*      *mate-s ama baba-f=ee*      *n-moni =te*  
 3-praise=3SG.ACC die-NML father FZ/MB-GEN=3DET 3-live\U =SUB  
*n-boi?s=ee.*      ???<sup>14</sup>  
*n-bo?is=ee*  
 3-praise=3SG.ACC

‘He praised him a lot (*lit.* dead). While the uncle was alive, he praised him.’  
 130925-1, 4.10 ◀



A more complex example is given in (118) below, in which the material which surrounds the U-form is repeated multiple times, including two repetitions which are not identical but parallel. The structure of this chiasmus is given in (117).

<sup>14</sup>The final word/phrase of this sentence was not transcribed by Roni, who recorded and transcribed this text. Due to the faintness of the recording, I also cannot make out the final word/phrase of this sentence. My best guess is that it is *na-hiind?e=ee* ‘he knew it/him’.

(117) Chiasmus of (118):

- A. *na-pein=koo* = ‘gets you’  
 A. *na-pein=koo* = ‘gets you’  
     B. *t-so?i* = ‘counts\U’  
 A’. *n-naa?=koo* = ‘holds you’  
 A’. *n-naa?=koo* = ‘holds you’  
 A. *na-pein=koo* = ‘gets you’

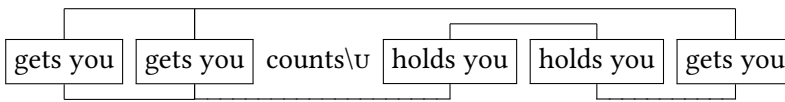
(118) Catching a thief in your garden:

120923-2 

- a. *karna tuan=ee na-pein =koo, na-pein =koo*  
*karna tuan=ee na-peni =koo na-peni =koo*  
 because owner=3DET 3-get\M =2SG.ACC 3-get\M =2SG.ACC  
*naa?g=ena =ma*  
*nai=ena =ma*  
 already=INCEP =and  
 ‘Because the owner gets you, he’s got you already and’ 4.29
- b. *t-so?i =t iin n-naa? =koo,*  
*t-so?i =te ini n-na?a =koo*  
 0-count\U =SUB 3SG 3-hold\M =2SG.ACC  
 ‘(someone) counts while he holds you’ 4.32
- c. *n-naa? =koo na-heer=een ees re?*  
*n-na?a =koo na-hera=ena esa re?*  
 3-hold\M =2SG.ACC 3-tight=INCEP one REL  
*iin na-pein =koo re? ia.*  
*ini na-peni =koo re? ia*  
 3SG 3-get\M =2SG.ACC REL 1DEM  
 ‘He holds you tight like this, the one who’s got you here.’ 4.34

The U-forms in examples (116) and (118) have a dual function, marking both chiasmus and dependent coordination (§7.6). In these cases the information which resolves the U-form is similar/identical to that which precedes the U-form.

In addition to such examples in which there is only a single layer on either side of the U-form, there are at least two examples of a more complex chiasitic

structure in which there is more than one layer surrounding the U-form, as exemplified in (119) and (120) below.

(119) Complex Chiasmus:

- A. information<sub>1</sub>
- B. information<sub>2</sub>
- C. verb\U
- B. information<sub>2</sub>
- A. information<sub>1</sub>

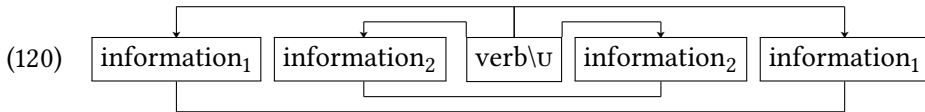

The first of these examples is given in (122) below. This example consists of an outer layer ('I just followed the target') and an inner layer ('I couldn't offer') with the core U-form *?-nesi* 'more'. The chiasmic structure of (122) is given in (121).

(121) Chiasmus in (122):

- A. *I just followed the target*
- B. *I couldn't offer*
- C. *any more\U*
- B. *I couldn't offer*
- A. *I just followed the target*

(122) Donating money:

130825-6

- a. *au ?-tuin=aah ne? target.*  
1SG 1SG-follow=just TOP target  
'I just followed the target.'
- b. *au ka= bisa ?-korban a/?-nesi =f.*  
*au ka= bisa ?-korban ?-nesi =fa*  
1SG NEG= can 1SG-sacrifice 1SG-more\U =NEG  
'I couldn't offer any more.'
- c. *au ka= bisa ?-korban.*  
1SG NEG= can 1SG-sacrifice  
'I couldn't offer.'

2.57



- d. *au ?-tuin=aah ne? target.*  
 1SG 1SG-follow=just TOP target  
 ‘I just followed the target.’

3.01

A second example is given in (124) below, with the chiastic structure summarised in (123). In this example the outer layer consists of the person *Olpi*, the inner layer consists of the activity ‘went down to bathe’, and the U-form in the centre in (124b) is *n-sae n-fani* ‘came back up’. This core is also followed by an additional event in (124).

(123) Chiasmus in (124):

- A. *Olpi*  
 B. *went down to bathe*  
 C. *came back\U up*  
 D. *handed me a towel and soap*  
 B. *I went down to bathe*  
 A. *Olpi*

(124) The narrator and *Olpi* are down at the garden:

130825-6 

- a. *Olpi n-saun na-niu =ma nsa-*,  
*Olpi n-sanu na-niu =ma*  
*Olpi 3-go.down\M 3-bathe =and*  
 ‘*Olpi went down to bathe and*’ 9.20
- b. *n-sae n-fani =t*  
*n-sae n-fani =te*  
*3-go.up 3-back\U =SUB*  
 ‘*when he came back up,*’ 9.22
- c. *n-nona? =kau nehh, n-nona? =kau nehh, handuk =am sabu*  
*n-nona? =kau n-nona? =kau handuk =ma sabu*  
*3-hand =1SG.ACC 3-hand =1SG.ACC towel =and soap*  
 ‘*he handed me handed me a towel and soap.*’ 9.23
- d. *?-saun u-niu =t,*  
*?-sanu u-niu =te*  
*1SG-go.down\M 1SG-bathe =SUB*  
 ‘*I went down and bathed while*’ 9.27

- e. *Olpi n-ait*            *nehh, hap- hapeedz=ii*  
*Olpi n-aiti*                *hapei=ii*  
*Olpi 3-pick.up\M*            *mobile.phone=1DET*  
 ‘Olpi picked up the mobile phone’ 9.28

U-forms can mark the centre of a chiasmus. By introducing a U-form the narrator sets up the discourse as unresolved and introduces the possibility of an unexpected event. By then denying this possibility and repeating the information which occurred before the U-form, the narrator emphasises the repeated information. A U-form in the centre of chiasmus is resolved by the information on either side of it.

## 7.10 Interactional metathesis alternations

Another use of discourse U-forms is in conversation to maintain interaction between speakers. By using a U-form in conversation, the speaker flags that s/he considers the communicative act unresolved. This provides an opportunity for other participants to make their own contribution and resolve the U-form. In my corpus there are 53 instances of U-forms which are intended to elicit a response from the addressee. This frequency is discussed in more detail in §7.10.3.

### 7.10.1 Question and answer

The clearest example of U-forms being used in interactions between speakers is in question-answer pairs. U-forms are used to ask questions and M-forms are used to answer such questions. The normal structure of an Amarasi question-answer pair is given in (125) below. The question and answer usually contain identical verbs, with the question U-form being resolved by an M-form answer. A typical example is given in (126). Here, and throughout this section, Greek letters are used to mark different speakers.

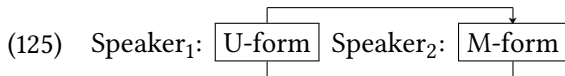



- (126) Climbing a steep hill: observation 02/08/13, p.20  
 a.  $\alpha$ : *hoo mu-be?i?* b.  $\beta$ : *au u-bei?!*  
     2SG 2SG-capable\U 1SG 1SG-capable\M  
     ‘Can you do it?’ ‘Yes, I can!’



Such question-answer pairs are similar to tail-head linkage (§7.7) or poetic parallelism (§7.8), with the difference that the U-form/M-form doublet is constructed by multiple speakers. A U-form question must be complemented by an M-form answer and a U-form answer is judged as infelicitous. This is shown in (126') below, which can be compared with grammatical (126) above.

- (126') Elicitation: elicit. 03/10/14 p.112
- |                                                                          |                                                                      |
|--------------------------------------------------------------------------|----------------------------------------------------------------------|
| <p>a. <i>hoo mu-be?i?</i><br/>2SG 2SG-capable\U<br/>'Can you do it?'</p> | <p>b. # <i>au u-be?i</i><br/>1SG 1SG-capable\U<br/>'Yes, I can!'</p> |
|--------------------------------------------------------------------------|----------------------------------------------------------------------|

Two examples of question\U-answer\M pairs from recorded conversations are given in (127) and (128) below. In each example a question posed in the U-form is answered by another speaker with an M-form version of the same verb.

- (127) Weaving cloth: 130914-1 
- |                                                                                                                                                                                   |             |
|-----------------------------------------------------------------------------------------------------------------------------------------------------------------------------------|-------------|
| <p>a. <math>\alpha</math>: <i>he t-futu?</i><br/>he t-futu<br/>IRR 1PI-bind\U<br/>'Should we tie it?'</p>                                                                         | <p>0.20</p> |
| <p>b. <math>\beta</math>: <i>t-fuut, re? muti? re? ia.</i><br/>t-futu re? muti? re? ia<br/>1PI-bind\M REL white REL 1DEM<br/>'(Yes,) we tie it. The white one which is here.'</p> | <p>0.21</p> |
- (128) Inquiring about family: 130909-6 
- |                                                                                                                                                                                                                                                    |             |
|----------------------------------------------------------------------------------------------------------------------------------------------------------------------------------------------------------------------------------------------------|-------------|
| <p>a. <math>\alpha</math>: <i>ehh, n-fain=n=ena? nai? Rius iindz=aan n-fani?</i><br/>n-fani=n=ena nai? Rius ini=ana n-fani<br/>3-back\M=PI=INCEP Mr. Lius 3SG=2DET 3-back\U<br/>'Ahh, they've come back, right? Lius's (child) has come back?'</p> | <p>3.23</p> |
| <p>b. <math>\beta</math>: <i>iin n-fain, tua.</i><br/>ini n-fani tua<br/>3SG 3-back\M ADDR<br/>'He's come back.'</p>                                                                                                                               | <p>3.25</p> |

However, it is not a rule of Amarasi grammar that questions *must* be posed in the U-form. Two examples of questions posed in the M-form are given in (129) and (130) below. In each example the M-form question also elicits a response (partially) in the M-form.

- (129) Going to Jakarta: 130825-7 
- a.  $\alpha$ : *n-moa? on mee =m esa n-heek n-aan =koo n-ok*  
*n-mo?e on mee =ma esa n-heke n-ana =koo n-oka*  
 3-do\M like how =and one 3-catch\M 3-RES\M =2SG.ACC 3-with\M  
*bifee? atau, ai? hoo m-mouf?*  
*bifee atau ai? hoo m-mofu*  
 woman or or 2SG 1PX/2-fall\M  
 ‘How did it happen, that is did they catch you with the woman? Or did you fall (morally)?’ 1.28
- b.  $\beta$ : *ka= n-heek =kau =f!*  
*ka= n-heke =kau =fa*  
 NEG= 3-catch\M =1SG.ACC =NEG  
 ‘They didn’t catch me!’ 1.31
- (130) A man who’s already made preparations for his funeral: 130913-1 
- a.  $\alpha$ : *m-ak iin n-hain n-mees?*  
*m-ak ini n-hani n-mese*  
 1PX/2-say 3SG 3-dig\M 3-alone\M  
 ‘Do you think he dug it alone?’ 0.57
- b.  $\beta$ : *iin ofa n-hani n-mees.*  
*ini ofa n-hani n-mese*  
 3SG sure 3-dig\U 3-alone\M  
 ‘He must’ve dug it himself.’ 0.59

A useful tool for analysing U-form/M-form question-answer pairs in Amarasi is provided by the notion of an *adjacency pair*, a concept developed by Schegloff & Sacks (1977: 295) within the field of conversation analysis. An adjacency pair has the following properties:

- (131) An adjacency pair:
- a. consists of two conversational turns:
    - i. which are by different speakers
    - ii. which are placed next to one another
    - iii. which are ordered
    - iv. which are differentiated into pair types

The first part of an adjacency pair is known as the *first pair part* and the second part is called the *second pair part*. Property (131a-iii) refers to the fact that these

two pairs come in a set order: i.e. a question (first pair part) precedes an answer (second pair part). Property (131a-iv) refers to the fact that which second pair part is allowed is constrained by the first pair part. An acceptable second pair part for a greeting is another greeting, while an acceptable second pair part for a question is an answer.

The Amarasí examples seen so far in this section are question-answer adjacency pairs. U-forms occur as first pair parts (questions) and M-forms occur in second pair parts (answers).

A first pair part projects the relevant second pair part. If the relevant second pair part is lacking, the conversation is viewed as problematic or incomplete. Thus, for instance when a speaker asks a question, they expect to receive an answer. This is illustrated with the English example in (132) below, taken from Liddicoat (2007) with the transcription adapted to the same transcription conventions used in this book.

- (132) A conversation: Liddicoat (2007: 108)
- a.  $\alpha$ : *Did you speak to Mary today?*
  - b. [0.2 seconds of silence]
  - c.  $\alpha$ : *Did you speak to Mary?*
  - d.  $\beta$ : *Oh, yeah I saw her at lunch.*

In (132a) speaker- $\alpha$ 's question is followed by 0.2 seconds of silence, which is interpreted by speaker- $\alpha$  as the answer being absent, as a result s/he repeats the question in (132c) which induces the required answer in (132d).

Within the terminology of conversation analysis, a U-form in Amarasí explicitly flags a turn as the first pair part of a question-answer adjacency pair.<sup>15</sup> This thus projects forward an answer as the second pair part. Within more general terminology, U-forms are one way of marking a question which expects an explicit answer. Such U-form questions are complemented and completed by an M-form answer.

### 7.10.2 Maintaining interaction

U-forms are not only used in questions. but are used more broadly to maintain ongoing interaction and conversation between speakers. One example is given in

---

<sup>15</sup>An interesting topic to pursue for further work would be whether questions posed in the M-form do not require an answer in the same way as those posed in the U-form. It may be the case that U-form questions are first pair parts while M-form questions are not.

(133) below. In this example speaker- $\alpha$  wants to interact with speaker- $\beta$ . Speaker- $\alpha$  initiates a conversation in (133a) and speaker- $\beta$  responds with the M-form *?took* ‘sit’ in (133b). Speaker- $\alpha$  then repeats this answer with a U-form *m-toko* ‘sit’ in (133c). By using a U-form in (133c) speaker- $\alpha$  signals that the interaction is not yet socially complete. When speaker- $\beta$  fails to resolve the U-form, speaker- $\alpha$  does so himself by offering betel nut in (133d), the chewing of which is a core Timorese social activity.

(133) Speaker- $\alpha$  approaches speaker- $\beta$  and friends: observation 19/09/14 p.97

- a.  $\alpha$ : *hoo mu-nsaa??*  
*hoo mu-nsaa?*  
 2SG 2SG-do.what  
 ‘What are you doing?’
- b.  $\beta$ : *au ?took.*  
*au ?-toko*  
 1SG 1SG-sit\M  
 ‘I’m sitting.’
- c.  $\alpha$ : *hoo m-toko?*  
*2SG 1PX/2-sit\U*  
 ‘So, you’re sitting, are you?’
- d.  $\alpha$ : [*approaches group and offers betel nut*]

A similar example is given in (134) below. In (134a) speaker- $\beta$  invites speaker- $\alpha$  to go first at a buffet. This invitation is accepted by speaker- $\alpha$  in (134b) with the U-form *u-hunu* ‘first’; this is a kind of rhetorical question casting. This U-form is then resolved by speaker- $\beta$  nodding that this is indeed the intended desire.

(134) Lining up at a buffet to get food: observation 19/09/14 p.97

- a.  $\beta$ : *hoo mu-huun.*  
*hoo mu-hunu*  
 2SG 2SG-first\M  
 ‘You go first.’ [simultaneously gestures with hands]
- b.  $\alpha$ : *au u-hunu.*  
*1SG 1SG-first\U*  
 ‘I’ll go first, then?’
- c.  $\beta$ : [*nods once and gestures*]
- d.  $\alpha$ : [*starts serving food*]

A number of more complex interactional U-forms are given in (135)–(137). In (135) a group of speakers are discussing what to do about the presence of a voice recorder. Speaker- $\beta$  announces in (135b) his intention with a U-form *?-nene* ‘press’. This verb is then repeated in the M-form by speaker- $\alpha$  who points out that speaker- $\beta$  is not achieving his goal. The U-form is not resolved by the action, but it is resolved by the interaction.

- (135) Turning a voice recorder off: 130825-7 🗣️
- a.  $\alpha$ : *t-sambun peo-t=ee, he bisa beesdʒ=ee na-taah*  
 1PI-continue talk-NML=3DET IRR can machine=3DET 3-answer  
 =*kiit*.  
 =1PI.ACC  
 ‘(If) we keep talking the machine will be able to answer us.’ 3.30
- b.  $\beta$ : *maut he au ?-nene!*  
*maut he au ?-nene*  
 patient IRR 1SG 1SG-press\U  
 ‘Hold on, I’ll press (the buttons)!’ 3.33
- c.  $\alpha$ : *Ae?!*  
 ‘Hey!’ 3.34
- d.  $\beta$ : [*laughs*]
- e.  $\alpha$ : *maan m-neen mu-tafi? beesdʒ=ee naan, kama?*  
*maan m-nene mu-tafi? besi naan kama?*  
 like.that 1PX/2-press\M 2SG-random\U machine\U 2DEM what’s-it  
*Hoe! Australi pupa ini.*  
*hoe Australi pupa ini*  
*hey Australia have this*  
 ‘You’re randomly pressing the machine there, (that) what’s-it. Hey!  
 This belongs to Australia.’ 3.35
- f.  $\alpha$ : *hoo m-ak besi kraufn=ees, ees re? naan on re?*  
 2SG 1PX/2-say machine useless=one one REL 2DEM like TOP  
*hapei=ein re? a-taf~taif?=ein.*  
 mobile.phone=PL REL NML-INTNS~agape=PL  
 ‘You think it’s a useless machine, the one there, like those mobile  
 phones which leave you agape (with confusion).’ 3.40

Example (136) below involves a number of U-forms. None of these U-forms is repeated by another speaker, but in each instance a U-form is followed by the con-

tribution of another speaker. By using U-forms, the speakers indicate that they do not consider the communicative act resolved and thereby open the floor up for contributions from other speakers. The only change of speaker in (136) which does not involve a U-form is that after (136a), in which (136b) is an interruption cutting off the first speaker mid-sentence.

- (136) A conversation about a car which came off the road: 130911-2 
- a.  $\alpha$ : *iin na-reen=oo-n* =*ma n-?antareek a|n-bi n-*  
 3SG 3-force\̄M=REFL=3SG.GEN =and 3-backing 3-RL.LOC  
 ‘He forced himself, and went back into it, was in...’ 0.31
- b.  $\beta$ : *na-bara ma?bake? mhh.*  
 3-forever\U narrow  
 ‘He was stuck in the narrow (place)’ 0.32
- c.  $\gamma$ : *iin he n-bibi.*  
 3SG IRR 3-shrink\U  
 ‘He would’ve wanted to shrink (the car).’ 0.34
- d.  $\delta$ : *n-ak, ootgw=ii, na-snii m-ak,* =*am, na-kamaf* =*am,*  
 3-say car=1DET 3-slope 1PX/2-say and 3-what’s.it\̇U =and  
 ‘he said, the car was sloping, you think, and what’s it and’ 0.35
- e. *na-snii n-taikobi n-koon,* *na? na-tetu*  
*na-snii n-taikobi n-kono na? na-tetu*  
 3-slope 3-fall\̇U 3-keep.on\M then 3\TR-upright\U  
 ‘it was sloping, fell over, kept on, and only then he got the car up-  
 right’ 0.38
- f.  $\beta$ : *onai =ma srutun re? ia, iin n-moofgw=een.*  
 and.so suddenly REL 1DEM 3SG 3-fall\̄M=INCEP  
 ‘and suddenly now it fell down’ 0.40

A similar example of U-forms initiating a change of speakers is given in (137), which only involves two speakers. In this example the change of speakers after each of the following clauses is initiated by a U-form: (137b), (137c), and (137f). This conversation also involves a large amount of repetition, a discourse structure already noted in §7.5 as a feature of Amarasi monologues.

- (137) Preparing a field for planting: 130909-6 
- a.  $\alpha$ : *mu-boor=een,* *ta-boor* *n-ok fuun ne<?>e.*  
 2SG-make.hole=INCEP 1PI-make.hole 3-with\M moon six <ORD>  
 ‘You dug a hole. We dig holes (for planting) in June.’ 1.12



- b.  $\beta$ : *he?*, *t-kanu* =*t*, *na?* *fuun* *ne*\langle?*e*.  
           *t-kanu* =*te* *na?* *funan* *ne*\langle?*e* e  
           hey 1PI-cut.field\U =SUB then moon six \langleORD\rangle  
           ‘What? We cut open a new field, only then is it June.’ 1.15
- c.  $\alpha$ : *ehh*, *t-kanu* =*t*, *na?* *fuun* *ne*\langle?*e*.  
           *t-kanu* =*te* *na?* *funan* *ne*\langle?*e* e  
           oh 1PI-cut.field\U =SUB then moon six \langleORD\rangle  
           ‘Ohh..., we cut open a new field, only then is it June.’ 1.16
- d.  $\beta$ : *t-tofa* ?*teets=ii*.  
           *t-tofa* ?*tetas=ii*  
           1PI-weed\U old.field=1DET  
           ‘We weed the old field.’ 1.18
- e.  $\alpha$ : *t-toof* *n-ok* *fuun* *se*\langle?*o*.  
           1PI-weed\M 3-with\M month\M nine \langleORD\rangle  
           ‘We weed (the field) in September.’ 1.20
- f.  $\beta$ : *hau*, *t-toof* *nai* *he n-meto*, *oo*.  
           *hau t-tofa* *nai* *he n-meto* *oo*  
           yes 1PI-weed\M already he 3-dry\U Q  
           ‘Yes, we weed (the field) after it’s dried out, as you know.’ 1.22
- g.  $\alpha$ : *nejaa*, *nean fauk=ii* *na-?uur?*  
           yeah day how.many=1DET 3-rain\M  
           ‘Yeah... which day did it rain?’ 1.26

U-forms can be used in conversation to maintain interaction between speakers and to motivate a change of speaker. By using a U-form a speaker signals a lack of resolution, while other features such as intonation and silence indicate that the speaker will not resolve the U-form. It thus becomes incumbent on the addressee or audience to provide a resolution to the U-form.

### 7.10.3 Frequency of U-forms in conversation

Discourse U-forms are nearly twice as frequent in conversations as in monologues in my corpus. My Kotos Amarasi text collection consists of 182.49 minutes (three hours two minutes) of recorded, transcribed, and glossed texts. Of this, 154.17 minutes (two hours thirty-four minutes) are monologues: texts which consist mainly of a single speaker, and 28.32 minutes (nearly half an hour) are conversations: texts in which more than one person regularly speaks.

Of the 423 U-forms in my corpus which cannot be explained by phonotactic constraints (§7.4), 312 occur in monologues and 111 occur in conversations. This gives a frequency of 2.02 discourse U-forms per minute in monologues and 3.92 discourse U-forms per minute in conversations. These figures are summarised in Table 7.6.

Table 7.6: Discourse U-forms in monologues and conversations

|                        | Mon.   | Conv. | all    |
|------------------------|--------|-------|--------|
| total length (minutes) | 154.17 | 28.32 | 182.49 |
| discourse U-forms      | 312    | 111   | 423    |
| U-forms per minute     | 2.02   | 3.92  | 2.32   |

That discourse-driven U-forms are nearly twice as frequent in conversations as in monologues lends quantitative support to an analysis of U-forms as being used interactionally by speakers in conversations to motivate turn taking and change of speaker.

#### 7.10.4 Other interactional resources

U-forms are only one of several resources in Amarasi available to speakers to maintain interaction with other speakers. In this section I discuss the way a number of discourse particles interact with discourse-driven U-forms.

The addressee particle *tua* is a polite way in which a speaker can mark their contribution to the discourse as complete. Thus, it cannot co-occur with U-forms, which explicitly flag a lack of resolution. On the other hand the question particles *oo* and *kaah* require a response from the addressee. Thus, they combine naturally with U-forms in direct questions.

##### 7.10.4.1 Addressee particle *tua*

The addressee particle *tua* cannot co-occur with interactional U-forms. This is because such a U-form is unresolved or incomplete and places an obligation on the addressee to respond to the speaker, while *tua* signals that the speaker considers their contribution complete.

The particle *tua* is translated by native speakers as ‘yes’ or ‘Sir/maam’, and they explain that this word makes one’s speech *halus*; Indonesian for ‘smooth, refined, polite’. The particle *tua* is a distinctive feature of Amarasi and nearby

varieties of Meto. The different functions of the particle *tua* found in my corpus are summarised in (138) below, with discussion and exemplification following. It almost always occurs phrase finally.

- (138) Uses of *tua*:
- a. addressing the deceased
  - b. acknowledging one is listening to someone else
  - c. acknowledging instructions to begin a monologue
  - d. ending a monologue
  - e. indicating the end of a turn in a conversation
  - f. taking leave of someone

The particle *tua* has two functions: to politely address another person and for the speaker to signal that their contribution to the discourse is potentially complete. The first part of this use, to address someone, is seen clearly in one particular text; a woman mourning for her recently deceased grandmother. After a death in Amarasi society, the body of the deceased is washed, clothed, prepared for burial, and then laid in an open casket overnight while the family stays awake. When a family member wishes to express their grief, they can do so by addressing the deceased, whose body is present in the room. Two examples of *tua*, addressing the deceased, from this text are given in (139) and (140) below.

- (139) *airoo! kasian! ma bait hoo saa? naa na-mena =te, hoo*  
*airoo kasian ma baiti hoo saa? naa na-mena =te hoo*  
 oh! pity! and actually 2SG something 0DEM 3-sick\U =SUB 2SG  
*mu-toon =kai he hai mi-hiin tua, nene!*  
*mu-tona =kai he hai mi-hini tua nene*  
 2SG-tell\M =1PX.ACC IRR 1PX 1PX/2PL-know\M ADDR grandma  
 ‘Oh! Pity! And you had something that was sick and you told us so we  
 knew. Oh, Grandma!’ 130823-8, 4.44

- (140) *airoo! benu?! ma t-bee? =te oke? =te ?-reun*  
*airoo benu? ma t-be?e =te oke? =te ?-renu*  
 oh! goodness! and 1PI-stay.awake\M =SUB after.that 1SG-order\M  
*=koo =fa he m-tupa =te, ka= m-roim =fa, tua!*  
*=koo =fa he m-tupa =te ka= m-romi =fa tua*  
 =2SG.ACC =NEG IRR 1PX/2-sleep\U =SUB NEG= 1PX/2-like\M =NEG ADDR  
 ‘Oh! Goodness! And when we stayed up I then told you to sleep, but you  
 didn’t want to!’ 130823-8, 5.22

The word *tua* alone constitutes an acceptable conversational turn, in which case it merely indicates that the speaker is listening, or to give an affirmative answer to a question. In such situations it can often be glossed ‘yes’ or ‘OK’. Two examples are given in (141) below.

- (141) Asking about the *biku* curse: 120923-1 
- a.  $\alpha$ : *Dad, the person who casts the biku curse.* 8.37
- b. *Does s/he proclaim it to spirits in the land? Or what does s/he proclaim it to?* 8.44
- c. *So that the biku curse takes effect?* 8.48
- d.  $\beta$ : *m-ak nehh, on karu he on moa- mu-taan =kau*  
 1PX/2-say IRR.LOC if IRR IRR.LOC 2SG-ask =1SG.ACC  
*n-ok re? biku, f̄ara biikgw=ii?*  
 3-with TOP curse method curse=1DET  
 ‘So you’re asking me about the *biku* curse, the method by which the *biku* curse is cast?’ 8.51
- e.  $\alpha$ : *tua.*  
 ‘Yes.’ 8.55
- f.  $\beta$ : *biku bukan na-tona=n paah=ii.*  
 curse NEG 3-tell=PL country=1DET  
 ‘A *biku* curse is not proclaimed to the (spirits in the) land.’ 8.56
- g.  $\alpha$ : *tua.*  
 ‘OK’ 8.58
- h.  $\beta$ : *a|n-moo?d̄=ee n-ok hau, papa!*  
 3-do=3SG.ACC 3-with spell dad  
 ‘It’s done with a spell, dad!’ 8.59

If someone else has asked the narrator to tell a particular story, *tua* can be used by the narrator at the very beginning of the story to acknowledge the other speaker’s instruction and begin their monologue. Two examples are given in (142) and (143) below. In each example the narrator has been instructed by someone else to begin.

- (142) *au kaan-k=ii bi Oma, tua.*  
*au kana-k=ii bi Oma tua*  
 1SG name-3PL/1GEN=1DET Ms. Oma ADDR  
 ‘My name is Oma.’ 120715-2, 0.01 

- (143) *re? ahh uab uun?=ein nai tua.*  
*re? uaba unu?=ein nai tua.*  
 REL speech past=PL already ADDR.  
 ‘So (I’ll tell) some old stories.’ 120715-3, 0.07 🔊

In monologues *tua* commonly occurs at the end of a story or speech to indicate that the monologue is over. Two examples are given in (144) and (145) below. Example (145) is a typical high-level discourse closure.

- (144) *hai aa?-t=ii na-m-soup =ma n-heun-?=oo-n,*  
*hai a?a-t=ii na-m-sopu =ma n-henu-?=oo-n,*  
 1PX poetry-NML=1DET 3-STAT-finish\M =and 3-fill\M-TR=REFL-3SG.GEN  
*on naan nai, tua.*  
*on naan nai, tua*  
 IRR.LOC 2DEM already ADDR  
 ‘Our poetry is now finished and complete like that.’ 130825-3, 2.35 🔊

- (145) *on re? naan, tua.*  
 like TOP 2DEM ADDR  
 ‘That’s how it is.’ 120715-1, 1.31 🔊

The use of *tua* at the end of monologues is a part of the more general function of this particle to mark the end of a conversational turn, after which others are free to contribute to the conversation. Two examples are given in (146) and (147) below. In (146) below speaker- $\alpha$  and speaker- $\beta$  are the main participants in the conversation. In (146a) speaker- $\alpha$  makes a statement. Speaker- $\beta$  then expresses his interest in this statement with an exclamation in (146b). However, speaker- $\gamma$  interjects but ends his statement with *tua*, thus indicating that speaker- $\alpha$  and speaker- $\beta$  are free to resume their conversation.

- (146) Talking about farming: 130909-6 🔊
- a.  $\alpha$ : *n-hetu uutn=ii =t, ees ka= bisa =fa.*  
*n-hetu utan=ii =te esa ka= bisa =fa*  
 3-pick\U vegetables=1DET =SUB COP NEG= can =NEG  
 ‘Picking vegetables, (he) can’t even do that.’ 2.42
- b.  $\beta$ : *Hau bah!*  
 ‘Yes, indeed!’ 2.44

- c.  $\gamma$ : *n-pea =t na-ʔkoroʔ bian, tua.*  
 n-peo =te na-ʔkoroʔ bian tua  
 3-talk =SUB 3-hide\ʔ other ADDR  
 ‘(He) talked (about it) and hid others.’ 2.44
- d.  $\beta$ : *ahh baiʔ Tobias n-ak, na-ʔkoroʔ bian, haa!*  
 baʔi Tobias n-ak na-ʔkoroʔ bian  
 PF Tobias 3-say 3-hide\ʔ other  
 ‘Grandfather Tobias said he hid others.’ 2.45

In example (147) below speaker- $\alpha$  is collecting metadata. This metadata consists of two questions: the narrator’s name and where he comes from. In (147a) speaker- $\alpha$  asks the first question and also addresses the narrator as *papa* ‘dad’ to express politeness. In (147c) speaker- $\alpha$  ends the second question with *tua*, indicating that he does not intend to ask more questions. The collection of metadata is over and speaker- $\beta$  can begin his story.

- (147) Collecting metadata: 120923-1 
- a.  $\alpha$ : *papa, hoo kaan-m=ii sekau, papa?*  
 papa hoo kana-m=ii sekau papa  
 dad 2SG name-1PX/2GEN=1DET who dad  
 ‘Dad, what’s your name, dad?’ 0.01
- b.  $\beta$ : *au kaan-k=ii Melkias Mnaʔo.*  
 au kana-k=ii Melkias Mnaʔo  
 1SG name-3PL/1GEN=1DET Melchias Mna’o  
 ‘My name is Melchias Mna’o.’ 0.03
- c.  $\alpha$ : *hoo mu-ʔko mee, tua.*  
 2SG 2SG-ABL where ADDR  
 ‘Where are you from?’ 0.04
- d.  $\beta$ : *au u-ʔko Binoni Aufmeʔe, desa dua.*  
 au 1SG-ABL Binoni Aufme’e village two  
 ‘I’m from Binoni Aufme’e, village number two.’ 0.08

The particle *tua* is also used to take leave of someone. In Amaras culture it is rude to pass by someone and not speak to them. Silence towards another person is interpreted as a sign of a damaged relationship or anger, which is considered dangerous. As a result, people coming across one another during everyday activities are socially obliged to make small talk. Such small talk typically involves

asking questions such as where the other person is going or where they are coming from. Two typical small talk questions and possible answers are given in (148) and (149) below.

- (148) a. *hoo m-nao on mee?*  
 2SG 1PX/2-go IRR.LOC where  
 ‘Where are you going?’
- b. *(au) ?-nao on rene.*  
 1SG 1SG-nao IRR.LOC field  
 ‘I’m going to my field.’
- (149) a. *hoo m-o?ka mee?*  
 2SG 1PX/2-ABL where  
 ‘Where have you come from?’
- b. *(au) ?-o?ka ata nee.*  
 1SG 1SG-ABL up 3DEM  
 ‘(I’ve come) from up there.’

In Amarasi society the cultural imperative to interact in this way is so strong that speakers will yell out to one another across valleys or through the bush if they are aware that someone else is present. If the bush is so thick, or the distance so great that the location of the other person cannot be pinpointed exactly, speakers will call out (Amarasi *n-koa?* ‘whoop, yell a sound (without words)’). Similarly, when going past someone at speed on a motorbike or in a car, honking the horn is sufficient social interaction, though a comment is considered even more polite.

Interactions such as those in (148) and (149) do not occur on their own. Once someone has made small talk, they need strategies for ending the interaction to carry on whatever activity they were doing or to continue on their way.

It is in this context that the particle *tua* most often occurs in day-to-day use. By using the particle *tua* the speaker politely acknowledges that they have interacted and that this interaction is potentially complete.

A sample of the most common leave-taking phrases are given in (150)–(153) below. The usual – and sufficient – response to all such leave-taking phrases is the word *tua* by itself. Any of these phrases constitutes a sufficient social interaction on its own.

- (150) Passing a stationary person:                   (151) Returning home:
- au* ?-koongw=een,     ***tua***.                    *au* ?-faanɕ=een,     ***tua***.  
*au* ?-kono=ena     tua                            *au* ?-fani=ena     tua  
 1SG 1SG-pass\M=INCEP ADDR                1SG 1SG-back\M=INCEP ADDR  
 ‘I’ll keep going now.’                            ‘I’m going to head back now.’
- (152) Continuing after conversation:           (153) Overtaking (e.g. on motorbike):
- au* ?-naagw=een,     ***tua***.                    *hai* mi-huun,     ***tua***.  
*au* ?-nao=ena     tua                            *hai* mi-hunu     tua  
 1SG 1SG-go\M=INCEP ADDR                1PX 1PX/2PL-first\M ADDR  
 ‘I’ll get going again.’                            ‘We’re going on ahead.’

The particle *tua* does not co-occur with discourse U-forms. Not only is *tua* unattested with discourse U-forms, it is infelicitous with them. Every possible way of saying ‘I don’t know’ in Kotos Amarasi with each combination of  $\pm$ metathesis and  $\pm$ *tua* is given in (154) below.

Of these, native speakers consider (154a) and (154b) normal, with (154a) being more polite. Native speakers judge example (154c) to be even more respectful or polite while (154d) – with both a U-form and *tua* – is considered funny.

- (154) a. *au* ka= u-hiin     =fa.  
           *au* ka= u-hini     =fa  
           1SG NEG= 1SG-know\M =NEG
- b. *au* ka= u-hini     =f.  
           *au* ka= u-hini     =fa  
           1SG NEG= 1SG-know\U =NEG
- c. *au* ka= u-hiin     =fa, *tua*.  
           *au* ka= u-hini     =fa *tua*  
           1SG NEG= 1SG-know\M =NEG ADDR
- d. # *au* ka= u-hini     =f, *tua*.  
           *au* ka= u-hini     =fa *tua*  
           1SG NEG= 1SG-know\U =NEG ADDR  
           ‘I don’t know.’

The inability of *tua* to co-occur felicitously with U-forms is explained by a clash in the functions of these two discourse resources. One part of the function of *tua* is to politely acknowledge the addressee as an interlocutor, while the other



part of its function is to indicate that the interaction is potentially complete. A U-form, on the other hand, explicitly marks a lack of resolution and the lack of completion in a conversation. The combination of potential completion (*tua*) and explicit lack of resolution/completion (U-form) cannot be sensibly combined in Amarasi.

#### 7.10.4.2 Question particles

There are three common tag question particles in Amarasi, given in Table 7.7 below. The tag question particles *oo* and *kaah* invite a response and combine naturally with discourse U-forms which signal lack of resolution.

Table 7.7: Amarasi tag question particles

| Particle    | Usage                              |
|-------------|------------------------------------|
| <i>aa</i>   | ‘I think this’                     |
| <i>oo</i>   | ‘You should do this.’              |
| <i>kaah</i> | ‘I think this, what do you think?’ |

The particle *oo* is often used as the language of power to obligate the addressee to respond and confirm or comply with the expectation of the speaker, thus resolving any U-form with which it occurred.

The particle *kaah* marks that the speaker is not sure of the content of their question and invites the addressee to correct, confirm, or deny the assumption, and thus resolve any U-form with which *kaah* occurred. The particle *aa* is often used in rhetorical questions to which the addressee is not expected to respond. An example is given in (155).

- (155) *mama, au huutgw=ii ma?tane? aa?*  
 mum 1SG louse=1DET excessive Q  
 ‘Mum, I’ve got a lot of lice, haven’t I?’ 130914-3, 1.03 

The particle *aa* cannot be felicitously combined with a direct question when the speaker is genuinely unsure about the answer. This is the case no matter whether a U-form or M-form is used. This is shown in (156) below.

- (156) Asking if someone drinks alcohol: elicit. 13/06/16 p.15
- a. # *hoo m-inu*, *aa?*  
     *hoo m-inu*      *aa*  
     2SG 1PX/2-drink\U Q  
     ‘You’ll drink, right?’
- b. # *hoo m-iun*, *aa?*  
     *hoo m-inu*      *aa*  
     2SG 1PX/2-drink\M Q  
     ‘You’ll drink, right?’

When used in direct questions where the speaker genuinely wants an answer, the tag question particles *oo* and *kaah* combine naturally with a U-form, as shown in (157a) and (157c) below, but are not natural with an M-form, as shown in (157b) and (157d) below.<sup>16</sup>

- (157) Asking if someone drinks alcohol: elicit. 13/06/16 p.15
- a. *hoo m-inu*, *oo?*  
     *hoo m-inu*      *oo*  
     2SG 1PX/2-drink\U Q  
     ‘You’ll drink, won’t you?’
- b. # *hoo m-iun*, *oo?*  
     *hoo m-inu*      *oo*  
     2SG 1PX/2-drink\M Q  
     ‘You’ll drink, won’t you?’
- c. *hoo m-inu*, *kaah?*  
     *hoo m-inu*      *kaah*  
     2SG 1PX/2-drink\U NEG  
     ‘You’ll drink, won’t you?’
- d. # *hoo m-iun*, *kaah?*  
     *hoo m-inu*      *kaah*  
     2SG 1PX/2-drink\M NEG  
     ‘You’ll drink, won’t you?’

A discourse U-form combines naturally with the tag question particles *oo* and *kaah*. This is because a U-form signals lack of resolution, the particle *oo* places

<sup>16</sup>The form *kaah* is also a negator. Its use as a tag question can be compared with English examples such as ‘You drink, *don’t* you?’

an obligation on the addressee to respond and thus resolve the U-form, and the particle *kaah* invites the addressee to answer and thus resolve the U-form.

### 7.10.5 Summary

U-forms are used in conversation to maintain interaction between speakers. A speaker can use a U-form to signal a lack of resolution. If the same speaker does not provide a resolution, it becomes incumbent upon the addressee to provide a resolution. Question/answer pairs are one subtype of this function, with questions being posed in the U-form and answered in the M-form.

Discourse U-forms combine naturally with the question particles *oo* and *kaah*, which both require a response from the addressee, but these particles do not combine naturally with M-forms in direct questions. Because U-forms mark a lack of resolution, they do not combine with the particle *tua*, which indicates that the interaction is potentially complete.

## 7.11 Discourse-driven metathesis in Ro'is Amarasi

There are a number of differences between Ro'is Amarasi and Kotos Amarasi regarding discourse metathesis. A full discussion of Ro'is Amarasi is beyond the scope of this book and I provide here only a description and overview of some of the most salient points of difference, without a consistent attempt to analyse or explain these differences. Additionally, the observations in this section must be taken as preliminary as I have spent much less time in Ro'is speaking areas compared with Kotos speaking areas. The main differences I have observed include the presence of M-forms with final consonant clusters (§7.11.1), the use of M-forms before connectors (§7.11.2) and the use of U-forms in negation (§7.11.3).

### 7.11.1 M-forms with final consonant clusters

Certain consonant-final words are eligible to undergo metathesis with a resulting final consonant cluster in Ro'is Amarasi. As a result such consonant-final words can have discourse driven U-forms and M-forms in Ro'is Amarasi, with U-forms marking lack of resolution in a way which appears to be very similar to that of Kotos Amarasi as described in the previous sections.

In texts from my oldest speaker from Batuna – Tonci Niti who is about 90 years old<sup>17</sup> – stems with a final consonant do not take U-forms to mark lack of

---

<sup>17</sup>Tonci Niti learnt both some Dutch and some Japanese at school, indicating that he was attend-

resolution as consistently as in texts from younger speakers. Thus, the use of U-forms for certain consonant-final stems as described in this section may be a recent development in Ro'is Amarasi.

### 7.11.1.1 Verbs

For verbs, only stems with a word-final /n/ (i.e. CVn#) are attested with CC-final M-forms in my Ro'is corpus. CC-final M-forms are further only permitted for /n/ final verbs which also fulfil at least one of the following criteria: (1) the final vowel is /a/, (2) the final vowel is identical to the penultimate vowel, or (3) the penultimate consonant is also /n/. When these phonotactic criteria are fulfilled, CVn# final verbs have U-forms with discourse functions which appear to be similar to those described for Kotos Amarasi in this chapter.

A number of examples are given below. Example (158) is a kind of dependent coordination (§7.6) in which the U-form *n-kono=n* 'continue' encodes an activity which is resolved by that encoded by the M-form *n-tuup=n* 'sleep'. The final consonant of the CC-final M-form is the plural enclitic =n and this is common in my Ro'is database.

- (158) *oka =te ahh nu n-nao=n n-kono=n en Si'uf,*  
 after.that IRR 3-go=PL 3-keep\U=PL IRR.LOC Si'uf  
*nu n-tuup=n ek nae =te, n-tuup=n ek aadꞑ=ee n-peen*  
 IRR 3-sleep\M LOC 3DEM =SUB 3-sleep\M=PL LOC 1DEM=3DET 3-not.want  
 'After that they wanted to continue on to Si'uf, they wanted to sleep there,  
 they didn't want to sleep here.' R0-170830-4, 4.03 🗣️

In (159) below, the U-form *na-peʔan* 'raise, bring up, cultivate' introduces two verbs that specify this concept further and is resolved by the M-forms of the parallel pair *na-riikn na-peaʔn*.

- (159) *uis aafgw=ii, hiin nai? na-peʔan, na-mōini-b, na-toro-b, na-riikn,*  
 usif afu=ii hini nai? na-peʔan, na-moni-b, na-toro-b, na-rikin,  
 king ground=1DET 3SG then 3-raise\U 3-live-TR 3-sprout-TR 3-raise\M  
*na-peaʔn.*  
 na-peaʔn.  
 3-raise\M  
 'The lord of earth (God), he raised (life), he gave life [doublet], and raised  
 (it up) [doublet].' R0-170829-1, 12.18 🗣️

---

ing school prior to and during the second world war period, thus verifying his claim to be about 90 years old.

An example of the parallel pair *na-rikin na-peʔan* ‘raise’ with an initial U-form and CC-final M-form is given in (160) below. This is an example of U-forms and M-forms being used to express poetic parallelism (§7.8).

- (160) *karna Uisneengw=ii, eseʔ na-rikin na-peaʔn*  
*karna Uisneno=ii ees heʔ na-rikin na-peʔan*  
 because God=1DET one REL 3-raise\U 3-raise\M  
 ‘Because God is the one who raised up (life).’ R0-170829-1, 5.34 

### 7.11.1.2 Nouns

As discussed in §4.2.3.1 certain Ro'is Amarasi nouns have two M-forms: one formed by metathesis with deletion of the final consonant and one with retention of the final consonant. An example is *ranan* ‘road’, with the M-form *raan* and CC-final M-form *raann*.

Nouns which are attested with such CC-final M-forms in my data fulfil either set of criteria given in (161a) or (161b). More data on Ro'is Amarasi will probably lead to changes and refinements of these criteria.<sup>18</sup>

- (161) Nouns with CC-final M-forms in Ro'is Amarasi
- a. Option 1:
    - i. The penultimate and final consonants are both nasals
  - b. Option 2:
    - i. The penultimate consonant is /n/ or /r/
    - ii. The final consonant is not /ʔ/ or /h/
    - iii. The final consonant is not a non-nasal suffix
    - iv. The final vowel is either /a/ or identical to the penultimate vowel

For nouns which fit either set of criteria in (161), the normal M-form (with deletion of the final consonant) is used as a construct form in the same way as in Kotos Amarasi, as discussed in Chapter 6, while the other forms appear to be used to mark discourse structures. That is, in Ro'is Amarasi a U-form of a noun which fits the criteria in (161) marks an unresolved situation while a CC-final M-form marks a resolved situation.

<sup>18</sup>Every Ro'is noun which has been attested with a CC-final M-form in my current data is given in Table 4.7 on page 170, though this table does not include forms which are consonant final due to attachment of a nasal suffix.

This also means that the CC-final M-forms of such nouns are usually the default forms which are given as the citation forms and in simple declarative clauses. Two examples of nouns with CC-final M-forms in simple declarative clauses are given in (162) and (163) below.

- (162) *ees n-reek nu n-nao n-koa?=siin nu na-nena-?=siin preent.*  
*esa n-reka nu n-nao n-koa?=sini nu na-nena-?=sini prenat*  
 one 3-order IRR 3-go 3-call=3PL IRR 3\TR-listen-TR=3PL instruction  
 ‘he ordered (him) to go call them to have them listen to instructions.’  
 R0-170830-5, 2.24 ◀▶

- (163) *hiin uab-n sefara umum neme n-tua k he? ai*  
*hini uaba-n sefara umum nema n-tua ek he? ai*  
 3SG speech\M-3SG.GEN manner general 3\come 3-finish LOC REL 1DEM  
 ‘Its story finishes in a general manner here.’ R0-170830-1, 5.16 ◀▶

An example of the U-form of such a noun marking lack of resolution is given in (164) below. This is an example of tail-head linkage (§7.7). The U-form tail *ranan* ‘road’ in (164a) is resolved by the M-form in (164b) which then introduces an unexpected event in (164c).

- (164) A female leader supervises road construction: R0-170827-3 ◀▶
- a. *n-nao en preent=ee nu na-taah mepu ranan.*  
 3-go IRR.LOC government=3DET IRR 3-answer work road\U  
 ‘(She should) go to the government to report on the road work,’ 3.14
- b. *n-nao n-toup mepu raann.*  
*n-nao n-topu mepu ranan*  
 3-go 3-receive work road\M  
 ‘(She should) go and get road work.’ 3.18
- c. *nai =te, hiin moonɔ́=ii ees ka-nao-t=ii*  
 and.then 3SG husband=1DET COP NML-go-NML=1DET  
 ‘And then her husband was the one who went (*lit.* the goer)’ 3.20

Two examples of CC-final nominal M-forms in parallelism are given in (165) and (166) below. Each of these examples consists of two juxtaposed noun phrases each of which encodes part of a single entity construed as a complete whole. In each case the initial U-form is resolved by the following CC-final M-form.

- (165) *nai? na-snasa-b urun ainn =ama,*  
*nai? na-snasa-b uran anin =ma,*  
 then 3-stop-TR rain\U wind\M =and  
 ‘Then (he) stopped the rain and the wind...’ R0-170829-1, 14.18 🔊
- (166) *nai? ka-moe? ahh neno tunu-n paah piin-n*  
*nai? ka-mo?e-t neno tuna-n paha pina-n*  
 then NML-make sky top\U-3SG.GEN world below\M-3SG.GEN  
 ‘He (God) was the maker of heaven and earth.’ R0-170827-1, 3.09 🔊

### 7.11.2 Dependent coordination

U-forms are not obligatory in Ro'is Amarasi before the connectors *=ma* and *=te* when the event preceding the connector is dependent on the next event for its resolution. An example each of an M-form before *=te* and *=ma* are given in (167) and (168) respectively below.

- (167) *tapi karu n-mama =mae?, ahh n-meup =te, en na-peeh.*  
*tapi karu n-mama =mae? n-mepe =te en na-pehe*  
 but if 3-chew =NEG 3-work\M =SUB like 3-lazy  
 ‘But if they don’t chew betel nut, then when they work it’s like they’re lazy’  
 R0-170824-1, 1.46 🔊
- (168) *lalu, siin n-feen =ma n-nao =heen*  
*lalu sini n-fena =ma n-nao =hena*  
 then 3PL 3-get.up =PROP 3-go =INCEP  
 ‘Then they got up and left.’ R0-170820-1, 3.38 🔊

In fact, U-forms are extremely rare before the connectors *=ma* and *=te* in my Ro'is Amarasi corpus, with only about a dozen examples out of more than 500 examples of *=ma* and *=te*.

When a CVC# final stem occurs before a connector, the connector usually takes its vowel-initial allomorph *=ama* or *=ate* in Ro'is Amarasi (§3.7.3), except when the final consonant of the host is a glottal stop /ʔ/. While in Kotos Amarasi these vowel-initial allomorphs optionally trigger phonologically conditioned metathesis (Chapter 5) in Ro'is Amarasi these vowel-initial allomorphs *obligatorily* trigger metathesis. Examples of CVC# final stems before connectors in Ro'is Amarasi are given in (169)–(171) below.

## 7 Discourse-driven metathesis

- (169) *ees oka =te, n-ma-roim=n =ate n-matsao=n karna,*  
*esa oka =te, n-ma-romi=n =te n-matsao=n karna,*  
 one then 3-RECP-like\̄M=PL =SUB 3-marry=PL because  
 ‘then if they like one another, they get married because...’ R0-170830-4,  
 7.15 🔊
- (170) *oke =te, a|n-hook=n =ama n-tofo=n*  
*oke =te n-hoka=n =ma n-tofa=n*  
 then 3-call.up\̄M=PL =and 3-weed=PL  
 ‘Then (people) were called up and (they) weeded.’ R0-170902-1, 2.04 🔊
- (171) *Uisneno hiin preent =am hiin k̄abin*  
*Uisneno hini prenat =ma hini kabin*  
 God 3SG instruction\̄M =and 3SG word  
 ‘God’s words and instructions.’ R0-170829-1, 13.10 🔊

### 7.11.3 Negation

The normal negation strategy in Ro’is Amarasi is with *=mae?*, which occurs after the negated predicate.<sup>19</sup> Vowel final stems directly followed by *=mae?* are only attested in the U-form in my Ro’is Amarasi data. Examples are given in (172)–(174) below.

- (172) *n-tui na-hini =mae?, n-rees na-hini =mae?*  
 3-write 3-know\U =NEG 3-read 3-know\U =NEG  
 ‘He didn’t know how to read or write.’ R0-170820-2, 1.12 🔊
- (173) *mese? hiin na-tona =mae?*  
 but 3SG 3-tell\U =NEG  
 ‘But he didn’t tell (us).’ R0-170820-1, 8.24 🔊
- (174) *au ku-sboo =t, berarti au bisa ku-ha mae?*  
 1SG 1SG-smoke =SUB meaning 1SG can 1SG-eat\U =NEG  
 ‘If I smoke, that means I can’t (afford to) eat.’ R0-170821-1, 14.32 🔊

However, when a stem with a final consonant other than a glottal stop /ʔ/ is followed by *=mae?*, the negator takes a vowel-initial form *=amae?*, thus triggering automatic metathesis on the preceding word (Chapter 5). Two examples are given in (175) and (176) below.

<sup>19</sup>The proclitic *ka=* also occasionally occurs as a negator in Ro’is Amarasi. I have nine examples of *ka=* in my Ro’is corpus against 99 examples of *=mae?*



- (175) *ma he? uun? = ui t-iit soi?-t = amae?*  
*ma he? unu? = ii t-ita so?i-t = mae?*  
 and REL long.ago=1DET 0-exist count\̄M-NML =NEG  
 ‘But long ago there wasn’t any counting.’ R0-170917-1, 3.22 🔊
- (176) *na-baar = n = am neem = n = amae?*  
*na-bara = n = ma nema = n = mae?*  
 3-stay=PL =and 3\come\̄M=PL =NEG  
 ‘(they) stayed and didn’t come back.’ R0-170917-1, 8-16 🔊

## 7.12 Conclusion

The different combinations of M-forms and discourse U-forms which are found in Amarasi are summarised in Table 7.8. Metathesis in Amarasi is a morphological device used to signal whether a situation, event, or communicative act is resolved or not. U-forms are used to signal a lack of resolution, with more information being required to achieve such resolution.

Table 7.8: Summary of U-form and M-form combinations<sup>†</sup>

|     | decl. clause | Dep. Coord. | THL    | Poetry | Chiasmus | Q/A     | Conv.     |
|-----|--------------|-------------|--------|--------|----------|---------|-----------|
| MM  | ✓            |             |        | §7.8   |          | §7.10.1 |           |
| UM  |              | §7.6        |        | §7.8   |          | §7.10.1 | §7.10.2   |
| UU  |              |             |        |        |          |         |           |
| MU  |              |             |        |        |          |         | (§7.10.2) |
| MMM | ✓            |             |        |        |          |         | §7.10.2   |
| UMM |              |             | §7.7.2 |        |          |         |           |
| UUM |              |             | §7.7.3 |        |          |         | §7.10.2   |
| MUM |              |             | §7.7.1 |        | §7.9     |         |           |
| UMU |              |             |        |        |          |         |           |
| MMU |              |             |        |        |          |         |           |
| MUU |              |             |        |        |          |         |           |
| UUU |              |             |        |        |          |         | (§7.10.2) |

<sup>†</sup> decl. clause = declarative clause, Dep. Coord. = Dependent Coordination, THL = Tail-head linkage, Q/A = question-answer pairs, Conv. = Conversation

Table 7.8 shows that nearly all combinations of an M-form and a discourse U-form have an M-form as the final element. U-forms are canonically resolved by

## 7 *Discourse-driven metathesis*

an M-form. This is seen most clearly in tail-head linkage (§7.7), question-answer pairs (§7.10), and poetic parallelisms (§7.8) in all of which U-forms are obligatorily resolved by M-forms. It is also seen in dependent coordination (§7.6) and chiasmus (§7.9) in which U-forms are usually resolved by M-forms.

A discourse U-form entails the presence of a corresponding M-form somewhere in the discourse. The use of a U-form obliges the speaker or other discourse participants to supply an M-form to complete the discourse structure in which both occur. At the discourse level, U-forms and M-forms comprise a parallel and complementary pair of morphological forms; they are a dyadic set, with each form being one half of a whole. The complementary and parallel nature of discourse U-forms and M-forms in Amarasi is represented in Figure 7.2.

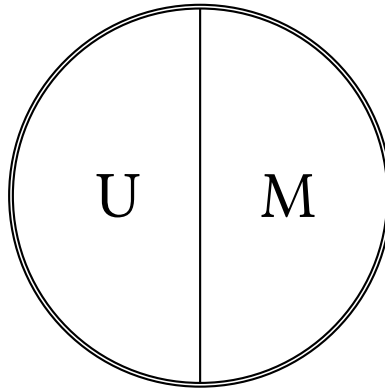

Figure 7.2: Amarasi discourse metathesis

## 8 Contributions and conclusions

### 8.1 Metathesis in linguistics

Previous works on metathesis have mainly viewed the phenomenon through a phonological lens. This has led to much useful development of phonological models and analyses which can account for metathesis. In this work I have gone beyond a phonological account, and have provided perhaps the first detailed study of both the form *and* function of metathesis in a single language, Amarasi.

Like some other languages with synchronic metathesis, such as Rotuman, Leti, and Helong (see §2.2.3), metathesis in Amarasi is not a unitary phenomenon. Instead, we can identify three kinds of metathesis: one kind of phonologically conditioned metathesis and two kinds of morphological metathesis, one with a syntactic function and one with a discourse function.

In the greater Timor region (and more widely) metathesis is often used as a construct form marking attributive modification. Other languages in which metathesis is a construct form include Rotuman, Leti, Roma, Mambae, and Helong (§2.2.3). The large number of languages which have the same function for metathesis is probably connected with the development of consonant-vowel metathesis.

Metathesis with a discourse function has been reported for Luang, in which metathesis of verbs occurs at certain points in the narrative structure, namely: “Known information and mainline event information, especially at peak points of the story.” (Taber & Taber 2015: 24). However, under the analysis of Taber & Taber (2015), metathesis in Luang is a phonological process which occurs to join words into a single rhythm unit; a phrase with only one stressed syllable.

Metathesis in Kwara’ae, in which both forms are used in different speech registers, could be construed as a kind of discourse metathesis. Again, however, metathesis in Kwara’ae can be successfully analysed as a result of the stress rules of the language (Heinz 2004).

Neither syntactic nor discourse metathesis in Amarasi can be reduced to being the accidental side effect of some other phonological process (see §4.4.2). Instead, the two generalisations which allow us to account for all the different phonological processes found in the formation of M-forms are an obligatory CVCVC foot (with empty C-slots) and a rule of consonant-vowel metathesis;  $CV \rightarrow VC / \acute{V} \_ .$

## 8 Contributions and conclusions

Blevins & Garrett (1998) showed how a process of synchronic metathesis can develop through a number of phonetically natural steps (see §2.4.2) and in §4.5 I showed that there is evidence that Amarasi developed its metathesis according to the pathway labelled *compensatory metathesis* by Blevins & Garrett (1998); this is a kind of metathesis which originally arose in certain prosodically conditioned environments.

Metathesis in Amarasi is no longer restricted these environments. Unlike Lunag or Kwara'ae, metathesis in Amarasi has escaped from any original phonological constraints and now runs throughout the whole language. From the occurrence of isolated words where nouns are cited in the U-form and verbs in the M-form, right up to complex clause chaining phenomena such as tail-head linkage, the single phenomenon the analyst encounters time and time again is metathesis.

Nearly all areas of Amarasi grammar interact with metathesis. In Chapter 4 I posited that the creation of a morphological metathesis paradigm was part of the motivation for the imposition of the CVCVC foot to all words of the language in order to provide the necessary machinery for consonant-vowel metathesis to operate, and thereby allow each word to fill both cells of the morphological paradigm. In this way metathesis has taken over the phonotactics of Amarasi and become the central organising principle by which words are structured.

Phonotactics is not the only linguistic sub-domain to have been invaded by metathesis. In Chapter 5 I showed that metathesis interacts with prosodic structures by marking a clear phonological boundary between two prosodic words.

In Chapter 6 I showed that it is metathesis which marks the structure of the noun and verb phrase by marking the presence of an attributive modifier which belongs to the same word class as the head of a phrase.

In Chapter 7 I showed that in narratives it is metathesis which advances the plot through tail-head linkage and dependent coordination. In multi-speaker discourse, metathesis is the social glue which binds the conversation together. Unmetathesised and metathesised forms are employed as question-answer pairs, and signal the end of a conversational turn, thereby carrying forward interactions between speakers.

Metathesis in Amarasi is not merely an epiphenomenon or exotic curiosity. Rather, it is a central feature around which other linguistic structures are organised. In addition to being the key which unlocks the structure and genius of the language, Amarasi metathesis is also the linguistic instantiation of two pervasive ethnographic traits of the Amarasi people: identity and parallelism.

## 8.2 Metathesis and identity

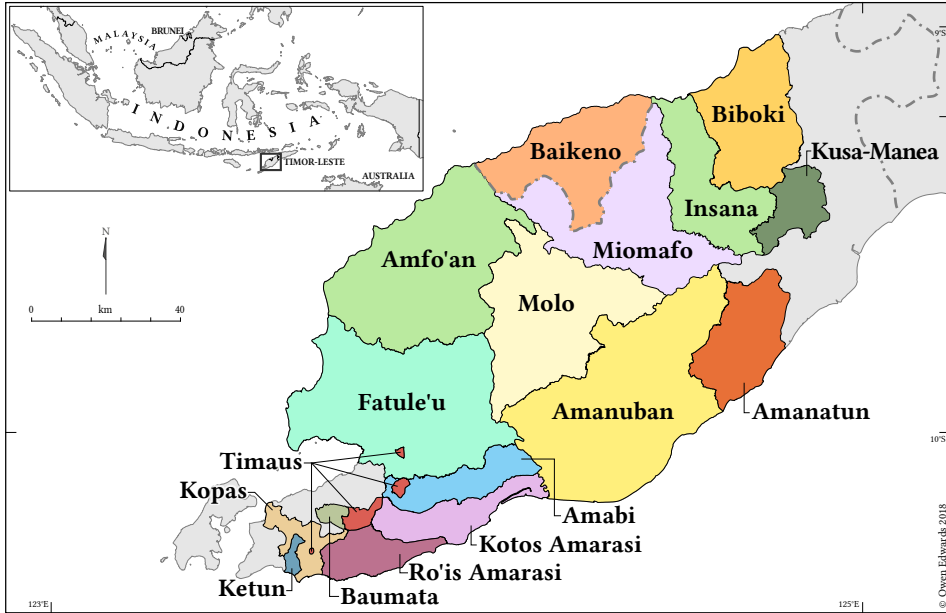

Figure 8.1: Self-identified varieties of Meto

It is well known that language is frequently employed as a marker of identity (Milroy 1982; Edwards 2009; Fishman & García 2010). This is also the case in western Timor in which the four main ethnic identities are delineated according to language: Rote, Helong, Tetun, and the Atoni, who speak Meto.<sup>1</sup>

Within each of these groups, further identities also exist. While the Atoni (Meto speakers) self-identify as a single cultural and linguistic group, they also acknowledge internal cultural and linguistic differences between groups. The labels used for the prescriptively defined different groups, as given in Figure 8.1, correspond almost exactly to the historic kingdoms of the region.

One kind of cultural difference found between groups is different weaving traditions. An example of Amarasi cloth, Amfo'an cloth, and Fatule'u cloth is given in Figure 8.2 below. Further differences in weaving are also found between individual hamlets. Thus, the use of blue lines between the geometric maroon pat-

<sup>1</sup>Meto speakers refer to themselves in full as *atoin paah meto?* or *atoni paah meto?* 'people of the dry land' (Cunningham 1962: i; Schulte Nordholt 1971: 1). The term Atoni is from *atoni?* in Amarasi or *atoni* in other Meto varieties and means 'man, person'.

## 8 Contributions and conclusions

terns in Figure 8.2a is distinctive of Koro'oto hamlet while the hamlet of Ponain, for instance, mainly uses yellow lines.



Figure 8.2: Three types of Meto cloth

Another example of enacted identity can be found in the different methods employed to count corn, the traditional crop of western Timor. As reported by Grimes & Bani (2011), Kotos Amarasi counts corn in units of *rean*, with one *rean* being 400 cobs of corn. In the Tais Nonof variety of Amarasi, corn is counted by the *nifu* (thousand). In some other regions corn is counted by *kuda* (Indonesian for 'horse') with one *kuda* consisting of 80 cobs of corn.

Such differences are salient to the Atoni. When collecting data on Fatule'u I was accompanied by my main Amarasi consultant, Heronimus Bani (Roni). After I had collected a wordlist, Roni asked about cloth design in Fatule'u; what the different parts of the pattern were called, and what these patterns symbolised, in fact figure Figure 8.2c was taken by Roni. He also asked how corn was counted in Fatule'u and volunteered that in Amarasi corn was counted by *rean*.

The Atoni agree that they speak a single language: Meto. However, they also acknowledge that there are differences in how people speak in different places, differences which can often accumulate to such an extent that they seriously hinder communication.

In my experience, Atoni from different regions often talk in a mixture of Meto and Indonesian/Kupang Malay. Using Meto enables expression of their shared identity and the use of Indonesian/Kupang Malay enables effective communication. One or more speakers will also usually adapt their speech to perceived norms of their interlocutors.

The Atoni are aware to varying degrees of salient differences between different varieties of Meto. It is fairly common knowledge, for instance, that Amarasi has /r/ while other varieties have /l/.<sup>2</sup> Similarly, on a more local scale speakers of Kotos Amarasi and Ro'is Amarasi are aware of some differences between one another's speech, and when asked, my Kotos consultants would gleefully try to imitate Ro'is speech.

One obvious kind of linguistic difference between different varieties of Meto is lexical. A selection of lexemes in several varieties of Meto and other languages of western Timor is given in Table 8.1. Although the difference between Meto other languages is greater than that between individual varieties of Meto, the internal diversity of Meto is not insignificant.

Table 8.1: Lexical differences between languages of western Timor

|             | 'earth'        | 'thorn'        | 'mouse'      | 'red' <sup>†</sup> | 'big'           | 'dream'          |
|-------------|----------------|----------------|--------------|--------------------|-----------------|------------------|
| Amarasi     | <i>afu</i>     | <i>aika?</i>   | <i>knafo</i> | <i>me?e</i>        | <i>ko?u</i>     | <i>na-mnei</i>   |
| Amanuban    | <i>nain</i>    | <i>sakunat</i> | <i>nafo</i>  | <i>mee?</i>        | <i>?naek</i>    | <i>na-nae?</i>   |
| Amanatun    | <i>nain</i>    | <i>kasunat</i> | <i>nafo</i>  | <i>mee?</i>        | <i>?naek</i>    | <i>na-nae?</i>   |
| Fatule'u    | <i>afu</i>     |                | <i>ifo</i>   | <i>mtasa?</i>      | <i>?naek</i>    | <i>n-unmae?</i>  |
| Molo        | <i>naɟan</i>   | <i>katila?</i> | <i>ifo</i>   | <i>mtasa?</i>      | <i>?naek</i>    | <i>n-?unmae?</i> |
| Amfo'an     | <i>naiɟan</i>  | <i>kalila?</i> | <i>ifog</i>  | <i>mtasa?</i>      | <i>?naek</i>    | <i>na-smaan</i>  |
| Baikeno     | <i>naiɟaan</i> | <i>kalila?</i> | <i>bifo</i>  | <i>mee?</i>        | <i>?naek</i>    | <i>na-mnei</i>   |
| Timaus      | <i>afidɟ</i>   | <i>katila?</i> | <i>ifugw</i> | <i>mee?</i>        | <i>?naek</i>    | <i>n-mai</i>     |
| Kopas       | <i>afu</i>     | <i>katila?</i> | <i>ifo</i>   | <i>mee?</i>        | <i>?naek</i>    | <i>na-mnai</i>   |
| Kusa-Manea  | <i>nian</i>    | <i>tana?</i>   | <i>nafo</i>  | <i>nuti</i>        | <i>binai?</i>   | <i>na-mnei</i>   |
| Helong      | <i>dale</i>    | <i>duli?</i>   | <i>blaho</i> | <i>mea</i>         | <i>tene</i>     | <i>natloa</i>    |
| Lole (Rote) | <i>dae</i>     | <i>dilak</i>   | <i>lafo</i>  | <i>mbilas</i>      | <i>inahuu-k</i> | <i>me?i</i>      |
| Dela (Rote) | <i>rae</i>     | <i>manɟou?</i> | <i>lafo</i>  | <i>mbilas</i>      | <i>ine-?</i>    | <i>na-lamein</i> |
| Tetun       | <i>rai</i>     | <i>ktarak</i>  | <i>laho</i>  | <i>mean</i>        | <i>boo</i>      | <i>me?i</i>      |

<sup>†</sup> In Amarasi *mtasa?* means 'ripe' and *me?e mtasa?* 'maroon'.

<sup>2</sup>The situation is, in fact, more complex. Amabi and Kusa-Manea also have /r/ instead of /l/. Timaus has both /l/ and /r/ (the latter of which has developed from \*ɟ). These additional complexities do not enter into the popular discourse about differences.

## 8.2.1 Realisation of U-forms and M-forms

Another marker of linguistic identity among the Atoni is metathesis: different ways of realising U-forms and M-forms, different environments in which these forms are used and different functions of these forms. Some differences in the realisation of U-forms and M-forms between eight different varieties of Meto are given in Table 8.2, with identical forms indicated by identical colours.

Table 8.2: Variation in U-forms and M-forms<sup>†</sup>

|                    | 'three'     |              | 'dog'         |            | 'wood, tree'  |            | 'fire'       |           | 'day'         |                |  |
|--------------------|-------------|--------------|---------------|------------|---------------|------------|--------------|-----------|---------------|----------------|--|
|                    | U           | M            | U             | M          | U             | M          | U            | M         | U             | $\bar{M}$      |  |
| Kotos <sub>K</sub> | <i>tenu</i> | <i>teun</i>  | <i>asu</i>    | <i>aus</i> | <i>hau</i>    | <i>hau</i> | <i>ai</i>    | <i>ai</i> | <i>nenō</i>   | <i>neengw=</i> |  |
| Kotos <sub>F</sub> | <i>tenu</i> | <i>teun</i>  | <i>asu</i>    | <i>aus</i> | <i>hau</i>    | <i>hau</i> | <i>ai</i>    | <i>ai</i> | <i>nenō</i>   | <i>neong=</i>  |  |
| Ro'is <sub>S</sub> | <i>tenu</i> | <i>teun</i>  | <i>asu</i>    | <i>aus</i> | <i>hau</i>    | <i>hau</i> | <i>ai</i>    | <i>ai</i> | <i>nenō</i>   | <i>neenb=</i>  |  |
| Amanub.            | <i>tenu</i> | <i>teun</i>  | <i>asu</i>    | <i>aus</i> | <i>hau</i>    | <i>hau</i> | <i>ai</i>    | <i>ai</i> | <i>nenō</i>   | <i>neen=</i>   |  |
| Kualiin            | <i>tenu</i> | <i>teun</i>  | <i>asaw</i>   | <i>aus</i> | <i>hau</i>    | <i>hau</i> | <i>ai</i>    | <i>ai</i> | <i>nenaõ</i> | <i>neen=</i>   |  |
| Baikeno            | <i>tenu</i> | <i>teen</i>  | <i>asu</i>    | <i>aos</i> | <i>haub</i>   | <i>hau</i> | <i>aidz̃</i> | <i>ai</i> | <i>nenō</i>   | <i>neemb=</i>  |  |
| Amfo'an            | <i>tenu</i> | <i>teen</i>  | <i>asug</i>   | <i>asu</i> | <i>haug</i>   | <i>hau</i> | <i>aidz̃</i> | <i>ai</i> | <i>nenog</i>  | <i>neengw=</i> |  |
| Timaus             | <i>tenu</i> | <i>teenw</i> | <i>asidz̃</i> | <i>asu</i> | <i>haadz̃</i> | <i>hau</i> | <i>aar</i>   | <i>ai</i> | <i>nenugw</i> | <i>neengw=</i> |  |
| Fatule'u           | <i>tenu</i> | <i>teenw</i> | <i>asu</i>    | <i>aus</i> | <i>haub</i>   | <i>hau</i> | <i>aadz̃</i> | <i>ai</i> | <i>nenō</i>   | <i>neenb=</i>  |  |
| Kopas <sub>T</sub> | <i>tenu</i> | <i>teun</i>  | <i>asu</i>    | <i>aus</i> | <i>haag</i>   | <i>hau</i> | <i>aadz̃</i> | <i>ai</i> | <i>nenō</i>   | <i>neon=</i>   |  |
| Kopas <sub>U</sub> | <i>tenu</i> | <i>teenw</i> | <i>asu</i>    | <i>aus</i> | <i>haagw</i>  | <i>hau</i> | <i>aadz̃</i> | <i>ai</i> | <i>nenō</i>   |                |  |

<sup>†</sup> Kotos<sub>K</sub> = Kotos Amarasi from Koro'oto hamlet, Kotos<sub>F</sub> = Kotos Amarasi from Fo'asa' hamlet, Ro'is<sub>S</sub> = Ro'is Amarasi from Suit hamlet, Amanub. = Amanuban from Niki-niki, Kualiin = Amanuban from Kualin village, Amfo'an = Naitbelak Amfo'an from Ta'en hamlet, Fatule'u = Bineon-Koa' hamlet, Kopas<sub>T</sub> = Tuale'u hamlet, Kopas<sub>U</sub> = Usapisonba'i hamlet,

Table 8.2 shows that there is an extensive array of realisations for U-forms and M-forms. The four different processes which occur are: metathesis, consonant insertion, diphthongisation, and vowel shift or assimilation. Different combinations of these processes not only occur in different Meto varieties, but two particular varieties of Meto do not necessarily treat all words of the same phonotactic shape in the same way.

Nouns undergo metathesis in all (known) varieties before vowel-initial enclitics, but with or without insertion of different consonants (which occurs with or without assimilation of final /n/). A number of varieties mark U-forms ending in a vowel sequence by consonant insertion, though in different varieties different consonants are inserted and are accompanied by different degrees of



vowel assimilation. Words which end in CV# can have basic M-forms marked by metathesis (with presence or lack of various kinds of vowel assimilation) or by lack of consonant insertion, with some Meto varieties also showing variation between different word classes.

In the context of other linguistic alternations and markers of identity, such differences in the realisation of U-forms and M-forms are an additional strategy for marking linguistic identity. They are also perceived this way by both insiders and outsiders.

In her analysis of consonant insertion in Nai'bais Amfo'an, Culhane (2018) reports that this process is seen by speakers as a marker of identity. Thus, Culhane's main consultant told her when she began her work: "Here in Amfo'an we add consonants at the end of sentences. That's how you know someone is from Amfo'an." Similarly, this process is viewed by outsiders as distinctive. When I collected Amfo'an data I was accompanied by speakers of Amanuban from So'e. On the way up to Amfo'an, my friends reported that "all the words there end in <g>", referring to the process of consonant insertion used to form the U-forms of nouns which end in /o/ and /u/ (§3.3.7.2).

Similarly, Amarasi speakers from Koro'oto hamlet know that speakers from the hamlet of Fo'asa' have different M-forms before enclitics (e.g. as seen in Koro'oto *neɛŋgw=ee*, Fo'asa' *neɔŋg=ee* 'the sky, day'). Likewise, when collecting data on Fatule'u, Kopas, and Timaus while accompanied by Roni (my main Amarasi consultant), the different patterns of metathesis and consonant insertion in these Meto varieties were very salient to him.

Furthermore, differences in the realisation of U-forms and M-forms are quite difficult for speakers of different varieties of Meto to copy. In discussions with Roni after collecting Timaus data, he was generally unable to reproduce the kinds of consonant insertion seen there, despite the correspondences between Amarasi and Timaus being regular.

Similarly, I have overheard speakers of Amanuban attempt, but fail, to correctly copy patterns of metathesis in Amarasi. While Amanuban speakers know there are differences in vocabulary and metathesis between their speech and Amarasi, they are not necessarily able to combine the two together correctly. This is in contrast with other some other differences, such as the use of /r/ in Amarasi where Amanuban has /l/.

Examples (1) and (2) below show the same way of saying a number of phrases in Amanuban and Amarasi. In both varieties verbs before the inceptive enclitic =*een* undergo consonant insertion, metathesis, and vowel assimilation, but with different consonants inserted. Where Amarasi inserts /gw/, Amanuban inserts /w/ and where Amarasi inserts /dʒ/, Amanuban inserts a palatal glide /j/.

8 Contributions and conclusions

- |                                                                                                                                                                                                                                                                                                                                                                                                                                       |                                                                                                                                                                                                                                                                                                                                                                                                                                         |
|---------------------------------------------------------------------------------------------------------------------------------------------------------------------------------------------------------------------------------------------------------------------------------------------------------------------------------------------------------------------------------------------------------------------------------------|-----------------------------------------------------------------------------------------------------------------------------------------------------------------------------------------------------------------------------------------------------------------------------------------------------------------------------------------------------------------------------------------------------------------------------------------|
| <p>(1) Amanuban:</p> <p>a. <i>hai m-faanj=een.</i><br/>         hai m-fani=ena<br/>         1PX 1PX/2-back\M̄=INCEP<br/>         ‘We’ll head back now.’</p> <p>b. <i>hai m-naaw=een.</i><br/>         hai m-nao=ena<br/>         1PX 1PX/2-go\M̄=INCEP<br/>         ‘We’ll get going now.’</p> <p>c. <i>hai m-finj=een.</i><br/>         hai m-fini=ena<br/>         1PX 1PX/2-pass\M̄=INCEP<br/>         ‘We’ll keep going now.’</p> | <p>(2) Amarasi:</p> <p>a. <i>hai m-faanɟ=een.</i><br/>         hai m-fani=ena<br/>         1PX 1PX/2-back\M̄=INCEP<br/>         ‘We’ll head back now.’</p> <p>b. <i>hai m-naagw=een.</i><br/>         hai m-nao=ena<br/>         1PX 1PX/2-go\M̄=INCEP<br/>         ‘We’ll get going now.’</p> <p>c. <i>hai m-koongw=een.</i><br/>         hai m-kono=ena<br/>         1PX 1PX/2-pass\M̄=INCEP<br/>         ‘We’ll keep going now.’</p> |
|---------------------------------------------------------------------------------------------------------------------------------------------------------------------------------------------------------------------------------------------------------------------------------------------------------------------------------------------------------------------------------------------------------------------------------------|-----------------------------------------------------------------------------------------------------------------------------------------------------------------------------------------------------------------------------------------------------------------------------------------------------------------------------------------------------------------------------------------------------------------------------------------|

In addition to the differences in consonant insertion, there are also differences in vocabulary: Amarasi has  $\sqrt{kono}$  ‘pass’ and Amanuban has  $\sqrt{fini}$  ‘pass’. While Amanuban speakers are aware of such differences, they are not necessarily able to combine the two together. The top line of example (3) below was said by one of my Amanuban friends when trying to adapt their speech to Amarasi.

- (3) incorrect Amarasi: *hai m-koomɟ=een.* ← hai m-komi=een  
 correct Amarasi: *hai m-koongw=een.* ← hai m-kono=een  
 correct Amanuban: *hai m-finj=een.* ← hai m-fini=een  
 ‘We’ll keep going now.’ observation

In this example, the Amanuban speaker has had some success in selecting the correct verb, though has selected the wrong medial nasal with /m/ instead of /n/.<sup>3</sup> They have also correctly identified a rule along the lines of “Amarasi inserts /ɟ/ where we insert /j/”. Because of this they have inserted /ɟ/ for this sentence. However, the difference in the quality of the final vowels of Amarasi  $\sqrt{kono}$  ‘pass’ and Amanuban  $\sqrt{fini}$  ‘pass’ means that application of this rule yields an incorrect result in this instance.

<sup>3</sup>The selection of the incorrect nasal /m/ rather than correct /n/ probably came about partly in order to differentiate this form from  $\sqrt{koni}$  ‘copulate’.

## 8.2.2 Environments for U-forms and M-forms

The realisation of the U-form and M-form of words is one dimension across which speakers of Meto can mark identity. Another dimension is the environments in which metathesis occurs. For instance, in Kotos Amarasi metathesis is blocked before words which begin with a consonant cluster (§4.6), while in Ro'is Amarasi metathesis freely occurs before such words (§4.6.3). This yields pairs such as Kotos *umi kbubu?* and Ro'is *uim kbubu?* 'round house', or Kotos *kruru tnana-f* Ro'is *kruur tnana-f* 'middle finger'. More examples are given in Table 4.16 on page 207.

Similarly, consonant-final verbs do not undergo metathesis in Kotos Amarasi (§7.4.2), while in Ro'is Amarasi verbs with a final /n/ are eligible to undergo metathesis (§7.11.1). Two examples of Ro'is phrases with metathesis resulting in a final consonant cluster are given in (4) and (5) below along with their Kotos equivalents.

- |                                                                                                                  |                                                                                                                         |
|------------------------------------------------------------------------------------------------------------------|-------------------------------------------------------------------------------------------------------------------------|
| (4) Ro'is: <i>siin na-saap=n.</i><br>Kotos: <i>siin na-sapa=n.</i><br>3PL 3-kick=PL<br>'They're playing soccer.' | (5) Ro'is: <i>raump=ein n-maet=n.</i><br>Kotos: <i>paku=n n-mate=n.</i><br>light=PL 3-die=PL<br>'The lights have died.' |
|------------------------------------------------------------------------------------------------------------------|-------------------------------------------------------------------------------------------------------------------------|

Another dimension across which differences in metathesis can be marked is in the functions of U-forms and M-forms. In this book I have described and analysed the functions of U-forms and M-forms only in Kotos Amarasi (as spoken in Koro'oto hamlet). Although the full details remain to be investigated, data from other varieties of Meto shows that metathesis behaves differently in different varieties.

Thus, for instance, in Amfo'an (Culhane 2018) and Timaus (own fieldnotes) verbs take the U-form much more often than they do in Kotos Amarasi. This is clearly exemplified in (6)–(9) below with a selection of parallel passages from the gospel of Mark in Amarasi and Amfo'an (Unit Bahasa & Budaya 2018). The Amfo'an version is given below the Amarasi. Verbs which are metathesised in Amarasi but unmetathesised in Amfo'an are indicated.

- |                                                                                                                                                                                                            |           |
|------------------------------------------------------------------------------------------------------------------------------------------------------------------------------------------------------------|-----------|
| (6) <i>na-huun na-?ko nai? Yesus n-ait</i> <i>iin mepu,</i><br><i>na-hunu na-?ko nai Yesus n-aiti</i> <i>iin mepug,</i><br>3-first    3-ABL Mr. Jesus 3-pick.up 3SG work<br>'Before Jesus began his work,' | Mark 1:2a |
|------------------------------------------------------------------------------------------------------------------------------------------------------------------------------------------------------------|-----------|

## 8 Contributions and conclusions

- (7) *n-ok ranan mee henati? paah naan bisa n-haek na-baar?*  
*na-tuin lalan mee henati? paah naan na-be?i a|n-hake na-bala?*  
 3-with way what IRR country 2DEM 3-able 3-stand 3-constant  
 ‘In what way will that country be able to endure?’ Mark 3:24
- (8) *ma oras maans =ii n-maeb on nana =te*  
*ma tabug manas a|n-mabe on nane*  
 and time sun =1DET 3-afternoon like 2DEM =SUB  
 ‘And when the sun was about to go down,’ Mark 11:19
- (9) *onaim hii m-fain nai rab~raab!*  
*ees on naan hii a|m-fani nai lab~laab!*  
 and.so 2PL 1PX/2-return already INTNS~quick  
 ‘So return quickly!’ Mark 16:7

The Amfo'an gospel of Mark has been translated by native speakers from the Amarasi version. This means that the differences in metathesis seen in (6)–(9) above reflect deliberate decisions by Amfo'an speakers to unmetathesise certain verbs to yield a more natural translation.

While the exact function of metathesis in Amfo'an discourse remains to be fully worked out, it is clear that the analysis I proposed for Amarasi in Chapter 7 cannot be straightforwardly extended to cover the Amfo'an data.

Regarding metathesis in the syntax, my Timaus data shows that certain noun phrases occur with a metathesised head while others do not. In my Timaus data I have ten names of different kinds of birds composed of the noun *kolo* ‘bird’ (phrase-final *kolugw*) followed by a nominal modifier. Of these, the head is metathesised in six, unmetathesised in four, and one shows variation. These Timaus bird names are given in Table 8.3 on the next page. Whatever the basis for this variation in Timaus, it is clearly different from Amarasi, in which head nouns obligatorily occur metathesised when followed by an attributive modifier.

Similarly, in Insana data given by Schulte Nordholt (1971), certain noun phrases have an unmetathesised head while others have a metathesised head. Examples of phrases with a metathesised head include *lais meto?* ‘traditional matters’ (Amarasi *rais meto?*), and *neon tees* ‘sunset’ (Amarasi *neon tees*). Examples of phrases with an unmetathesised head include *mone fe?u* ‘son-in-law, lit. new male’ (Amarasi *moen fe?u*) and *tasi mone* ‘southern sea, lit. male sea’ (Amarasi *tais mone*). Again, this reflects a different use of metathesis in the syntax between Insana and Amarasi.

Metathesis is a marker of identity within the Atoni ethno-linguistic group. The presence of metathesis in this language cluster sets it apart from other lo-

### 8.3 Metathesis and unmetathesis as complementary pairs

Table 8.3: Bird names in Timaus

| Head        | Modifier       | gloss                     |
|-------------|----------------|---------------------------|
| <i>kolo</i> | <i>anal</i>    | ‘sparrow’                 |
| <i>kolo</i> | <i>fumakiḏ</i> | ‘orange-banded thrush’    |
| <i>kolo</i> | <i>kael</i>    | ‘yellow-crested cockatoo’ |
| <i>kolo</i> | <i>kefar</i>   | ‘pigeon’                  |
| <i>kolo</i> | <i>kuis</i>    | ‘thrush’                  |
| <i>kolo</i> | <i>luan</i>    | ‘wild pigeon’             |
| <i>kolo</i> | <i>kaa?</i>    | ‘crow’                    |
| <i>kool</i> | <i>kaa?</i>    | ‘crow’                    |
| <i>kool</i> | <i>kita?</i>   | ‘great-billed parrot’     |
| <i>kool</i> | <i>kukiḏ</i>   | ‘collared dove’           |
| <i>kool</i> | <i>otos</i>    | ‘barred dove’             |

cal groups, such as Tetun and the Rote languages – though not from Helong (§2.3.9) – and the differences between the forms, functions, and environments of metathesis between different varieties of Meto vary and serve to mark sub-identities among the Atoni.

### 8.3 Metathesis and unmetathesis as complementary pairs

In addition to marking differences in identity, metathesis – the pairing of two forms which together make a fully grammatical functional whole – also reflects the fundamental Atoni conceptualisation of societal and cosmic organisation. The complementarity of metathesis and unmetathesis in the syntax, and the parallelism of unmetathesis with metathesis in the discourse reflects the Atoni division of the world into complementary pairs.

The relationship between M-forms and U-forms in the syntax (Chapter 6) is represented in Figure 8.3a, in which each is one half of a whole with the latter completing the former. Similarly, the relationship between U-forms and M-forms in the discourse (Chapter 7) is visualised in Figure 8.3b, with the latter resolving the former.

An example of each of these complementary pairs is given below with (10) showing a syntactically conditioned M-form||U-form pair and example (11) showing a discourse-driven U-form||M-form pair.

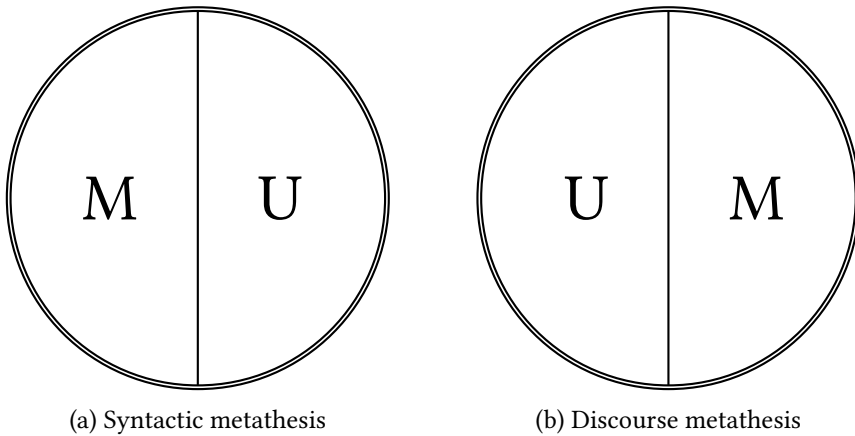

Figure 8.3: Complementary metatheses

- (10) *na-tuu?*      *tain*    *tuni,*      *tua, =ma*  
 na-tuʔu      tani      tuni      tua =ma  
 3-make.knot rope\M    gawang.palm\U    ADDR =and  
 ‘(He) ties up a rope made from gawang palm (leaves)’ 120923-2, 1.39 🔊
- (11) *m-ak    hai nua =kai*      *m-taikobi*    =m    hai    *m-maet*    oke?  
 m-ak    hai nua =kai    m-taikobi    =ma    hai    m-mate    oke?  
 1PX/2-say 1PX two 1PX.ACC 1PX/2-fall\U =and 1PX 1PX/2-die\M all  
 ‘So we two will fall down and (then) both die.’ 130909-6, 0.39 🔊

The parallelism and complementarity of U-forms with M-forms and M-forms with U-forms reflects fundamental Atoni philosophical and conceptual notions of the structure of the world as being composed of binary and complementary pairs. One explicit use of these pairs in linguistic structure is in Amarasi poetry.

### 8.3.1 Metathetic poetic parallelism

The role of parallelism in Timor has already been touched on in §7.8, in which I discussed the structure of poetry. Poetry in Amarasi makes use of canonical parallelism (Fox 1988; 2014), the pairing of pre-determined and semantically related words. Amarasi poetry is an explicit use of the complementarity which exists between metathesis and unmetathesis.

Example (12) below, drawn from a performed chant (*aʔa sramat*), shows the way in which semantic parallelism operates in Amarasi. Nearly every content

8.3 Metathesis and unmetathesis as complementary pairs

word co-occurs in the same line in a structurally parallel way with a semantically similar content word, giving three sets of doublets in a single line. Doublets are joined by linking lines.

- (12) Amarasi chant (*aʔa sramat*): 140726 🔊
- a. 

|                  |     |               |       |              |     |               |          |
|------------------|-----|---------------|-------|--------------|-----|---------------|----------|
| <i>bainesu-t</i> | =ma | <i>ronaen</i> | n-eu  | <i>mutiʔ</i> | =ma | <i>mnatuʔ</i> | et       |
| look.up          |     | =and greeting | 3-DAT | silver       |     | =and gold     | IPFV.LOC |
- |              |                |     |               |       |
|--------------|----------------|-----|---------------|-------|
| <i>muʔit</i> | ma-hine-ʔ      | =ma | <i>mnatuʔ</i> | nee   |
| silver       | PROP-know-PROP |     | =and gold     | PAUSE |
- ‘Greetings and honour to all people, who are like silver and gold, wise and knowledgeable silver and gold,’ 0.00
- b. *MA-HINE-ʔ*  
PROP-know-PROP  
‘So wise.’ 0.05

When the doublet consists of a pair of verbs, it is possible, though not obligatory, for the first verb to occur in the U-form and the second in the M-form. Two examples are given in (13) and (14) below. In both examples the indicated doublets are both semantically and morphologically parallel. Thus, for instance, in example (13) the semantic doublet, *m-tenu* // *mu-haof* ‘umbrella // shade’ is also a morphological doublet composed of U-form // M-form.

- (13) 

|                |                  |      |                |         |              |         |
|----------------|------------------|------|----------------|---------|--------------|---------|
| <i>henatiʔ</i> | <i>m-tenu</i>    | =m   | <i>mu-haof</i> | too     | <i>tafaʔ</i> | =kai    |
| henatiʔ        | m-tenu           | =ma  | mu-hafo        | too     | tafaʔ        | =kai    |
| IRR            | 1PX/2-umbrella\U | =and | 2SG-shade\M    | citizen | small        | 1PX.ACC |
- ‘So that you might shade [doublet] us small people.’ 130825-3, 1.21 🔊
- (14) 

|                    |              |              |                      |            |
|--------------------|--------------|--------------|----------------------|------------|
| <i>hai m-nonaʔ</i> | =ma          | <i>m-fee</i> | <i>fuaʔturuʔ reʔ</i> | <i>hai</i> |
| hai m-nonaʔ        | =ma          | m-fee        | fuaʔturuʔ reʔ        | hai        |
| 1PX                | 1PX/2-hand\U | =and         | 1PX/2-give offering  | REL 1PX    |
- |               |      |               |                  |                    |
|---------------|------|---------------|------------------|--------------------|
| <i>n-simo</i> | =ma  | <i>n-toup</i> | =siin mi-ʔko     | <i>hoo ʔnima-m</i> |
| n-simo        | =ma  | n-topu        | =sini mi-ʔko     | hoo ʔnima-m        |
| 3-receive\U   | =and | 3-receive\M   | =3PL 1PX/2PL-ABL | 2SG hand-1PX/2GEN  |
- a-ma-neka-b,*  
a-ma-neka-b,  
NML-PROP-love-TR
- ‘We give offerings we received from your loving hand.’ observation

## 8 Contributions and conclusions

Another kind of metathetic parallelism occurs in chants of the *aʔa sramat* genre. In such chants a leader of a group will chant one line, after which the rest of the group repeats a word from that line. It is common, though not obligatory, for the repeated word to occur in the opposite U-form/M-form compared with the form the leader used. If the leader uses a U-form, the group typically uses an M-form, and vice versa.<sup>4</sup>

One example is given in (15) below, in which a verbal U-form said by the leader is repeated in the M-form by the rest of the group. Such examples are formally identical to the use of metathesis in question-answer pairs (§7.10.4.2). In each instance one speaker uses a verbal U-form which is completed by the next speaker(s) using an M-form of the same verb.

- (15) a. *ka= t-tok~took =ma tak~t-ak =fa =te, hiit ta-ʔeuk*  
*ka= t-tok~toko =ma tak~t-ak =fa =te hiti ta-ʔeku*  
 NEG= 1PI-INTNS~sit\M =and INTNS~1PI-say =NEG =SUB 1PI 1PI-meet\M  
 =ma ta-tefa =m neee  
 =ma ta-tefa =ma neee  
 =and 1PI-meet\U =and PAUSE  
 ‘We don’t just sit and talk, we interact and meet.’ 120715-0, 0.30 
- b. TA-TEEF  
 ta-tefa  
 1PI-meet\M  
 ‘We meet.’ 0.35

It is also possible for the repeated word to be a noun. When this occurs, the first instance of the noun often occurs with a vowel-initial enclitic attached which triggers the M-form (Chapter 5). The whole group will then repeat the noun without the enclitic; thus in the U-form. Two examples are given in (16) and (17) below, each of which comes from a single prayer.

In example (16a) the noun phrase *Smana Kninu?* ‘Holy Spirit’ is modified by the determiner =*aa*, and thus occurs in the M-form. The final word of this noun phrase is then chanted by the whole group, though in the U-form.

- (16) Prayer composed in poetic language: 140726, 0.21 
- a. *iin kuu-n ees re? a|n-sia =ma n-naib =kii n-eik ina*  
*ini kuu-n esa re? n-sia =ma n-nabi =kii n-eki ina*  
 3SG self-3SG.GEN COP REL 3-lead =ma 3-guide\M =2PL.ACC 3-use\M 3SG

<sup>4</sup>Thanks go to Charles Grimes for bringing this to my attention.



### 8.3 Metathesis and unmetathesis as complementary pairs

*Smana* *Kninuʔ=aa* =*m nee*  
*smana-f kninuʔ=aa* =*ma nee*  
 spirit\M holy\M=0DET =and PAUSE  
 ‘It is he who leads and guides us with his Holy Spirit’

- b. *RO* *KNINUʔ*  
 very holy\U  
 ‘He is very holy.’

Similarly, in example (17a) the noun *arekot* ‘good’ is followed by a vowel-initial enclitic and occurs in the M-form. This word is then repeated by the whole group in (17b) in the U-form.

(17) Prayer composed in poetic language: 140726, 0.27 

- a. *etun hii ar=kii m-muiʔ reon =ma runat*  
*etun hii ar=kii m-muʔi reon =ma runat*  
 so.that 2PL all=2PL.ACC 1PX/2-have\M event =and plan  
*a-reok-t=aa* =*m nee*  
*a-reko-t=aa* =*ma nee*  
 NML-good\M-NML=0DET =and PAUSE

‘So that you will have success in your event and plan.’

- b. *A-REKO-T*  
 NML-good\U-NML  
 ‘It is very good.’

The pattern in examples (16) and (17) with paired nominals is U-form||M-form, while with verbs the pattern is M-form||U-form, as seen in (15). The reason noun doublets occur in the order M-form||U-form, and verb doublets occur in the order U-form||M-form is straightforwardly explained by their order in non-poetic speech. In the syntax, an M-form noun signals an incomplete attributive phrase which requires completion from a following form, typically a U-form (Chapter 6). In the discourse, a U-form occurs first, and requires resolution from a subsequent clause, which typically contains an M-form (Chapter 7).

The use of alternate M-forms and U-forms in Amarasi poetry – a style of speech in which parallel forms are obligatory – is an explicit utilisation of the complementarity which exists between metathesis and unmetathesis.

### 8.3.2 Cultural and conceptual complementarity

As discussed in §8.1, metathesis is a key element of the Amarasi language around which many other linguistic structures are organised. However, more than simply being a key linguistic structure, the complementarity found between metathesis and unmetathesis is paralleled by the Atoni conceptualisation of the world as being composed of complementary parts.

At the beginning of his discussion of the “Political system as approached in Timorese [Atoni] thinking”, Schulte Nordholt (1971: 408) gives a set of complementary concepts, some of which are given in Table 8.4. Of these concepts he states: “All these pairs of opposites fit into one scheme and combine to form one important dichotomy. [...] The one is inconceivable without the other.”

Table 8.4: Atoni complementary concepts (Schulte Nordholt 1971: 408)

|                 |   |               |
|-----------------|---|---------------|
| female          | – | male          |
| wife            | – | husband       |
| sister          | – | brother       |
| female ancestor | – | male ancestor |
| inside          | – | outside       |
| west/north      | – | east/south    |
| yellow          | – | red           |

The Atoni conceptualisation of social and cosmic order is classified and arranged around such complementary pairs. A visual analogy of this complementarity can be seen on any piece of Atoni cloth, illustrated in Figure 8.4 below with an Amarasi scarf. Each half of this cloth, along both horizontal and vertical axes, is opposite to and a mirror image of the other half; each half is the complement of the other, and neither is complete without the other.

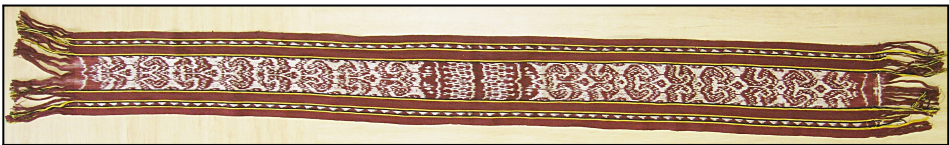

Figure 8.4: Amarasi scarf

Dualism and complementarity in the Atoni world goes beyond the simple “two-column analysis” represented in Table 8.4. There are complex relationships

### 8.3 Metathesis and unmetathesis as complementary pairs

between these categories which include asymmetry, analogical cross-over and recursive parallelism (Fox 1989).

Of all complementary pairs, one significant relationship is that of *feto-mone* 'female-male'. A category classified as *feto* 'female' will have a complementary category classified as *mone* 'male'. The classification of pairs as *feto-mone* 'female-male' is not necessarily linked to the actual biological gender of the members of the pairs, but is rather a way of expressing and describing the complementarity which exists between the two categories.

One instance in which the *feto-mone* relationship holds is in two families related by marriage. When two families are related by marriage, those who have given their daughter in marriage (the wife-givers) are classified as *mone* 'male' in relation to those who have received the woman. Those who have received the woman are classified as *feto* 'female' in relation to the wife givers.

In addition to being complementary, with each completing the other, the relationship between the wife-givers and the wife-receivers is also asymmetrical. Schulte Nordholt (1971) analysed this asymmetry in terms of "superordination" and "subordination":

[...] the [female] *ume* [house] receiving a woman (who is the source of life) is inferior in respect of the [male] *one* which is the giver of life and hence its superior. This relationship of subordination and superordination is expressed in terms of *feto-mone*. But at the same time the term *feto-mone* indicates that the one cannot exist without the other, as life is impossible without the unity of male and female. Thus *feto-mone* groups form each other's complements. (Schulte Nordholt 1971: 411)

While Schulte Nordholt accurately identifies the asymmetrical nature of this relationship the language of "superordination" and "subordination" may not be the best description of the asymmetry. Instead, as the givers of the gift, the wife-givers are in a relationship of precedence to the *feto* 'female' wife-receivers (Fox 1994; 1999). Because the wife-receivers are *feto* 'female' and the wife-givers are *mone* 'male', in this particular context *mone* 'male' precedes *feto* 'female'. This is an example of categorical asymmetry (Fox 1994: 47).

The relationship between *feto* 'female' and *mone* 'male' groups is not fixed. As discussed by Fox (1999), these relationships are fluid and can be reversed. Groups constantly seek to re-negotiate their relationship, with wife-receivers seeking to return a woman to their wife-givers, and thus reversing their relationship.

A similar conclusion is also reached by McWilliam (2002) in his study of place and precedence in Amanuban. While the domain of Amanuban was politically

## 8 Contributions and conclusions

organised with dual classification, “these structures tended to be flexible, strategic, and opportunistic” McWilliam (2002: 287). Complementary categories are tools, not restrictions, for Atoni thought and classification.

Another area in which the *feto-mone* ‘female-male’ complementary pair occurs is in the traditional political structure of Atoni society. In Insana, for instance, the supreme ruler at the centre of a realm was classified as *feto* ‘female’. This *feto* ruler was the guardian of the sacred objects and responsible for the proper maintenance of ritual. He was complemented by another ruler, classified as *mone* ‘male’. This *mone* ruler was the executive authority of the realm and had responsibility for warfare (Schulte Nordholt 1971: 371ff).<sup>5</sup>

In this context, it would be erroneous to identify the *mone* ‘male’ ruler as preceding the *feto* ‘female’ ruler. Instead, it is the supreme *feto* ‘female’ ruler at the centre of the domain, around whom all the other parts revolve and who holds all these parts together, who precedes the *mone* ‘male’ ruler.

What is most important in this relationship is the complementarity between the *feto* ‘female’ ruler and the *mone* ‘male’ ruler, with both co-existing in balancing roles. The complementarity between *feto-mone* ‘female-male’, in which each is one half of a whole, is represented in Figure 8.5a below.

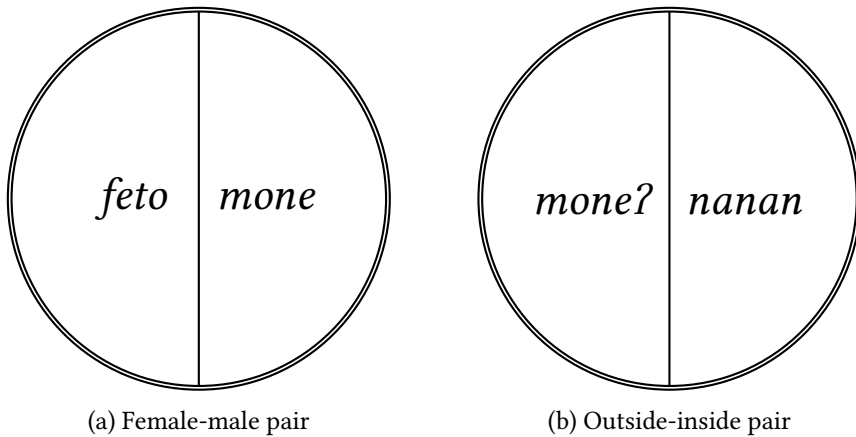

Figure 8.5: Complementary pairs

Another pair of complementary concepts in Atoni culture is *mone?-nanan* ‘outside-inside’, or ‘periphery-centre’. The *nanan* ‘inside, centre’ is symbolic of unity between different parts. It is the location of the supreme ruler in a realm,

---

<sup>5</sup>Both rulers were biologically male.

### 8.3 Metathesis and unmetathesis as complementary pairs

and the area of a house to which agnates (blood relatives) have full access (Cunningham 1964).

Just as the *feto-mone* ‘female-male’ pair is asymmetrical, the *mone?-nanan* ‘outside-inside’ pair is also asymmetrical, with *nanan* ‘inside’ in precedence to *mone?* ‘outside’ (Cunningham 1964; Schulte Nordholt 1971; Fox 1989). The relationship between the pair *mone?-nanan* is represented in Figure 8.5b.

The phonological similarity of the terms *mone* ‘male’ and *mone?* ‘outside’ has given rise to a link in Atoni thought between these two terms and has led to what Fox (1989) terms analogical cross-over: “Male [*mone*], which is superior in certain contexts is associated with the outside [*mone?*], which is inferior” Fox (1989: 49). The association between *mone* ‘male’ and *mone?* ‘outside’, has also led to an association between the complements of each of these terms, with *feto* ‘female’ being associated with *nanan* ‘inside’.<sup>6</sup>

This association has led to analogical crossover (Fox 1989). The member of each pair with precedence is linked to the member of the other pair which does not have precedence. This analogical cross-over is represented in Figure 8.6 below in which each member of each asymmetrical pair is connected with the opposite member of the other asymmetrical pair.

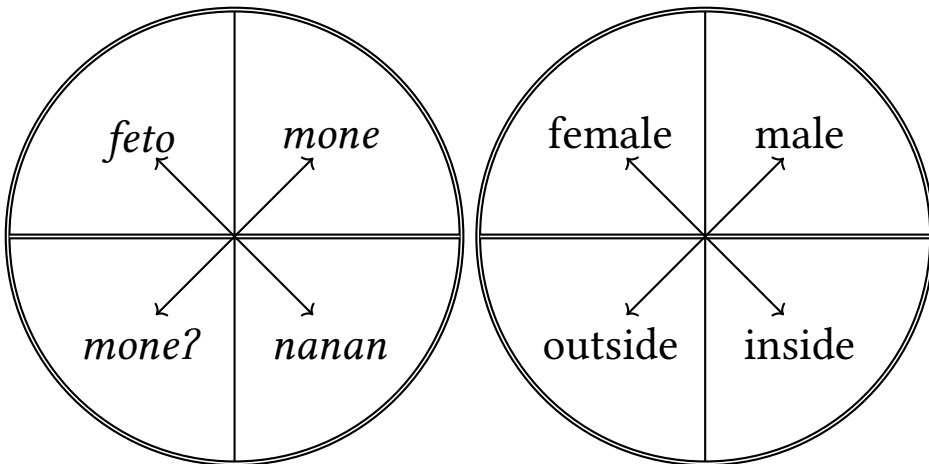

Figure 8.6: Analogical cross-over

<sup>6</sup>The term *mone* ‘male’ is a reflex of Proto-Malayo-Polynesian \*maRuqanay ‘male’. The term *mone?* ‘outside’ is probably inherited from Proto-Malayo-Polynesian \*ma-udehi ‘behind’, also reflected by Amarasi *na-muni* ‘be at the end’ and *munif* ‘young’. Whatever the ultimate etymology of the terms *mone* ‘male’ and *mone?* ‘outside’, it is the folk etymology ascribed to them by speakers which has created (or reinforced) the link between the two (Fox 1989: 49).

## 8 Contributions and conclusions

One instance of this association has been seen in the fact that the *feto* ‘female ruler is located in the *nanan* ‘centre’ of the realm. Another example of this association is seen in the categorisation of the *tasi* ‘sea, ocean’, which is classified as consisting of two parts. The *nanan* ‘inner’ circle of sea near the coast and bays is the *tais feto* ‘female sea’, and the distant *mone?* ‘outer’ part is known as the *tais mone* ‘male sea’ (Cunningham 1964: 50). This means that the northern Savu Sea is the *tais feto* ‘female sea’, and the southern Timor Sea is the *tais mone* ‘male sea’, as illustrated in Figure 8.7

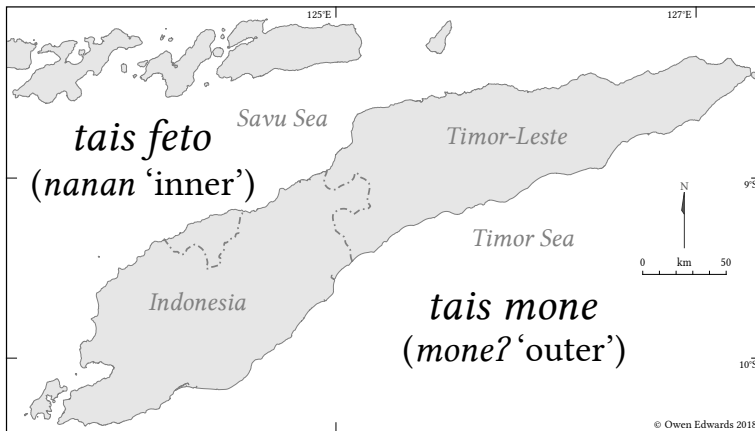

Figure 8.7: Timor and its seas

### 8.3.3 Metathetic parallel complementarity

It is within this rich world of symbolic dualistic and complementary classification that I place my analysis of metathesis in Amarasi. Unmetathesised forms and metathesised forms are one another’s complements. This is demonstrably a fact of linguistic structure. In the syntax, an M-form cannot occur in isolation and must be completed by a U-form. In the discourse a U-form does not occur alone and must be completed by another form, typically an M-form.

The identification of U-forms and M-forms as complementary pairs is not equivalent to noting that these forms are formal opposites. Instead, this identification is based on their usage, the fact that each form must occur with the other in certain contexts. Furthermore, in Amarasi poetry – a genre in which parallelism is obligatory – unmetathesised and metathesised forms are explicitly used as complementary pairs, as discussed in §8.3.1 above.

### 8.3 Metathesis and unmetathesis as complementary pairs

Syntactic M-forms ( $M_S$ ) are complemented by syntactic U-forms ( $U_S$ ), and discourse U-forms ( $U_D$ ) are complemented by discourse M-forms ( $M_D$ ). In addition, the syntactic  $M_S\|U_S$  relationship is itself paralleled and complemented by the opposite discourse  $U_D\|M_D$  relationship. That M-forms require completion in the syntax is paralleled by the fact that in the discourse U-forms which require completion. The parallel relationship between the syntactic  $M_S\|U_S$  pair and discourse  $U_D\|M_D$  pairs is represented in Figure 8.8 below. With an example of each given in (18) and (19).

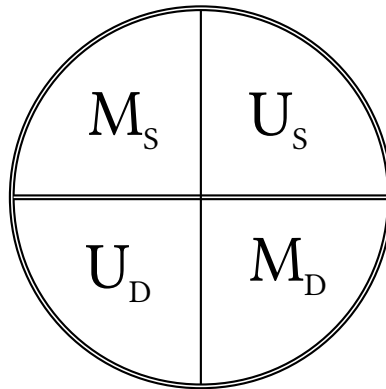

Figure 8.8: Metathesis and unmetathesis in Amarasi

(18) Syntactic metathetic complementarity  $M_S\|U_S$ :

|                |                                                                                       |                                                                                        |                 |  |
|----------------|---------------------------------------------------------------------------------------|----------------------------------------------------------------------------------------|-----------------|--|
| <i>na-tuu?</i> | <div style="border: 1px solid black; padding: 2px; display: inline-block;">tain</div> | <div style="border: 1px solid black; padding: 2px; display: inline-block;">tuni,</div> | <i>tua, =ma</i> |  |
| na-tu?u        | tani                                                                                  | tuni                                                                                   | tua =ma         |  |
| 3-make.knot    | rope\M <sub>S</sub>                                                                   | gewang.palm\U <sub>S</sub>                                                             | ADDR =and       |  |

‘(He) ties up a rope made from gewang palm (leaves)’ 120923-2, 1.39 ▶▶

(19) Discourse metathetic complementarity  $U_D\|M_D$ :

|             |                     |                                                                                            |                           |            |                                                                                         |                          |     |
|-------------|---------------------|--------------------------------------------------------------------------------------------|---------------------------|------------|-----------------------------------------------------------------------------------------|--------------------------|-----|
| <i>m-ak</i> | <i>hai nua =kai</i> | <div style="border: 1px solid black; padding: 2px; display: inline-block;">m-taikobi</div> | <i>=m</i>                 | <i>hai</i> | <div style="border: 1px solid black; padding: 2px; display: inline-block;">m-maet</div> | <i>oke?</i>              |     |
| m-ak        | hai nua =kai        | m-taikobi                                                                                  | =ma                       | hai        | m-mate                                                                                  | oke?                     |     |
| 1PX/2-say   | 1PX two             | 1PX.ACC                                                                                    | 1PX/2-fall\U <sub>D</sub> | =and       | 1PX                                                                                     | 1PX/2-die\M <sub>D</sub> | all |

‘So we two will fall down and (then) both die.’ 130909-6, 0.39 ▶▶

This is an example of analogical cross-over similar to the association between *feto-mone* ‘female-male’ and *mone?-nanan* ‘outside-inside’ discussed above. In the case of metathesis, the association is not between two formally similar (and

perhaps related) forms but instead it is between two formally identical forms, with the same derivation which occur at different levels of the grammar.

The relationship between the four metathesis forms in Figure 8.8 is an instance of what I term *cyclical complementarity*. A syntactic M-form is complemented by a syntactic U-form, which is paralleled by a discourse M-form which is the complement of a discourse U-form, which is paralleled by a syntactic M-form, and so on *ad infinitum*. Such cyclical complementarity is also found in systems of marriage exchange in this region (whether formalised or informal), whereby the wife-receivers will eventually return a woman to their wife-givers, and thereby become the wife-givers, and so on. Among the Atoni, for instance:

[...] it is to the advantage of wife-givers to maintain their asymmetric relation with their wife-takers and to the advantage of wife-takers to reverse this relationship by returning a woman to their wife-givers [...] (Fox 1999)

The complementarity between metathesis and unmetathesis in Amarasi and its strong congruence with the conceptual framework, cosmic classification, and social organisation of Amarasi speakers raises a number of interesting questions, which I only pose up at this point.

Firstly, to what extent does the complementarity between unmetathesis and metathesis occur in other Meto varieties? Speakers of other Meto varieties have the same conceptual frameworks as speakers of Amarasi. Thus, we expect this relationship to hold, even if U-forms and M-forms have different forms and functions. To answer this question will require a detailed study of metatheses across other varieties of Meto.

Secondly, is the prevalence of synchronic metathesis in the greater Timor region (see Figure 2.1 on page 27) linked in any way to the widespread use of complementary and dualistic classification in this region? Answering this question will require a study of whether other regions in which complementarity is common also have linguistic structures which are complementary in a way that parallels that of metathesis in Amarasi.

Finally, how did the complementary nature of metathesis and unmetathesis arise in Amarasi? Is it simply an accidental by-product of the environments in which a phonological process became morphological? Or is it a result of speakers (consciously or unconsciously) noticing things about culture and mirroring them in grammar, and vice versa?

One fruitful avenue of work which may help answer this last question is a thorough structural examination of poetry and verbal art in Meto. In poetry the complementarity of U-forms and M-forms is explicitly utilised by speakers in more



8.3 Metathesis and unmetathesis as complementary pairs

fluid way than is seen in the syntax or discourse. It may be the case that poetry was the domain of language in which the complementarity between U-forms and M-forms first began.

For now, however, the last word and final statement on the source and origin, as well as the reasons and grounds of the parallelism and complementarity of metathesis and unmetathesis in Amarasi should be given to the Amarasi speakers themselves, expressed in their own poetic language composed in parallel pairs:

(20) Chant (*a?a sramat*) performed at a wedding service: 090524, 0.36 🔊

- a. *ar=kiit*    ta-hiin    =ma    ta-keo    *moni-t*    *mansion*  
*ar=kiti*    *ta-hini*    =ma    *ta-keo*    *moni-t*    *mansion*  
 all=1PI.ACC    1PI-know\M    =ma    1PI-aware live\U-NML    human
- pasan~pasan,*    bifee    atoni?    feto-f    nao-f  
*pasan~pasan*    *bifee*    *atoni?*    *feto-f*    *nao-f*  
 FRD~pair    woman    man    sister-GEN    brother-GEN
- ta-bua    ta-?-mees-?=oo-k    *n-bi*  
*ta-bua*    *ta-?-mese-?=oo-k*    *n-bi*  
 1PI-gather    1PI-TR-one\M-TR=REFL-3PI/1GEN    3-RL.LOC
- bare    *a-reko-t*    paha    =t    *nee,*  
 place    NML-good-NML    country    =SUB    PAUSE

‘We all know and are aware that the life of humans comes in pairs; woman and man, sister and brother, gathered together in unity, in places and countries that are good.’

b. *RO REKO*

‘It is very good.’



# Appendix A: Affixal morphology sketch

In this appendix I provide an overview of all Amarasi morphology not covered in the main body of this work. This includes all affixal morphology: prefixes (§A.1), circumfixes (§A.2) and suffixes (§A.3).

## A.1 Prefixes

### A.1.1 Verbal agreement prefixes

Amarasi has two sets of verbal agreement prefixes: vocalic prefixes, given in Table A.1a, and consonantal prefixes, given in Table A.1b. The consonantal prefixes consist of the initial consonant of the vocalic prefixes, bearing in mind that the 1SG vocalic prefix *u-* begins with a predictable glottal stop (§3.3.6). In Ro'is Amarasi the 1SG vocalic prefix is *ku-* and the 1SG consonantal prefix is *k-* before vowels and *ʔ-* before consonants.

Table A.1: Subject agreement prefixes

| (a) Vocalic |            |            | (b) Consonantal |           |           |
|-------------|------------|------------|-----------------|-----------|-----------|
|             | SG         | PL         |                 | SG        | PL        |
| 1           | <i>u-</i>  | <i>mi-</i> | 1               | <i>ʔ-</i> | <i>m-</i> |
| 1,2         |            | <i>ta-</i> | 1,2             |           | <i>t-</i> |
| 2           | <i>mu-</i> | <i>mi-</i> | 2               | <i>m-</i> | <i>m-</i> |
| 3           | <i>na-</i> | <i>na-</i> | 3               | <i>n-</i> | <i>n-</i> |

Which prefix set a verb takes is partially determined by the phonotactic shape of the verbal root, partially determined by the semantics of the verb and partially lexically determined. Which prefix set is taken by a verb root according to the structure of its root is summarised in Table A.2 below.

This table shows that consonantal prefixes are taken by roots which have three or more syllables, vowel-initial roots and all disyllabic loans. Roots which begin with a consonant cluster take the vocalic set. Disyllabic roots which begin

Table A.2: Verbal agreement prefix sets according to root shape

| Shape  |                              | Prefix Set       | Example           | Gloss        |
|--------|------------------------------|------------------|-------------------|--------------|
| (σ)σσσ | three or more syllables      | consonantal      | <i>n-ʔeusfani</i> | ‘sneeze’     |
| #CC    | cluster-initial disyllable   | vocalic          | <i>na-mnaha</i>   | ‘hungry’     |
| #V     | vowel-initial disyllable     | consonantal      | <i>n-inu</i>      | ‘drink’      |
| #C     | consonant-initial disyllable | {consonantal 75% | <i>na-sai</i>     | ‘flow’       |
|        |                              | {vocalic 25%     | <i>n-sae</i>      | ‘go up’      |
| #C     | {transitive<br>intransitive  | vocalic          | <i>na-tama</i>    | ‘make enter’ |
|        |                              | consonantal      | <i>n-tama</i>     | ‘enter’      |
| #C     | loan disyllable              | consonantal      | <i>n-dukun</i>    | ‘support’    |

with a consonant take either set, with the choice mostly being lexically specified, though some take either set with a difference in transitivity. In my current database I have 140 disyllabic consonant-initial verb roots which take the vocalic prefix set and 417 which take the consonantal set.

There are also a number of verb roots which can take both sets of prefixes with a difference in valency. Such roots take the consonantal prefixes when intransitive and vocalic prefixes when transitive. Two such roots are  $\sqrt{tama}$  ‘enter’ and  $\sqrt{ʔeka}$  ‘close’ each of which is intransitive with a consonantal prefix and transitive with a vocalic prefix. Thus, *iin n-taam* ‘s/he enters’ alongside *iin na-taam=ee* ‘s/he makes him/her enter’, and *iin n-ʔeek* ‘it is closed’ alongside *iin na-ʔeek=ee* ‘s/he closes it’. In most cases the transitive derivation of such roots also takes a transitive suffix *-ʔ* or *-b* (§A.3.2). Examples include  $\sqrt{fani}$  ‘return’ → *iin n-fain* ‘s/he goes back’ → *iin na-fain-ʔ=ee* ‘s/he returns it’ and  $\sqrt{nao}$  → *iin n-nao* ‘s/he goes’ → *iin na-nao-b=ee* ‘s/he makes him/her go’. See §A.3 below for more discussion of these transitive suffixes.

Any combination of a consonantal prefix followed by another consonant is an allowable stem-initial consonant cluster, even if it would violate the restrictions against root-initial consonant clusters given in §3.4.2.1. The only exception is a combination of *ʔ-* before a root which begins with */ʔ/*. Such instances always surface phonetically as a single glottal stop [ʔ] rather than geminate [ʔ:].

There are two verbs in Amarasi which have irregular inflections. Firstly, there is the verb for ‘come’, which has partially suppletive forms. The conjugation of ‘come’ is given in Table A.3a. Secondly, there is the verb for ‘eat (soft food)’, which is the only monosyllabic verb root in my database which takes agreement prefixes. This root takes vocalic prefixes, meaning that the resulting inflected

word comprises a disyllabic foot (§3.3.2). For the purposes of metathesis, the final CV sequence of the derived word (which is equivalent to the root) undergoes metathesis. Thus *na-ha* ‘3-eat\U’ → *na-ah* ‘3-eat\M’. The paradigm for  $\sqrt{ha}$  ‘eat (soft food)’ is given in Table A.3b.

Table A.3: Irregular verbal conjugations

| (a) $\sqrt{Vma}$ ‘come’ |             |               | (b) $\sqrt{ha}$ ‘eat (soft food)’ |              |                |
|-------------------------|-------------|---------------|-----------------------------------|--------------|----------------|
|                         | SG          | PL            |                                   | SG           | PL             |
| 1                       | <i>uum</i>  | <i>iim</i>    | 1                                 | <i>u-ah</i>  | <i>mi-ah</i>   |
| 1,2                     |             | <i>teem</i>   | 1,2                               |              | <i>ta-ah</i>   |
| 2                       | <i>uum</i>  | <i>iim</i>    | 2                                 | <i>mu-ah</i> | <i>mi-ah</i>   |
| 3                       | <i>neem</i> | <i>nema=n</i> | 3                                 | <i>na-ah</i> | <i>na-ha=n</i> |

### A.1.2 Reciprocal prefix

The reciprocal prefix is *ma-*. The addition of the reciprocal prefix to a verb makes it longer than a single foot, thus all verbs with this prefix take the consonantal agreement prefixes. Examples of verbs with *ma-* extracted from my corpus are given in (1) below, in which forms usually also occur with the plural enclitic *=ein/=n* (§5.6).

(1) Reciprocal *ma-*

|               |                |              |   |                    |                                |
|---------------|----------------|--------------|---|--------------------|--------------------------------|
| ‘hit’         | $\sqrt{bana}$  | + <i>ma-</i> | → | <i>n-ma-bana=n</i> | ‘hit one another’              |
| ‘hold’        | $\sqrt{na?a}$  | + <i>ma-</i> | → | <i>n-ma-na?a=n</i> | ‘hold on to one another’       |
| ‘shake hands’ | $\sqrt{tabe}$  | + <i>ma-</i> | → | <i>n-ma-tabe=n</i> | ‘shake hands with one another’ |
| ‘think’       | $\sqrt{tenab}$ | + <i>ma-</i> | → | <i>n-ma-tenab</i>  | ‘think one by one’             |
| ‘quarrel’     | $\sqrt{toe}$   | + <i>ma-</i> | → | <i>n-ma-toe=n</i>  | ‘quarrel with each o.’         |

This prefix has the allomorph *mak-* before some, but not all, roots which begin with /t/. I have so far collected six roots with initial /t/ which take the allomorph *mak-*. These six roots are given in (2) below. These forms can be compared with the final three forms in (1) which are all also roots with an initial /t/.

(2) Reciprocal *mak-*

|          |               |               |   |                       |                        |
|----------|---------------|---------------|---|-----------------------|------------------------|
| ‘ask’    | √ <i>tana</i> | + <i>mak-</i> | → | <i>n-mak-tana=n</i>   | ‘ask one another’      |
| ‘meet’   | √ <i>tefa</i> | + <i>mak-</i> | → | <i>n-mak-tefa=n</i>   | ‘meet one another’     |
| ‘angry’  | √ <i>toʔo</i> | + <i>mak-</i> | → | <i>n-mak-toʔo=n</i>   | ‘angry at one another’ |
| ‘tell’   | √ <i>tono</i> | + <i>mak-</i> | → | <i>n-mak-tono=n</i>   | ‘tell one another’     |
| ‘follow’ | √ <i>tuin</i> | + <i>mak-</i> | → | <i>n-mak-tuin=ein</i> | ‘consecutively’        |

## A.2 Circumfixes

### A.2.1 Nominalising *a...-t*

The nominalising circumfix *a...-t* (Ro'is Amarasi has *ka...-t*) has the allomorph *a...-s* on stems which contain a /t/. This circumfix typically derives nouns referring to people who carry out or who are characterised by the event/state encoded by the root.<sup>1</sup> When the root to which it attaches ends in a consonant, the suffixal part of this circumfix does not surface. Examples are given in (3) below.

(3) Nominalising circumfix *a...-t*

|                    |                |                 |   |                 |                                             |
|--------------------|----------------|-----------------|---|-----------------|---------------------------------------------|
| ‘work’             | √ <i>mepu</i>  | + <i>a...-t</i> | → | <i>a-mepu-t</i> | ‘worker’                                    |
| ‘read’             | √ <i>resa</i>  | + <i>a...-t</i> | → | <i>a-resa-t</i> | ‘reader’                                    |
| ‘stand’            | √ <i>hake</i>  | + <i>a...-t</i> | → | <i>a-hake-t</i> | ‘one who stands’                            |
| ‘invite’           | √ <i>skau</i>  | + <i>a...-t</i> | → | <i>a-skau-t</i> | ‘inviter’                                   |
| ‘pray’             | √ <i>ʔonen</i> | + <i>a...-t</i> | → | <i>a-ʔonen</i>  | ‘one who prays’                             |
| ‘agape,<br>random’ | √ <i>tafiʔ</i> | + <i>a...-t</i> | → | <i>a-tafiʔ</i>  | ‘one who is agape,<br>does things randomly’ |
| ‘die’              | √ <i>mate</i>  | + <i>a...-s</i> | → | <i>a-mate-s</i> | ‘dead one’                                  |
| ‘parallel’         | √ <i>tnoe</i>  | + <i>a...-s</i> | → | <i>a-tnoe-s</i> | ‘one(s) sitting opposite’                   |
| ‘sleep’            | √ <i>tupa</i>  | + <i>a...-s</i> | → | <i>a-tupa-s</i> | ‘sleeping one’                              |

One root in which the final consonant is apparently replaced by the suffixal element of *a...-t* is *munif* ‘young’ → *a-muni-t* ‘youngest one’. This is due to the final /f/ of *munif* ‘young’ being a fossilised suffix, in this case the 0GEN suffix *-f*.

When a vowel-initial root or the monosyllabic root √*ha* ‘eat (soft food)’ is nominalised with *a...-t*, the stem consists of the stative prefix *m-* (§A.2.4) attached to the third person form of the verb. Examples are given in (4) below.<sup>2</sup>

<sup>1</sup>The root √*reko* ‘good’ has irregular semantics: with *a-reko-t* ‘very good, best’.

<sup>2</sup>Evidence that it is the third person form of the verb to which the stative prefix attaches rather than having an allomorph *amn-* comes from the partially suppletive verb √*Vma* ‘come’ with the third person form *nema* and derivation *a-m-nema-t* ‘one who comes, origin’.

(4) Nominalising circumfix *a-...-t*

|          |               |                  |               |                     |                         |
|----------|---------------|------------------|---------------|---------------------|-------------------------|
| 'run'    | $\sqrt{aena}$ | + <i>a-...-t</i> | $\rightarrow$ | <i>a-m-n-aena-t</i> | 'runner'                |
| 'search' | $\sqrt{ami}$  | + <i>a-...-t</i> | $\rightarrow$ | <i>a-m-n-ami-t</i>  | 'one who searches'      |
| 'eat'    | $\sqrt{eku}$  | + <i>a-...-t</i> | $\rightarrow$ | <i>a-m-n-ekut-t</i> | 'eater (of hard food)'  |
| 'eat'    | $\sqrt{ha}$   | + <i>a-...-t</i> | $\rightarrow$ | <i>a-m-na-ha-t</i>  | 'eater (of soft food)'  |
| 'come'   | $\sqrt{Vma}$  | + <i>a-...-t</i> | $\rightarrow$ | <i>a-m-nema-t</i>   | 'one who comes, origin' |

In this case the third person prefix usually fills the first C-slot of the foot while the prefix combination *a-m-* form a syllable separate to the foot. The prosodic and morphological structures of *amnamit* 'one who searches', *amnahat* 'eater', and *amnemat* 'one who comes, origin' are shown in (5)–(7) below for comparison.

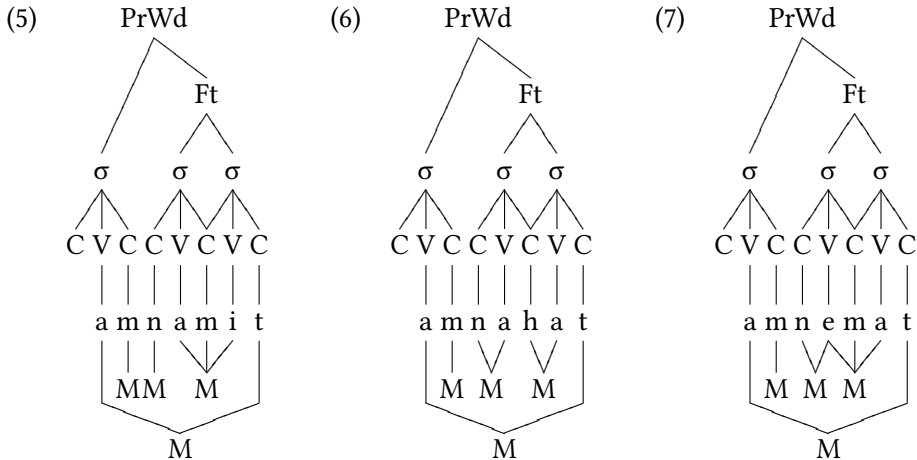
A.2.2 Property *ma-...-?*

Amarasi *ma-...-?* attaches to verbal and nominal roots to form property nouns. For nominal roots, the new word typically describes particular characterisation by the presence of the root noun, while for verbs it typically describes the resulting state of the verb. When the stem to which this circumfix attaches ends in a vowel sequence, the final glottal stop occurs as an infix between these two vowels. Examples of *ma-...-?* are given in (8) below.

(8) Property circumfix *ma...-ʔ*

|               |               |                    |                  |                          |
|---------------|---------------|--------------------|------------------|--------------------------|
| ‘rock, stone’ | <i>fatu</i>   | + <i>ma...-ʔ</i> → | <i>ma-fatʔ</i>   | ‘rocky, stony’           |
| ‘hair’        | <i>funu-f</i> | + <i>ma...-ʔ</i> → | <i>ma-funʔ</i>   | ‘hairy’                  |
| ‘wing’        | <i>niniʔ</i>  | + <i>ma...-ʔ</i> → | <i>ma-niniʔ</i>  | ‘winged’                 |
| ‘key’         | <i>retuʔ</i>  | + <i>ma...-ʔ</i> → | <i>ma-retʔ</i>   | ‘locked’                 |
| ‘thorn’       | <i>aikaʔ</i>  | + <i>ma...-ʔ</i> → | <i>ma-ʔaikaʔ</i> | ‘thorny’                 |
| ‘price’       | <i>osa-f</i>  | + <i>ma...-ʔ</i> → | <i>ma-ʔosaʔ</i>  | ‘expensive,<br>valuable’ |
| ‘hear’        | <i>√nena</i>  | + <i>ma...-ʔ</i> → | <i>ma-nenaʔ</i>  | ‘heard’                  |
| ‘call, name’  | <i>√teka</i>  | + <i>ma...-ʔ</i> → | <i>ma-tekaʔ</i>  | ‘famous,<br>well known’  |
| ‘receive’     | <i>√topu</i>  | + <i>ma...-ʔ</i> → | <i>ma-topʔ</i>   | ‘received’               |
| ‘write’       | <i>√tui</i>   | + <i>ma...-ʔ</i> → | <i>ma-tuʔi</i>   | ‘written’                |
| ‘be aware’    | <i>√keo</i>   | + <i>ma...-ʔ</i> → | <i>ma-keʔo</i>   | ‘aware’                  |

When *ma...-ʔ* attaches to a consonant-final root, the final glottal stop of this circumfix appears to replace any root final consonants, though there is only one clear putative example: *puaʔ* ‘betel-nut’ → *ma-puaʔ* ‘exchanging betel-nut’. This example may involve the reciprocal prefix *ma-* (§A.1.2).<sup>3</sup>

When *ma...-ʔ* attaches to a vowel-initial root, the stem consists of the stative prefix *m-* (§A.2.4) attached to the third person form of the verb. However, there is only one clear example in my corpus: *√ita* ‘see’ → *ma-m-n-itaʔ* ‘visible’.

There are also 36 property nominals in my corpus which begin with /ma/ but which have no corresponding root without initial /ma/. Many, but not all, of these forms also end in /ʔ/. Examples are given in (9).

(9) Frozen property prefix

|                 |            |                 |            |
|-----------------|------------|-----------------|------------|
| <i>mahataʔ</i>  | ‘itchy’    | <i>mainikin</i> | ‘cold’     |
| <i>maʔsenoʔ</i> | ‘spicy’    | <i>maʔfenaʔ</i> | ‘heavy’    |
| <i>makoe</i>    | ‘diligent’ | <i>masʔekiʔ</i> | ‘slippery’ |

There are also a number of property nominals with initial /ma/ which *do* have a corresponding root, but either the property nominal or root has undergone semantic shift such that the semantic link between the two is no longer regular. One such example is the nominal *maputuʔ* ‘hot’ which is connected with *putuʔ* ‘charcoal’.

<sup>3</sup>Culturally, betel-nut is chewed by all parties before any social gathering. Thus, *ma-puaʔ* ‘exchanging betel-nut’ is used metaphorically to mean ‘preface, prelude, introduction’.



Of such /ma/ initial nominals there are eleven which have a corresponding semantically related causative verb in which the initial /ma/ is replaced by /ha/, a reflex of the Proto-Malayo-Polynesian causative prefix \*pa-. These eleven words are given in Table A.4 below. Some of the resulting verbs also take the transitive suffix *-b* (§A.3.2).

Table A.4: Property nominals with *ha* initial causatives<sup>†</sup>

| Nominal         |                      | Causative Verb     |                                 |
|-----------------|----------------------|--------------------|---------------------------------|
| <i>mai?nisi</i> | ‘repugated by’       | <i>n-hai?nisi</i>  | ‘repels s.o.’                   |
| <i>mai?nura</i> | ‘feeble’             | <i>n-hai?nura</i>  | ‘enfeeble’                      |
| <i>mainikin</i> | ‘cold’               | <i>n-hainiki</i>   | ‘cool down (tr.)’               |
| <i>mainuan</i>  | ‘open’               | <i>n-hainua-b</i>  | ‘make open’                     |
| <i>ma?eki?</i>  | ‘fine, smooth’       | <i>n-ha?eki</i>    | ‘smoothen’                      |
| <i>ma?fena?</i> | ‘heavy’              | <i>n-ha?fena-b</i> | ‘weigh down’                    |
| <i>ma?kafa?</i> | ‘light’              | <i>n-ha?kafa</i>   | ‘lighten’                       |
| <i>ma?tani?</i> | ‘excessive, earnest’ | <i>n-ha?tani</i>   | ‘strengthen, motivate’          |
| <i>maputu?</i>  | ‘hot’                | <i>n-haputu</i>    | ‘heat up (tr.)’                 |
| <i>marine</i>   | ‘happy’              | <i>n-harine-b</i>  | ‘make happy’                    |
| <i>ma?mu?i</i>  | ‘poor’               | <i>n-ha?mu?i</i>   | ‘cause difficulty’ <sup>‡</sup> |

<sup>†</sup> When verbs are derived from nominals, any root final consonant is deleted. This is a regular process in Amarasi and is described in more detail in §6.2.1.

<sup>‡</sup> The putative (historic) root of both these forms is  $\sqrt{mu?i}$  ‘have, own’. This root may be the source of Amarasi *mu?it* ‘animal’, which would be a regular nominalisation of  $\sqrt{mu?i}$  (§A.3.3). The word *mu?it* refers to animals which are domesticated, or have the potential to be domesticated. The possession of livestock is a sign of wealth in Timor and provides a highly plausible semantic pathway between  $\sqrt{mu?i}$  ‘have’ and *mu?it* ‘(domestic) animal’. However, the existence of the Helong words *hmukit* ‘(domestic) animal’ and Dhao *mukit* ‘animal’ may caution against establishing Amarasi *mu?it* ‘animal’ as being historically derived from  $\sqrt{mu?i}$  ‘have, own’.

This alternation is no longer productive. For most property nominals which begin with /ma/, a corresponding causative verb can be derived through addition of the transitive suffix *-b* (§A.3.2). Two examples are *makoe* ‘diligent’ → *n-makoe-b* ‘makes s.o. diligent’ and *mainuki?* ‘young’ → *n-mainuki-b* ‘makes s.o. young’.

### A.2.3 Nominalising ?-...-?

The circumfix ?-...-? typically derives nouns which refer to physical objects, often tools, from verbs. When this circumfix attaches to a surface CVCV root, the initial

## A Affixal morphology sketch

element occurs as a prefix and the second element as a suffix. Examples are given in (10) below.

### (10) Nominalising circumfix $ʔ...-ʔ$

|         |       |   |       |   |          |              |
|---------|-------|---|-------|---|----------|--------------|
| ‘grate’ | √fona | + | ʔ...ʔ | → | ʔ-fona-ʔ | ‘grater’     |
| ‘bind’  | √futu | + | ʔ...ʔ | → | ʔ-futu-ʔ | ‘cloth band’ |
| ‘sit’   | √toko | + | ʔ...ʔ | → | ʔ-toko-ʔ | ‘chair’      |
| ‘sweep’ | √sapu | + | ʔ...ʔ | → | ʔ-sapu-ʔ | ‘broom’      |

When this circumfix occurs on a root with a final vowel sequence, the second glottal stop occurs between these two vowels as an infix. Examples are given in (11) below. The behaviour of this circumfix when it attaches to a surface CVCVC or CVVC root is currently unknown due to my non-exhaustive data.<sup>4</sup>

### (11) Nominalising circum-/infix $ʔ...⟨ʔ⟩$

|         |      |   |       |   |          |                     |
|---------|------|---|-------|---|----------|---------------------|
| ‘cover’ | √neo | + | ʔ...ʔ | → | ʔ-ne⟨ʔ⟩o | ‘umbrella’          |
| ‘pound’ | √pau | + | ʔ...ʔ | → | ʔ-pa⟨ʔ⟩u | ‘mortar and pestle’ |
| ‘exit’  | √poi | + | ʔ...ʔ | → | ʔ-po⟨ʔ⟩i | ‘exit (noun)’       |
| ‘sing’  | √sii | + | ʔ...ʔ | → | ʔ-si⟨ʔ⟩i | ‘song’              |
| ‘write’ | √tui | + | ʔ...ʔ | → | ʔ-tu⟨ʔ⟩i | ‘pen, pencil’       |

In addition to productive uses, there are 50 nominal roots in my corpus which appear to have a fossil of this circumfix attached. Of these roots, 70% (35/50) refer to physical entities which are of a size or shape such that they could be held in one hand, such as tools, containers, or fruit. Examples of roots which appear to have a fossil of  $ʔ...-ʔ$  are given in (12) below.

### (12) Roots with putative fossil of the nominalising circumfix $ʔ...-ʔ$

|        |                  |        |                      |
|--------|------------------|--------|----------------------|
| ʔfaneʔ | ‘hammer’, ‘bowl’ | ʔmukiʔ | ‘lime (fruit)’       |
| ʔfiʔu  | ‘sling’          | ʔnisaʔ | ‘gewang palm seed’   |
| ʔkaroʔ | ‘sack’           | ʔsoʔo  | ‘rice planting tool’ |

## A.2.4 Stative $m...-ʔ$

The stative circumfix  $m...-ʔ$  does not appear to be very productive in Amarasī, though the prefixal element  $m-$  co-occurs regularly with the nominalising circumfix  $a...-t$  (§A.2.1) and property circumfix  $ma...-ʔ$  (§A.2.2) when these circumfixes attach to vowel-initial stems. Stative  $m-$  attaches to verbal roots and

<sup>4</sup>Comparison with the property circumfix  $ma...-ʔ$  (§A.2.2) indicates that the suffixal element of this nominaliser would probably replace the final consonant of such roots.

derives forms for which the subject has a more patient-like semantic role. Examples of statives derived with this affix are given in (13) below.

(13) Stative verbs with *m-*

|                       |               |             |   |                  |                       |
|-----------------------|---------------|-------------|---|------------------|-----------------------|
| ‘finish’              | $\sqrt{sopu}$ | + <i>m-</i> | → | <i>na-m-sopu</i> | ‘is finished’         |
| ‘loose’               | $\sqrt{neku}$ | + <i>m-</i> | → | <i>na-m-neku</i> | ‘is lost’             |
| ‘stand upright’       | $\sqrt{tetu}$ | + <i>m-</i> | → | <i>na-m-tetu</i> | ‘is standing upright’ |
| ‘set, place’          | $\sqrt{teke}$ | + <i>m-</i> | → | <i>na-m-teke</i> | ‘is set/placed’       |
| ‘straighten, correct’ | $\sqrt{nono}$ | + <i>m-</i> | → | <i>m-nono-ʔ</i>  | ‘straight, correct’   |

This circumfix is clearly related to the property circumfix *ma-...-ʔ* (§A.2.2) and the prefixal elements of both these circumfixes are reflexes of Proto-Malayo-Polynesian \**ma-* ‘stative verb prefix’ Blust (2003: 473).

When vowel-initial roots or the monosyllabic root  $\sqrt{ha}$  ‘eat (soft food)’ occur with this prefix, the stem takes the third person form. Examples are given in (14) below. Not all these forms clearly have a stative meaning. This is additional evidence that this prefix is no longer productive.

(14) Statives with *m-n-*

|          |                |             |   |                  |                       |
|----------|----------------|-------------|---|------------------|-----------------------|
| ‘praise’ | $\sqrt{aikas}$ | + <i>m-</i> | → | <i>m-n-aikas</i> | ‘praise’ (nominal)    |
| ‘drink’  | $\sqrt{inu}$   | + <i>m-</i> | → | <i>m-n-inu-ʔ</i> | ‘drinking, drinkable’ |
| ‘see’    | $\sqrt{ita}$   | + <i>m-</i> | → | <i>m-n-ita-ʔ</i> | ‘seen, visible’       |

The final glottal stops in *na-m-n-inu-ʔ* ‘drinking, drinkable’, *m-n-ita-ʔ* ‘seen, visible’, and *m-nono-ʔ* ‘straight, correct’ provide evidence that the stative affix is indeed a circumfix *m-...-ʔ* rather than simply a prefix *m-*. The failure of this glottal stop to appear on other forms in (13) and (14) can be ascribed to them either being consonant final (e.g. *aikas* ‘praise’) or because they are verbs. Final consonants of nominals are regularly deleted when they are the base for verbal derivation (§6.2.1).

The eight words given in (13) and (14) are the only forms in my corpus for which a clearly related root without the stative circumfix has been identified. There are also eleven property nominals in my corpus which begin with /mC/ for which there is no corresponding synchronic form without this initial /m/. Of these, half (6/11) also end with /ʔ/. These eleven forms are: *mnaaʔ* ‘old, former, previous’, *mnasiʔ* ‘old, aged’, *mnanuʔ* ‘long, deep, length, depth’, *mnee* ‘calm’,  $\sqrt{mnees}$  → *mnees-a|mnees* ‘quiet’, *mfaun* ‘many’, *mneo* ‘straight, erect; really, truly’, *mneraʔ* ‘flat, wide open valley’, *mnutuʔ* ‘fine, tiny’, *mnuʔir* ‘wrinkled’, and *mtasaʔ* ‘cooked, ripe’.

### A.3 Suffixes

Kotos Amarasi does not allow word-final consonant clusters. Thus, the addition of consonantal suffixes to consonant-final roots is not straightforward. Such clusters are avoided through deletion of the root final consonant, using an allomorph of the suffix which contains a vowel, or by not using the suffix.

#### A.3.1 Genitive suffixes

The genitive suffixes are given in Table A.5 below. These suffixes only occur on nouns which are in a part-whole relationship with the “possessor”. Such nouns in turn occur almost obligatorily with a genitive suffix. Examples of each of these suffixes on a number of nouns are given in Table A.6. The use of the genitive suffixes is discussed in more detail in §6.4.2.

Table A.5: Kotos Amarasi genitive suffixes

|     | SG | PL |
|-----|----|----|
| 1   | -k | -m |
| 1,2 |    | -k |
| 2   | -m | -m |
| 3   | -n | -k |
| 0   |    | -f |

Table A.6: Body parts with genitive suffixes (Grimes et al. 2012: 7)

|     |             | ‘body’      | ‘spirit’       | ‘eye’         | ‘foot, leg’  | ‘ear’         | ‘face’        |
|-----|-------------|-------------|----------------|---------------|--------------|---------------|---------------|
| 0   |             | <i>ao-f</i> | <i>smana-f</i> | <i>mata-f</i> | <i>hae-f</i> | <i>ruki-f</i> | <i>huma-f</i> |
| 1SG | <i>au</i>   | <i>ao-k</i> | <i>smana-k</i> | <i>mata-k</i> | <i>hae-k</i> | <i>ruki-k</i> | <i>huma-k</i> |
| 2SG | <i>hoo</i>  | <i>ao-m</i> | <i>smana-m</i> | <i>mata-m</i> | <i>hae-m</i> | <i>ruki-m</i> | <i>huma-m</i> |
| 3SG | <i>iin</i>  | <i>ao-n</i> | <i>smana-n</i> | <i>mata-n</i> | <i>hae-n</i> | <i>ruki-n</i> | <i>huma-n</i> |
| 1IN | <i>hiit</i> | <i>ao-k</i> | <i>smana-k</i> | <i>mata-k</i> | <i>hae-k</i> | <i>ruki-k</i> | <i>huma-k</i> |
| 1EX | <i>hai</i>  | <i>ao-m</i> | <i>smana-m</i> | <i>mata-m</i> | <i>hae-m</i> | <i>ruki-m</i> | <i>huma-m</i> |
| 2PL | <i>hii</i>  | <i>ao-m</i> | <i>smana-m</i> | <i>mata-m</i> | <i>hae-m</i> | <i>ruki-m</i> | <i>huma-m</i> |
| 3PL | <i>siin</i> | <i>ao-k</i> | <i>smana-k</i> | <i>mata-k</i> | <i>hae-k</i> | <i>ruki-k</i> | <i>huma-k</i> |

The “0 person” suffix *-f* occurs when the possessor is irrelevant to the discourse, or it is not in a part-whole relationship, or its association is not in focus. This includes the citation form, amputation, or when the part is being talked about in generic terms (Grimes et al. 2012). On kin terms the suffix *-f* has a different function, discussed in §A.3.1.1 below.

I have collected less than a dozen words which contain a vowel medial glottal stop when no genitive suffix is attached, and contain a vowel sequence when a genitive suffix is attached. These words are given in (15) below with both unsuffixed and suffixed forms.<sup>5</sup> When the words in (15) have known Proto-Malayo-Polynesian reflexes, this medial glottal stop is not an inheritance from any reconstructed consonant. (See §3.3.7.6.2 for more details.)

(15)  $V?V \leftrightarrow VV-C_{\text{GEN}}$

|             |               |                   |                                                 |
|-------------|---------------|-------------------|-------------------------------------------------|
| <i>taʔe</i> | + <i>-f</i> ↔ | <i>tae-f</i>      | ‘a branch’                                      |
| <i>haʔe</i> | + <i>-m</i> ↔ | <i>hoo hae-m</i>  | ‘your leg’                                      |
| <i>noʔo</i> | + <i>-k</i> ↔ | <i>siin noo-k</i> | ‘their leaves’                                  |
| <i>uʔu</i>  | + <i>-n</i> ↔ | <i>iin uu-n</i>   | ‘its source’                                    |
| <i>baʔe</i> | + <i>-f</i> ↔ | <i>bae-f</i>      | ‘same sex male cross cousin’                    |
| <i>beʔi</i> | + <i>-f</i> ↔ | <i>bei-f</i>      | ‘grandmother’                                   |
| <i>naʔo</i> | + <i>-f</i> ↔ | <i>nao-f</i>      | ‘woman’s brother’                               |
| <i>koʔu</i> | + <i>-f</i> ↔ | <i>aam kou-f</i>  | ‘father’s older brother’<br>(lit. ‘big father’) |
| <i>koʔu</i> | + <i>-f</i> ↔ | <i>ain kou-f</i>  | ‘mother’s older sister’<br>(lit. ‘big mother’)  |
| <i>feʔu</i> | + <i>-f</i> ↔ | <i>moen feu-f</i> | ‘son-in-law’ (lit. ‘new male’)                  |

While the medial glottal stop of *koʔu* ‘big’ is deleted in the phrases *aam kou-f* ‘father’s elder brother’ and *ain kou-f* ‘mother’s elder sister’, in the phrase *keo koʔu-f* ‘Achille’s tendon’ (from *keo-* ‘vein’ + *koʔu*) it is retained.

Historically, the medial glottal stop in such forms is a nominal suffix which has metathesised with the final vowel. This suffix is attested in the Rote languages, as seen in for instance in Termanu *beu-k*, Dengka *feu-ʔ* ‘new’, Amarasi *feʔu* ‘new’, Termanu *doo-k*, Dengka *loo-ʔ*, Amarasi *noʔo* ‘leaf’, and Termanu *hoo-k*, Dengka *hoo-ʔ*, Amarasi *uʔu* ‘tree trunk, source’.

With the exception of the words given in (15), other words with a medial glottal stop retain this glottal stop when a genitive suffix occurs. In such cases the medial

<sup>5</sup>In addition to the forms given in (15) there are two Ro’is Amarasi terms which are also known to exhibit such medial glottal stop deletion. These are *tuuhaʔo* → *tuuhao-f* ‘same sex sibling’ and *maʔo* → *aam mao-f* ‘father’s younger brother’ or *ain mao-f* ‘mother’s younger sister’.

glottal stop is a retention of an earlier root-medial consonant. Two examples are Amarasi *naʔi-f* ‘grandfather’, which is from Proto-Malayo-Polynesian \*laki ‘man, male’, and *?baʔa-f* ‘roots’ which can be compared with Funai Helong *kbakat* ‘roots’, possibly irregular reflexes of Proto-Malayo-Polynesian \*wakaR.

### A.3.1.1 Kin terms

Kin relations take a different set of genitive suffixes to other nouns. In “normal” Amarasi, kin relations take the suffix *-f* when the possessor is 3SG and take no suffix with other possessors or when the stem is not possessed. When the possessor is 3PL there is variation between no-suffix and *-f*

The “normal” Amarasi kin genitive paradigm is given in Table A.7a. These are the forms used, for instance, in the Amarasi Bible translation in order to avoid forms specific to a particular dialect. In the village of Koro'oto (where most of my data was gathered) the suffix *-f* is used on all possessed kin relations. The Koro'oto kin genitive suffixes are given in Table A.7b.

Table A.7: Kin possessive paradigms

| (a) General Kotos Amarasi |           |              | (b) Koro'oto hamlet |           |              |
|---------------------------|-----------|--------------|---------------------|-----------|--------------|
|                           | SG        | PL           |                     | SG        | PL           |
| 1                         | ∅         | ∅            | 1                   | <i>-f</i> | <i>-f</i>    |
| 1,2                       |           | ∅            | 1,2                 |           | <i>-f</i>    |
| 2                         | ∅         | ∅            | 2                   | <i>-f</i> | <i>-f</i>    |
| 3                         | <i>-f</i> | ∅/ <i>-f</i> | 3                   | <i>-f</i> | <i>-f</i>    |
| 0                         |           | ∅/ <i>-f</i> | 0                   |           | ∅/ <i>-f</i> |

The (Kotos) Amarasi kin terms which have been attested with these possessive paradigms are given in Table A.8. Nearly all kin terms have a medial or final glottal stop which is deleted when the suffix *-f* is attached.<sup>6</sup> Noun phrases in which one of these kin terms is the head noun also take genitive suffixes, thus for instance, *ama-f* ‘father’ + *koʔu* ‘big’ → *aam kou-f* ‘father’s older brother’. Not all words which are semantically kin terms take kin genitive suffixes. Three examples are *anah* ‘child’, *mone* ‘husband’ and *fee* ‘wife’.

<sup>6</sup>An alternate analysis of the data is to analyse this glottal stop as an affix which would replace the cells filled with ∅ in Table A.7a. However, under this analysis we cannot explain why *naʔi* ‘grandfather’ and *kaʔo* ‘ancestor’ do not take this putative *-ʔ* affix when *-f* does not occur.

Table A.8: Kotos Amarasi kin terms with genitive suffixes

| Amarasi                     |                   | Gloss             | meaning                                                                                                       |
|-----------------------------|-------------------|-------------------|---------------------------------------------------------------------------------------------------------------|
| <i>naʔi</i>                 | <i>naʔi-f</i>     | PF                | ‘grandfather’                                                                                                 |
| <i>beʔi</i>                 | <i>bei-f</i>      | PM                | ‘grandmother’                                                                                                 |
| <i>kaʔo</i> <sup>†</sup>    |                   | PPP               | ‘ancestor’                                                                                                    |
| <i>amaʔ</i>                 | <i>ama-f</i>      | F                 | ‘father, father’s brother’                                                                                    |
| <i>ainaʔ</i>                | <i>aina-f</i>     | M                 | ‘mother, mother’s sister’                                                                                     |
| <i>babaʔ</i>                | <i>baba-f</i>     | MB/FZ             | ‘parent’s opposite sex sibling’                                                                               |
| <i>bitoroʔ</i> <sup>‡</sup> |                   | MB                | ‘mother’s brother’                                                                                            |
| <i>tataʔ</i>                | <i>tata-f</i>     | eSi               | ‘same sex elder sibling’                                                                                      |
| <i>oriʔ</i>                 | <i>ori-f</i>      | ySi               | ‘same sex younger sibling’                                                                                    |
| <i>naʔo</i>                 | <i>nao-f</i>      | fB                | ‘woman’s brother’                                                                                             |
| <i>fetoʔ</i>                | <i>feto-f</i>     | mZ                | ‘man’s sister’                                                                                                |
| <i>moen feʔu</i>            | <i>moen feu-f</i> | DH                | ‘daughter’s husband,<br>opposite sex sibling’s son’                                                           |
|                             | <i>nane-f</i>     | SW                | ‘son’s wife, opposite<br>sex sibling’s daughter’                                                              |
| <i>baʔe</i>                 | <i>bae-f</i>      | WB/ZH/<br>MBD/FZS | 1) ‘same sex cross-cousin, same sex sibling<br>of spouse, opposite sex sibling’s spouse’<br>2) ‘mate, friend’ |
| <i>upuʔ</i>                 | <i>upu-f</i>      | CC                | ‘grandchild’                                                                                                  |
| <i>uup kaʔo</i>             | <i>uup kaʔo-f</i> | CCC               | ‘great-grandchild’                                                                                            |

<sup>†</sup> *kaʔo* ‘ancestor’ and *bitoroʔ* ‘mothers’ brother have not yet been attested with a 3sg possessor and the suffix *-f*. *nane-f* ‘daughter in law’ has not yet been attested without the suffix *-f*.

<sup>‡</sup> *bitoroʔ* ‘maternal uncle’ is specific to Koro'oto hamlet and had the variant *toroʔ*. Some varieties of Kopas have *toloʔ* ‘maternal uncle’.

Examples of the “normal” paradigm for kin terms are given in (16)–(19) below. Most such examples I have encountered occur in the Amarasi Bible translation.

- (16) *au babaʔ na-mena =m et uam menas*  
 1SG FZ/MB 3-sick =and 1PFV.LOC house sick  
 ‘My aunt was sick and in the hospital.’ 130825-6, 17.22 🗣️
- (17) *hoo ro he m-hormaat hoo ainaʔ =ma hoo amaʔ.*  
 2SG must IRR 1PX/2-honour 2SG mother =and 2SG father  
 ‘You must honour your mother and your father.’ Ephesians 6:2

A Affixal morphology sketch

- (18) *mes hoo m-ak iin re? ia, hoo feto?!*  
 but 2SG 1PX/2-say 3SG REL IDEM 2SG mZ  
 ‘But you said that she is your sister!’ Genesis 12:19
- (19) *nai? Yakop naan, iin feto-f bi Ripka anah*  
 Mr. Jacob 2DEM 3SG mZ-GEN Ms. Rebecca child  
 ‘Jacob<sub>i</sub> was the son of his<sub>j</sub> sister Rebecca.’ Genesis 29:13

Examples of the Koro'oto general kin suffix *-f* are given in (20) and (21) below.

- (20) *au feto-f nee memaη iin n-sadar.*  
 1SG mZ-GEN 3DEM indeed 3SG 3-aware  
 ‘My sister there certainly was aware.’ 130825-6, 3.43 🔊
- (21) *hoo feat-f=ii bi sekau?*  
 2SG mZ-GEN=ii Ms. who  
 ‘Who’s your sister?/What’s your sister’s name?’ 130825-6, 2.06 🔊

A.3.1.2 Ro'is possession

Ro'is Amarasi has a different set of possessive suffixes compared with Kotos. The Ro'is genitive suffixes are given in Table A.9. Ro'is does not have a separate paradigm for kin relations and kin terms either take no suffix or take the suffixes given in Table A.9.

Table A.9: Ro'is Amarasi genitive suffixes

|     | SG           | PL           |
|-----|--------------|--------------|
| 1   | <i>-k</i>    | <i>-m</i>    |
| 1,2 |              | <i>-k/-r</i> |
| 2   | <i>-m</i>    | <i>-m</i>    |
| 3   | <i>-n/-r</i> | <i>-n/-r</i> |
| 0   |              | <i>-f</i>    |

The third person suffix *-r* is used when the thing possessed is plural and *-n* is used when the thing possessed is singular. This means that for these persons the suffix indexes the person of the possessor and the number of the possessum. Elicited examples are given in (22)–(25) below which shows each combination of a singular possessor and plural possessum. In these examples P<sub>SR</sub> is used for *possessor* and P<sub>SM</sub> is used for *possessum* (the thing possessed).



- (22) *hiin maat-n=ee*  
3SG eye-3PSR;SG.PSM=3DET  
'her/his eye'
- (23) *hiin maat-r=iin*  
3SG eye-3PSR;PL.PSM=PL  
'her/his eyes'
- (24) *siin moin-n=ee*  
3PL life-3PSR;SG.PSM=3DET  
'their life'
- (25) *siin moin-r=iin*  
3PL life-3PSR;PL.PSM=PL  
'their lives'

The ungrammatical example in (26) below shows that the singular possessum suffix *-n* cannot co-occur with the plural enclitic *=iin*. The ungrammaticality of (27) arises from the suffix *-r* marking the possessum *ha?e* 'leg/foot' as plural in combination with real world knowledge that people only have two legs.<sup>7</sup>

- (26) \* *hiin maat-n=iin*  
3SG eye-3PSR;SG.PSM=PL  
'(her/his eyes)'
- (27) \* *hiin hae-r*                      *bian=ee*  
3SG leg-3PSR;PL.PSM other=3DET  
'(her/his other legs)'

An example from a text with a singular referent possessing a plural possessum which in turn possesses a singular referent is given in (28) below.

- (28) *hiin maat-r=ini*                      *poun-n=ii*                      *msa? muti? oke?*  
3SG eye-3PSR;PL.PSM=PL hair-3PSR;SG.PSM=1DET also white all  
'The hair of the eyes of it (that tribe) are also all white.' R0-170822-3, 2.12  
▶▶

That the use of *-r* to index plural possessums is not exclusive to entities which naturally come in groups (such as eyes, legs etc.), is shown in (29) below in which both *feto?* 'man's sister' and *tuuha?o* 'brother' each occur with the suffix *-r* despite having a singular possessor.

- (29) a. *hiin feot-r=iin*                      *ma-, mana?, feot-n=ii*                      *mese?*  
3SG mS-3PSR;PL.PSM=PL                      COUNT mS-3PSR;SG.PSM=1DET one  
'He had sisters, umm, one sister.'  
*lit.* 'His sisters were, (his) sister was one.' R0-170917-1, 8.06 ▶▶

<sup>7</sup>Presumably the phrase *hiin hae-r bian=iin* 'its other legs' could be used with reference to an animal with multiple legs, but this has not yet been tested.



(34) Transitive suffix *-b*

|             |                 |   |           |   |                   |                 |
|-------------|-----------------|---|-----------|---|-------------------|-----------------|
| ‘ascends’   | <i>n-sae</i>    | + | <i>-b</i> | → | <i>na-sae-b</i>   | ‘raises sth.’   |
| ‘sits’      | <i>n-took</i>   | + | <i>-b</i> | → | <i>na-toko-b</i>  | ‘makes sit’     |
| ‘name’      | <i>kana-f</i>   | + | <i>-b</i> | → | <i>na-kana-b</i>  | ‘names s.o.’    |
| ‘remembers’ | <i>na-mnau</i>  | + | <i>-b</i> | → | <i>na-mnau-b</i>  | ‘reminds s.o.’  |
| ‘stops’     | <i>na-snaas</i> | + | <i>-b</i> | → | <i>na-snasa-b</i> | ‘stops s.o.’    |
| ‘goes’      | <i>n-nao</i>    | + | <i>-b</i> | → | <i>na-nao-b</i>   | ‘makes s.o. go’ |

(35) Transitive suffix *-ʔ*

|           |               |   |           |   |                  |                   |
|-----------|---------------|---|-----------|---|------------------|-------------------|
| ‘good’    | <i>reko</i>   | + | <i>-ʔ</i> | → | <i>na-reko-ʔ</i> | ‘fixes’           |
| ‘stands’  | <i>n-haek</i> | + | <i>-ʔ</i> | → | <i>na-hake-ʔ</i> | ‘establishes’     |
| ‘returns’ | <i>n-fain</i> | + | <i>-ʔ</i> | → | <i>na-fani-ʔ</i> | ‘returns to s.o., |
|           | <i>n-fain</i> | + | <i>-ʔ</i> | → | <i>na-fani-ʔ</i> | repeats sth.’     |

I have also collected two intransitive verbs which have a transitive counterpart which ends in a final /s/. These are *na-mtau* ‘scared’ with *na-mtaus* ‘scared of’ and *n-mani* ‘laugh’ with *n-manis* ‘laugh at’.<sup>10</sup>

In the case of *na-mtaus* ‘scared of’ the final consonant may be a retention of the original final \*t of Proto-Malayo-Polynesian \*takut, with application of the rule realising suffixal *-t* as *-s* after roots which contain a /t/ (§A.3.3). However, such an explanation is not possible for *n-manis* ‘laugh at’, from Proto-Central-Eastern Malayo-Polynesian \*malip (Blust & Trussel ongoing).

A.3.3 Nominalising *-t*

The suffix *-t* is a nominaliser which derives nouns from verbs. The nouns derived refer to the activity of the verb or the results of this activity. The suffix *-t* has the allomorph *-s* after stems which contain a /t/, and is related to the suffixal element of the nominalising circumfix *a-...-t* (§A.2.1). This suffix has not yet been clearly attested on consonant-final roots. Examples of *-t* and its allomorph *-s* are given in (36) below.<sup>11</sup>

<sup>10</sup>Somewhat unusually, transitive *n-manis* ‘laugh at’ does not take vocalic prefixes. (§A.1.1).

<sup>11</sup>The word pair *n-mena* ‘sick’ and *menas* ‘sickness’ appear to represent a root which irregularly takes the allomorph *-s* despite the lack of any /t/. However, a comparison with cognate forms in related languages, such as Tetun *moras* ‘to be sick, to be in poor health’ (Morris 1984: 143) – ultimately both reflexes of Proto-Malayo-Polynesian \*ma-hapəjəs – reveals that the Amarasi root is actually the consonant-final nominal  $\sqrt{menas}$  ‘sickness’, from which the verb *n-mena* ‘sick’ is derived via the regular process of root final consonant deletion (§6.2.1).

## A Affixal morphology sketch

### (36) Nominalising suffix *-t*

|                          |                 |               |                 |                    |
|--------------------------|-----------------|---------------|-----------------|--------------------|
| ‘speak poetically’       | √ <i>ʔaʔa</i>   | + <i>-t</i> → | <i>ʔaʔa-t</i>   | ‘poetry’           |
| ‘do, make’               | √ <i>moʔe</i>   | + <i>-t</i> → | <i>moʔe-t</i>   | ‘deed, act’        |
| ‘live’                   | √ <i>moni</i>   | + <i>-t</i> → | <i>moni-t</i>   | ‘life’             |
| ‘believe’                | √ <i>pirsai</i> | + <i>-t</i> → | <i>pirsai-t</i> | ‘belief, religion’ |
| ‘speak foreign language’ | √ <i>rabi</i>   | + <i>-t</i> → | <i>rabi-t</i>   | ‘foreign language’ |
| ‘sing’                   | √ <i>sii</i>    | + <i>-t</i> → | <i>sii-t</i>    | ‘song’             |
| ‘die’                    | √ <i>mate</i>   | + <i>-s</i> → | <i>mate-s</i>   | ‘death’            |
| ‘stand upright’          | √ <i>tetu</i>   | + <i>-s</i> → | <i>tetu-s</i>   | ‘blessing’         |
| ‘ask’                    | √ <i>toti</i>   | + <i>-s</i> → | <i>toti-s</i>   | ‘request’          |
| ‘marry’                  | √ <i>matsao</i> | + <i>-s</i> → | <i>matsao-s</i> | ‘marriage’         |

### A.3.4 People group suffix *-s*

The suffix *-s* forms nouns referring to people groups. After CVC# final stems this suffix replaces the final consonant, while after VVC# final stems this suffix has the allomorph *-as*. These allomorphs mean that the final foot of the derived people group noun fills the CVCVC foot structure (§3.3.2), with examples such as *Naet-as* ‘person from *Naet*’ having the initial vowel sequence assigned to a single V-slot (§3.4.1.1). Examples of *-s* are given in (37) below.

### (37) People group suffix *-s*

|            |                   |                |                      |                           |
|------------|-------------------|----------------|----------------------|---------------------------|
| ‘Sabu’     | <i>Sapu</i>       | + <i>-s</i> →  | <i>Sapu-s</i>        | ‘person from Sabu’        |
| ‘Rote’     | <i>Rote</i>       | + <i>-s</i> →  | <i>Rote-s</i>        | ‘person from Rote’        |
| ‘Koro’oto’ | <i>Koorʔoto</i>   | + <i>-s</i> →  | <i>Koorʔoto-s</i>    | ‘person from Koro’oto’    |
| ‘Belu’     | <i>Beru</i>       | + <i>-s</i> →  | <i>Beru-s</i>        | ‘person from Belu’        |
| ‘Kupang’   | <i>Kopan</i>      | + <i>-s</i> →  | <i>Kopa-s</i>        | ‘person from Kupang’      |
| ‘Helong’   | <i>ʔHeroʔ</i>     | + <i>-s</i> →  | <i>ʔHero-s</i>       | ‘Helong person’           |
| ‘Buraen’   | <i>Buraen</i>     | + <i>-as</i> → | <i>Buraen-as</i>     | ‘person from Buraen’      |
| ‘Naet’     | <i>Naet</i>       | + <i>-as</i> → | <i>Naet-as</i>       | ‘person from Naet’        |
| ‘east’     | <i>neon sae-t</i> | + <i>-as</i> → | <i>neon sae-t-as</i> | ‘easterner’ <sup>12</sup> |

<sup>12</sup>The form *neon sae-t-as* ‘easterner’ specifically refers to someone from the north-eastern Meto speaking areas; Oecusse (Baikeno), Miomafo, Insana, and Biboki.

A.3.5 The suffix *-a?*

VVC# final verbs appear to have two forms, one ending in VVC and one ending in VVCa?#. The forms ending in /a?/ do not occur before enclitics, but other than this environment both forms appear to be in free variation with one another with no difference in meaning currently apparent. Examples are given in (38) below.

(38) VVC# ~ VVCa?# alternation

|                |   |                  |                       |
|----------------|---|------------------|-----------------------|
| <i>na-baen</i> | ~ | <i>na-baena?</i> | ‘pays’                |
| <i>na-kain</i> | ~ | <i>na-kaina?</i> | ‘rebukes’             |
| <i>na-ʔuab</i> | ~ | <i>na-ʔuaba?</i> | ‘speaks’              |
| <i>na-maik</i> | ~ | <i>na-maika?</i> | ‘stay, remain behind’ |
| <i>na-tuin</i> | ~ | <i>na-tuina?</i> | ‘follows’             |

This also includes stems which are VVC# final due to the addition of a consonantal suffix to a VV# final root. Examples are given in (39) below with the transitive suffix *-b*.

(39) VV-C# ~ VV-Ca?# alternation

|               |               |                  |   |                    |                     |
|---------------|---------------|------------------|---|--------------------|---------------------|
| $\sqrt{hae}$  | + <i>-b</i> → | <i>na-hae-b</i>  | ~ | <i>na-hae-ba?</i>  | ‘tires s.o. out’    |
| $\sqrt{mnau}$ | + <i>-b</i> → | <i>na-mnau-b</i> | ~ | <i>na-mnau-ba?</i> | ‘reminds’           |
| $\sqrt{sae}$  | + <i>-b</i> → | <i>na-sae-b</i>  | ~ | <i>na-sae-ba?</i>  | ‘raises, picks up’  |
| $\sqrt{tea}$  | + <i>-b</i> → | <i>na-tea-b</i>  | ~ | <i>na-tea-ba?</i>  | ‘makes s.o. arrive’ |

The reason for this alternation is currently unknown. One hypothesis I considered was that this alternation was comparable to the alternation between U-forms and M-forms. However, the forms ending in /a?/ occur in many environments where a U-form is unexpected, such as in simple declarative sentences (Chapter 7).

One possibility is that final /a?/ occurs in order to provide such forms a complete foot with no empty medial C-slots. As discussed in §3.4.1.1, words which surface as VVCVC#, are best analysed as being assigned a CVCVC foot with the initial two vowels being assigned to a single V-slot, as illustrated for *na-maika?* ‘stay, remain behind’ in (40) below. Forms without a final /a?/ on the other hand would have an empty medial C-slot, as illustrated in (41) below.

*A Affixal morphology sketch*

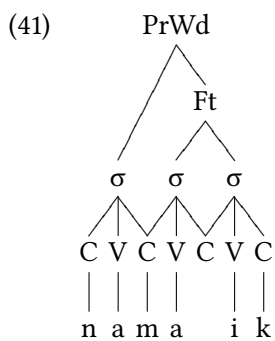
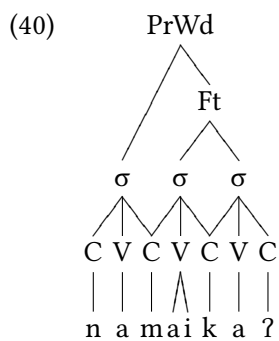

If it is the case that the suffix /aʔ/ occurs to provide words with a complete foot with only filled C-slots, then the segmental material of /aʔ/ is expected. The vowel /a/ is the default vowel in Amarasi (§3.2.1.3, §3.5) and /ʔ/ is the default consonant (§3.3.6).

# Appendix B: Survey of morphological metathesis

## B.1 Introduction

In this appendix I discuss cases of morphological metathesis not discussed in Chapter 2. That is, all cases of morphological metathesis I know of outside the Pacific and greater Timor areas. This appendix is limited to languages where metathesis has a morphological use in some cases for the simple practical reason that a list of all metathesis patterns is beyond the scope of this book.

The languages discussed in this appendix are: Tunisian Arabic (§B.2), Ohlone (§B.4), Sierra Miwok (§B.5), Svan (§B.3), Alesha (§B.6) and a number of the Salishan languages (§B.7). All of these languages, with the exception of Tunisian Arabic and Svan, are spoken in western America. A map showing the location of these American languages is given in Figure B.1.

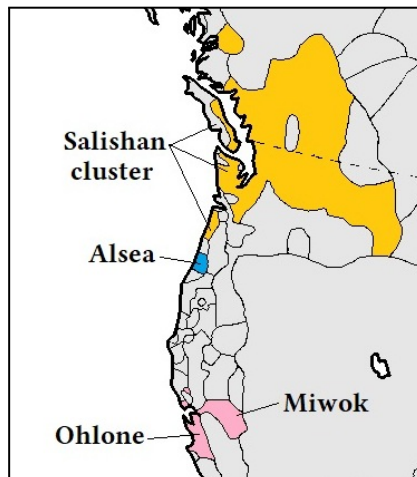

Figure B.1: Languages of west America with morphological metathesis

## B.2 Tunisian Arabic

Metathesis in Tunisian Arabic is described by Kilani-Schoch & Dressler (1986). Their discussion begins with the observation that Tunisian Arabic has a process of phonologically conditioned metathesis (§2.2.1), in which the medial CV sequence of a CCVC stem metathesises before a vowel-initial suffix. Examples are given in (1) below.

- (1) CC<sub>2</sub>V<sub>1</sub>C → CV<sub>1</sub>C<sub>2</sub>C / \_-V Kilani-Schoch & Dressler (1986: 61)

|            | Stem        | → | Suffixed Form   |              |
|------------|-------------|---|-----------------|--------------|
| ‘palms’    | <i>nxal</i> | → | <i>naxl-a</i>   | ‘a palm’     |
| ‘mountain’ | <i>ǧbəl</i> | → | <i>ǧəbl-i</i>   | ‘mountains’  |
| ‘he wrote’ | <i>ktəb</i> | → | <i>kətb-u</i>   | ‘they wrote’ |
| ‘month’    | <i>ʃħar</i> | → | <i>ʃəħr-i:n</i> | ‘two months’ |

However, there are a number of verbs in which CV → VC metathesis alone results in a nominalisation, producing what Kilani-Schoch & Dressler call a *nomen actionis* (action noun). Such metathesis only affects words of the shape CCVC. Examples are given in (2) below.

- (2) Nominalising metathesis (Kilani-Schoch & Dressler 1986: 62)

|                 | Verb          | → | Noun          |                     |
|-----------------|---------------|---|---------------|---------------------|
| ‘he understood’ | <i>ʃħəm</i>   | → | <i>fəħm</i>   | ‘understanding’     |
| ‘he was sick’   | <i>mrˆaðˆ</i> | → | <i>marˆðˆ</i> | ‘sickness’          |
| ‘he owned’      | <i>mlək</i>   | → | <i>məlk</i>   | ‘asset’             |
| ‘he lied’       | <i>kəðb</i>   | → | <i>kəðb</i>   | ‘lying’             |
| ‘he tightened’  | <i>ħsˆarˆ</i> | → | <i>ħasˆrˆ</i> | ‘act of tightening’ |
| ‘he blasphemed’ | <i>kfər</i>   | → | <i>kəfr</i>   | ‘blasphemy’         |
| ‘he prohibited’ | <i>ħrəm</i>   | → | <i>ħarm</i>   | ‘prohibition’       |

An alternate analysis of the same data would be to identify the nouns as the base from which verbs are derived by VC → CV metathesis. Kilani-Schoch & Dressler (1986) adduce both diachronic evidence as well as native speaker judgements in favour of their analysis of metathesis as a nominaliser.

Metathesis is only one of a number of nominalisation strategies in Tunisian Arabic. Another nominalisation strategy is affixation. Nominalising affixes include *-a:n*, *-(j)a*, *m(a)-* or a combination of *m...-a*. Examples are given in (3) below. Suffixation with a vowel-initial suffix also triggers phonologically conditioned metathesis of CCVC roots, as seen in (1) above.



## (3) Nominalising affixation (Kilani-Schoch &amp; Dressler 1986: 63f)

|                 | Verb          |   | Noun            |                          |
|-----------------|---------------|---|-----------------|--------------------------|
| 'he attached'   | <i>rˁbatˁ</i> | → | <i>rˁabtˁ-a</i> | 'act of attaching'       |
| 'he read'       | <i>qra</i>    | → | <i>qra:ja</i>   | 'reading'                |
| 'he blasphemed' | <i>kfər</i>   | → | <i>kəfr-a:n</i> | 'blasphemy' <sup>1</sup> |
| 'he asked'      | <i>tˁləb</i>  | → | <i>ma-tˁləb</i> | 'request'                |
| 'he loved'      | <i>ħabb</i>   | → | <i>m-ħabb-a</i> | 'act of loving'          |

Another nominalisation strategy is apophony, either replacing a short vowel with the equivalent long vowel or replacing it with a vowel of a different quality. Examples are given in (4) below.

## (4) Nominalising apophony (Kilani-Schoch &amp; Dressler 1986: 64)

|               | Verb        |   | Noun         |                   |
|---------------|-------------|---|--------------|-------------------|
| 'he slept'    | <i>rqaḍ</i> | → | <i>rqa:d</i> | 'sleep'           |
| 'he went mad' | <i>xbəl</i> | → | <i>xba:l</i> | 'going mad'       |
| 'he entered'  | <i>dxəl</i> | → | <i>dxu:l</i> | 'act of entering' |
| 'he swam'     | <i>fa:m</i> | → | <i>fu:m</i>  | 'swimming'        |
| 'he sold'     | <i>ba:ʃ</i> | → | <i>bi:ʃ</i>  | '(a) sale'        |

The final nominalisation strategy is zero derivation; that is conversion of a verb into a noun with no phonological change. Examples are given in (5) below.

## (5) Zero derivation (Kilani-Schoch &amp; Dressler 1986: 63,65)

|               |                              |
|---------------|------------------------------|
| <i>ʃməl</i>   | 'he did' ~ 'deed'            |
| <i>ʃtˁasˁ</i> | 'sneeze' ~ 'act of sneezing' |
| <i>nḍˁar</i>  | 'he saw' ~ 'seeing'          |
| <i>xbar</i>   | 'he informed' ~ 'informing'  |

Kilani-Schoch & Dressler (1986: 71) carried out two tests to determine how productive each of these nominalisation strategies were for CCVC verbs. In each case metathesis was the most productive nominalisation strategy.

In the first test speakers were presented with ten fictional verbs and a variety of nominalisations formed according to each possible process illustrated in (2)–(5) above. Metathesis was the preferred strategy in 8/10 instances in the first run of this test and was preferred in 9/10 instances in the second run.<sup>2</sup>

<sup>1</sup>Some verbs have multiple nominalising strategies. The verb *kfər* 'blaspheme' is one such example, either undergoing metathesis, as shown in (2), or suffixation, as shown here in (3).

<sup>2</sup>The other acceptable nominalisation strategy was suffixation with *-a:n*. There were also two responses in which either metathesis or suffixation with *-a:n* were judged acceptable.

## B Survey of morphological metathesis

Similar judgements were given for the loan words *nmar* (< French *numéroter*) ‘to number’, *mraf* (< French *marcher*) ‘to march’ and *mrəs* (< French *remercier*) ‘to thank’. Among loanwords the only exception was *bləf* < English *bluff*, for which the preferred nominalisation strategy was zero derivation.

The second test Kilani-Schoch & Dressler carried out involved choosing either metathesis or zero derivation as the preferred nominalisation strategy. In this test 17/18 responses selected metathesis.

In summary, metathesis in Tunisian Arabic is one of several processes available to nominalise verbs with the structure CCVC. Metathesis is productive and is the preferred nominalisation strategy. That metathesis in Tunisian Arabic is associated with other processes is consistent with the data in Chapter 2 in which metathesis is associated with a large number of additional processes.

### B.3 Svan

Svan is a Kartvelian language of northern Georgia. Causatives of intransitive verbs are formed in Svan by final VC → CV metathesis. Published sources are extremely scarce. Mel’čuk (1997: 297) gives the six examples in (6) below. In all six instances metathesis derives a causative from an intransitive verb.<sup>3</sup>

(6) Svan causative metathesis (Mel’čuk 1997: 297)

|                  | INTR                       |   | CAUS                       |                 |
|------------------|----------------------------|---|----------------------------|-----------------|
| ‘go out’         | <i>li-deg</i>              | → | <i>li-dge</i>              | ‘extinguish’    |
| ‘break (intr.)’  | <i>li-k<sup>w</sup>es’</i> | → | <i>li-k<sup>w</sup>s’e</i> | ‘break (tr.)’   |
| ‘rot’            | <i>li-k<sup>w</sup>er</i>  | → | <i>li-k<sup>w</sup>re</i>  | ‘make/let rot’  |
| ‘come’           | <i>li-qed</i>              | → | <i>li-qde</i>              | ‘bring, convey’ |
| ‘return (intr.)’ | <i>li-t’ex</i>             | → | <i>li-t’xe</i>             | ‘return (tr.)’  |
| ‘get dirty’      | <i>li-geb</i>              | → | <i>li-gbe</i>              | ‘make dirty’    |

### B.4 Mutsun Ohlone (Costanoan)

Metathesis in the Mutsun variety of Southern Ohlone (a.k.a. Costanoan), a now extinct language of central California (see Figure B.1), is described in Okrand

<sup>3</sup>All six examples in (6) are cited with the prefix *li-* of which Mel’čuk (1997), states “Les exemples ci-dessous sont cités à la forme du nom d’action verbal, appelé *masdar*, dont les rôles syntaxiques sont comparables à ceux de l’infinitif du français.”; “The examples below are given in the form of a verbal action noun, called *masdar*, whose syntactic roles are similar to those of the French infinitive.”

(1979). The same author also wrote a grammar of the language published as Okrand (1977). In both instances data was drawn from material gathered in the early twentieth century from the last fluent speaker.

Verbs in Mutsun have two stems, called the primary stem and the derived stem. The main difference between each stem is that the derived stem is consonant final, while the primary stem can be either vowel final or consonant final. Okrand (1979) identifies seven types of stems of which stem types II, IV, and VII show metathesis. These three stem types are given in Table B.1 (the fourth stem type is poorly attested in the data). In all cases the derived stem is formed from the primary stem by metathesis of the final VC sequence.

Table B.1: Mutsun primary and derived verb stems (Okrand 1979: 125)

|     | Primary                           | Derived                          | Examples                     | Gloss             |
|-----|-----------------------------------|----------------------------------|------------------------------|-------------------|
| II  | CVCV <sub>2</sub> :C <sub>3</sub> | CVCC <sub>3</sub> V <sub>2</sub> | <i>pasi:k-</i> <i>paski-</i> | ‘to greet, visit’ |
| IV  | CV:CV <sub>2</sub> C <sub>3</sub> | CVCC <sub>3</sub> V <sub>2</sub> | <i>li:wak-</i>               | ‘to hide nearby’  |
| VII | CVC:V <sub>2</sub> C <sub>3</sub> | CVCC <sub>3</sub> V <sub>2</sub> | <i>lif:ej-</i> <i>lifje-</i> | ‘to stand’        |

In most cases the use of each stem is either phonologically or morphemically conditioned. A phonologically conditioned use is found before suffixes which begin with a consonant cluster in which case VC → CV metathesis occurs to prevent a cluster of three consonants surfacing. Examples include *pasi:k* ‘visit’ + *-jni* ‘to come to’ → *paskijni* ‘come to visit’ and *lif:ej* ‘to stand’ + *-hte* PERFECTIVE → *lifjehte* ‘already assumed a standing position’.

Likewise, word-final consonant clusters are disallowed in Mutsun. As a result derived stems are used before suffixes consisting of a single consonant. One example is *sot:er* ‘stick out’ + *-j* IMPERATIVE → *sotrej* ‘stick out [your foot]!’ (Okrand 1979: 125).

However, there are also some CV(C) suffixes which only occur with primary stems and other CV(C) suffixes which only occur with derived stems. This is a case of morphemically conditioned metathesis (§2.2.2), in which metathesis is a partial exponent of the morphological category signalled by the suffix.

Suffixes which take primary stems include the reciprocal suffix *-mu* and the reflexive suffix *-pu*, as seen in *hi:wo* ‘scold (s.o.)’ + *-mu* RECP → *hi:womu* ‘(they) quarrel’ and *mat:al* ‘face down’ + *-pu* REFL → *mat:alpu* ‘put oneself face down’. One suffix which takes the derived stem and thus triggers metathesis is *-nu* ‘positional causative’, as seen in *mat:al* ‘face down’ + *-nu* → *matlanu* ‘put (s.o.) face down (into a prone position)’ (Okrand 1979: 126).

## B Survey of morphological metathesis

The morphological function of metathesis comes about because the derived stem is used in isolation as a non-past tense and there are a number of cognate nouns which take the primary stem. Examples are given in (7) below.

(7) Mutsun derivational metathesis (Okrand 1979: 127)

|                 | Noun          | Verb         |                         |
|-----------------|---------------|--------------|-------------------------|
| 'a cough'       | <i>to:her</i> | <i>tohre</i> | 'to cough'              |
| 'flute'         | <i>lul:up</i> | <i>lulpu</i> | 'to play the flute'     |
| 'goose'         | <i>la:lak</i> | <i>lalka</i> | 'gather geese'          |
| 'nest'          | <i>he:sen</i> | <i>hesne</i> | 'make a nest'           |
| 'pozole (stew)' | <i>posol</i>  | <i>poslo</i> | 'to make pozole (stew)' |

Given that Mutsun is now extinct, it is hard to tell exactly how productive metathesis was. However, the occurrence of the Spanish loanword *posol* 'pozole (stew)' with both metathesised and unmetathesised forms indicates that metathesis was productive. It is likely that VC → CV metathesis in Mutsun was used to derive verbs from nouns.<sup>4</sup>

### B.5 Sierra Miwok

Sierra Miwok is a language of central California (see Figure B.1) related to Ohlone (§B.4). My summary of Sierra Miwok metathesis is based on the description in Freeland (1951). Like Ohlone, each verb in Sierra Miwok has multiple stems. There are three derived stems in Sierra Miwok formed from one of four different shapes of the primary (underlying) stem. These different shapes are summarised in Table B.2. on the next page.

The shape of each derived stem is consistent across all four verb classes, with the exception of the second stem of class IV verbs. The second derived stem has the shape CVCVC:, the third stem CVC:VC, and the fourth stem CVCCV.

In all cases the final C-slot is filled by a glottal stop when the root has only two consonants. Similarly, when the root has only a single vowel the final V-slot is filled by /u/ after back rounded vowels, and by /i/ after all other vowels. Both these facts can be seen with the primary stem *lu:f-* 'to win' with the CVC:VC third stem *lu:f:uʔ-* with the final vowel and consonant occurring to fill the otherwise empty V-slot and C-slot.

<sup>4</sup>Mutsun *posol* is a loan from Spanish *pozole*, itself a loan from Nahuatl *pozolli*. The final /e/ of the Spanish form has been re-analysed in Mutsun as the object case suffix; *posol:l-e* (Okrand 1977: 127, fn.14).

Table B.2: Sierra miwok verb stems<sup>†</sup> (Freeland 1951: 94f)

|     | Primary                  | Second                    | Third                     | Fourth                  |           |
|-----|--------------------------|---------------------------|---------------------------|-------------------------|-----------|
| I   | CVCV:C<br><i>tuja:ŋ-</i> | CVCVC:<br><i>tujaŋ:-</i>  | CVC:VC<br><i>tuj:aŋ-</i>  | CVCCV<br><i>tujŋa-</i>  | ‘to jump’ |
| II  | CVCCV<br><i>wikt̥i-</i>  | CVCVC:<br><i>wikt̥i:-</i> | CVC:VC<br><i>wik:iṭ-</i>  | CVCCV<br><i>wikt̥i-</i> | ‘to burn’ |
| III | CVC:V<br><i>ham:e</i>    | CVCV?:<br><i>hame?:-</i>  | CVC:V?<br><i>ham:eʔ-</i>  | CVC?V<br><i>ham?e-</i>  | ‘to bury’ |
| IV  | CV:C<br><i>lu:f-</i>     | CVC:<br><i>lu:f-</i>      | CVC:V?<br><i>lu:f:uʔ-</i> | CVC?V<br><i>luʔu-</i>   | ‘to win’  |

<sup>†</sup> Stress in Sierra Miwok falls on the first heavy syllable; either VCC, V:C, or VC: (Freeland 1951: 7). Because it is predictable, I do not indicate its presence in this section.

Final consonant-vowel metathesis is found in three cases; between the primary stem of verb class I and the fourth stem, with VC → CV metathesis, and between the primary stem of verb class II and the second and third derived stems, with CV → VC metathesis. It is also possible to analyse the epenthetic glottal stop as undergoing metathesis in the third and fourth stems of class III verbs and class IV verbs.

As in Mutsun, some cases of metathesis in Sierra Miwok are instances of phonologically conditioned metathesis. Before a CC-initial suffix the fourth stem is used, thereby avoiding a cluster of three consonants. One example is the class I stem *pola:ŋ* ‘to stagger’ + *-jni* DESIDERATIVE → *polŋajni* (Freeland 1951: 116).

There are also many instances of morphemically conditioned metathesis with different suffixes of the same phonological shape occurring with different stems. Such instances are extremely numerous and I do not provide examples here.

In addition there are also instances in which metathesis alone serves a morphological function. For instance, one nominalisation strategy for class I verbs is to use the fourth stem. Examples are given in (8) below, in which nouns are cited with the SUBJECTIVE suffix *-ʔ*.

- (8) Sierra Miwok verbalising metathesis (Freeland 1951: 149)

|             | Verb           |   | Noun           |                            |
|-------------|----------------|---|----------------|----------------------------|
| 'to relate' | <i>ʔuʔe:n-</i> | → | <i>ʔuʔne-ʔ</i> | 'myth, tale'               |
| 'to tell'   | <i>koyo:w-</i> | → | <i>koywo-ʔ</i> | 'words, speech'            |
| 'to run'    | <i>hiwa:t-</i> | → | <i>hiwʔa-ʔ</i> | 'race'                     |
| 'to play'   | <i>ʔawi:n-</i> | → | <i>ʔawni-ʔ</i> | 'game'                     |
| 'to live'   | <i>ʔuf:u-</i>  | → | <i>ʔufʔu-ʔ</i> | 'health, well-being: year' |
| 'to come'   | <i>ʔin:i-</i>  | → | <i>ʔinʔi-ʔ</i> | 'way, journey'             |
| 'to eat'    | <i>ʔiw:i-</i>  | → | <i>ʔiwʔi-ʔ</i> | 'food'                     |

The processes in Mutsun Ohlone and Sierra Miwok have much in common, as might be expected from related languages. However, in Mutsun Ohlone VC → CV metathesis is a verbaliser while in Sierra Miwok the same process is a nominaliser.

## B.6 Alsea

Alsea is a now extinct language of the Oregon coast (see Figure B.1). The only consonants which participate in metathesis in Alsea are sonorants. Metathesis in Alsea is mostly morphemically conditioned (§2.2.2). One suffix which triggers metathesis is the third person object imperative suffix *-t*. Examples are given in (9) below in which the metathesised stems on the right can be compared with unmetathesised counterparts on the left.

- (9) Alsea morphemically conditioned metathesis (Buckley 2007: 8f)

|                       |                            |                            |                            |
|-----------------------|----------------------------|----------------------------|----------------------------|
| 'had closed it'       | <i>tmús-sa-nχ</i>          | <i>túms-t</i>              | 'close it!'                |
| 'agreed to it'        | <i>t'más-sal-tχ</i>        | <i>t'áms-t</i>             | 'finish it!'               |
| 'had been sliding'    | <i>stlák-sal-tχ</i>        | <i>stálk-t</i>             | 'slide it!'                |
| 'is packing'          | <i>tsuláq'n-tχ</i>         | <i>tsuálg'n-t</i>          | 'pack it!'                 |
| 'is close to shore'   | <i>tlúq<sup>w?</sup>-χ</i> | <i>túlq<sup>w?</sup>-t</i> | 'bring it close to shore!' |
| 'is in act of hiding' | <i>pyáχ-aw-tχ</i>          | <i>páyX-t</i>              | 'hide it!'                 |
| 'had pierced'         | <i>qʔjút-sal</i>           | <i>qʔúj-t</i>              | 'prick him!'               |

That this metathesis is not conditioned by the phonological shape of the suffix is shown by the contrast between suffixes with an identical form, one of which triggers metathesis while the other does not. The intransitive imperative suffix *-χ* triggers metathesis while the completive realis *-χ* suffix does not trigger metathesis. Examples are given in (10) below.

- (10) Alsea morphemically conditioned metathesis (Buckley 2007: 8f)

|                    | CMPL.RL         | INTR.IMP        |                    |
|--------------------|-----------------|-----------------|--------------------|
| ‘dances with them’ | <i>knáχ-χ</i>   | <i>kánχ-χ</i>   | ‘dance with them!’ |
| ‘are lying in bed’ | <i>tsnúš-χ</i>  | <i>tsúns-χ</i>  | ‘lie down!’        |
| ‘is hiding’        | <i>pjáχ-χ</i>   | <i>pájχ-χ</i>   | ‘hide!’            |
| ‘is floating’      | <i>tspjút-χ</i> | <i>tspújt-χ</i> | ‘float!’           |

In addition to such morphemically conditioned metathesis there are also hints that Alsea had a process of morphological metathesis which signalled aspect. Buckley (2007) gives three potential examples, given in (11) below.

- (11) Alsea morphological metathesis (Buckley 2007: 10)

|                          |                                            |                                            |                          |
|--------------------------|--------------------------------------------|--------------------------------------------|--------------------------|
| ‘keep it shut!’          | <i>tmús-t</i>                              | <i>túms-t</i>                              | ‘shut it!’               |
| ‘is stretched out’       | <i>tsłjáq-tχ</i>                           | <i>tsłájq-tχ</i>                           | ‘made it straight’       |
| ‘was (not)<br>overtaken’ | <i>tsq<sup>w</sup>náq<sup>w</sup>-tn-χ</i> | <i>tsq<sup>w</sup>ánq<sup>w</sup>-tn-χ</i> | ‘was being<br>overtaken’ |

However, such examples come only from elicitation with no indication of the context in which they could be used. Nonetheless, given the (historic) location of Alsea, bordering on the area in which Salishan languages are spoken (see Figure B.1), it would not be surprising if Alsea had also developed a morphological process of morphological metathesis to mark aspect.<sup>5</sup>

## B.7 Salishan

The Salishan languages are a family of languages spoken in the Pacific Northwest, around the western border of the United States of America and Canada (see Figure B.1). Most Salishan languages are either critically endangered or have recently become extinct. I discuss metathesis in three Salishan varieties, all of which belong to the Coast Salish group. These varieties include two varieties of Straits Salish: Saanich (§B.7.1) and Klallam (§B.7.2), as well as a Central Salishan variety, Halkomelem (§B.7.3). All are spoken in the immediate vicinity of Southern Vancouver island.

In each of these Salishan varieties metathesis signals the so-called actual aspect described by Thompson & Thompson (1969: 215) as an “action or state in effect at a particular moment”. Thompson & Thompson compare this actual aspect to

<sup>5</sup>Alsea is not considered genealogically related to the Salishan languages.

## B Survey of morphological metathesis

the Slavic imperfective as well as the English *be ...-ing* progressive. I refer to this aspect as the imperfective (IPFV) throughout this section.

In each Salishan language metathesis is only one of a number of processes used to form the imperfective. Other processes include reduplication, infixation, glottalisation, apocope, and apophony (among others). Which process applies can usually, though not always, be predicted based on the phonological shape of the perfective stem.

### B.7.1 Saanich

I begin my discussion of Salishan metathesis with Saanich, a variety of Straits Salish. Saanich metathesis is described in Montler (1986; 1989). Several different processes operate in Saanich to form the imperfective aspect. These processes include infixation, reduplication, and metathesis. Which of these processes operates is determined by the shape of the stem, with the goal being to achieve a CVCC word structure for the imperfective. In addition to these processes all non-initial sonorants are glottalised in imperfective forms.

Metathesis occurs in two environments. Firstly, when the root contains no vowels and is suffixed with a vowel-initial suffix, metathesis of this vowel and the root final consonant occurs to form the imperfective. Examples are given in (12) below, with the ‘control transitive’ suffix *-ət*.

(12) Saanich  $C_1C_2-V_1... \rightarrow C_1V_1C_2...$  (Montler 1989: 97)

| Root                |              | PFV             |               | IPFV            |                 |
|---------------------|--------------|-----------------|---------------|-----------------|-----------------|
| $\sqrt{q'p'}$       | ‘patch it’   | $x^w-q'p'-ət$   | $\rightarrow$ | $x^w-q'əp't$    | ‘patching it’   |
| $\sqrt{sq'}$        | ‘tear it’    | $sq'-ət$        | $\rightarrow$ | $səq't$         | ‘tearing it’    |
| $\sqrt{s\chi}$      | ‘push it’    | $s\chi-ət$      | $\rightarrow$ | $sə\chi t$      | ‘pushing it’    |
| $\sqrt{fj'}$        | ‘whip it’    | $fj'-ət$        | $\rightarrow$ | $fəj't$         | ‘whipping it’   |
| $\sqrt{tk^w}$       | ‘break it’   | $tk^w-ət$       | $\rightarrow$ | $tək^wt$        | ‘breaking it’   |
| $\sqrt{tq^w}$       | ‘tighten it’ | $tq^w-ət$       | $\rightarrow$ | $təq^wt$        | ‘tightening it’ |
| $\sqrt{t's}$        | ‘break it’   | $t's-ət$        | $\rightarrow$ | $t'əst$         | ‘breaking it’   |
| $\sqrt{\theta\chi}$ | ‘shove it’   | $\theta\chi-ət$ | $\rightarrow$ | $\thetaə\chi t$ | ‘shoving it’    |

Similarly CCəC roots form the imperfective by metathesis of the second consonant with the following vowel. Examples are given in (13) below. Only stems containing the vowel [ə] undergo metathesis in Saanich.



- (13) Saanich
- $C_1C_2\text{ə}C_3 \rightarrow C_1\text{ə}C_2C_3$
- (Montler 1986; 1989: 93,97)

| Root                                           | PFV                       | IPFV                                          |
|------------------------------------------------|---------------------------|-----------------------------------------------|
| $\sqrt{t^\theta}t\acute{a}k^w$ ‘pinch’         | $t^\theta t\acute{a}k^w$  | $t^\theta \acute{a}k^w$ ‘pinching’            |
| $\sqrt{t^l}p\acute{\alpha}\chi$ ‘scatter’      | $t^l p\acute{\alpha}\chi$ | $t^l \acute{\alpha}p\chi$ ‘scattering’        |
| $\sqrt{t^l}k^w\acute{\alpha}t$ ‘extinguish it’ | $t^l k^w\acute{\alpha}t$  | $t^l \acute{\alpha}k^w t$ ‘extinguishing it’  |
| $\sqrt{\theta}t\acute{a}q^w$ ‘pierce it’       | $\theta t\acute{a}q^w$    | $\theta \acute{a}t\acute{a}q^w$ ‘piercing it’ |

With stems of other shapes, reduplication or infixation of /ʔ/ occurs. The process of reduplication copies the first consonant of a CVC root and places it after the first vowel. Reduplication applies “[...] when stress is on the root and the root either 1) stands alone as a stem by itself or 2) is followed by a suffix beginning with a consonant.” (Montler 1989: 95). Examples are given in (14) below. Predictable schwas are transcribed with a breve [ə].

- (14) Saanich
- $C_1\acute{V}C_2 \rightarrow C_1\acute{V}C_1C_2$
- (Montler 1989: 95)

| Root                                    | PFV                   | IPFV                                                       |
|-----------------------------------------|-----------------------|------------------------------------------------------------|
| $\sqrt{qen}$ ‘it’s stolen’              | $sqén$                | $qéq\acute{a}n$ ‘he’s stealing’                            |
| $\sqrt{t^\theta}e\acute{?}$ ‘be on top’ | $t^\theta \acute{e}?$ | $t^\theta \acute{e}t^\theta \acute{ə}?$ ‘riding (a horse)’ |
| $\sqrt{q^w}a\acute{l}$ ‘say’            | $q^w a\acute{l}$      | $q^w \acute{a}q^w a\acute{l}$ ‘saying (sth.)’              |
| $\sqrt{k^w}ul$ ‘school’                 | $s-k^w \acute{u}l$    | $s-k^w \acute{u}k^w a\acute{l}$ ‘going to school’          |
| $\sqrt{tik^w}$ ‘trip’                   | $tik^w-s\acute{a}n$   | $tít\acute{a}k^w-s\acute{a}n$ ‘tripping’                   |

In other cases a glottal stop is infixated after the first vowel. This infixation can also be accompanied by other various phonological processes such as apophony. Examples of infixation which do not involve any additional complications are given in (15) below.

- (15) Saanich
- $C_1VC_2(VC) \rightarrow C_1V\acute{?}C_2(VC)$
- (Montler 1989: 98)

| Root                                | PFV                                 | IPFV                                                             |
|-------------------------------------|-------------------------------------|------------------------------------------------------------------|
| $\sqrt{?etf}$ ‘wipe it’             | $?étf-\acute{\alpha}t$              | $?é\langle ? \rangle tf-\acute{\alpha}t$ ‘wiping it’             |
| $\sqrt{?it\acute{a}n}$ ‘eat’        | $?it\acute{a}n$                     | $?i\langle ? \rangle t\acute{a}n$ ‘eating’                       |
| $\sqrt{?faq^w}$ ‘sweat’             | $?f\acute{a}q^w-\acute{\alpha}\eta$ | $?f\acute{a}\langle ? \rangle q^w-\acute{\alpha}\eta$ ‘sweating’ |
| $\sqrt{?weq\acute{\alpha}s}$ ‘yawn’ | $wéq\acute{\alpha}s$                | $wé\langle ? \rangle q\acute{\alpha}s$ ‘yawning’                 |
| $\sqrt{x^wit}$ ‘jump’               | $x^w\acute{i}t-\acute{\alpha}\eta$  | $x^w\acute{i}\langle ? \rangle t-\acute{\alpha}\eta$ ‘jumping’   |
| $\sqrt{?am\acute{\alpha}t}$ ‘sleep’ | $?ám\acute{\alpha}t$                | $?á\langle ? \rangle m\acute{\alpha}t$ ‘sleeping’                |

In Saanich metathesis is one of several processes which occurs to form the imperfective. Other processes include reduplication and infixation. Which process operates is determined by the phonological shape of the stem, with the goal of forming a CVCC word shape in the imperfective.

## B Survey of morphological metathesis

It may be possible at an abstract level to analyse surface metathesis in Saanich as an artefact of other phonological processes. This is particularly so given that Saanich metathesis only affects roots with schwa /ə/. This is the approach taken by Demers (1974) for similar data in the closely related language Lummi (discussed in §2.4.2.1), in which metathesis is analysed as resulting from stress shift with subsequent deletion of unstressed vowels.

### B.7.2 Klallam

Klallam is very closely related to Saanich and the data on Klallam metathesis is similar to that in Saanich. Metathesis in Klallam is described by Thompson & Thompson (1969). As in Saanich, there are a number of process for forming the imperfective aspect in Klallam. These processes include infixation of /ʔ/, metathesis, and reduplication.

Examples of verbs which form the imperfective by metathesis are given in (16) below. All words are cited with the control suffix *-t*. Predictable schwas are transcribed with a breve [ə].

(16) Klallam CCV → CVC (Thompson & Thompson 1969: 216)

|                | PFV                                  |   | IPFV                                 |                    |
|----------------|--------------------------------------|---|--------------------------------------|--------------------|
| 'tie up'       | <i>q'x<sup>w</sup>i-t</i>            | → | <i>q'ix<sup>w</sup>-t</i>            | 'tying up'         |
| 'scratch'      | <i>χʃ<sup>w</sup>i-t</i>             | → | <i>χiʃ<sup>w</sup>-t</i>             | 'scratching'       |
| 'restrain'     | <i>qq'i-t</i>                        | → | <i>qiq'-t</i>                        | 'restraining'      |
| 'shoot'        | <i>ʃk<sup>w</sup>ú-t</i>             | → | <i>ʃúk<sup>w</sup>-t</i>             | 'shooting'         |
| 'throw'        | <i>ʃʃú-t</i>                         | → | <i>ʃús-t</i>                         | 'throwing'         |
| 'shatter'      | <i>t'tsə-t</i>                       | → | <i>t'əts-t</i>                       | 'shattering'       |
| 'grasp'        | <i>t<sup>h</sup>k<sup>w</sup>ə-t</i> | → | <i>t<sup>h</sup>ək<sup>w</sup>-t</i> | 'grasping'         |
| 'swallow'      | <i>ŋəq'ə-t</i>                       | → | <i>ŋəq'<sup>h</sup>-t</i>            | 'swallowing'       |
| 'pick up'      | <i>mək<sup>w</sup>ə-t</i>            | → | <i>mək<sup>w</sup>'-t</i>            | 'picking up'       |
| 'burn'         | <i>ʃq<sup>w</sup>ə-t</i>             | → | <i>ʃəq<sup>w</sup>-t</i>             | 'burning'          |
| 'tear'         | <i>ʃχə-t</i>                         | → | <i>ʃəχ-t</i>                         | 'tearing'          |
| 'chop'         | <i>q'm<sup>h</sup>ə-t</i>            | → | <i>q'əm<sup>h</sup>-t</i>            | 'chopping'         |
| 'bite'         | <i>ts'əŋ<sup>h</sup>ə-t</i>          | → | <i>ts'əŋ<sup>h</sup>'-t</i>          | 'biting'           |
| 'put in water' | <i>mətəq<sup>w</sup>-t</i>           | → | <i>mətq<sup>w</sup>-t</i>            | 'putting in water' |
| 'pour'         | <i>k<sup>w</sup>j<sup>h</sup>ə-t</i> | → | <i>k<sup>w</sup>əj<sup>h</sup>-t</i> | 'pouring'          |

Other verbs form the imperfective by infixation of the glottal stop after the first vowel. Some examples are given in (17) below.

- (17) Klallam
- $C_1VC_2(VC) \rightarrow C_1V\langle ? \rangle C_2(VC)$
- (Thompson & Thompson 1969: 216)

|            | PFV                        |   | IPFV                          |                |
|------------|----------------------------|---|-------------------------------|----------------|
| ‘wipe’     | <i>ʔáʔf<sup>o</sup>-t</i>  | → | <i>ʔá⟨ʔ⟩ʔf<sup>o</sup>-t</i>  | ‘wiping’       |
| ‘nudge’    | <i>ts’út<sup>o</sup>-t</i> | → | <i>ts’ú⟨ʔ⟩t<sup>o</sup>-t</i> | ‘nudging’      |
| ‘make’     | <i>ʔáʔf<sup>o</sup>-t</i>  | → | <i>ʔá⟨ʔ⟩ʔf<sup>o</sup>-t</i>  | ‘making’       |
| ‘blow’     | <i>púx<sup>w</sup>-t</i>   | → | <i>pú⟨ʔ⟩x<sup>w</sup>-t</i>   | ‘blowing’      |
| ‘set fire’ | <i>húnǎ-t</i>              | → | <i>hú⟨ʔ⟩nǎ-t</i>              | ‘setting fire’ |

Metathesis and glottal stop infixation are the two most common ways of forming the imperfective in Klallam. Another strategy is reduplication, as seen in *jáʔ-t* → *jáʔǎʔ-t* ‘prepare’. (Reduplication also involves a change in the quality of the root vowel.)

There are also verbs which combine glottal stop infixation with either reduplication or metathesis. When metathesis and infixation are combined, the glottal stop infix ends up after the first consonant. Examples are given in (18).

- (18) Klallam
- $C_1VC_2 \rightarrow C_1\langle ? \rangle C_2V$
- Thompson & Thompson (1969: 216)

|           | PFV                                    |   | IPFV                                      |              |
|-----------|----------------------------------------|---|-------------------------------------------|--------------|
| ‘beat’    | <i>q<sup>w</sup>’úʔf<sup>o</sup>-t</i> | → | <i>q<sup>w</sup>’ǎ⟨ʔ⟩ʔú<sup>o</sup>-t</i> | ‘beating’    |
| ‘inflate’ | <i>sújǎ-t</i>                          | → | <i>sǎ⟨ʔ⟩jú<sup>o</sup>-t</i>              | ‘inflating’  |
| ‘command’ | <i>sá-t</i>                            | → | <i>sǎ⟨ʔ⟩á-t</i>                           | ‘commanding’ |

In Klallam metathesis is one of at least three strategies used to form the imperfective. The fact that a variety of roots – not only those with medial schwa – undergo metathesis to form the imperfective poses a challenge for analyses of the Klallam data in which metathesis is viewed as an artefact of other processes, such as epenthesis and vowel deletion, as discussed by Blevins & Garrett (1998: 540). Regarding such an analysis, Thompson & Thompson (1969: 217) state:

This treatment [an analysis involving true metathesis] has the advantage of not requiring the setting up of special hypothetical base forms like \*čuk<sup>w</sup>ut [\*ʔuk<sup>w</sup>ut ‘shoot’], with actual and non-actual forms derived by vowel deletion, or positing special stress patterns inserting vowels in different positions with relation to root consonants. The current popular tendency to resort to such abstractions (even where they may be well motivated in historical-comparative terms) is at variance with objective consideration of the facts of particular language structures and tends to obstruct our efforts to understand how languages change and to obscure phenomena important in the consideration of typological similarities.

### B.7.3 Halkomelem

My summary of metathesis in Halkomelem is based on that provided by Urbanczyk (2011), who describes the Hul'q'umi'num' (Vancouver Island) dialect. As in the other Salishan languages discussed, metathesis in Halkomelem is one of several processes used to form the imperfective. Other processes include vowel apophony, reduplication, and vowel deletion. Which process applies is (mostly) determined by the phonological shape of the verb.

Metathesis occurs when the verb root contains two obstruents followed by a vowel. Examples are given in (19) below. As in Saanich, non-initial sonorants are additionally glottalised in the imperfective.

- (19) Halkomelem  $C_1C_2V \rightarrow C_1VC_2$  (Hukari (1978) in Urbanczyk 2011: 477f)

|                 | PFV                                  |   | IPFV                                 |                        |
|-----------------|--------------------------------------|---|--------------------------------------|------------------------|
| 'break it'      | <i>pq<sup>w</sup>á-t</i>             | → | <i>páq<sup>w</sup>-t</i>             | 'breaking it'          |
| 'break it'      | <i>t'q<sup>w</sup>á-t</i>            | → | <i>t'áq<sup>w</sup>-t</i>            | 'breaking it'          |
| 'pull it'       | <i>x<sup>w</sup>k<sup>w</sup>á-t</i> | → | <i>x<sup>w</sup>ák<sup>w</sup>-t</i> | 'pulling it'           |
| 'tear/split it' | <i>sq'é-t</i>                        | → | <i>séq'-t</i>                        | 'tearing/splitting it' |

Urbanczyk (2011) compares metathesis to a process of stress shift and schwa insertion, viewing metathesis as a specific instances of this latter process. Examples of imperfectives formed by stress shift and epenthesis are given in (20).

- (20) Halkomelem  $C_1C_2V \rightarrow C_1\acute{C}_2\text{ə}$  (Urbanczyk 2011: 478)

|                                | PFV                         |   | IPFV                          |                                  |
|--------------------------------|-----------------------------|---|-------------------------------|----------------------------------|
| 'tell him/her'                 | <i>tse-t</i>                | → | <i>tśásə-t</i>                | 'telling him/her'                |
| 'put it near'                  | <i>tse-t</i>                | → | <i>tśəsə-t</i>                | 'putting it near'                |
| 'count stitches'               | <i>k<sup>w</sup>fálas-t</i> | → | <i>k<sup>w</sup>ǰfəl'əs-t</i> | 'counting stitches'              |
| 'slice out a piece of weaving' | <i>łts'álas-t</i>           | → | <i>łts'əl'əs-t</i>            | 'slicing out a piece of weaving' |

When the verb begins with CVC where neither consonant is a laryngeal, or if the verb begins with an obstruent followed by schwa, the first CV is reduplicated as a prefix to form the perfective. If the vowel of the reduplicant is not schwa, stress falls on this vowel and other vowels are reduced to schwa. If the vowel of the reduplicant is schwa, stress falls on the second vowel.

- (21) Halkomelem
- $C_1V_1C_2 \rightarrow C_1V_1C_1\text{ə}C_2$
- (Urbanczyk 2011: 474f)

|                  | PFV                       |   | IPFV                                     |                 |
|------------------|---------------------------|---|------------------------------------------|-----------------|
| ‘cut it’         | <i>ʔits’ət</i>            | → | <i>ʔiʔats’ət</i>                         | ‘cutting it’    |
| ‘fight’          | <i>k<sup>w</sup>intəl</i> | → | <i>k<sup>w</sup>ik<sup>w</sup>ən’təl</i> | ‘fighting’      |
| ‘topple down’    | <i>jeq’</i>               | → | <i>jéj’əq’</i>                           | ‘toppling down’ |
| ‘get near’       | <i>təs</i>                | → | <i>tətás</i>                             | ‘getting near’  |
| ‘break’          | <i>t’əq<sup>w</sup></i>   | → | <i>t’ət’əq<sup>w</sup></i>               | ‘breaking’      |
| ‘stretched taut’ | <i>θək<sup>w</sup></i>    | → | <i>θəθək<sup>w</sup></i>                 | ‘stretching’    |

When the root begins with a sonorant (L) followed by schwa, the imperfective is reported to be formed by CV reduplication with subsequent reduction of the initial sonorant to /h/. Stress falls on the reduplicant and the following schwa is deleted, resulting in surface metathesis when comparing the perfective and imperfective forms. Examples are given in (22) below.

- (22)
- $L_1\text{ə}C_2 \rightarrow h\acute{s}L_1C_2$
- (Hukari & Peter (1995) in Urbanczyk 2011: 475)

|                    | PFV                                |   | IPFV                                 |                       |
|--------------------|------------------------------------|---|--------------------------------------|-----------------------|
| ‘fill it’          | <i>l\acute{a}ts’ət</i>             | → | <i>h\acute{a}l’ts’t</i>              | ‘filling it’          |
| ‘pile hay’         | <i>m\acute{a}k<sup>w</sup>els</i>  | → | <i>h\acute{a}m’k<sup>w</sup>əl’s</i> | ‘piling hay’          |
| ‘bounce a cradle’  | <i>n\acute{a}k<sup>w</sup>əjəl</i> | → | <i>h\acute{a}n’k<sup>w</sup>əjəl</i> | ‘bouncing a cradle’   |
| ‘drift downstream’ | <i>w\acute{a}q<sup>w</sup>ətəm</i> | → | <i>h\acute{a}w’q<sup>w</sup>ətəm</i> | ‘drifting downstream’ |

The remaining two ways of forming the imperfective are apophony and schwa deletion. Both are found with tri-consonantal roots, the latter only when the suffix is *-m*. Examples are given in (23) below.

- (23) Halkomelem apophony/schwa deletion (Urbanczyk 2011: 475f)

|                 | PFV                           |   | IPFV                         |                    |
|-----------------|-------------------------------|---|------------------------------|--------------------|
| ‘slurp it’      | <i>ʔəp’t<sup>θ</sup>-t</i>    | → | <i>ʔep’t<sup>θ</sup>-t</i>   | ‘slurping it’      |
| ‘seek’          | <i>səwq’</i>                  | → | <i>sew’q’</i>                | ‘seeking’          |
| ‘fall apart’    | <i>ts’át’əq<sup>w</sup>əm</i> | → | <i>ts’át’q<sup>w</sup>əm</i> | ‘falling apart’    |
| ‘fall (leaves)’ | <i>tʔ’épəχəm</i>              | → | <i>tʔ’épχəm</i>              | ‘falling (leaves)’ |

In Halkomelem metathesis is one of several processes used to form the imperfective. Other processes include stress shift, reduplication, apophony, and apocope. Which process applies is predictable based on the phonological shape of the root. Metathesis affects roots which contain two obstruents.



# Appendix C: Selected Amarasi texts

## C.1 Preface

In this appendix I present four Amarasi texts, three from the Kotos dialect, which is the focus of this book, and one from Ro'is. The Kotos texts include a narrative about a recent event (§C.2), a myth about the beginning of the world (§C.3), and a conversation (§C.4). The Ro'is text (§C.5) is a short life history.

Each sentence/intonation unit is given twice. The first line is sequentially numbered and gives an orthographic transcription. The second line is numbered according to its time in the recording. This line is given in phonemic transcription, which is followed by the gloss and a free translation.

Glossing follows the same conventions used throughout this book, with the exception that the third person singular genitive suffix *-n* is glossed 3GEN in the Kotos texts and 3PSR;SG.PSM in the Ro'is text (§A.3.1.2).

The only instances of metathesis which are indicated in the glosses are those which have a morphological meaning: M-forms of nouns modified by an attributive modifier (Chapter 6) and U-forms of vowel-final verbs and other word classes which take discourse-driven U-forms (Chapter 7). Non-morphological M-forms and U-forms can be detected by comparing the phonemic transcription in the top line with the corresponding underlying forms in the second line.

## C.2 The death of Nahor Bani

### C.2.1 Metadata

|                    |                                                                                                                                                         |
|--------------------|---------------------------------------------------------------------------------------------------------------------------------------------------------|
| File-name:         | aaz20130928_01                                                                                                                                          |
| Archive-link:      | <a href="http://catalog.paradisec.org.au/collections/OE1/items/aaz20130928_01">http://catalog.paradisec.org.au/collections/OE1/items/aaz20130928_01</a> |
| Original Name:     | aaz-20130928-1-HeronimusBani-CeritaNahorBaniMati                                                                                                        |
| Language:          | Amarasi [aaz]                                                                                                                                           |
| Dialect:           | Kotos; Koro'oto hamlet                                                                                                                                  |
| Location:          | Nekmese', Amarasi Selatan, Kupang                                                                                                                       |
| Date:              | 28/09/2013                                                                                                                                              |
| Speaker(s):        | Heronimus Bani                                                                                                                                          |
| Recorded by:       | Heronimus Bani, Owen Edwards                                                                                                                            |
| Transcribed by:    | Heronimus Bani                                                                                                                                          |
| Interlinear by:    | Owen Edwards                                                                                                                                            |
| Indonesian/Kupang: | Heronimus Bani                                                                                                                                          |
| Free English by:   | Charles E. Grimes                                                                                                                                       |
| Genre:             | narrative                                                                                                                                               |
| Summary:           | Roni relates a disagreement over where recently deceased Nahor Bani should be buried                                                                    |

### C.2.2 Notes

Heronimus Bani relates about a disagreement over where recently deceased Nahor Bani should be buried. Most families want to bury their loved ones in their yard so they can care for the grave. The government has been pushing for everyone to be buried in designated community graveyards (Indonesian *T.P.U.* = *tempat pemakaman umum*) “for public health reasons”. Culturally in Timor, the *nitu* ‘spirit of the dead’ can disturb, disrupt, cause sickness, crop failure, etc. to the living if angry or neglected. Monitoring and taking good care of the grave is one way to show respect and prevent bad things happening to good people.<sup>1</sup>

---

<sup>1</sup>Thanks go to Charles Grimes for the cultural background to this text.



C.2.3 The text

- (1) *Neno ia aam Nahor Bani in nmaet.*
- 0.02 *neno ia aam Nahor Bani iin n-maet*  
*neno ia ama Nahor Bani ini n-mate*  
 day 1DEM father\M Nahor Bani 3SG 3-die  
 ‘Today father Nahor Bani died.’
- (2) *Oras in nmate te,*
- 0.06 *oras iin n-mate =te*  
*oras ini n-mate =te*  
 time 3SG 3-die\U =SUB  
 ‘When he died, ’
- (3) *in aan moen jes, kaan ee nai' Fanu,*
- 0.11 *iin aan moonɔ̄=ees, kaan-n=ee nai? Fanu*  
*ini anah mone=esa kana-n=ee nai? Fanu*  
 3SG child\M male=one name-3GEN=3DET Mr. Fanu  
 ‘one of his sons named Fanu’
- (4) *anhain nain nopu.*
- 0.17 *a/n-hain n-ain nopu*  
*n-hani n-ani nopu*  
 3-dig 3-before hole  
 ‘had dug the grave beforehand.’
- (5) *Re' uaba ma too mfaun re' kuan ii naan ii nak am: nopu mnanun.*
- 0.20 a. *re? uaba =m too mfaun*  
*re? uaba =ma too mfaun*  
 REL speech =ma populace many
- b. *re? kuan=ii naan-n=ii n-aka =m eh n-aka =m eh n-aka =m*  
*re? kuan=ii nana-n=ii n-ak =ma nopu mnanu-n*  
 REL village=1DET inside-3GEN=1DET 3-say =and hole deep-3GEN  
 ‘of which it was said, (by) many people who (are) in this village, (they) said the grave was deep.’

C Selected Amarasi texts

(6) *In ka nhain je ruum aah fa te, nhani nrair je te, nrame.*

- 0.30 a. *iin ka= n-haandɔ̄=ee ruum=aah =fa =te*  
*ini ka= n-hani=ee ruum=aha =fa =te*  
 3SG NEG= 3-dig=3SG.ACC plain=just =NEG =SUB  
 ‘He did not just dig it plainly (i.e. with plain dirt walls),’
- b. *n-hani n-raardɔ̄=ee =t n-rame*  
*n-hani n-rari=ee =te n-rame*  
 3-dig 3-finish=3SG.ACC =SUB 3-plaster\U  
 ‘(when) he finished digging it, he plastered it (with concrete).’

(7) *Nraem je reko-reko.*

- 0.33 *n-raamdɔ̄=ee reko~reko*  
*n-rame=ee reko~reko*  
 3-plaster=3SG.ACC FRD~good  
 ‘He plastered it properly.’

(8) *Onaim re' natfeek onai te, are' amahonit, ana'a prenatal, too mfaun ein, neem nabuan am,*

- 0.36 a. *onai =m, re? na-tfeek onai =te are? amahonit, ana?aprenat*  
*onai =ma re? na-tfeka onai =te are? amahonit ana?aprenat*  
 and.so REL 3-cut.off and.then every parent official
- b. *too mfaun=ein, neem na-bua=n =am*  
*too mfaun=eni nema na-bua=n =ma*  
 populace many=PL 3\come 3-gather=PL =and  
 ‘So, when (the breath of the deceased) was cut off (= died) then all the parents/clan elders, (local) government officials, and many of the populace came and gathered’<sup>2</sup>

<sup>2</sup>The form *amahonit* ‘parent’ (with variant *mahonit*) is a lexicalised nominalisation from *a-ma-honi-t* NML-PROP-born-NML. The phrase *ana?aprenat* ‘official’ is a lexicalised historic nominalisation from *a-na?a-t* NML-hold-NML + *prenat* ‘govern’.

(9) *he na'uab ein neu re' he tpafa' ai' tsuba ma, on re' mee?*

0.48 a. *he na-ʔuab=ein n-eu reʔ he a|t-pafaʔ aiʔ t-suba =ma*  
*he na-ʔuaba=eni n-eu reʔ he t-pafaʔ aiʔ t-suba =ma*  
 IRR 3-speak=PL 3-DAT REL IRR 1PI-protect or 1PI-bury\U =and

b. *on reʔ mee*  
*on reʔ mee*  
 like TOP how

‘to discuss about how we are going protect or bury (the body) and how (are we going to go about this)?’

(10) *Oat hau gui on re' mee, ai' noup paarn ii on re' mee?*

0.57 *oat haagw=ii on reʔ mee, aiʔ noup paar-n=ii, on reʔ mee*  
*ote hau=ii on reʔ mee aiʔ noup para-n=ii on reʔ mee*  
 cut\M wood=1DET like TOP how or hole\M short-3GEN=1DET like TOP how

‘How should the cutting of the wood (for the casket) be? Or, how short should the hole (for the grave) be?’

(11) *Ma nupu mnaunʔ ii te, on re' mee?*

1.02 *ma nupu mnaunʔ=ii =t on reʔ mee*  
*ma nupu mnanuʔ=ii =te on reʔ mee*  
 and hole deep=1DET =SUB like TOP how

‘and how deep should the hole be?’

(12) *Onai te, re' nai' Faun gui, fee'n ii uab ii,*

1.06 *onai =te reʔ naiʔ Faanʔgw=ii, feeʔn=ii uab=ii,*  
*onai =te reʔ naiʔ Fanu=ii feʔen=ii uaba=ii*  
 then TOP Mr. Fanu=1DET earlier=1DET speech=1DET

‘So then this Fanu (that I) mentioned earlier,’

C Selected Amarasi texts

(13) *nak on in ka natonan fa ana'a preent ein ii, ai' mahoint ein ii, neu re' in nhain nain nopu.*

1.10 *n-ak on iin ka= na-tona=n =fa ana?apreent=ein=ii ai?*  
*n-ak on ini ka= na-tona=n =fa ana?aprenat=eni=ii ai?*  
 3-say IRR.LOC 3SG NEG= 3-tell=PL =NEG official=PL=1DET or  
*mahoint=ein=ii n-eu re? iin n-hain n-ain nopu*  
*amahonit=eni=ii n-eu re? ini n-hani n-ani nopu*  
 parents=PL=1DET 3-DAT TOP 3SG 3-dig 3-before hole  
 '(it was) said that he had not told the government officials, or the clan leaders that he had dug the grave beforehand.'

(14) *Ai' in nmesel anrari, nrame nrari.*

1.18 *ai? iin n-mesel a|n-rari, n-rame n-rari*  
*ai? ini n-mesel n-rari n-rame n-rari*  
 or 3SG 3-grave.cover 3-finish\U 3-plaster 3-finish\U  
 'or that he had built the grave cover and had plastered it with cement.'

(15) *In nmeerk on.*

1.22 *iin n-meerk=oo-n*  
*ini n-merak=oo-n*  
 3SG 3-quiet=REFL-3GEN  
 'He kept himself quiet.'

(16) *Onaim ana'a preent ein nok nai' Fanu in taatf eni,*

1.22 *onai =m ana?apreent=ein n-ok nai? Fanu iin taat-f=eni*  
*onai =ma ana?aprenat=eni n-oka nai? Fanu ini tata-f=eni*  
 and.so official=PL 3-with Mr. Fanu 3SG eSi-GEN=PL\U  
 'So the government officials and Fanu's elder siblings'

(17) *aam Simson nok aam Ayub, nema ntean onai te,*

1.28 *aam Simson n-ok aam Ayup nema n-tea=n onai =t*  
*ama Simson n-oka ama Ayup nema n-tea=n onai =te*  
 father\M Simson 3-with father\M Ayub 3\come 3-until=PL and.then  
 'Mr. Simson (Samson) and Mr. Ayub (Job) came'

(18) *nak on na'uab ein am ma,*

1.32 *n-ak on na-ʔuab=ein =ama*

*n-ak on na-ʔuaba=eni =ma*

*3-say like 3-speak=PL =and*

‘thinking like they were going to discuss, and’

(19) *sin he nnaon nsuban on bare 'bua' re' nteek ee nak T.P.U.*

1.34 a. *siin he n-nao=n n-suba=n on, bare ʔ-bua-ʔ*

*sini he n-nao=n n-suba=n on bare ʔ-bua-ʔ*

*3PL IRR 3-go=PL 3-bury=PL IRR.LOC place NML-gather-NML*

‘they were going to go bury him at the place (where graves are) gathered’

b. *reʔ n-teek=ee n-ak, tee pee uu*

*reʔ n-teka=ee n-ak tee pee uu*

*REL 3-call=3SG.ACC 3-QUOT T P U*

‘which is called T.P.U. (*tempat pemakaman umum* = public burial place)’

(20) *Hei, maans ee nmaeb ia te,*

1.41 *heeʔ maans=ee n-maeb ia =te*

*heeʔ manas=ee n-mabe ia =te*

*hey sun=3DET 3-afternoon 1DEM =SUB*

‘Well, late this afternoon’

(21) *uab ii nfain suir jeen, nasurin.*

1.43 *uab=ii n-fain suurɕ=een, na-suri=n.*

*uaba=ii n-fani suri=ena na-suri=n*

*speech=1DET 3-turn collide=INCEP 3-collide=PL*

‘the discussion had turned into a clash, they were at cross purposes.’

(22) *Nasurin neu re' aam Fanu in neekn ii he nsuub nabaar re' kintal natuin*

1.47 a. *na-suri=n n-eu reʔ aam Fanu iin neek-n=ii*

*na-suri=n n-eu reʔ ama Fanu ini neka-n=ii*

*3-collide=PL 3-DAT TOP father\M Fanu 3SG feelings-3GEN=1DET*

b. *he n-suub na-baar reʔ kintal na-tuin*

*he n-suba na-bara reʔ kintal na-tuin*

*IRR 3-bury 3-forever TOP yard 3-because*

‘They were at odds over father Fanu’s desire to permanently bury (him), in the yard because’

C Selected Amarasi texts

(23) *in aamf ii es anrenu ma nhain re' nopu,*

1.54 *iin aam-f=ii esa n-renu =ma n-hain re? nopu*  
*ini ama-f=ii esa n-renu =ma n-hani re? nopu*  
 3SG father-GEN=1DET one 3-order\U =and 3-dig TOP hole  
 'his father was the one who ordered (him), and he had dug the hole,'

(24) *anraem je nok.*

1.58 *a/n-raamč=ee n-ok*  
*n-rame=ee n-oka*  
 3-plaster=3SG.ACC 3-with  
 'and had also plastered it'

(25) *Onaim ana'a preent ein nmatoof ein et re' nee nok are' mahoint eni ma*

2.01 *onai =m ana?apreent=ein n-ma-toof=ein et re? nee n-ok*  
*onai =ma ana?aprenat=eni n-ma-tofa=eni et re? nee n-oka*  
 and.so official=PL 3-RECP-quarrel=PL IPFV.LOC REL 3DEM 3-with  
*are? mahoint=eni =m*  
*are? mahonit=eni =ma*  
 every parents=PL\U =and  
 'So (consequently) the government officials, they argued there with all the clan elders, and...'

(26) *nuuk tuaf eni, nai' Fanu nok are' in tataf*

2.05 *nuuk tua-f=eni, nai? Fanu n-ok are? iin tata-f*  
*nuka tua-f=eni nai? Fanu n-oka are? ini tata-f*  
 grief\M person-0GEN=PL\U Mr. Fanu 3-with every 3SG eSi-0GEN  
 'the bereaved, Mr. Fanu and with all his elder siblings,'

(27) *es-es ate nok in fee in mone,*

2.09 *es~esa =t n-ok iin fee iin mone*  
*es~esa =te n-oka ini fee ini mone*  
 INTNS~one =SUB 3-with 3SG wife 3SG husband  
 'each one (of them) with his wife or her husband,'

(28) *nasurin am ka tahiin he suubt ii on re' mee.*

2.11 *na-suri=n =am ka= ta-hiin he suub-t=ii on re? mee*  
*na-suri=n =ma ka= ta-hini he suba-t=ii on re? mee*  
 3-collide=PL =and NEG= 1PI-know IRR bury-NML=1DET like TOP how  
 'they were at odds and we didn't know where we would bury him.'

(29) *Ana'a preent ein naiti 'niimk ein am ka tahiin he*

2.16 *ana?apreent=ein n-aiti ?niim-k=ein =am ka= ta-hiin he*  
*ana?aprenat=eni n-aiti ?nima-k=eni =am ka= ta-hini he*  
 official=PL 3-lift hand-3PL/1GEN=PL and NEG= 1PI-know IRR

'The government officials lifted their hands (= didn't want to have anything more to do with it) and we didn't know whether '

(30) *urusan he reek haef, are' tobiru on tiis raur gui he on re' mee?*

2.28 a. *urusan re? he reek hae-f*  
*urusan re? he reka? hae-f*  
 dealings REL IRR order\M messenger-0GEN

'arrangements like sending messengers out (with news of the death),'

b. *are? tobiru on ahh tiis raargw=ii he on re? mee*  
*are? tobiru on tisi raru=ii he on re? mee*  
 every work IRR.LOC pour\M palm.wine=1DET IRR like TOP how

'every detail that had to be attended to, like (the ceremonial) pouring palm-wine, was going to happen how?'

(31) *Maut hena' tatniin sin.*

2.33 *maut hena? ta-tniin =siin*  
*maut hena? ta-tnina =sini*  
 let IRR 1PI-listen 3PL

'We really should listen to them.' (Deliberately vague.)

(32) *Aam Nahor Bani nmaet, in raisn ii 'tet-teta' kuun.*

2.35 a. *aam Nahor Bani n-maet*  
*ama Nahor Bani n-mate*  
 father\M Nahor Bani 3-die

b. *iin rais-n=ii ?tet-teta? kuu-n*  
*ini rasi-n=ii ?tet-teta? kuu-n*  
 3SG issue-3GEN=1DET INTNS~different alone-3GEN

'Father Nahor Bani died, and his issue (relating to his death) is entirely different by itself.'

## C.3 Moo'hitu'

### C.3.1 Metadata

|                    |                                                                                                                                                                                                                         |
|--------------------|-------------------------------------------------------------------------------------------------------------------------------------------------------------------------------------------------------------------------|
| File-name:         | aaz20120715_04                                                                                                                                                                                                          |
| Archive-link:      | <a href="http://catalog.paradisec.org.au/collections/OE1/items/aaz20120715_04">http://catalog.paradisec.org.au/collections/OE1/items/aaz20120715_04</a>                                                                 |
| Original Name:     | aaz-20120715-4-Nekmese-KusnawiBani-2                                                                                                                                                                                    |
| Language:          | Amarasi [aaz]                                                                                                                                                                                                           |
| Dialect:           | Kotos; Koro'oto hamlet                                                                                                                                                                                                  |
| Location:          | Nekmese', Amarasi Selatan, Kupang                                                                                                                                                                                       |
| Date:              | 15/07/2015                                                                                                                                                                                                              |
| Speaker(s):        | Taniel Feni, Kusnawi Bani, Heronimus Bani                                                                                                                                                                               |
| Recorded by:       | Daniel Kaufman, Heronimus Bani                                                                                                                                                                                          |
| Transcribed by:    | Yedida Ora                                                                                                                                                                                                              |
| Interlinear by:    | Owen Edwards                                                                                                                                                                                                            |
| Indonesian/Kupang: | Yedida Ora                                                                                                                                                                                                              |
| Free English by:   | Owen Edwards                                                                                                                                                                                                            |
| Genre:             | folk-tale                                                                                                                                                                                                               |
| Summary:           | Story of Moo'hitu', a mythical snake who created the world                                                                                                                                                              |
| Video:             | <a href="https://www.youtube.com/watch?v=Z_2D9WhYuuM&amp;list=PLcXFPx-z7B0q_2Ns3iYHigEY77DG4kXSU&amp;index=15">https://www.youtube.com/watch?v=Z_2D9WhYuuM&amp;list=PLcXFPx-z7B0q_2Ns3iYHigEY77DG4kXSU&amp;index=15</a> |

### C.3.2 Notes

The original recording contains a number of separate stories. I present here only the first story: the story of Moo'hitu'. This may be a conflation of two separate myths. The first is a creation myth about how Moo'hitu', a snake-like being, separates the sky, land, and sea. The second myth is about how a python copulated with women and is, perhaps, an explanation for the origin of men. In Timorese thought the human world cannot exist without women, who are the source of life. This leaves unexplained the origin of men.<sup>3</sup>

The information in the myth is incredibly dense in parts and certain information is left unexplained and/or assumed to be known by the hearers. Footnotes provide additional explanations as well as possible alternate readings.

---

<sup>3</sup>Thanks goes to James Fox for this explanation.



## C.3.3 The text

(33) *Neno naa pah-a'pinan ia, ankobub on bare mese'.*

0.05 *neno naa paha\_?pina-n ia a/n-kobub on bare mese?*  
*neno naa paha\_?pina-n ia n-kobub on bare mese?*  
 day 0DEM land\_below-3GEN 1DEM 3-piled.up IRR.LOC place one  
 'At that time this world was all piled up in one place'

(34) *Ka nmui' fa mainuan.*

0.10 *ka= n-mui? =fa maanuan*  
*ka= n-mu?i =fa mainuan*  
 NEG= 3-exist =NEG open  
 'there was no openness/space.'

(35) *Ka nmui' fa oe.*

0.13 *ka= n-mui? =fa oe*  
*ka= n-mu?i =fa oe*  
 NEG= 3-exist =NEG water  
 'There was no water.'

(36) *'Aa' oe ji nmees, ka tiit fa auf meto'.<sup>4</sup>*

0.14 *?aa? oodʒ=ii n-mees ka= tiit =fa auf meto?*  
*?a?a oe=ii n-mese ka= tita =fa afu meto?*  
 1SG-speak water=1DET 3-alone NEG= exist =NEG ground\M dry  
 'I say, there was only water, there was no dry ground.'

(37) *Afu ma neno nmanaa'.*

0.17 *K: afu =m neno n-ma-naa?*  
*afu =ma neno n-ma-na?a*  
 ground =and sky 3-RECP-hold  
 'The ground and sky held on to one another.'<sup>5</sup>

<sup>4</sup>Line (36): The meaning of initial phonetic [ʔa:ʔ] is currently unclear. It may be from the root *√a?a* 'ritual speech, poetic speech' and could, perhaps, mean something like 'I am telling it according to tradition'. In some other varieties of Meto *√a?a* simply means 'speak, talk'.

<sup>5</sup>Line (37) is spoken by Kusnawi Bani.

C Selected Amarasi texts

(38) *Afu ma neno nmanaa'. Meis'ookn ii nnaa'.*

0.18 T: *afu =m neno n-ma-naa? meis?ookn=ii n-naa?*  
*afu =ma neno n-ma-na?a meis?okan=ii n-na?a*  
 ground =and sky 3-RECP-hold dark=1DET 3-hold  
 'The ground and sky held on to one another, darkness held (fast).'

(39) *Tapi re' kauna' ia, in nmoni nbi oe ji naan ii.*

0.20 a. *tapi ahh re? kauna? ia*  
*tapi re? kauna? ia*  
 but REL snake 1DEM

b. *iin n-moni n-bi oodz=ee naan-n=ii,*  
*ini n-moni n-bi oe=ee nana-n=ii*  
 3SG 3-live 3-loc water=3DET inside-3GEN=1DET  
 'but as for this snake, he was living inside the water,'<sup>6</sup>

(40) *Noki-noki te, in naskeke nfena nhake ma,*

0.24 *noki-noki =te iin na-skeke n-fena n-hake =ma*  
 eventually =SUB 3SG 3-suddenly 3-rise 3-stand\U =and  
 'after a while, he suddenly stood up and'

(41) *in nfeen es mee te neon gui natsiri', natsiri', sampai in ntea re' aat neno nee msa', in natuin ee ma,*

0.27 a. *iin, iin n-feen es mee =t neengw=ii na-tsiri? na-tsiri?*  
*ini ini n-fena es mee =te neno=ii na-tsiri? na-tsiri?*  
 3SG 3SG 3-rise IPFV.LOC where =SUB sky=1DET 3-spread 3-spread  
 'as he went up to somewhere, the sky spread and spread (upwards)'<sup>7</sup>

b. *sampe iin n-tea re? aat neno nee msa?*  
*sampe ini n-tea re? ata neno nee msa?*  
 until 3SG 3-up.to REL up sky 3DEM also  
 'until when he arrived at (the place) where the top of the sky also is,'

c. *iin na-tuin=ee =ma*  
*ini na-tuin=ee =ma*  
 3SG 3-follow=3SG.ACC =and  
 'he followed it and,'

<sup>6</sup>Line (39): The snake is Moo'hitu'.

<sup>7</sup>Lines (41) and (42) explain how Moo'hitu' pushed up the sky, thus separating it from the water.

(42) *Anhake 'roo-roo te, es naa neon goe na' anmana'a ma,*

0.34 a. *a/n-hake ʔro~roo =t*  
*n-hake ʔro~roo =te*  
 3-stand INTNS~far =SUB

b. *es naa neengw=ee naʔ a/n-ma-naʔa =ma*  
*es naa neno=ee naʔ n-ma-naʔa =ma*  
 IPFV.LOC 0DEM sky=3DET then 3-RECP-hold\U =and

'when he had stood up for a long time, at that place only then the sky held fast (in relation to him) and,'

(43) *na' nsanu nfani kre'o-kre'o ma nfani nbi in baran.*

0.37 a. *naʔ n-sanu n-fani kreʔo~kreʔo =ma*  
*naʔ n-sanu n-fani kreʔo~kreʔo =ma*  
 then 3-descend 3-return FRD~bit =and

b. *n-fani n-bi iin bara-n*  
*n-fani n-bi ini bara-n*  
 3-return 3-RL.LOC 3SG place-3GEN

'then (he) went back down bit by bit and returned to his place'

(44) *Nfani nbi in baarn ii. In baarn ee et oe je nanan.*

0.40 a. *n-fani n-bi iin baar-n=ii*  
*n-fani n-bi ini bara-n=ii*  
 3-return 3-RL.LOC 3SG place-3GEN=1DET

b. *iin baar-n=ee et oodʒ=ee nana-n*  
*ini bara-n=ee et oe=ee nana-n*  
 3SG place-3GEN=3DET IPFV.LOC water=3DET inside-3GEN

'(He) went back to his place. His place was inside the water.'

(45) *Nbi-bi oe je naan ee onai te, anmo'e ma npoi jeen anbi meto'.*

0.43 a. *n-bi~bi oodʒ=ee naan-n=ee onai =te*  
*n-ni~bi oe=ee nana-n=ee onai =te*  
 3-INTNS~loc water=3DET inside3GEN=3DET then

'after he had been in the water for a while then,'

b. *a/nmoʔe =ma npoodʒ=ena n-bi metoʔ*  
*n-moʔe =ma n-poi=ena n-bi metoʔ*  
 3-do\U and 3-exit=INCEP 3-RL.LOC dry

'(he) made (dry land) and went out onto dry land,'

C Selected Amarasi texts

(46) *Npoi nbi meot' ee onai te, in ka nmui' fa bare he natua ma,*

0.47 a. *n-poi n-bi meot?=ee onai =te*  
*n-poi n-bi meto?=ee onai =te*  
 3-exit 3-RL.LOC dry=3DET then

b. *iin ka= n-mui? =fa bare he na-tua =m*  
*ini ka= n-mu?i =fa bare he na-tua =ma*  
 3SG NEG= 3-exist =NEG place IRR 3-live =and

'having gone out onto the dry land, he didn't have a place to live and,'

(47) *he natua te, baer mainuan.*

0.51 *he na-tua =te he- baer mainuan*  
*he na-tua =te bare mainuan*  
 IRR 3-live top place\M open

'he would (have to) live in an open place,'

(48) *Natua te, baer ko'u.*

0.53 *na-tua =te baer ko?u*  
*na-tua =te bare ko?u*  
 3-live =SUB place\M big

'live in a big place,'

(49) *Akhirnya, naim naan baer jes am namaika' nbi Smara' tunan.*

0.57 a. *ahirja ahh n-aim naan baardz=esa =m namaika? an-*,  
*ahirja n-ami naan bare=esa =ma na-maika?*  
 in.the.end 3-look.for 2DEM place=one =and 3-stay

'in the end, (he) looked there for a place and settled,'

b. *na-maika? n-bi Smara? tunan*  
*na-maika? n-bi Smara? tuna-n*  
 3-stay 3-RL.LOC Smara' top-3GEN

'(he) settled on top of Smara'.' (a headland on the southern coast)

(50) *Namaika' nbi Smara' tuun ee ma,*

1.01 *na-maika? n-bi Smara? tuun-n=ee =ma*  
*na-maika? n-bi Smara? tuna-n=ee =ma*  
 3-stay 3-RL.LOC Smara' top-3GEN=3DET =and

'settled on top of Smara' and'

(51) *In re' fee mnais unu' ma nai' unu' nnao nakbatun anbi tasi.*

- 1.05 a. *iin re? fee mnais unu? =ma nai? unu?*  
 ini re? fee mnasi? unu? =ma na?i unu?  
 3sg REL wife old\M past and grandfather\M past  
 'he (was) where old women of past times and old men of past times'  
 b. *n-nao na-kbatu=n a/n-bi tasi*  
 n-nao na-kbatu=n n-bi tasi  
 3-go 3-shell=PL 3-RL.LOC sea  
 'went and collected shells by the sea,'

(52) *Ntea uab reu'f ii jena ma.*

- 1.07 *n-tea uab reu'f=iidz=ena =ma ahh*  
 n-tea uaba re?uf=ii=ena =ma  
 3-arrive speech\M bad=1DET=INCEP =and  
 'he went there (to do things which are) bad to talk about.'<sup>8</sup>

(53) *In fee je msa' nua sin huma' mese' tapi bifee je bifee biasa.*

- 1.10 a. *iin feedz=ee msa? nua sin huma? mese?*  
 ini fee=ee msa? nua sin huma? mese?  
 3SG wife=3DET also two 3PL kind one  
 b. *tapi bifeedz=ee bifee biasa*  
 tapi bifee=ee bifee biasa  
 but woman=3DET woman normal  
 'he and his wife were the same, but the woman was a normal woman'<sup>9</sup>

(54) *Cuma atoin' ein ee nteek ee te nak: Moo'hitu'.*

- 1.14 *suma atoin?=ein=ee n-teek=ee =te n-ak: Moo?hitu?.*  
 suma atoni?=eni=ee n-teka=ee =te n-ak Moo?hitu?  
 only man=PL=3DET 3-call=3SG.ACC =SUB 3-QUOT Moo'hitu'  
 'Only the men called him Moo'hitu'.<sup>10</sup>

<sup>8</sup>Line (52) is obscure. It probably foreshadows that the actions Moo'hitu' is about to carry out are bad to talk about. Just after this line Kusnawi Bani says one or two inaudible words.

<sup>9</sup>Line (53a): The wife of Moo'hitu' has not been introduced before. The reference to her being a normal woman is probably a contrast with the fact that Moo'hitu' is a snake-like being.

<sup>10</sup>Line (54): that only the men call him Moo'hitu' is probably a reference to his phallic shape and/or nature.

C Selected Amarasi texts

(55) *Moo'hitu' re' naan, in kauna'.*

1.16 *Moo?hitu? re? naan iin kauna?*  
*Moo?hitu? re? naan ini kauna?*  
*Moo'hitu' REL 2DEM 3SG snake*  
 'That Moo'hitu' was/is a snake.'

(56) *Kauna', mes huum atoni' on re' hit.*

1.19 *kauna? mes huum atoni? on re? hiit*  
*kauna? mes huma? atoni? on re? hiti*  
*snake but face\M man like TOP 1PI*  
 '(He was) a snake but (he had) a human face/form like us.'

(57) *Cuma in kaan ee es re' nai' Moo'hitu'.*

1.22 *ʃuma iin kaan-n=ee ese? nai? Moo?hitu?*  
*ʃuma ini kana-n=ee esa re? nai? Moo?hitu?*  
*only 3SG name3GEN=3DET COP REL Mr. Moo'hitu'*  
 'It was only his name which was Moo'hitu.'

(58) *In nfena nhake te, mo'ok hitu, mes ho muhiin he moo'k es ate, he mnaun' ii ba'uk.*

1.24 a. *iin n-fena n-hake =t mo?ok hitu*  
*ini n-fena n-hake =te mo?ok hitu*  
*3SG 3-rise 3-stand\U =SUB section seven\U*  
 'If he stood up (there would be) seven sections,'<sup>11</sup>

b. *mes hoo mu-hiin he moo?k=esa =t he mnaun?=ii ba?uk*  
*mes hoo mu-hini he mo?ok=esa =te he mnanu?=ii ba?uk*  
*but 2SG 2SG-know IRR section=one =SUB IRR long=1DET several*  
 'but if you know (the length of) one section, it would be very long.'<sup>12</sup>

(59) *Akhirnya in nhake nbi Smara' tuun ee te, bifee ngguin nakbatun nbi nahen nee kboa' ko'u.*

1.30 a. *ahirʒa iin n-hake n-bi Smara? tuun-n=ee =te*  
*ahirʒa ini n-hake n-bi Smara? tuna-n=ee =te*  
*in.the.end 3SG 3-stand 3-RL.LOC Smara' top-3GEN=3DET =SUB*  
 'In the end while he was standing on top of Smara','

<sup>11</sup>Line (58a): an explanation of the name Moo'hitu'. It is from the root *mo?ok* 'section of something long; joints of a finger, nodes of bamboo' and *hitu* 'seven'.

<sup>12</sup>Line (58b): Moo'hitu' is so long, that it is hard to know how long even a single section of him would be.

- b. *bifée=ngwein na-kbatu=n n-bi nahen nee kboa? ko?u*  
*bifée=eni na-kbatu=n n-bi nahe-n nee kbo?es ko?u*  
 woman=PL 3-shell-PL 3-RL.LOC down-3GEN 3DEM clump\M big  
 'the women were collecting sea shells down there in a big clump.'

(60) *In naim ranan huma'-huma' akhirnya,*

- 1.34 *iin n-aim ranan huma?-huma? ahirpa*  
*ini n-ami ranan huma?-huma? ahirpa*  
 3SG 3-look.for road FRD-kind in.the.end  
 'he was looking for various ways, and in the end,'

(61) *permisi, ma re' in nnao npeo' afu, nmoe' on umeek ji ma,*

- 1.37 a. *permisi =m re? iin nahh hihh*  
*permisi =ma re? ini*  
 excuse.me =and REL 3SG  
 'excuse me, and it was where he, uhh'<sup>13</sup>
- b. *iin n-nao n-peo? afu n-moa? on umeekǵ=ii =ma*  
*ini n-nao n-pe?o afu n-mo?e on umeke=ii =ma*  
 3SG 3-go 3-go.by ground 3-do like wolf.snake=1DET =and  
 'he went along the ground he was doing it like the wolf snake,'<sup>14</sup>

(62) *in tuan ii nbi ata 'toe'f ee tuun ee te, in aon ee es anaot ma,*

- 1.42 a. *iin, iin tua-n=ii n-bi ata ?toe?f=ee*  
*ini ini tua-n=ii n-bi ata ?to?ef=ee*  
 3SG 3SG self-3GEN=1DET 3-RL.LOC up mountain=3DET  
*tuun-n=ee =t*  
*tuna-n=ee =te*  
 top-3GEN=3DET =SUB  
 'while his self was up on top of the mountain,'
- b. *iin ao-n=ee ees a-nao-t =ma*  
*ini ao-n=ee ees a-nao-t =ma*  
 3SG body-3GEN=3DET COP NML-go-NML =and  
 'his body (was the) one which went and'

<sup>13</sup>Line (61a): The narrator uses *permisi* to signal that he is about to talk of sexual matters.

<sup>14</sup>Line (61b): *umeke* = *Lycodon sp.*, a kind of non-poisonous red snake

C Selected Amarasi texts

- (63) *in nkoin re' bifee ngguin nbi tasi.*
- 1.46 *iin n-koin re? bifee=ngwein n-bi tasi*  
*ini n-koni re? bifee=eni n-bi tasi*  
 3SG 3-copulate TOP woman=PL 3-RL.LOC sea  
 'he copulated with those women at the sea.'
- (64) *Ka nakeon fa.*
- 1.48 *ka= na-keo=n =fa*  
*ka= na-keo=n =fa*  
 NEG= 3-aware=PL =NEG  
 'They weren't aware of it.'
- (65) *In a'maen ii es anpeo' afu. In nmoe' jon on kaun' ii ma, nnonok anpeo' auf*  
*gui ma,*
- 1.49 a. *iin, iin, ina ?-mae-n=ii esa n-peo? afu*  
*ini ini ina ?-mae-n=ii esa n-pe?o afu*  
 3SG 3SG 3SG NML-shame-3GEN=1DET COP 3-go.by ground  
 'his private part was the one which went along the ground.'
- b. *iin n-moo?dʒ=oo-n on kaun?=ii =ma*  
*ini n-mo?e=oo-n on kauna?=ii =ma*  
 3SG 3-do=REFL-3GEN like snake=1DET =and  
 'he made himself like a snake and,'
- c. *n-nonok a|n-peo? aafgw=ii =ma*  
*n-nonok n-pe?o afu=ii =ma*  
 3-crawl 3-go.by ground=1DET =and  
 'crawled along the ground and,'
- (66) *nnaob antama ma, in nkoin re' bifee ngguin. Sin nakeon fa.*
- 1.55 a. *n-nao-b a|n-tama =m, iin n-koin re? bifee=ngwein*  
*n-nao-b n-tama =ma ini n-koni re? bifee=eni*  
 3-go-TR 3-enter\U =and 3SG 3-copulate TOP woman=PL  
 '(he) made (it) go (and) penetrate and he copulated with the women'
- b. *siin ka= na-keo=n =fa*  
*sini ka= na-keo=n =fa*  
 3PL NEG= 3-aware=PL =NEG  
 'they weren't aware of it'



## C.4 A car accident

### C.4.1 Metadata

|                    |                                                                                                                                                         |
|--------------------|---------------------------------------------------------------------------------------------------------------------------------------------------------|
| File-name:         | aaz20130911_02                                                                                                                                          |
| Archive-link:      | <a href="http://catalog.paradisec.org.au/collections/OE1/items/aaz20130911_02">http://catalog.paradisec.org.au/collections/OE1/items/aaz20130911_02</a> |
| Original Name:     | aaz-20130911-2-DominggusBani-HenkiOra-CeritaOtoJato                                                                                                     |
| Language:          | Amarasi [aaz]                                                                                                                                           |
| Dialect:           | Kotos; Koro'oto hamlet                                                                                                                                  |
| Location:          | Nekmese', Amarasi Selatan, Kupang                                                                                                                       |
| Date:              | 11/09/2013                                                                                                                                              |
| Speaker(s):        | Dominggus Bani (D), Heronimus Bani (R), Henki Ora (H), Sefnat Bois, and occasional others                                                               |
| Recorded by:       | Heronimus Bani                                                                                                                                          |
| Transcribed by:    | Heronimus Bani                                                                                                                                          |
| Interlinear by:    | Owen Edwards                                                                                                                                            |
| Indonesian/Kupang: | Heronimus Bani                                                                                                                                          |
| Free English by:   | Owen Edwards                                                                                                                                            |
| Genre:             | conversation                                                                                                                                            |
| Summary:           | conversation about a car accident                                                                                                                       |

### C.4.2 Notes

This text is a conversation about a recent car crash. As is to be expected from natural free-flowing conversation, there are many instances in which more than one person is speaking at once. Given this, it was not possible for the transcriber (Heronimus Bani) to transcribe every voice at every point in the recording. I have listened through the entire text several times and edited where necessary. Where there is doubt over the exact transcription, I have deferred to the original.

The three dominant participants are Dominggus Bani (D), Heronimus Bani (R) and Henki Ora (H). Names of other participants are given in full before their contributions. When a speaker makes multiple consecutive contributions, only the first contribution is marked. The recording begins after the conversation has begun and the topic of conversation has been established.

C.4.3 The text

(67) R: *Onai te ma saa', naa,*

0.00 *onai =t, onai =t, =ma, =ma, saa? naa*  
*onai =te onai =te =ma =ma saa? naa*  
 and.then and.then =and =and what well  
 ‘and then, and then, and, and what, well’

(68) *kedalaman ma'boik' ee, keefn ii mnanu'.*

0.03 *kedalaman ma?boik?=ee keefn=ii mnanu?*  
*kedalaman ma?boki?=ee kefan=ii mnanu?*  
 deep suspended=3DET gap=1DET deep  
 ‘(it was) deep (the car) was suspended, the gap was deep.’

(69) D: *Re' natoon ii nak am, pas anritu' neu re' mnaun' ii jeen am, ka tahini mnaun' ii basik ate, ka tahiin, neor hit toka ma, es he tahiin.*

0.05 a. *re? na-toon=ii n-aka =m,*  
*re? na-tona=ii n-aka =ma*  
 REL 3-tell=1DET 3-say =and  
 ‘That’s what they said,’

b. *pas a/n-ritu? n-eu re? mnaun?=iick=ena =m,*  
*pas n-ritu? n-eu re? mnanu?=ii=ena =ma*  
 exact 3-roll 3-DAT TOP deep=1DET=INCEP =and  
 ‘and it rolled exactly into the deep space’

c. *ka= ta-hini mnaun?=ii basik =at,*  
*ka= ta-hini mnanu?=ii basik =te*  
 NEG= 1PI-know depth=1DET how.much =SUB  
 ‘we don’t know how deep it was’

d. *ka= ta-hiin, neor hiit t-oka =m es he ta-hiin*  
*ka= ta-hini nero hiit t-oka =ma es he ta-hini*  
 NEG= 1PI-know not 1PI 1PI-with\U =and one IRR 1PI-know  
 ‘we don’t know, we weren’t with (them) to know’

0.10

(70) *Mnanu', oot goe, nak sin na' nateut oto.*

0.12 *mnanu? ootgw=ee n-ak siin na? na-teut oto*  
*mnanu? oto=ee n-ak sini na? na-tetu oto*  
 deep car=3DET 3-say 3PL then 3\TR-upright car  
 ‘(It was) deep, the car, they said they then stood the car upright’

(71) R: *Sekau es neki?*

0.15 *sekau ees n-eki*  
 sekau esa n-eki  
 who COP 3-bring\U  
 ‘Who was the one driving?’

(72) Sefnat Bois: *Cuma mana fa te, nmouf goen ate,*

0.16 *suma nehh, mana =fa =te n-moofgw=ena =te*  
 suma mana =fa =te n-mofu=ena =te  
 only like.that =NEG =SUB 3-fall=INCEP =SUB  
 ‘Only, umm, when (it was) like that, when it fell,’

(73) R: *Rem ee naah mes,*

0.18 *reem=ee na-ah mes*  
 reem=ee na-ah mes  
 brakes=3DET 3-eat but  
 ‘the brakes failed? but...’

(74) H: *Rem ee naah. Sementara n'antareek.*

0.19 *reem=ee na-ah sementara n-?antareek*  
 reem=ee na-ah sementara n-?antareek  
 brakes=3DET 3-eat during 3-backing  
 ‘The brakes failed, while they were backing.’

(75) R: *Ohh, sementara n'antareek.*

0.21 *ohh, sementara n-?antareek*  
 sementara n-?antareek  
 oh during 3-backing  
 ‘Oh, while they were backing.’

(76) H: *Jadi, in ka nakeo fa mnaun he-*

0.23 *ɟɟadi iin ka= nauhh ka= na-keo =fa mnaun he-*  
 ɟɟadi ini ka= ka= na-keo =fa mnanu?  
 so 3SG NEG= umm NEG= 3-be.aware =NEG deep\M  
 ‘So, he wasn’t, wasn’t aware (it was) deep’

C Selected Amarasi texts

(77) *Posisi n'antareek in ka bisa nbi fa nee, saap ma'bake'.*

0.25 a. *posisi n-?antareek iin ka= bisa n-bi =fa nee*  
*posisi n-?antareek ini ka= bisa n-bi =fa nee*  
 posisi 3-backing 3SG NEG= able 3-RL.LOC =NEG 3DEM  
 'His position was backing, he couldn't get there'

b. *saap ma?bake?*  
*saap ma?bake?*  
 because narrow  
 'because it was narrow.'

(78) *Bait in he naim bare hena' n'antareek ate, bisa.*

0.28 *bait iin he n-aim bare hena? n-?antareek =at, bisa.*  
*bait ini he n-ami bare hena? n-?antareek =te bisa*  
 actually 3SG IRR 3-look.for place IRR 3-backing =SUB able  
 'Actually if he had looked for a place to back, he could have'

(79) R: *In nareen on ma n'antareek anbi n-*

0.31 *iin na-reen=oo-n =ma n-?antareek a/n-bi n-*  
*ini na-rena=oo-n =ma n-?antareek n-bi*  
 3SG 3-force=REFL=3GEN =and 3-backing 3-RL.LOC  
 'He forced himself, and went back into it, he was in...'

(80) H: *Nabara ma'bake'.*

0.32 *na-bara ma?bake?*  
*na-bara ma?bake?*  
 3-forever\U narrow  
 'He was stuck in the narrow (place)'

0.32

(81) Sefnat Bois: *In he nbibi.*

0.34 *iin he n-bibi*  
*ini he n-bibi*  
 3SG IRR 3-shrink \U  
 'He would've wanted to shrink (the car)'

(82) D: *Nak, ootgw=ii na-snii m-ak, am, nakamaf am,*

0.35 *n-ak, ootgw=ii na-snii m-ak, =am, na-kamaf =am*  
*n-ak oto=ii na-snii m-ak =ma na-kamaf =ma*  
 3-say car=1DET 3-slope 1PX/2-say and 3-what's.it =and  
 'he said, the car was sloping, you think, and what's it and'

- (83) *nasnii, ntaikobi nkoon, na' natetu.*
- 0.38 *na-snii n-taikobi n-koon, na? na-tetu*  
*na-snii n-taikobi n-kono na? na-tetu*  
 3-slope 3-fall 3-keep.on then 3\TR-upright\U  
 'it was sloping, fell over, kept on, and only then he got the car upright'
- (84) H: *Onai ma, srutun re' ia, in nmouf goen.*
- 0.40 *onai =ma srutun re? ia, iin n-moofgw=een*  
*onai =ma srutun re? ia ini n-mofu=ena*  
 and.so suddenly REL 1DEM 3SG 3-fall=INCEP  
 'and suddenly like this, it fell down'
- (85) Sam Ora: *Oh, mak oot gui in nmeso nnao kuun.*
- 0.42 *ohh, m-ak, ootgw=ii iin n-mese n-nao kuu-n*  
*m-ak oto=ii ini n-mese n-nao kuu-n*  
 oh 1PX/2-say car=1DET 3SG 3-alone 3-go alone-3GEN  
 'Oh, you think the car went by itself.'
- (86) R: *Mak, sofir ii nmouf goen?*
- 0.43 *m-ak ahh, sofir=ii n-moofgw=een*  
*m-ak sofir=ii n-mofu=ena*  
 1PX/2-say driver=1DET 3-fall=INCEP  
 'Do you think the driver fell?'
- (87) Stef Ora: *Tua.*
- 0.45 *tua*  
 ADDR  
 'yes'
- (88) R: *Tuan?*
- 0.46 *tua-n*  
 owner-3GEN  
 '(did you say) its owner?'
- (89) H: *Onaim, in nmeo te, oot gui in nmeso ntaikob-koib.*
- 0.47 *onai =m iin n-meo =t, ootgw=ii iin n-mese n-taikob~koib*  
*onai =m ini n-meo =te oto=ii ini n-mese n-taikob~kobi*  
 and.so 3SG 3-see =SUB car=1DET 3SG 3-alone 3-INTNS~fall  
 'And so when he saw it, the car fell down by itself'

C Selected Amarasi texts

(90) D: *Onai te, oirf ii nok aanh ii sin nbin belakang.*

0.52    *onai =te oir-f=ii            n-ok    aanh=ii    siin n-bi=n    a|blakan*  
           *onai =te ori-f=ii            n-oka    anah=ii    sini n-bi=n    blakan*  
           and.then ySi-0GEN=1DET 3-with child=1DET 3PL 3-RL.LOC=PL    back  
           ‘and his younger brother with his child were in the back (of the car)’

(91) R: *Orif Joni.*

0.52    *ori-f    Joni.*  
           *ori-f    Joni*  
           *ySi-GEN Joni*  
           ‘the younger brother was Johnny.’ 0.52

(92) D: *Tuan ii nnaben ate oni' maineun' een ate,*

0.52    *tua-n=ii,                    n-naben =at    oni?    maineun?=ena    =te.*  
           *tua-n=ii                    n-naben =te    oni?    mainenu?=ena    =te*  
           owner-3GEN=1DET 3-feel    =SUB maybe wide.length=INCEP =SUB  
           ‘The owner, maybe he felt as though there was enough space’

(93) *Tuan ii nnaben ate mnaun' een, ro in nrete npoi kuun.*

0.55    a. *tua-n=ii                    n-naben =at    mnaun?=een*  
           *tua-n=ii                    n-naben =te    mnanu?=ena*  
           owner-3GEN=1DET 3-feel    =SUB deep=INCEP  
           ‘The owner felt it was (too) deep,’  
           b. *ro    iin n-rete    n-poi    kuu-n.*  
           *ro    ini n-rete    n-poi    kuu-n*  
           must 3SG 3-jump    3-exit alone-3GEN  
           ‘he had to jump out by himself’

(94) R: *Aina, in nasaeb ba'-ba'uk atoin' ein?*

1.00    *aina,    iin na-sae-b    ba?~ba?uk    atoin?=ein*  
           *aina    ini na-sae-b    INTNS~ba?uk atoni?=eni*  
           mother 3SG 3-go.up-TR prd-several    man=PL  
           ‘Oh my, how many people was he carrying?’

(95) D: *Molak am, muhiin he,*

1.01    *molak =am mu-hiin    he*  
           *molak =ma mu-hini    he*  
           *log    and 2SG-know IRR*  
           ‘(he was carrying) logs, and you know...’

(96) R: *Ma'fena'*.

1.04 *maʔfenaʔ*  
*maʔfenaʔ*  
 heavy  
 'heavy'

(97) H: *In nak fe' nasaeban naan tuka' bo' esa?*

1.05 *iin n-ak feʔ na-sae-ba=n naan tukaʔ boʔ=esa*  
*ini n-ak feʔ na-sae-ba=n naan tukaʔ boʔ=esa*  
 3SG 3-say still 3\TR-go.up-TR=PL 2DEM slice ten=one\U  
 'he said, he was carrying ten of them, right?'

(98) R: *Tuka' bo' es, mes mainenu'!*

1.09 *tukaʔ boʔ ees, mes mainenuʔ*  
*tukaʔ boʔ esa mes mainenuʔ*  
 slice ten one but wide.length  
 'Ten of them. But that's too much!'

(99) H: *Onai te, nak posisi n'antareek in nasaeba' nteni'.*

1.10 *onai =t n-ak posisi n-ʔantareek iin na-sae-baʔ n-teniʔ,*  
*onai =te n-ak posisi n-ʔantareek ini na-sae-TR n-teniʔ*  
 and.then 3-say position 3-backing=1DET 3SG 3\TR-go.up-TR 3-again  
 'And then he said he was backing, he was carrying more'

(100) R: *He nteni'.*

1.13 *he n-teniʔ*  
*he n-teniʔ*  
 IRR 3-again  
 'He wanted more.'

(101) D: *Tasaeba' molak on re' nee ja te, ma'fena'.*

1.13 *ta-sae-baʔ molak on reʔ neeʔ=aa =t maʔfenaʔ*  
*ta-sae-baʔ molak on reʔ nee=aa =te maʔfenaʔ*  
 0-go.up-TR log like TOP 3DEM=0DET =SUB heavy  
 'carrying logs like that, it's heavy'

(102) Rehuel Nakmofa: *Ma'fena', papan re',*

1.15 *maʔfenaʔ, papan reʔ*  
 heavy plank REL  
 'heavy, planks which ...'

C Selected Amarasi texts

(103) D: *Papan, fe' papan noo nautn es, ma'kafa' fe'.*

1.17 *mahh papan, fe? noo nautn-, papan noo nautn=ees,*  
*papan fe? noo papan noo natun=ees*  
*plank still COUNT plank COUNT hundred=one*  
*ma?kafa? fe?*  
*ma?kafa? fe?*  
*light still*

'Umm, planks, still a hundred, a hundred planks is still light!'

(104) H: *Onai te, hi misaah miit noo nautn es!*

1.21 *onai =t na? hii mi-saah m-iit noo nautn=ees*  
*onai =te na? hii mi-saha m-ita noo natun=ees*  
*and.then 2PL 1PX/2PL-carry 1PX/2-try COUNT hundred=one*

'Well then, why don't you try and carry a hundred planks?'

1.23 [laughter]

(105) D: *Aah, hit taret'a' nok oot goe ma hi ta'uab,*

1.24 *aah, hiit ta-reta? n-ok ootgw=ee =ma hiit ta-?uab ...*  
*hiit ta-reta? n-oka oto=ee =ma hiit ta-uaba*  
*ah 1PI 1PI-story 3-with car=3DET =ma 1PI 1PI-speak*

'Ah yes! But we're talking about the car! And we're talking ...'

1.26 [laughter]

(106) H: *Au 'ak, hi misoba' noo nautn es.*

1.28 *au ?-ak hii m-soba? noo nautn=ees*  
*au ?-ak hii m-soba? noo natun=ees*  
*1SG 1SG-say 2PL 1PX/2-try COUNT hundred=one*

'I said, you try (and carry) a hundred of them'

(107) D: *Sonde, no nautn es ate, oot gui ma'kaaf ii, naena te, mainenu'.*

1.30 *sonde, noo nautn=esa =t ootgw=ii ma?kaaf?=ii*  
*sonde noo natun=esa =te oto=ii ma?kafa?=ii*  
*not COUNT hundred=one\U =SUB car=1DET light=1DET*  
*n-aena =t, mainenu?*  
*n-aena =te mainenu?*  
*3-run\U =SUB excessive*

'No, a hundred of them, (in) the car is light, (it) goes quickly, too much'



(108) R: *Onaim, ameent ee neu haa nai' Firgo.*

- 1.33     *onai =m, mhh, a-meen-t=ee           n-eu =ha nai? Firgo*  
           *onai =m        a-mena-t=ee           n-eu =ha nai? Firgo*  
           and.so         NML-sick-NML=3DET 3-DAT =only Mr. Firgo  
           ‘And so, umm, the only one injured is Firgo.’

(109) Rehuel Nakmofa: *Firgo nmees.*

- 1.35     *Firgo n-mees*  
           *Firgo n-mese*  
           *Firgo 3-alone*  
           ‘Just Firgo.’

(110) R: *On dusun, tak, asaunt ee, nua sin oirf ii ka saa'.*

- 1.36     a. *on        nehh, dusun, eh, t-ak       a-saun-t=ee*  
           *on           dusun        t-ak       a-sanu-t=ee*  
           IRR.LOC        county       1PI-QUOT NML-descend-NML=3DET  
           ‘Like, umm, the county (head), the one who fell down,’  
           b. *nua siin oir-f=ii       ka=   saa?*  
           *nua sini ori-f=ii       ka=   saa?*  
           two 3PL ySi-GEN=1DET NEG= what  
           ‘nothing happened to those two kids.’

(111) Rehuel Nakmofa: *Nak ka saa' fa.*

- 1.40     *n-ak, ka=   saa? =fa*  
           *n-ak ka=   saa? =fa*  
           3-say NEG= what =NEG  
           ‘they said nothing happened (to them)’

(112) Adi Bani: *Nok keun' aa te ean' ee nasoin.*

- 1.41     *n-ok   keun? =at, ean?=ee   na-soin*  
           *n-oka   kenu? =te   eno?=ee   na-soni*  
           3-with fortune =SUB door=3DET 3-open  
           ‘It’s fortunate, the door opened’

(113) R: *Neu reko.*

- 1.43     *neu   reko*  
           *neu   reko*  
           already good  
           ‘Well, good.’

## C.5 Gatmel Bana's family (Ro'is)

### C.5.1 Metadata

|                  |                                                                                                                                                                                   |
|------------------|-----------------------------------------------------------------------------------------------------------------------------------------------------------------------------------|
| File-name:       | aazRO20170901_GatmelFamily                                                                                                                                                        |
| Archive-link:    | <a href="https://catalog.paradisec.org.au/collections/OE2/items/aazRO20170901_GatmelFamily">https://catalog.paradisec.org.au/collections/OE2/items/aazRO20170901_GatmelFamily</a> |
| Original Name:   | aaz-RO-20170901-1-GatmelBana-VillageFamily                                                                                                                                        |
| Language:        | Amarasi [aaz]                                                                                                                                                                     |
| Dialect:         | Ro'is; Batuna hamlet                                                                                                                                                              |
| Location:        | Desa Tunbaun, Amarasi Barat, Timor, Indonesia                                                                                                                                     |
| Date:            | 01/09/2017                                                                                                                                                                        |
| Speaker(s):      | Gatmel Daniel Bana', Melianus Obhetan<br>(introduction 0.01–1.01)                                                                                                                 |
| Recorded by:     | Owen Edwards, Melianus Obhetan                                                                                                                                                    |
| Transcribed by:  | Owen Edwards                                                                                                                                                                      |
| Interlinear by:  | Owen Edwards                                                                                                                                                                      |
| Free English by: | Owen Edwards                                                                                                                                                                      |
| Checked:         | Unclear sections checked by Owen Edwards with Melianus Obhetan.                                                                                                                   |
| Genre:           | narrative                                                                                                                                                                         |
| Summary:         | Gatmel talks about his family and its history.                                                                                                                                    |

### C.5.2 The text

Melianus Obhetan:

(114) *Mabe' ai hai mi'euk ma miteef, hai mibua ek maam Rosalin Honin hin uim  
ji natuina', hin ulang tahun*

0.05 *mabe? ai hai mi-?euk =ma mi-teef hai mi-bua*  
*mabe? ai hai mi-?eku =ma mi-tefa hai mi-bua*  
 evening 1DEM 1PX 1PX/2PL-meet =and 1PX/2PL-meet 1PX 1PX/2PL-gather  
*ek maam Rosalin Honin hiin uumɔ́=ii na-tuina? hiin ulan tahun*  
*ek mama Rosalin Honin hini umi=ii na-tuina? hini ulan tahun*  
 LOC mum\M Rosalin Honin 3SG house=1DET 3-follow 3SG birthday  
 'This evening we have met together, we have gathered at Rosalin Honin's  
 house because it is her birthday.'

- (115) *Mese' nmui' tuaf nu na'uab naan,*  
 0.14 *mese? ahh n-mui? ahh tuaf nu na-ʔuab n-aan*  
*mese? n-muʔi tuaf nu na-ʔuaba n-ana*  
*but 3-exist person IRR 3-speak 3-RES*  
 'But there is a person who wants to speak,'
- (116) *Henati' nataam hin haann ii nbi'aka reta'.*  
 0.20 *henati? na-taam hiin haan-n=ii n-biʔaka ahh reta?*  
*henati? na-tama hini hana-n=ii n-biʔaka reta?*  
*IRR 3\TR-enter 3SG voice-3PSR;SG.PSM=1DET 3-RL.LOC story*  
 'to put his voice in a story.'
- (117) *Etu naa neno ai tanggal satu September.*  
 0.25 *etu\_naa neno ai tanggal satu September*  
*therefore day 1DEM date one September*  
 'Because of that, today is the first of September.'
- (118) *Tanggal satu fuun se'o.*  
 0.30 *tanggal satu fuun fe- se<ʔ>o*  
*tanggal satu funan nine <ORD>*  
*tanggal satu month\M nine <ORD>*  
 'The first of September (*lit.* ninth month).'
- (119) *Ka'uab ii hin kaann ii Gatmel Daniel Bana'.*  
 0.33 *ahh ka-ʔuab=ii hiin kaan-n=ii Gatmel Daniel Bana?*  
*ka-ʔuaba=ii hini kana-n=ii Gatmel Daniel Bana?*  
*NML-speak=1DET 3SG name-3PSR;SG.PSM=1DET Gatmel Daniel Bana'*  
 'The one speaking's name is Gatmel Daniel Bana.'
- (120) *Maam Rosalin hin tuuhaon aa.*  
 0.37 *maam Rosalin hiin tuuhao-n=aa*  
*mum\M Rosalin 3SG brother-3PSR;SG.PSM=0DET*  
 'Rosalin's brother.'

C Selected Amarasi texts

(121) *Na'uab natuina' sin moindr ini nok sin nai'ik, sin ama'.*

0.41 *na-ʔuab na-tuina? siin moindr=ini n-oko ahh*  
*na-ʔuaba na-tuina? sini moni-r=ini n-oko*  
 3-speak 3-follow 3PL life-3PSR;PL.PSM=PL\U 3-ABL  
*siin naiʔik siin ama?*  
*sini naiʔik sini ama?*  
 3PL PF 3PL father

‘(He will) speak about their lives from their grandfather and their father.’

(122) *Nu nai' nnao ntookn ek ahh preent Niin-Ri'in.*

0.46 *nu\_nai? n-nao n-took=n ek ahh preent Niin-Ri'in*  
*nu\_nai? n-nao n-toko=n ek prenat Niin-Ri'in*  
 then 3-go 3-sit=PL LOC government Niin-Ri'in

‘and then go on to (talk) about occupying the government of Niin-Ri'in.’

(123) *Nu nai' oka te, sin maam Ros nai'...*

0.50 *nu\_nai? oka te siin ahh maam Ros nai?*  
*nu\_nai? oke? =te sini mama Ros nai?*  
 then after.that 3PL mum\M Ros Mr.

‘Then after that, their ahh, Rosalin...’

(124) *Maam Rosalin he' ai nfain neem ek sin ruan ma sin bare ek ruan Nai'bana'.*

0.55 *ahh maam Rosalin he? ai n-fain neem ek siin ruan =ma siin*  
*mama Rosalin he? ai n-fani nema ek sini ruan =ma sini*  
*mum\M Rosalin REL 1DEM 3-return 3\come LOC 3PL village =and 3PL*  
*bare ek ruan Nai'bana?*  
*bare ek ruan Nai'bana?*  
 place LOC village Nai'bana'

‘how Rosalin here came back to their village and their place at the village of Nai'bana.’

(125) *Silahkan.*

1.01 *silahkan*  
 please

‘Please begin!’

Gatmel Daniel Bana':

1.07 *ahh*

(126) *Eti fuun tabu ai, au nu 'peo kutonon, hit aan moen ji, kaes muti'.*

1.09 *eti fuun tabu ai au nu ?-peo ku-tono=n hiit aan*  
*eti funan tabu ai au nu ?-peo ku-tona=n hiti ana?*  
 time month\M time 1DEM 1SG IRR 1SG-speak 1SG-tell=PL 1PI child  
*moonɔ̃=ii kaes muti?*  
*mone=ii kase muti?*  
 male=1DET foreign\M white

'at this moment and time of month I want to talk and tell (a story to) our son, the European.'

1.17 *ahh*

(127) *Yang sebenarnya hai moko hai ruan aa es he' ai.*

1.19 *jaŋ sebenarnya hai m-oko hai ruan=aa ese? ai*  
*jaŋ sebenarnya hai m-oko hai ruan=aa esa he? ai*  
 REL truly 1PX 1PX/2-ABL 1PX village=0DET COP REL 1DEM

'In truth we are from our village which is here.'

(128) *Tetapi, et au bapa sin, mana' niim, sin feotr iin teun.*

1.23 *tetapi et au bapa siin mana? niim siin feot-r=iin teun*  
*tetapi et au bapa sini mana? nima sini feto-r=ini tenu*  
 but LOC 1SG dad ASSOC.PL COUNT five 3PL mS-3PSR;PL.PSM=PL three

'But with my dad (and family) there are five of them, they have three sisters'

(129) *Au bapa es moen muni'.*

1.32 *au bapa ees moen muni?*  
*au bapa esa mone muni?*  
 1SG father COP male\M young

'My dad is the youngest man.'

(130) *Es nakauhub au bapa ek nakaf Niin-Ri'in.*

1.36 *ees na-kāuhu-b au bapa ek naka-f Niin-Ri'in*  
*esa na-kahu-b au bapa ek naka-f Niin-Ri'in*  
 one 3\TR-adopt-TR 1SG dad LOC head-0GEN Niin-Ri'in

'My father was adopted into the head (top) of the village of Niin-Ri'in.'

C Selected Amarasi texts

(131) *Hai mtook ek naa sampai toon bo' es am hiut eeh,*

1.43 *hai m-took ek naa sampai toon bo? esa =m hiut ehh*  
*hai m-toko ek naa sampai toon bo? esa =m hitu*  
 1PX 1PX/2-sit LOC 0DEM until year ten one\U =and seven  
 'We lived there until the year of '17 (2017).'

(132) *Hai ruan=ee n-reef.*

1.49 *hai ruan=ee n-reef*  
*hai ruan=ee n-refa*  
 1PX village=3DET 3-landslide  
 'Our village was affected/destroyed by a landslide.'

(133) *Hai ruan ee nreef ma,*

1.51 *hai ruan=ee n-reef =ma*  
*hai ruan=ee n-refa =ma*  
 1PX village=3DET 3-landslide =and  
 'Our village was affected by a landslide and'

(134) *oka te hai uim ji naann ii,*

1.53 *oka =t hai uumɔ́=ii naan-n=ii*  
*oke? =te hai umi=ii nana-n=ii*  
 after.that 1PX house=1DET inside-3PSR;SG.PSM=1DET  
 'after that those of us in our house,'

(135) *hai iim ek hai ruan he' hai bapa nmoin je es he' ai.*

1.54 *hai iim ek hai ruan he? hai bapa n-moondɔ́=ee ese? ai*  
*hai ima ek hai ruan he? hai bapa n-moni=ee esa he? ai*  
 1PX 1PX\come LOC 1PX village REL 1PX dad 3-live=3SG.ACC COP REL 1DEM  
 'we came to our village where our dad lives which is here'

(136) *Es hai mmoe' hai umi ai, meter bo' es nok meter nee.*

1.58 *ees hai m-moe? hai umi ai meter bo? ees n-ook meter nee*  
*esa hai m-mo?e hai umi ai meter bo? esa n-oka meter nee*  
 one 1PX 1PX/2-make 1PX house 1DEM metre ten one 3-with metre six  
 'We made our house here [points to house], ten metres by six metres.'

- (137) *Oka te hai mitua ok-oke' ek he' ai.*  
 2.02 *oka =te hai mi-tua ok~oke? k he? ai*  
*oke? =te hai mi-tua ok~oke? ek he? ai*  
 after.that 1PX 1PX/2PL-settle INTNS~all LOC TOP 1DEM  
 'After that we all lived here.'
- (138) *Setelah hai mitua ok-oke' ek he' ai ma,*  
 2.04 *setela hai mi-tua ok~oke? k he? ai =ma*  
 after 1PX 1PX/2PL-settle INTNS~all LOC TOP 1DEM =and  
 'After we all settled here and'
- (139) *reefk ii nasnaas te*  
 2.08 *reefk=ii na-snaas =te*  
*refek=ii na-snasa =SUB*  
*landslide=1DET 3-stop =SUB*  
 'when the landslide stopped,'
- (140) *He' au tata' he' au feot kou' gui, es he' maam Ros,*  
 2.11 *ahh he? au tata? he? au feot koo?gw=ii es he? maam Ros*  
*he? au tata? he? au feto ko?u=ii es he? maam Ros*  
 TOP 1SG eSi REL 1SG mS\M big=1DET COP REL mum\M Ros  
 'my older sibling who is the eldest daughter, which is mother Ros'
- (141) *hin nok hin aanr ini, sin natuan nabaarn ek hai uim ji ese' ai.*  
 2.15 *hiin n-ook hiin aan-r=ini siin na-tua=n na-baar=n ek hai*  
*hini n-oka hini ana-r=ini sini na-tua=n na-bara=n ek hai*  
 3SG 3-with 3SG child-3PSR;PL.PSM=PL 3PL 3-settle=PL 3-stay=PL LOC 1PX  
*uumɔ̄=ii ese? ai*  
*umi=ii esa he? ai*  
 house=1DET COP REL 1DEM  
 'she and her children have stayed living at our house which is here.'

C Selected Amarasí texts

- (142) *Tetapi hai bian ii hai mfain ek he' ruan he' reefk ee hin naann ee.*  
 2.19 *tetapi hai bian=ii hai m-fain ek he? ruan he? reefk=ee*  
*tetapi hai bian=ii hai m-fani ek he? ruan he? refek=ee*  
 but 1PX other=1DET 1PX 1PX/2-return LOC TOP village REL landslide=3DET  
*hiin naan-n=ee*  
*hini nana-n=ee*  
 3SG inside-3PSR;SG.PSM=3DET  
 'But we others we went back to the village which the landslide was in.'  
 (*lit.* village where the landslide's inside was)
- (143) *Tetapi setelah hai mfain te reefk ii reko.*  
 2.27 *tetapi setela hai m-fain =t reefk=ii reko*  
*tetapi setela hai m-fani =te refek=ii reko*  
 but after 1PX 1PX/2-return =SUB landslide=1DET good  
 'But after we went back the landslide was fine.' (i.e. it no longer a problem)
- 2.30 [While recording another man arrived, said *syalom* 'greetings' and approached us to shake hands. At 2.38 he said again *syalom bapa* 'greetings dad' and shook hands with the narrator (Gatmel Bana'), Melinaus Obhetan, and myself. The narrator was a little distracted until about 2.45 due to this.]
- (144) *Enai ma au bapa he' nahoni' kai ji,*  
 2.32 *enai =ma au bapa he? na-honi? =kaadz=ii*  
*enai =ma au bapa he? na-honi? =kai=ii*  
 and.so 1SG dad REL 3-birth =1PX.ACC=1DET  
 'And so my dad (at the time) which he had us,'
- (145) *hai tuaf bo' es am niim.*  
 2.37 *hai tuaf bo? esa =m niim*  
*hai tuaf bo? esa =ma nima*  
 1PX person ten one =and five  
 'there were fifteen of us.' (*lit.* we people were fifteen)
- (146) *Bapa nahoni' kai hai tuaf bo' es am niim.*  
 2.40 *bapa na-honi? =kai hai tuaf bo? esa =m niim*  
 dad 3-birth =1PX.ACC 1PX person ten one =and five  
 'Dad had fifteen of us.'



(147) *Enai te he' kamaets iin tuaf nua hen.*

2.45 *enai =te he? ka-maet-s=iin tuaf nua=heen*  
*enai =te he? ka-maet-s=ini tuaf nua=hena*  
 and.then REL NML-die-NML=PL person two=INCEP  
 'And then there are two which have died.'

(148) *Atoin' es ma bifee jes.*

2.48 *atoon?=ees =ma bifee?=?ees*  
*atoni?=esa =and bifee=esa*  
 man=one =and woman=one  
 'One man and one woman.'

(149) *Hai kamoint ii tuaf bo' es am teun.*

2.52 *hai ka-moin-t=ii tuaf bo? esa =m teun*  
*hai ka-moni-t=ii tuaf bo? esa =m tenu*  
 1PX NML-live-NML=1DET person ten one =and three  
 'There are thirteen of us are alive.'

(150) *Jadi, he' hai kamoint ii hai mtook mibaar ek nakaf Niin-Ri'in,*

2.55 *ɕɕadi he? hai ka-moin-t=ii hai m-took mi-baar ek*  
*ɕɕadi he? hai ka-moni-t=ii hai m-toko mi-bara ek*  
 so TOP 1PX NML-live-NML=1DET 1PX 1PX/2-sit 1PX/2PL-stay LOC  
*nakaf Niin-Ri'in*  
*nakaf Niin-Ri'in*  
 head-0GEN Niin-Ri'in

'So those of us who are alive, we stayed living at the head (top) of Niin-Ri'in.'

(151) *Tetapi au tata' maam Ros he' ai hin nfain neem ek hai ruan aa ese' nakaf Batuun he' ai*

3.02 *tetapi au tata? maam Ros he? ai hiin n-fain neem ek hai*  
*tetapi au tata? mama Ros he? ai hini n-fani nema ek hai*  
 but 1SG eSi mum\M Ros REL 1DEM 3SG 3-return 3\come LOC 1PX  
*ruan=aa ese? naka-f Batuun he? ai*  
*ruan=aa esa he? naka-f Batuna he? ai*  
 village=0DET COP REL head-0GEN Batuna REL 1DEM

'But my older sibling, mum Ros here, she came back to our village at the head (top) of Batuna which is here.'

C Selected Amarasi texts

(152) *Jadi fai ai hit t'oenn tabua ttoit Uisneno,*

3.11 *ɕɔadi fai ai hiit t'oenn ta-bua t-toit Uisneno*  
*ɕɔadi fai ai hiit t-ʔonen ta-bua t-toti Uisneno*  
 so night 1DEM 1PI 1PI-pray 1PI-gather 1PI-ask God  
 'So this evening we prayed together we asked God,'

(153) *nok Uisneno nmaneer nok kit.*

3.19 *n-ook Uisneno n-ma-neer n-ook =kiit*  
*n-oka Uisneno n-ma-nera n-oka =kiit*  
 3-with God 3-RECP-love 3-with =1PI.ACC  
 'that God would love/bless us'

(154) *Es hit mabe' ai te tabua,*

3.22 *ees hiit mabe? ai =t ta-bua*  
*esa hiit mabe? ai =te ta-bua*  
 COP 1PI evening 1DEM =SUB 1PI-gather  
 'It was this evening when we gathered,'

(155) *hai ori' es he' ho, ai' hai tata' es he' ho, mook paah Australia,*

3.25 *hai ori? ees he? hoo ai? hai tata? ese? hoo*  
*hai ori? esa he? hoo ai? hai tata? esa he? hoo*  
 1PX ySi COP REL 2SG or 1PX eSi COP REL 2SG  
*m-ook paah Australia*  
*m-oko paha Australia*  
 1PX/2-ABL land\M Australia

'(that) our younger brother, which is you, or our older brother which is you, (you are) from the land of Australia'

(156) *tetapi mabe' ai hit tateef tatuina' maneret Uisneno.*

3.28 *tetapi mabe? ai hiit ta-teef anene- ta-tuina?*  
*tetapi mabe? ai hiit ta-tefa ta-tuina?*  
 but evening 1DEM 1PI 1PI-meet 1PI-follow  
*ma-nere-t Uisneno*  
*ma-nera-t Uisneno*  
 RECP-love-NML God

'but this evening we have met based on the love of God'

(157) *Jadi peot he' au 'peo ek he' ai ji,*

3.34 *ɕɔadi peo-t he? au ?-peo k he? aɑɕʒ=ii*  
*ɕɔadi peo-t he? au ?-peo ek he? ai=ii*  
 so talk-NML REL 1SG 1SG-talk LOC REL 1DEM=1DET  
 'So the speech which I spoke here,'

(158) *hanya natuuk ma napaar, ntua ek he' ai*

3.37 *hapa na-tuuk =ma na-paar, n-tua k he? ai*  
*hapa na-tuka =ma na-para n-tua ek he? ai*  
 only 3-short =and 3-short 3-fill LOC TOP 1DEM  
 'it is only short [doublet], (it) finishes here.'

(159) *Au 'toit makasi.*

3.43 *au ?-toit makasi*  
*au ?-toti makasi*  
 1SG 1SG-ask thanks  
 'Thank you.'



## Appendix D: Text index

This appendix gives a list of all the Amarasi texts referenced in this book. It is arranged according to the chronological order in which the texts were recorded. Each text is headed by the unique code by which it is cross-referenced in example sentences in this book (see §1.5).

### D.1 Kotos texts

090524

|                    |                                                                                                                                                   |
|--------------------|---------------------------------------------------------------------------------------------------------------------------------------------------|
| Item name:         | aaz20090524                                                                                                                                       |
| Archive link:      | <a href="http://catalog.paradisec.org.au/collections/OE1/items/aaz20090524">http://catalog.paradisec.org.au/collections/OE1/items/aaz20090524</a> |
| Original name:     | aaz-20090524-Natoni-Nikah Massal-B                                                                                                                |
| Dialect:           | Kotos; Koro'oto hamlet                                                                                                                            |
| Location:          | Nekmese', Amarasi Selatan, Kupang                                                                                                                 |
| Date:              | 24/05/2009                                                                                                                                        |
| Speakers:          | Amarasi school children                                                                                                                           |
| Recorded by:       | Charles E. Grimes                                                                                                                                 |
| Transcribed by:    | Heronimus Bani, Charles E. Grimes, Yedida Ora                                                                                                     |
| Interlinear by:    | n./a.                                                                                                                                             |
| Indonesian/Kupang: | n./a.                                                                                                                                             |
| Free English by:   | Heronimus Bani, Charles E. Grimes, Yedida Ora                                                                                                     |
| Genre:             | poetry                                                                                                                                            |
| Summary:           | Traditional Amarasi chant performed by local children at the mass wedding service at the Ebenhaezer, Naimuti' church, Nekmese' village            |
| Notes:             | composed by Heronimus Bani, performed by Amarasi school children of Nekmese'                                                                      |

---

---

120715-0

|            |                |
|------------|----------------|
| Item name: | aaz20120715_00 |
|------------|----------------|

## D Text index

|                    |                                                                                                                                                                                                                         |
|--------------------|-------------------------------------------------------------------------------------------------------------------------------------------------------------------------------------------------------------------------|
| Archive link:      | <a href="http://catalog.paradisec.org.au/collections/OE1/items/aaz20120715_00">http://catalog.paradisec.org.au/collections/OE1/items/aaz20120715_00</a>                                                                 |
| Original name:     | aaz-20120715-0-Nekmese-Natoni-2                                                                                                                                                                                         |
| Dialect:           | Kotos; Koro'oto hamlet                                                                                                                                                                                                  |
| Location:          | Nekmese', Amarasi Selatan, Kupang                                                                                                                                                                                       |
| Date:              | 24/05/2009                                                                                                                                                                                                              |
| Speakers:          | Amarasi school children                                                                                                                                                                                                 |
| Recorded by:       | Daniel Kaufman, Katharine Gosling                                                                                                                                                                                       |
| Transcribed by:    | Heronimus Bani, Charles E. Grimes, Yedida Ora                                                                                                                                                                           |
| Interlinear by:    | n./a.                                                                                                                                                                                                                   |
| Indonesian/Kupang: | n./a.                                                                                                                                                                                                                   |
| Free English by:   | Charles E. Grimes, Yedida Ora                                                                                                                                                                                           |
| Genre:             | poetry                                                                                                                                                                                                                  |
| Summary:           | Traditional Amarasi chant performed by local children of Koro'oto, Nekmese', to welcome Dan Kaufman and participants from the July 2015 Language Documentation Workshop                                                 |
| Length:            |                                                                                                                                                                                                                         |
| Notes:             | Composed by Heronimus Bani, performed by Amarasi school children of Nekmese'                                                                                                                                            |
| Video:             | <a href="https://www.youtube.com/watch?v=TBqXhan5jl4&amp;list=PLcXFPx-z7B0q_2Ns3iYHigEY77DG4kXSU&amp;index=10">https://www.youtube.com/watch?v=TBqXhan5jl4&amp;list=PLcXFPx-z7B0q_2Ns3iYHigEY77DG4kXSU&amp;index=10</a> |

---

120715-1

|                    |                                                                                                                                                         |
|--------------------|---------------------------------------------------------------------------------------------------------------------------------------------------------|
| Item name:         | aaz20120715_01                                                                                                                                          |
| Archive link:      | <a href="http://catalog.paradisec.org.au/collections/OE1/items/aaz20120715_01">http://catalog.paradisec.org.au/collections/OE1/items/aaz20120715_01</a> |
| Original name:     | aaz-20120715-1-Nekmese-Oma-1                                                                                                                            |
| Dialect:           | Kotos; Fo'asa' hamlet                                                                                                                                   |
| Location:          | Nekmese', Amarasi Selatan, Kupang                                                                                                                       |
| Date:              | 15/07/2015                                                                                                                                              |
| Speakers:          | Yedida Ora                                                                                                                                              |
| Recorded by:       | Daniel Kaufman, Katharine Gosling                                                                                                                       |
| Transcribed by:    | Yedida Ora                                                                                                                                              |
| Interlinear by:    | Owen Edwards                                                                                                                                            |
| Indonesian/Kupang: | Yedida Ora                                                                                                                                              |
| Free English by:   | Owen Edwards                                                                                                                                            |
| Genre:             | narrative                                                                                                                                               |

|          |                                                                                                                                                                                                                         |
|----------|-------------------------------------------------------------------------------------------------------------------------------------------------------------------------------------------------------------------------|
| Summary: | Yedida Ora introduces herself and gives a short history of Nekmese' village                                                                                                                                             |
| Length:  | 1.40                                                                                                                                                                                                                    |
| Notes:   |                                                                                                                                                                                                                         |
| Video:   | <a href="https://www.youtube.com/watch?v=MwyNRkl1nBE&amp;list=PLcXFPx-z7B0q_2Ns3iYHigEY77DG4kXSU&amp;index=13">https://www.youtube.com/watch?v=MwyNRkl1nBE&amp;list=PLcXFPx-z7B0q_2Ns3iYHigEY77DG4kXSU&amp;index=13</a> |

120715-2

|                    |                                                                                                                                                                                                                         |
|--------------------|-------------------------------------------------------------------------------------------------------------------------------------------------------------------------------------------------------------------------|
| Item name:         | aaz20120715_02                                                                                                                                                                                                          |
| Archive link:      | <a href="http://catalog.paradisec.org.au/collections/OE1/items/aaz20120715_02">http://catalog.paradisec.org.au/collections/OE1/items/aaz20120715_02</a>                                                                 |
| Original name:     | aaz-20120715-2-Nekmese-Oma-2                                                                                                                                                                                            |
| Dialect:           | Kotos; Fo'asa' hamlet                                                                                                                                                                                                   |
| Location:          | Nekmese', Amarasi Selatan, Kupang                                                                                                                                                                                       |
| Date:              | 15/07/2015                                                                                                                                                                                                              |
| Speakers:          | Yedida Ora                                                                                                                                                                                                              |
| Recorded by:       | Daniel Kaufman, Katharine Gosling                                                                                                                                                                                       |
| Transcribed by:    | Yedida Ora                                                                                                                                                                                                              |
| Interlinear by:    | Owen Edwards                                                                                                                                                                                                            |
| Indonesian/Kupang: | Yedida Ora                                                                                                                                                                                                              |
| Free English by:   | Owen Edwards                                                                                                                                                                                                            |
| Genre:             | procedural                                                                                                                                                                                                              |
| Summary:           | explanation about how the villagers of Nekmese' farm                                                                                                                                                                    |
| Length:            | 1.39                                                                                                                                                                                                                    |
| video online       | <a href="https://www.youtube.com/watch?v=NnjAlncqyV4&amp;index=12&amp;list=PLcXFPx-z7B0q_2Ns3iYHigEY77DG4kXSU">https://www.youtube.com/watch?v=NnjAlncqyV4&amp;index=12&amp;list=PLcXFPx-z7B0q_2Ns3iYHigEY77DG4kXSU</a> |

120715-3

|                |                                                                                                                                                         |
|----------------|---------------------------------------------------------------------------------------------------------------------------------------------------------|
| Item name:     | aaz20120715_03                                                                                                                                          |
| Archive link:  | <a href="http://catalog.paradisec.org.au/collections/OE1/items/aaz20120715_03">http://catalog.paradisec.org.au/collections/OE1/items/aaz20120715_03</a> |
| Original name: | aaz-20120715-3-Nekmese-KusnawiBani-1                                                                                                                    |
| Dialect:       | Kotos; Koro'oto hamlet                                                                                                                                  |
| Location:      | Nekmese', Amarasi Selatan, Kupang                                                                                                                       |
| Date:          | 15/07/2015                                                                                                                                              |
| Speakers:      | Taniel Feni, Kusnawi Bani                                                                                                                               |

## D Text index

|                    |                                                                                                                                                                                                                         |
|--------------------|-------------------------------------------------------------------------------------------------------------------------------------------------------------------------------------------------------------------------|
| Recorded by:       | Daniel Kaufman, Heronimus Bani                                                                                                                                                                                          |
| Transcribed by:    | Yedida Ora                                                                                                                                                                                                              |
| Interlinear by:    | Owen Edwards                                                                                                                                                                                                            |
| Indonesian/Kupang: | Yedida Ora                                                                                                                                                                                                              |
| Free English by:   | Owen Edwards                                                                                                                                                                                                            |
| Genre:             | folk-tale                                                                                                                                                                                                               |
| Summary:           | a folk-tale about people who live on the moon                                                                                                                                                                           |
| Length:            | 1.28                                                                                                                                                                                                                    |
| Video:             | <a href="https://www.youtube.com/watch?v=H33aViriqy4&amp;index=14&amp;list=PLcXFPx-z7B0q_2Ns3iYHigEY77DG4kXSU">https://www.youtube.com/watch?v=H33aViriqy4&amp;index=14&amp;list=PLcXFPx-z7B0q_2Ns3iYHigEY77DG4kXSU</a> |

120715-4

|                    |                                                                                                                                                                                                                                                                                                                                                                                                                |
|--------------------|----------------------------------------------------------------------------------------------------------------------------------------------------------------------------------------------------------------------------------------------------------------------------------------------------------------------------------------------------------------------------------------------------------------|
| Item name:         | aaz20120715_04                                                                                                                                                                                                                                                                                                                                                                                                 |
| Archive link:      | <a href="http://catalog.paradisec.org.au/collections/OE1/items/aaz20120715_04">http://catalog.paradisec.org.au/collections/OE1/items/aaz20120715_04</a>                                                                                                                                                                                                                                                        |
| Original name:     | aaz-20120715-4-Nekmese-KusnawiBani-2                                                                                                                                                                                                                                                                                                                                                                           |
| Dialect:           | Kotos; Koro'oto hamlet                                                                                                                                                                                                                                                                                                                                                                                         |
| Location:          | Nekmese', Amarasi Selatan, Kupang                                                                                                                                                                                                                                                                                                                                                                              |
| Date:              | 15/07/2015                                                                                                                                                                                                                                                                                                                                                                                                     |
| Speakers:          | Taniel Feni, Kusnawi Bani, (Heronimus Bani)                                                                                                                                                                                                                                                                                                                                                                    |
| Recorded by:       | Daniel Kaufman, Heronimus Bani                                                                                                                                                                                                                                                                                                                                                                                 |
| Transcribed by:    | Yedida Ora                                                                                                                                                                                                                                                                                                                                                                                                     |
| Interlinear by:    | Owen Edwards                                                                                                                                                                                                                                                                                                                                                                                                   |
| Indonesian/Kupang: | Yedida Ora                                                                                                                                                                                                                                                                                                                                                                                                     |
| Free English by:   | Owen Edwards                                                                                                                                                                                                                                                                                                                                                                                                   |
| Genre:             | folk-tale                                                                                                                                                                                                                                                                                                                                                                                                      |
| Summary:           | a series of folk-tales:<br>1. Moo'-hitu: a mythical snake who created the world (0.00–3.03)<br>2. Brao stones: explanation of the source of a landscape feature (3.03–4.23)<br>3. Nii Obe': the king of Koro'oto (4.26–5.19)<br>4. How the village of Koro'oto got its name (5.27–6.30)<br>6. How the village of Ansaof got its name (6.34–7.33)<br>7. How the village of Kiu Mabanat got its name (7.35–8.11) |
| Length:            | 8.33                                                                                                                                                                                                                                                                                                                                                                                                           |



Video: [https://www.youtube.com/watch?v=Z\\_2D9WhYuuM&list=PLcXFPx-z7B0q\\_2Ns3iYHigEY77DG4kXSU&index=15](https://www.youtube.com/watch?v=Z_2D9WhYuuM&list=PLcXFPx-z7B0q_2Ns3iYHigEY77DG4kXSU&index=15)

|                    |                                                                                                                                                                                                     |
|--------------------|-----------------------------------------------------------------------------------------------------------------------------------------------------------------------------------------------------|
| 120923-1           |                                                                                                                                                                                                     |
| Item name:         | aaz20120923_01                                                                                                                                                                                      |
| Archive link:      | <a href="http://catalog.paradisec.org.au/collections/OE1/items/aaz20120923_01">http://catalog.paradisec.org.au/collections/OE1/items/aaz20120923_01</a>                                             |
| Original name:     | aaz-20120923-1-MelkiasMnao-Nekmese-biku                                                                                                                                                             |
| Dialect:           | Kotos; Koro'oto hamlet                                                                                                                                                                              |
| Location:          | Nekmese', Amarasi Selatan, Kupang                                                                                                                                                                   |
| Date:              | 23/09/2012                                                                                                                                                                                          |
| Speakers:          | Melkias Mna'o, (Heronimus Bani)                                                                                                                                                                     |
| Recorded by:       | Heronimus Bani                                                                                                                                                                                      |
| Transcribed by:    | Heronimus Bani                                                                                                                                                                                      |
| Interlinear by:    | Owen Edwards                                                                                                                                                                                        |
| Indonesian/Kupang: | n./a.                                                                                                                                                                                               |
| Free English by:   | Owen Edwards                                                                                                                                                                                        |
| Genre:             | narrative                                                                                                                                                                                           |
| Summary:           | Melkias tells Roni about a time someone cast the <i>biku</i> curse. He does so to discourage others from doing likewise. He also partially explains the method by which it is cast after Roni asks. |
| Length:            | 13.14                                                                                                                                                                                               |
| Notes:             | Melkias Mna'o has lived in Binoni-Aufme'e hamlet (village Oenoni 2) for quite some time                                                                                                             |

|                 |                                                                                                                                                         |
|-----------------|---------------------------------------------------------------------------------------------------------------------------------------------------------|
| 120923-2        |                                                                                                                                                         |
| Item name:      | aaz20120923_02                                                                                                                                          |
| Archive link:   | <a href="http://catalog.paradisec.org.au/collections/OE1/items/aaz20120923_02">http://catalog.paradisec.org.au/collections/OE1/items/aaz20120923_02</a> |
| Original name:  | aaz-20120923-2-MelkiasMnao-Nekmese-bunu                                                                                                                 |
| Dialect:        | Kotos; Koro'oto hamlet                                                                                                                                  |
| Location:       | Nekmese', Amarasi Selatan, Kupang                                                                                                                       |
| Date:           | 23/09/2012                                                                                                                                              |
| Speakers:       | Melkias Mna'o, (Heronimus Bani)                                                                                                                         |
| Recorded by:    | Heronimus Bani                                                                                                                                          |
| Transcribed by: | Heronimus Bani                                                                                                                                          |
| Interlinear by: | Owen Edwards                                                                                                                                            |

## D Text index

|                    |                                                                                             |
|--------------------|---------------------------------------------------------------------------------------------|
| Indonesian/Kupang: | Heronimus Bani                                                                              |
| Free English by:   | Owen Edwards                                                                                |
| Genre:             | procedural                                                                                  |
| Summary:           | Melkias Mna'o explains how one can use <i>bunu</i> to protect their crops from being stolen |
| Length:            | 7.05                                                                                        |
| Notes:             | Melkias Mna'o has lived in Binoni-Aufme'e hamlet (village Oenoni 2) for quite some time     |

---

|                    |                                                                                                                                                                                                            |
|--------------------|------------------------------------------------------------------------------------------------------------------------------------------------------------------------------------------------------------|
| 130821-1           |                                                                                                                                                                                                            |
| Item name:         | aaz20130821_01                                                                                                                                                                                             |
| Archive link:      | <a href="http://catalog.paradisec.org.au/collections/OE1/items/aaz20130821_01">http://catalog.paradisec.org.au/collections/OE1/items/aaz20130821_01</a>                                                    |
| Original name:     | aaz-20130821-1-Nekmese-Funeral                                                                                                                                                                             |
| Dialect:           | Kotos; Koro'oto hamlet                                                                                                                                                                                     |
| Location:          | Nekmese', Amarasi Selatan, Kupang                                                                                                                                                                          |
| Date:              | 21/08/2013                                                                                                                                                                                                 |
| Speakers:          | Heronimus Bani                                                                                                                                                                                             |
| Recorded by:       | Owen Edwards                                                                                                                                                                                               |
| Transcribed by:    | Heronimus Bani                                                                                                                                                                                             |
| Interlinear by:    | Owen Edwards                                                                                                                                                                                               |
| Indonesian/Kupang: | Heronimus Bani                                                                                                                                                                                             |
| Free English by:   | Owen Edwards                                                                                                                                                                                               |
| Genre:             | narrative                                                                                                                                                                                                  |
| Summary:           | 1. Heronimus Bani explains to an audience that Owen Edwards has come to stay in Nekmese' village to learn Amarasi<br>2. Heronimus Bani gives the genealogy of his recently deceased maternal aunt, Sarlina |
| Length:            | 10.10                                                                                                                                                                                                      |

---

|                |                                                                                                                                                         |
|----------------|---------------------------------------------------------------------------------------------------------------------------------------------------------|
| 130822-1       |                                                                                                                                                         |
| Item name:     | aaz20130822_01                                                                                                                                          |
| Archive link:  | <a href="http://catalog.paradisec.org.au/collections/OE1/items/aaz20130822_01">http://catalog.paradisec.org.au/collections/OE1/items/aaz20130822_01</a> |
| Original name: | aaz-20130822-1-HeronimusBani-Kuareno                                                                                                                    |
| Dialect:       | Kotos; Koro'oto hamlet                                                                                                                                  |
| Location:      | Nekmese', Amarasi Selatan, Kupang                                                                                                                       |
| Date:          | 22/08/2013                                                                                                                                              |

|                    |                                                      |
|--------------------|------------------------------------------------------|
| Speakers:          | Heronimus Bani                                       |
| Recorded by:       | Owen Edwards                                         |
| Transcribed by:    | Yedida Ora                                           |
| Interlinear by:    | Owen Edwards                                         |
| Indonesian/Kupang: | n/a.                                                 |
| Free English by:   | Owen Edwards                                         |
| Genre:             | narrative                                            |
| Summary:           | explanation of how the village Kuareno' got its name |
| Length:            | 0.41                                                 |
| Notes:             |                                                      |

---



---

|                    |                                                                                                                                                         |
|--------------------|---------------------------------------------------------------------------------------------------------------------------------------------------------|
| 130823-2           |                                                                                                                                                         |
| Item name:         | aaz20130823_02                                                                                                                                          |
| Archive link:      | <a href="http://catalog.paradisec.org.au/collections/OE1/items/aaz20130823_02">http://catalog.paradisec.org.au/collections/OE1/items/aaz20130823_02</a> |
| Original name:     | aaz-20130823-2-YurmemisOra-Kuareno                                                                                                                      |
| Dialect:           | Kotos; Koro'oto hamlet                                                                                                                                  |
| Location:          | Nekmese', Amarasi Selatan, Kupang                                                                                                                       |
| Date:              | 23/08/2013                                                                                                                                              |
| Speakers:          | Yurmemis Ora                                                                                                                                            |
| Recorded by:       | Owen Edwards                                                                                                                                            |
| Transcribed by:    | Yedida Ora, Heronimus Bani                                                                                                                              |
| Interlinear by:    | Owen Edwards                                                                                                                                            |
| Indonesian/Kupang: | Heronimus Bani                                                                                                                                          |
| Free English by:   | Owen Edwards                                                                                                                                            |
| Genre:             | narrative                                                                                                                                               |
| Summary:           | explanation of how the village Kuareno' got its name                                                                                                    |
| Length:            | 1.15                                                                                                                                                    |

---



---

|                |                                                                                                                                                         |
|----------------|---------------------------------------------------------------------------------------------------------------------------------------------------------|
| 130823-5       |                                                                                                                                                         |
| Item name:     | aaz20130823_05                                                                                                                                          |
| Archive link:  | <a href="http://catalog.paradisec.org.au/collections/OE1/items/aaz20130823_05">http://catalog.paradisec.org.au/collections/OE1/items/aaz20130823_05</a> |
| Original name: | aaz-20130823-5-EliotNubatonis                                                                                                                           |
| Dialect:       | Kotos; Koro'oto hamlet                                                                                                                                  |
| Location:      | Nekmese', Amarasi Selatan, Kupang                                                                                                                       |
| Date:          | 23/08/2013                                                                                                                                              |
| Speakers:      | Eliot Nubatonis                                                                                                                                         |
| Recorded by:   | Owen Edwards                                                                                                                                            |

## D Text index

|                    |                                  |
|--------------------|----------------------------------|
| Transcribed by:    | Yedida Ora                       |
| Interlinear by:    | Owen Edwards                     |
| Indonesian/Kupang: | n./a.                            |
| Free English by:   | Owen Edwards                     |
| Genre:             | auction                          |
| Summary:           | an auction of some rice and pork |
| Length:            | 1.23                             |

---

130823-8

|                    |                                                                                                                                                         |
|--------------------|---------------------------------------------------------------------------------------------------------------------------------------------------------|
| Item name:         | aaz20130823_08                                                                                                                                          |
| Archive link:      | <a href="http://catalog.paradisec.org.au/collections/OE1/items/aaz20130823_08">http://catalog.paradisec.org.au/collections/OE1/items/aaz20130823_08</a> |
| Original name:     | aaz-20130823-8-menangis                                                                                                                                 |
| Dialect:           | Kotos; Naet hamlet                                                                                                                                      |
| Location:          | Nekmese', Amarasi Selatan, Kupang                                                                                                                       |
| Date:              | 23/08/2013                                                                                                                                              |
| Recorded by:       | Owen Edwards                                                                                                                                            |
| Transcribed by:    | Yedida Ora                                                                                                                                              |
| Interlinear by:    | Owen Edwards                                                                                                                                            |
| Indonesian/Kupang: | Heronimus Bani                                                                                                                                          |
| Free English by:   | Owen Edwards                                                                                                                                            |
| Genre:             | mourning                                                                                                                                                |
| Summary:           | a woman mourns for her recently deceased grandmother                                                                                                    |
| Length:            | 9.45                                                                                                                                                    |

---

130823-9

|                    |                                                                                                                                                         |
|--------------------|---------------------------------------------------------------------------------------------------------------------------------------------------------|
| Item name:         | aaz20130823_09                                                                                                                                          |
| Archive link:      | <a href="http://catalog.paradisec.org.au/collections/OE1/items/aaz20130823_09">http://catalog.paradisec.org.au/collections/OE1/items/aaz20130823_09</a> |
| Original name:     | aaz-20130823-9-GersonNee                                                                                                                                |
| Dialect:           | Kotos; Koro'oto hamlet                                                                                                                                  |
| Location:          | Nekmese', Amarasi Selatan, Kupang                                                                                                                       |
| Date:              | 23/08/2013                                                                                                                                              |
| Speakers:          | Gerson Nee                                                                                                                                              |
| Recorded by:       | Owen Edwards                                                                                                                                            |
| Transcribed by:    | Yedida Ora                                                                                                                                              |
| Interlinear by:    | Owen Edwards                                                                                                                                            |
| Indonesian/Kupang: | Heronimus Bani                                                                                                                                          |

|                    |                                                                                                                                                         |
|--------------------|---------------------------------------------------------------------------------------------------------------------------------------------------------|
| Free English by:   | Owen Edwards                                                                                                                                            |
| Genre:             | narrative                                                                                                                                               |
| Summary:           | how the hamlet of Naet got its name                                                                                                                     |
| Length:            | 0.43                                                                                                                                                    |
| <hr/>              |                                                                                                                                                         |
| 130825-3           |                                                                                                                                                         |
| Item name:         | aaz20130825_03                                                                                                                                          |
| Archive link:      | <a href="http://catalog.paradisec.org.au/collections/OE1/items/aaz20130825_03">http://catalog.paradisec.org.au/collections/OE1/items/aaz20130825_03</a> |
| Original name:     | aaz-20130825-3-LukasOra-Nekmese                                                                                                                         |
| Dialect:           | Kotos; Koro'oto hamlet                                                                                                                                  |
| Location:          | Nekmese', Amarasi Selatan, Kupang                                                                                                                       |
| Date:              | 25/08/2013                                                                                                                                              |
| Speakers:          | Lukas Ora                                                                                                                                               |
| Recorded by:       | Heronimus Bani                                                                                                                                          |
| Transcribed by:    | Heronimus Bani                                                                                                                                          |
| Interlinear by:    | Owen Edwards                                                                                                                                            |
| Indonesian/Kupang: | Heronimus Bani                                                                                                                                          |
| Free English by:   | Owen Edwards                                                                                                                                            |
| Genre:             | poetry                                                                                                                                                  |
| Summary:           | greeting for new government officials                                                                                                                   |
| Length:            | 2.54                                                                                                                                                    |
| Notes:             | high wind and feedback from the loudspeaker reduce recording quality                                                                                    |
| <hr/>              |                                                                                                                                                         |
| 130825-6           |                                                                                                                                                         |
| Item name:         | aaz20130825_06                                                                                                                                          |
| Archive link:      | <a href="http://catalog.paradisec.org.au/collections/OE1/items/aaz20130825_06">http://catalog.paradisec.org.au/collections/OE1/items/aaz20130825_06</a> |
| Original name:     | aaz-20130825-6-JonathanNamah-1                                                                                                                          |
| Dialect:           | Kotos; Koro'oto hamlet                                                                                                                                  |
| Location:          | Nekmese', Amarasi Selatan, Kupang                                                                                                                       |
| Date:              | 25/08/2013                                                                                                                                              |
| Speakers:          | Jonathan Namah, Heronimus Bani, several others interrupt                                                                                                |
| Recorded by:       | Heronimus Bani                                                                                                                                          |
| Transcribed by:    | Heronimus Bani                                                                                                                                          |
| Interlinear by:    | Owen Edwards                                                                                                                                            |
| Indonesian/Kupang: | Heronimus Bani                                                                                                                                          |

## D Text index

|                  |                                                                                                                                          |
|------------------|------------------------------------------------------------------------------------------------------------------------------------------|
| Free English by: | Owen Edwards (only first seven minutes)                                                                                                  |
| Genre:           | narrative, (conversation)                                                                                                                |
| Summary:         | 1. story about Church (0.00-5.46)<br>2. story about the time Jonathan went to Jakarta, up until the time he was on the plane from Kupang |
| Length:          | 23.10                                                                                                                                    |
| Notes:           | continued as 130825-7 (see below)<br>loud background music and people often interrupt/talk over Jonathan.                                |

---

130825-7

|                    |                                                                                                                                                         |
|--------------------|---------------------------------------------------------------------------------------------------------------------------------------------------------|
| Item name:         | aaz20130825_07                                                                                                                                          |
| Archive link:      | <a href="http://catalog.paradisec.org.au/collections/OE1/items/aaz20130825_07">http://catalog.paradisec.org.au/collections/OE1/items/aaz20130825_07</a> |
| Original name:     | aaz-20130825-7-JonathanNamah-2                                                                                                                          |
| Dialect:           | Kotos; Koro'oto hamlet                                                                                                                                  |
| Location:          | Nekmese', Amarasi Selatan, Kupang                                                                                                                       |
| Date:              | 25/08/2013                                                                                                                                              |
| Speakers:          | Jonathan Namah, Heronimus Bani, several others interrupt                                                                                                |
| Recorded by:       | Heronimus Bani                                                                                                                                          |
| Transcribed by:    | Heronimus Bani                                                                                                                                          |
| Interlinear by:    | Owen Edwards                                                                                                                                            |
| Indonesian/Kupang: | Heronimus Bani                                                                                                                                          |
| Free English by:   | Owen Edwards                                                                                                                                            |
| Genre:             | narrative                                                                                                                                               |
| Summary:           | Jonathan relates his experience in the hotel in Jakarta                                                                                                 |
| Length:            | 4.01                                                                                                                                                    |
| Notes:             | continuation of 130825-6 above,<br>loud background music and people often interrupt/talk over Jonathan.                                                 |

---

130825-8

|                |                                                                                                                                                         |
|----------------|---------------------------------------------------------------------------------------------------------------------------------------------------------|
| Item name:     | aaz20130825_08                                                                                                                                          |
| Archive link:  | <a href="http://catalog.paradisec.org.au/collections/OE1/items/aaz20130825_08">http://catalog.paradisec.org.au/collections/OE1/items/aaz20130825_08</a> |
| Original name: | aaz-20130825-8-JonathanNamah-3                                                                                                                          |
| Dialect:       | Kotos; Koro'oto hamlet                                                                                                                                  |
| Location:      | Nekmese', Amarasi Selatan, Kupang                                                                                                                       |

|                    |                                                                                                         |
|--------------------|---------------------------------------------------------------------------------------------------------|
| Date:              | 25/08/2013                                                                                              |
| Speakers:          | Jonathan Namah, Heronimus Bani, several others interrupt                                                |
| Recorded by:       | Heronimus Bani                                                                                          |
| Transcribed by:    | Heronimus Bani                                                                                          |
| Interlinear by:    | Owen Edwards                                                                                            |
| Indonesian/Kupang: | Heronimus Bani                                                                                          |
| Free English by:   | Owen Edwards                                                                                            |
| Genre:             | narrative                                                                                               |
| Summary:           | Jonathan relates his experience in the hotel in Jakarta                                                 |
| Length:            | 2.20                                                                                                    |
| Notes:             | continuation of 130825-7 above,<br>loud background music and people often interrupt/talk over Jonathan. |

130902 - 1

|                    |                                                                                                                                                         |
|--------------------|---------------------------------------------------------------------------------------------------------------------------------------------------------|
| Item name:         | aaz20130902_01                                                                                                                                          |
| Archive link:      | <a href="http://catalog.paradisec.org.au/collections/OE1/items/aaz20130902_01">http://catalog.paradisec.org.au/collections/OE1/items/aaz20130902_01</a> |
| Original name:     | aaz-20130902-1-HeronimusBani-Cerita-JumatSenin                                                                                                          |
| Dialect:           | Kotos; Koro'oto hamlet                                                                                                                                  |
| Location:          | Nekmese', Amarasi Selatan, Kupang                                                                                                                       |
| Date:              | 02/09/2013                                                                                                                                              |
| Speakers:          | Heronimus Bani                                                                                                                                          |
| Recorded by:       | Heronimus Bani                                                                                                                                          |
| Transcribed by:    | Heronimus Bani                                                                                                                                          |
| Interlinear by:    | Owen Edwards                                                                                                                                            |
| Indonesian/Kupang: | Heronimus Bani                                                                                                                                          |
| Free English by:   | Owen Edwards                                                                                                                                            |
| Genre:             | narrative                                                                                                                                               |
| Summary:           | Heronimus Bani relates the things he and Owen Edwards did over the past few days                                                                        |
| Length:            | 4.38                                                                                                                                                    |

130902 - 7

|                |                                                                                                                                                         |
|----------------|---------------------------------------------------------------------------------------------------------------------------------------------------------|
| Item name:     | aaz20130902_07                                                                                                                                          |
| Archive link:  | <a href="http://catalog.paradisec.org.au/collections/OE1/items/aaz20130902_07">http://catalog.paradisec.org.au/collections/OE1/items/aaz20130902_07</a> |
| Original name: | aaz-20130902-7-HeronimusBani-IsakFeni-BahasaAdat                                                                                                        |

## D Text index

|                    |                                                       |
|--------------------|-------------------------------------------------------|
| Dialect:           | Kotos; Koro'to hamlet, Ro'is; Buraen village          |
| Location:          | Nekmese', Amarasi Selatan, Kupang                     |
| Date:              | 02/09/2013                                            |
| Speakers:          | Heronimus Bani (Kotos), Isak FenOwen Edwardsi (Ro'is) |
| Recorded by:       | Heronimus Bani                                        |
| Transcribed by:    | Heronimus Bani                                        |
| Interlinear by:    | Owen Edwards                                          |
| Indonesian/Kupang: | Heronimus Bani                                        |
| Free English by:   | Owen Edwards                                          |
| Genre:             | ritual speech                                         |
| Summary:           | formal conversation about marriage arrangements       |
| Length:            | 5.50                                                  |

---

130905-1

|                    |                                                                                                                                                         |
|--------------------|---------------------------------------------------------------------------------------------------------------------------------------------------------|
| Item name:         | aaz20130905_01                                                                                                                                          |
| Archive link:      | <a href="http://catalog.paradisec.org.au/collections/OE1/items/aaz20130905_01">http://catalog.paradisec.org.au/collections/OE1/items/aaz20130905_01</a> |
| Original name:     | aaz-20130905-1-HeronimusBani-arahan-pilkada-bupati-kupang                                                                                               |
| Dialect:           | Kotos; Koro'oto hamlet                                                                                                                                  |
| Location:          | Nekmese', Amarasi Selatan, Kupang                                                                                                                       |
| Date:              | 05/09/2013                                                                                                                                              |
| Speakers:          | Heronimus Bani                                                                                                                                          |
| Recorded by:       | Owen Edwards                                                                                                                                            |
| Transcribed by:    | Heronimus Bani                                                                                                                                          |
| Interlinear by:    | Owen Edwards                                                                                                                                            |
| Indonesian/Kupang: | Heronimus Bani                                                                                                                                          |
| Free English by:   | Owen Edwards                                                                                                                                            |
| Genre:             | procedural                                                                                                                                              |
| Summary:           | Heronimus Bani gives instructions on how to vote for the Kupang bupati (regent)                                                                         |
| Length:            | 1.47                                                                                                                                                    |
| Notes:             | recording starts part way through, entirety videoed                                                                                                     |

---

130906-1

|                |                                                                                                                                                         |
|----------------|---------------------------------------------------------------------------------------------------------------------------------------------------------|
| Item name:     | aaz20130906_01                                                                                                                                          |
| Archive link:  | <a href="http://catalog.paradisec.org.au/collections/OE1/items/aaz20130906_01">http://catalog.paradisec.org.au/collections/OE1/items/aaz20130906_01</a> |
| Original name: | aaz-20130906-1-JakopBani-percakapan                                                                                                                     |



|                    |                                         |
|--------------------|-----------------------------------------|
| Dialect:           | Kotos; Koro'oto hamlet                  |
| Location:          | Nekmese', Amarasi Selatan, Kupang       |
| Date:              | 06/09/2013                              |
| Speakers:          | Jakop Bani, Heronimus Bani, (Lena Bani) |
| Recorded by:       | Heronimus Bani                          |
| Transcribed by:    | Heronimus Bani                          |
| Interlinear by:    | Owen Edwards                            |
| Indonesian/Kupang: | Heronimus Bani                          |
| Free English by:   | Owen Edwards                            |
| Genre:             | conversation                            |
| Length:            | 6.11                                    |

130907 - 3

|                    |                                                                                                                                                         |
|--------------------|---------------------------------------------------------------------------------------------------------------------------------------------------------|
| Item name:         | aaz20130907_03                                                                                                                                          |
| Archive link:      | <a href="http://catalog.paradisec.org.au/collections/OE1/items/aaz20130907_03">http://catalog.paradisec.org.au/collections/OE1/items/aaz20130907_03</a> |
| Original name:     | aaz-20130907-3-FransBani-Cerita-1                                                                                                                       |
| Dialect:           | Kotos; Koro'oto hamlet                                                                                                                                  |
| Location:          | Nekmese', Amarasi Selatan, Kupang                                                                                                                       |
| Date:              | 07/09/2013                                                                                                                                              |
| Speakers:          | Frans Bani                                                                                                                                              |
| Recorded by:       | Heronimus Bani                                                                                                                                          |
| Transcribed by:    | Heronimus Bani                                                                                                                                          |
| Interlinear by:    | Owen Edwards Heronimus Bani                                                                                                                             |
| Indonesian/Kupang: | Heronimus Bani                                                                                                                                          |
| Free English by:   | Owen Edwards                                                                                                                                            |
| Genre:             | narrative                                                                                                                                               |
| Summary:           | Frans Bani (Roni's dad) tells his life story from the time he was at school up until the birth of his first child                                       |
| Length:            | 15.37                                                                                                                                                   |
| Notes:             | faint recording, people sifting rice loudly in background                                                                                               |

130907 - 4

|                |                                                                                                                                                         |
|----------------|---------------------------------------------------------------------------------------------------------------------------------------------------------|
| Item name:     | aaz20130907_04                                                                                                                                          |
| Archive link:  | <a href="http://catalog.paradisec.org.au/collections/OE1/items/aaz20130907_04">http://catalog.paradisec.org.au/collections/OE1/items/aaz20130907_04</a> |
| Original name: | aaz-20130907-4-FransBani-Cerita-2                                                                                                                       |

## D Text index

|                    |                                                           |
|--------------------|-----------------------------------------------------------|
| Dialect:           | Kotos; Koro'oto hamlet                                    |
| Location:          | Nekmese', Amarasi Selatan, Kupang                         |
| Date:              | 07/09/2013                                                |
| Speakers:          | Frans Bani                                                |
| Recorded by:       | Heronimus Bani                                            |
| Transcribed by:    | Heronimus Bani                                            |
| Interlinear by:    | Owen Edwards Heronimus Bani                               |
| Indonesian/Kupang: | Heronimus Bani                                            |
| Free English by:   | Owen Edwards                                              |
| Genre:             | narrative                                                 |
| Summary:           | Frans Bani talks about his children's schooling           |
| Length:            | 4.07                                                      |
| Notes:             | faint recording, people sifting rice loudly in background |

---

130907-4

|                    |                                                                                                                                                         |
|--------------------|---------------------------------------------------------------------------------------------------------------------------------------------------------|
| Item name:         | aaz20130907_05                                                                                                                                          |
| Archive link:      | <a href="http://catalog.paradisec.org.au/collections/OE1/items/aaz20130907_05">http://catalog.paradisec.org.au/collections/OE1/items/aaz20130907_05</a> |
| Original name:     | aaz-20130907-5-FransBani-Cerita-3                                                                                                                       |
| Dialect:           | Kotos; Koro'oto hamlet                                                                                                                                  |
| Location:          | Nekmese', Amarasi Selatan, Kupang                                                                                                                       |
| Date:              | 07/09/2013                                                                                                                                              |
| Speakers:          | Frans Bani                                                                                                                                              |
| Recorded by:       | Heronimus Bani                                                                                                                                          |
| Transcribed by:    | Heronimus Bani                                                                                                                                          |
| Interlinear by:    | Owen Edwards Heronimus Bani                                                                                                                             |
| Indonesian/Kupang: | Heronimus Bani                                                                                                                                          |
| Free English by:   | Owen Edwards                                                                                                                                            |
| Genre:             | narrative                                                                                                                                               |
| Summary:           | Frans Bani talks about working for the Church                                                                                                           |
| Length:            | 2.04                                                                                                                                                    |
| Notes:             | faint recording, people sifting rice loudly in background                                                                                               |

---

130909-5

|               |                                                                                                                                                         |
|---------------|---------------------------------------------------------------------------------------------------------------------------------------------------------|
| Item name:    | aaz20130909_05                                                                                                                                          |
| Archive link: | <a href="http://catalog.paradisec.org.au/collections/OE1/items/aaz20130909_05">http://catalog.paradisec.org.au/collections/OE1/items/aaz20130909_05</a> |

|                    |                                                                                                                                                         |
|--------------------|---------------------------------------------------------------------------------------------------------------------------------------------------------|
| Original name:     | aaz-20130909-5-AlfonsusTakain-OmongMasala-3                                                                                                             |
| Dialect:           | Kotos; Koro'oto hamlet                                                                                                                                  |
| Location:          | Nekmese', Amarasi Selatan, Kupang                                                                                                                       |
| Date:              | 09/09/2015                                                                                                                                              |
| Speakers:          | Alfonsus Takain                                                                                                                                         |
| Recorded by:       | Heronimus Bani                                                                                                                                          |
| Transcribed by:    | Heronimus Bani                                                                                                                                          |
| Interlinear by:    | Owen Edwards                                                                                                                                            |
| Indonesian/Kupang: | Heronimus Bani                                                                                                                                          |
| Free English by:   | Owen Edwards                                                                                                                                            |
| Genre:             | narrative                                                                                                                                               |
| Summary:           | Alfonsus relates a mistake made in the counting and collection of Church offertories                                                                    |
| Length:            | 1.10                                                                                                                                                    |
| <hr/>              |                                                                                                                                                         |
| 130909-6           |                                                                                                                                                         |
| Item name:         | aaz20130909_06                                                                                                                                          |
| Archive link:      | <a href="http://catalog.paradisec.org.au/collections/OE1/items/aaz20130909_06">http://catalog.paradisec.org.au/collections/OE1/items/aaz20130909_06</a> |
| Original name:     | aaz-20130909-6-ObetBani-CeritaKeluargaDiRumah                                                                                                           |
| Dialect:           | Kotos; Koro'oto hamlet                                                                                                                                  |
| Location:          | Nekmese', Amarasi Selatan, Kupang                                                                                                                       |
| Date:              | 09/09/2013                                                                                                                                              |
| Speakers:          | Heronimus Bani, Obet Bani, Ema Bani,                                                                                                                    |
| Recorded by:       | Heronimus Bani                                                                                                                                          |
| Transcribed by:    | Heronimus Bani                                                                                                                                          |
| Interlinear by:    | Owen Edwards                                                                                                                                            |
| Indonesian/Kupang: | Heronimus Bani                                                                                                                                          |
| Free English by:   | Owen Edwards                                                                                                                                            |
| Genre:             | conversation                                                                                                                                            |
| Summary:           | conversation about Obet's life at home without his children (who are working elsewhere)                                                                 |
| Length:            | 4.14                                                                                                                                                    |
| <hr/>              |                                                                                                                                                         |
| 130911-2           |                                                                                                                                                         |
| Item name:         | aaz20130911_02                                                                                                                                          |
| Archive link:      | <a href="http://catalog.paradisec.org.au/collections/OE1/items/aaz20130911_02">http://catalog.paradisec.org.au/collections/OE1/items/aaz20130911_02</a> |
| Original name:     | aaz-20130911-2-DominggusBani-HenkiOra-CeritaOtoJato                                                                                                     |

## D Text index

|                    |                                                                           |
|--------------------|---------------------------------------------------------------------------|
| Dialect:           | Kotos; Koro'oto hamlet                                                    |
| Location:          | Nekmese', Amarasi Selatan, Kupang                                         |
| Date:              | 11/09/2013                                                                |
| Speakers:          | Dominggus Bani, Heronimus Bani, Sefnat Bois, Henki Ora, occasional others |
| Recorded by:       | Heronimus Bani                                                            |
| Transcribed by:    | Heronimus Bani                                                            |
| Interlinear by:    | Owen Edwards                                                              |
| Indonesian/Kupang: | Heronimus Bani                                                            |
| Free English by:   | Owen Edwards                                                              |
| Genre:             | conversation                                                              |
| Summary:           | conversation about a car which crashed and came off the road              |
| Length:            | 1.43                                                                      |

---

---

130912

|                    |                                                                                                                                                   |
|--------------------|---------------------------------------------------------------------------------------------------------------------------------------------------|
| Item name:         | aaz20130912                                                                                                                                       |
| Archive link:      | <a href="http://catalog.paradisec.org.au/collections/OE1/items/aaz20130912">http://catalog.paradisec.org.au/collections/OE1/items/aaz20130912</a> |
| Original name:     | aaz-20130912-HeronimusBani-cerita-pulang-dari-orang-mati                                                                                          |
| Dialect:           | Kotos; Koro'oto hamlet                                                                                                                            |
| Location:          | Nekmese', Amarasi Selatan, Kupang                                                                                                                 |
| Date:              | 12/09/2013                                                                                                                                        |
| Speakers:          | Heronimus Bani, Rehuel Nakmofa, Sem Saebesi                                                                                                       |
| Recorded by:       | Heronimus Bani                                                                                                                                    |
| Transcribed by:    | Heronimus Bani                                                                                                                                    |
| Interlinear by:    | Owen Edwards                                                                                                                                      |
| Indonesian/Kupang: | Heronimus Bani                                                                                                                                    |
| Free English by:   | Owen Edwards                                                                                                                                      |
| Genre:             | conversation                                                                                                                                      |
| Summary:           | conversation about someone who recently died                                                                                                      |
| Length:            | 1.01                                                                                                                                              |

---

---

130913-1

|                |                                                                                                                                                         |
|----------------|---------------------------------------------------------------------------------------------------------------------------------------------------------|
| Item name:     | aaz20130913_01                                                                                                                                          |
| Archive link:  | <a href="http://catalog.paradisec.org.au/collections/OE1/items/aaz20130913_01">http://catalog.paradisec.org.au/collections/OE1/items/aaz20130913_01</a> |
| Original name: | aaz-20130913-1-ItkaNenoharan-MerpatiTakain-Cerita                                                                                                       |
| Dialect:       | Kotos; Koro'oto hamlet, Fo'asa' hamlet                                                                                                                  |

|                    |                                                                                                                                             |
|--------------------|---------------------------------------------------------------------------------------------------------------------------------------------|
| Location:          | Nekmese', Amarasi Selatan, Kupang                                                                                                           |
| Date:              | 13/09/2013                                                                                                                                  |
| Speakers:          | Heronimus Bani, Itka Nenoharan, Merpati Takain, Justus Mantolas                                                                             |
| Recorded by:       | Heronimus Bani                                                                                                                              |
| Transcribed by:    | Heronimus Bani                                                                                                                              |
| Interlinear by:    | Owen Edwards                                                                                                                                |
| Indonesian/Kupang: | Heronimus Bani                                                                                                                              |
| Free English by:   | Owen Edwards                                                                                                                                |
| Genre:             | conversation                                                                                                                                |
| Summary:           | a conversation about a man who has already made preparations for his funeral, even though he's still fit and healthy                        |
| Length:            | 3.03                                                                                                                                        |
| Notes:             | Itka Nenoharan is from Fo'asa', Justus Mantolas is originally from Amanatun. (Hence, the phoneme /l/.) He has lived in Nekmese' since 1981. |

130914 - 1

|                    |                                                                                                                                                         |
|--------------------|---------------------------------------------------------------------------------------------------------------------------------------------------------|
| Item name:         | aaz20130914_01                                                                                                                                          |
| Archive link:      | <a href="http://catalog.paradisec.org.au/collections/OE1/items/aaz20130914_01">http://catalog.paradisec.org.au/collections/OE1/items/aaz20130914_01</a> |
| Original name:     | aaz-20130914-1-MateldaBani-cerita-kerja-tenun                                                                                                           |
| Dialect:           | Kotos; Koro'oto hamlet                                                                                                                                  |
| Location:          | Nekmese', Amarasi Selatan, Kupang                                                                                                                       |
| Date:              | 14/09/2013                                                                                                                                              |
| Speakers:          | Metelda Bani, Heronimus Bani                                                                                                                            |
| Recorded by:       | Heronimus Bani                                                                                                                                          |
| Transcribed by:    | Heronimus Bani                                                                                                                                          |
| Interlinear by:    | Owen Edwards                                                                                                                                            |
| Indonesian/Kupang: | Heronimus Bani                                                                                                                                          |
| Free English by:   | Owen Edwards                                                                                                                                            |
| Genre:             | conversation                                                                                                                                            |
| Summary:           | conversation about how to weave                                                                                                                         |
| Length:            | 3.03                                                                                                                                                    |

130914 - 2

|            |                |
|------------|----------------|
| Item name: | aaz20130914_02 |
|------------|----------------|

## D Text index

|                    |                                                                                                                                                         |
|--------------------|---------------------------------------------------------------------------------------------------------------------------------------------------------|
| Archive link:      | <a href="http://catalog.paradisec.org.au/collections/OE1/items/aaz20130914_02">http://catalog.paradisec.org.au/collections/OE1/items/aaz20130914_02</a> |
| Original name:     | aaz-20130914-2-Regina-Sarai-Sarmolina-cerita-ternak-lepas                                                                                               |
| Dialect:           | Kotos; Koro'oto hamlet, Fo'asa' hamlet                                                                                                                  |
| Location:          | Nekmese', Amarasi Selatan, Kupang                                                                                                                       |
| Date:              | 14/09/2016                                                                                                                                              |
| Speakers:          | Regina, Sarai, Sarmolina                                                                                                                                |
| Recorded by:       | Heronimus Bani                                                                                                                                          |
| Transcribed by:    | Heronimus Bani                                                                                                                                          |
| Interlinear by:    | Owen Edwards                                                                                                                                            |
| Indonesian/Kupang: | Heronimus Bani                                                                                                                                          |
| Free English by:   | Owen Edwards                                                                                                                                            |
| Genre:             | conversation                                                                                                                                            |
| Summary:           | conversation about some pigs which escaped                                                                                                              |
| Length:            | 1.36                                                                                                                                                    |
| Notes:             | Regina is from Fo'asa' hamlet                                                                                                                           |

---

130914-3

|                    |                                                                                                                                                         |
|--------------------|---------------------------------------------------------------------------------------------------------------------------------------------------------|
| Item name:         | aaz20130914_03                                                                                                                                          |
| Archive link:      | <a href="http://catalog.paradisec.org.au/collections/OE1/items/aaz20130914_03">http://catalog.paradisec.org.au/collections/OE1/items/aaz20130914_03</a> |
| Original name:     | aaz-20130914-3-Sarmolina-Lena-cerita-jalan-pi-Sontraen                                                                                                  |
| Dialect:           | Kotos; Koro'oto hamlet                                                                                                                                  |
| Location:          | Nekmese', Amarasi Selatan, Kupang                                                                                                                       |
| Date:              | 14/09/2013                                                                                                                                              |
| Speakers:          | Sarmolina, Lena Bani, Regina                                                                                                                            |
| Recorded by:       | Heronimus Bani                                                                                                                                          |
| Transcribed by:    | Heronimus Bani                                                                                                                                          |
| Interlinear by:    | Owen Edwards                                                                                                                                            |
| Indonesian/Kupang: | Heronimus Bani                                                                                                                                          |
| Free English by:   | Owen Edwards                                                                                                                                            |
| Genre:             | conversation                                                                                                                                            |
| Summary:           | conversation about when Sarmolina went to Sonraen                                                                                                       |
| Length:            | 2.21                                                                                                                                                    |

---

130920-1

|               |                                                                                                                                                         |
|---------------|---------------------------------------------------------------------------------------------------------------------------------------------------------|
| Item name:    | aaz20130920_01                                                                                                                                          |
| Archive link: | <a href="http://catalog.paradisec.org.au/collections/OE1/items/aaz20130920_01">http://catalog.paradisec.org.au/collections/OE1/items/aaz20130920_01</a> |

|                    |                                                                                                                                                        |
|--------------------|--------------------------------------------------------------------------------------------------------------------------------------------------------|
| Original name:     | aaz-20130920-1-HeronimusBani-CeritaTtgFinalCheck                                                                                                       |
| Dialect:           | Kotos; Koro'oto hamlet                                                                                                                                 |
| Location:          | Kupang city                                                                                                                                            |
| Date:              | 20/09/2013                                                                                                                                             |
| Speakers:          | Heronimus Bani                                                                                                                                         |
| Recorded by:       | Owen Edwards                                                                                                                                           |
| Transcribed by:    | Heronimus Bani                                                                                                                                         |
| Interlinear by:    | Owen Edwards                                                                                                                                           |
| Indonesian/Kupang: | Heronimus Bani                                                                                                                                         |
| Free English by:   | Owen Edwards                                                                                                                                           |
| Genre:             | narrative                                                                                                                                              |
| Summary:           | Roni talks about his work over the past week proofreading books of the Bible and checking them for naturalness with a group of villagers from Nekmese' |
| Length:            | 5.17                                                                                                                                                   |
| Notes:             | recorded in studio for a high quality recording                                                                                                        |

130921-1

|                    |                                                                                                                                                         |
|--------------------|---------------------------------------------------------------------------------------------------------------------------------------------------------|
| Item name:         | aaz20130921_01                                                                                                                                          |
| Archive link:      | <a href="http://catalog.paradisec.org.au/collections/OE1/items/aaz20130921_01">http://catalog.paradisec.org.au/collections/OE1/items/aaz20130921_01</a> |
| Original name:     | aaz-20130921-1-YedidaOra-CeritaTtgFinalCheck                                                                                                            |
| Dialect:           | Kotos; Fo'asa' hamlet                                                                                                                                   |
| Location:          | Kupang city                                                                                                                                             |
| Date:              | 21/09/2013                                                                                                                                              |
| Speakers:          | Yedida Ora                                                                                                                                              |
| Recorded by:       | Owen Edwards                                                                                                                                            |
| Transcribed by:    | Yedida Ora                                                                                                                                              |
| Interlinear by:    | Owen Edwards                                                                                                                                            |
| Indonesian/Kupang: | Owen Edwards                                                                                                                                            |
| Free English by:   | Owen Edwards                                                                                                                                            |
| Genre:             | narrative                                                                                                                                               |
| Summary:           | Oma talks about her work over the past week proofreading books of the Bible and checking them for naturalness with a group of villagers from Nekmese'   |
| Length:            | 2.17                                                                                                                                                    |

## D Text index

|                    |                                                                                                                                                         |
|--------------------|---------------------------------------------------------------------------------------------------------------------------------------------------------|
| Notes:             | recorded in studio for a high quality recording                                                                                                         |
| <hr/>              |                                                                                                                                                         |
| 130925-1           |                                                                                                                                                         |
| Item name:         | aaz20130925_01                                                                                                                                          |
| Archive link:      | <a href="http://catalog.paradisec.org.au/collections/OE1/items/aaz20130925_01">http://catalog.paradisec.org.au/collections/OE1/items/aaz20130925_01</a> |
| Original name:     | aaz-20130925-1-AlbertBani-et-al-PencurianSapi                                                                                                           |
| Dialect:           | Kotos; Koro'oto hamlet                                                                                                                                  |
| Location:          | Nekmese', Amarasi Selatan, Kupang                                                                                                                       |
| Date:              | 25/09/2013                                                                                                                                              |
| Speakers:          | Albert Bani, Metheos Ora, Alfrid Bani, Heronimus Bani                                                                                                   |
| Recorded by:       | Heronimus Bani                                                                                                                                          |
| Transcribed by:    | Heronimus Bani                                                                                                                                          |
| Interlinear by:    | Owen Edwards                                                                                                                                            |
| Indonesian/Kupang: | Heronimus Bani                                                                                                                                          |
| Free English by:   | Owen Edwards                                                                                                                                            |
| Genre:             | conversation                                                                                                                                            |
| Summary:           | conversation about someone who was stealing cows                                                                                                        |
| Length:            | 4.50                                                                                                                                                    |
| <hr/>              |                                                                                                                                                         |
| 130926-1           |                                                                                                                                                         |
| Item name:         | aaz20130926_01                                                                                                                                          |
| Archive link:      | <a href="http://catalog.paradisec.org.au/collections/OE1/items/aaz20130926_01">http://catalog.paradisec.org.au/collections/OE1/items/aaz20130926_01</a> |
| Original name:     | aaz-20130926-1-RidolfNeno-OmonglisBelis                                                                                                                 |
| Dialect:           | Kotos; Koro'oto hamlet                                                                                                                                  |
| Location:          | Nekmese', Amarasi Selatan, Kupang                                                                                                                       |
| Date:              | 26/09/2013                                                                                                                                              |
| Speakers:          | Ridolf Neno, Heronimus Bani                                                                                                                             |
| Recorded by:       | Heronimus Bani                                                                                                                                          |
| Transcribed by:    | Heronimus Bani                                                                                                                                          |
| Interlinear by:    | Owen Edwards                                                                                                                                            |
| Indonesian/Kupang: | Heronimus Bani                                                                                                                                          |
| Free English by:   | Owen Edwards                                                                                                                                            |
| Genre:             | conversation                                                                                                                                            |
| Summary:           | Roni and Ridolf discuss bride-price arrangements                                                                                                        |
| Length:            | 4.20                                                                                                                                                    |



|                    |                                                                                                                                                         |
|--------------------|---------------------------------------------------------------------------------------------------------------------------------------------------------|
| Notes:             | final half minute not transcribed                                                                                                                       |
| <hr/>              |                                                                                                                                                         |
| 130928 - 1         |                                                                                                                                                         |
| Item name:         | aaz20130928_01                                                                                                                                          |
| Archive link:      | <a href="http://catalog.paradisec.org.au/collections/OE1/items/aaz20130928_01">http://catalog.paradisec.org.au/collections/OE1/items/aaz20130928_01</a> |
| Original name:     | aaz-20130928-1-HeronimusBani-CeritaNahorBaniMati                                                                                                        |
| Dialect:           | Kotos; Koro'oto hamlet                                                                                                                                  |
| Location:          | Nekmese', Amarasi Selatan, Kupang                                                                                                                       |
| Date:              | 28/09/2013                                                                                                                                              |
| Speakers:          | Heronimus Bani                                                                                                                                          |
| Recorded by:       | Heronimus Bani                                                                                                                                          |
| Transcribed by:    | Heronimus Bani                                                                                                                                          |
| Interlinear by:    | Owen Edwards                                                                                                                                            |
| Indonesian/Kupang: | Heronimus Bani                                                                                                                                          |
| Free English by:   | Charles E. Grimes                                                                                                                                       |
| Genre:             | narrative                                                                                                                                               |
| Summary:           | Roni relates a disagreement over where recently deceased Nahor Bani should be buried                                                                    |
| Length:            | 2.51                                                                                                                                                    |
| <hr/>              |                                                                                                                                                         |
| 140726             |                                                                                                                                                         |
| Item name:         | aaz20140726                                                                                                                                             |
| Archive link:      | <a href="http://catalog.paradisec.org.au/collections/OE1/items/aaz20140726">http://catalog.paradisec.org.au/collections/OE1/items/aaz20140726</a>       |
| Original name:     | aaz-20140726-A'asramat-Casuarina-UCA                                                                                                                    |
| Dialect:           | Kotos; Koro'oto hamlet, Fo'asa' hamlet                                                                                                                  |
| Location:          | Darwin, Northern Territory, Australia                                                                                                                   |
| Date:              | 26/07/2014                                                                                                                                              |
| Speakers:          | Yedida Ora, Heronimus Bani, Charles E. Grimes                                                                                                           |
| Recorded by:       | Charles E. Grimes                                                                                                                                       |
| Transcribed by:    | Heronimus Bani                                                                                                                                          |
| Interlinear by:    | Owen Edwards                                                                                                                                            |
| Indonesian/Kupang: | n./a.                                                                                                                                                   |
| Free English by:   | Charles E. Grimes                                                                                                                                       |
| Genre:             | poetry                                                                                                                                                  |
| Summary:           | Prayer for the people of Casuarina                                                                                                                      |
| Length:            | 1.00                                                                                                                                                    |

## D Text index

Notes: composed by Heronimus Bani, Performed by Yedida Ora (leader) Heronimus Bani and Charles Grimes

|                    |                                                                                                                                                   |
|--------------------|---------------------------------------------------------------------------------------------------------------------------------------------------|
| 160326             |                                                                                                                                                   |
| Item name:         | aaz20160326                                                                                                                                       |
| Archive link:      | <a href="http://catalog.paradisec.org.au/collections/OE1/items/aaz20160326">http://catalog.paradisec.org.au/collections/OE1/items/aaz20160326</a> |
| Original name:     | aaz-20160326-Roni-NekmeseHistory                                                                                                                  |
| Dialect:           | Kotos; Koro'oto hamlet                                                                                                                            |
| Location:          | Nekmese', Amarasi Selatan, Kupang                                                                                                                 |
| Date:              | 26/03/2016                                                                                                                                        |
| Speakers:          | Heronimus Bani                                                                                                                                    |
| Recorded by:       | Owen Edwards                                                                                                                                      |
| Transcribed by:    | Owen Edwards                                                                                                                                      |
| Interlinear by:    | Owen Edwards                                                                                                                                      |
| Indonesian/Kupang: | n./a.                                                                                                                                             |
| Free English by:   | Owen Edwards                                                                                                                                      |
| Genre:             | narrative                                                                                                                                         |
| Summary:           | a history of Koro'oto hamlet and Nekmese' village                                                                                                 |
| Length:            | 20.18                                                                                                                                             |
| Notes:             | several ambiguities in transcription checked by Heronimus Bani and Charles E. Grimes                                                              |

## D.2 Ro'is texts

R0-170820-1

|                  |                                                                                                                                                               |
|------------------|---------------------------------------------------------------------------------------------------------------------------------------------------------------|
| Item name:       | aazRO20170820_01                                                                                                                                              |
| Archive link:    | <a href="https://catalog.paradisec.org.au/collections/OE2/items/aazRO20170820_01">https://catalog.paradisec.org.au/collections/OE2/items/aazRO20170820_01</a> |
| Original name:   | aaz-RO-20170820-1-MartoniFeni-OpaJepang                                                                                                                       |
| Dialect:         | Ro'is; Suit hamlet                                                                                                                                            |
| Location:        | Buraen, Amarasi Selatan, Kupang                                                                                                                               |
| Date:            | 20/08/2017                                                                                                                                                    |
| Speakers:        | Martoni Feni                                                                                                                                                  |
| Recorded by:     | Owen Edwards                                                                                                                                                  |
| Transcribed by:  | Owen Edwards                                                                                                                                                  |
| Interlinear by:  |                                                                                                                                                               |
| Free English by: | Owen Edwards                                                                                                                                                  |

|          |                                                                            |
|----------|----------------------------------------------------------------------------|
| Genre:   | narrative                                                                  |
| Summary: | Martoni Feni tells the story of how his grandfather was a Japanese soldier |
| Length:  | 11.11                                                                      |
| Notes:   | Martoni's speech has some Kotos influences                                 |

---

|                  |                                                                                                                                                               |
|------------------|---------------------------------------------------------------------------------------------------------------------------------------------------------------|
| R0-170820-2      |                                                                                                                                                               |
| Item name:       | aazRO20170820_02                                                                                                                                              |
| Archive link:    | <a href="https://catalog.paradisec.org.au/collections/OE2/items/aazRO20170820_02">https://catalog.paradisec.org.au/collections/OE2/items/aazRO20170820_02</a> |
| Original name:   | aaz-RO-20170820-2-KetsiaBuraen-PengalamanHidup                                                                                                                |
| Dialect:         | Ro'is; Suit hamlet                                                                                                                                            |
| Location:        | Buraen, Amarasi Selatan, Kupang                                                                                                                               |
| Date:            | 20/08/2017                                                                                                                                                    |
| Speakers:        | Ketsia Buraen                                                                                                                                                 |
| Recorded by:     | Owen Edwards                                                                                                                                                  |
| Transcribed by:  | Owen Edwards                                                                                                                                                  |
| Interlinear by:  | n./a.                                                                                                                                                         |
| Free English by: | Owen Edwards                                                                                                                                                  |
| Genre:           | narrative                                                                                                                                                     |
| Summary:         | family history and life story of Ketsia                                                                                                                       |
| Length:          | 11.03                                                                                                                                                         |

---

|                  |                                                                                                                                                               |
|------------------|---------------------------------------------------------------------------------------------------------------------------------------------------------------|
| R0-170821-1      |                                                                                                                                                               |
| Item name:       | aazRO20170821_01                                                                                                                                              |
| Archive link:    | <a href="https://catalog.paradisec.org.au/collections/OE2/items/aazRO20170821_01">https://catalog.paradisec.org.au/collections/OE2/items/aazRO20170821_01</a> |
| Original name:   | aaz-RO-20170821-1-Rois-MelkiBuraen-LifeStory-Part1                                                                                                            |
| Dialect:         | Ro'is; Suit hamlet                                                                                                                                            |
| Location:        | Buraen, Amarasi Selatan, Kupang                                                                                                                               |
| Date:            | 21/08/2017                                                                                                                                                    |
| Speakers:        | Melki Buraen                                                                                                                                                  |
| Recorded by:     | Owen Edwards                                                                                                                                                  |
| Transcribed by:  | Owen Edwards (up to 5.43)                                                                                                                                     |
| Interlinear by:  | n./a.                                                                                                                                                         |
| Free English by: | Owen Edwards                                                                                                                                                  |
| Genre:           | narrative                                                                                                                                                     |
| Summary:         | Melki's life story                                                                                                                                            |

## D Text index

|                  |                                                                                                                                                               |
|------------------|---------------------------------------------------------------------------------------------------------------------------------------------------------------|
| Length:          | 41.09                                                                                                                                                         |
| <hr/> <hr/>      |                                                                                                                                                               |
| R0-170821-2      |                                                                                                                                                               |
| Item name:       | aazRO20170821_02                                                                                                                                              |
| Archive link:    | <a href="https://catalog.paradisec.org.au/collections/OE2/items/aazRO20170821_02">https://catalog.paradisec.org.au/collections/OE2/items/aazRO20170821_02</a> |
| Original name:   | aaz-RO-20170821-2-Rois-MelkiBuraen-LifeStory-Part2                                                                                                            |
| Dialect:         | Ro'is; Suit hamlet                                                                                                                                            |
| Location:        | Buraen, Amarasi Selatan, Kupang                                                                                                                               |
| Date:            | //2017                                                                                                                                                        |
| Speakers:        | Melki Buraen                                                                                                                                                  |
| Recorded by:     | Owen Edwards                                                                                                                                                  |
| Transcribed by:  | n./a.                                                                                                                                                         |
| Interlinear by:  | n./a.                                                                                                                                                         |
| Free English by: | n./a.                                                                                                                                                         |
| Genre:           | narrative                                                                                                                                                     |
| Summary:         | Melki's life story continued                                                                                                                                  |
| Length:          | 31.21                                                                                                                                                         |
| Notes:           | continuation of R0-170821-1                                                                                                                                   |
| <hr/> <hr/>      |                                                                                                                                                               |
| R0-170822-3      |                                                                                                                                                               |
| Item name:       | aazRO20170822_03                                                                                                                                              |
| Archive link:    | <a href="https://catalog.paradisec.org.au/collections/OE2/items/aazRO20170822_03">https://catalog.paradisec.org.au/collections/OE2/items/aazRO20170822_03</a> |
| Original name:   | aaz-RO-20170822-3-ToniBuraen-SukuWarnaKulit                                                                                                                   |
| Dialect:         | Ro'is; Suit hamlet                                                                                                                                            |
| Location:        | Buraen, Amarasi Selatan, Kupang                                                                                                                               |
| Date:            | 22/08/2017                                                                                                                                                    |
| Speakers:        | Toni Buraen                                                                                                                                                   |
| Recorded by:     | Owen Edwards                                                                                                                                                  |
| Transcribed by:  | Owen Edwards                                                                                                                                                  |
| Interlinear by:  | Owen Edwards                                                                                                                                                  |
| Free English by: | Owen Edwards                                                                                                                                                  |
| Genre:           | narrative                                                                                                                                                     |
| Summary:         | Toni talks about how there are two Amarasi tribes one of which has red skin and hair and one of which has white skin and hair                                 |
| Length:          | 2.04                                                                                                                                                          |

|                  |                                                                                                                                                               |
|------------------|---------------------------------------------------------------------------------------------------------------------------------------------------------------|
| Notes:           | Toni begins telling the story in Kupang Malay/Indonesian and only switches at 0.57                                                                            |
| <hr/>            |                                                                                                                                                               |
| R0-170824-1      |                                                                                                                                                               |
| Item name:       | aazRO20170822_04                                                                                                                                              |
| Archive link:    | <a href="https://catalog.paradisec.org.au/collections/OE2/items/aazRO20170822_04">https://catalog.paradisec.org.au/collections/OE2/items/aazRO20170822_04</a> |
| Original name:   | aaz-RO-20170824-1-ToniBuraen-Farming                                                                                                                          |
| Dialect:         | Ro'is; Suit hamlet                                                                                                                                            |
| Location:        | Buraen, Amarasi Selatan, Kupang                                                                                                                               |
| Date:            | 24/08/2017                                                                                                                                                    |
| Speakers:        | Toni Buraen                                                                                                                                                   |
| Recorded by:     | Owen Edwards                                                                                                                                                  |
| Transcribed by:  | Owen Edwards                                                                                                                                                  |
| Interlinear by:  | n./a.                                                                                                                                                         |
| Free English by: | Owen Edwards                                                                                                                                                  |
| Genre:           | procedural                                                                                                                                                    |
| Summary:         | Toni talks about farming practices                                                                                                                            |
| Length:          | 4.19                                                                                                                                                          |
| <hr/>            |                                                                                                                                                               |
| R0-170827-1      |                                                                                                                                                               |
| Item name:       | aazRO20170827_01                                                                                                                                              |
| Archive link:    | <a href="https://catalog.paradisec.org.au/collections/OE2/items/aazRO20170827_01">https://catalog.paradisec.org.au/collections/OE2/items/aazRO20170827_01</a> |
| Original name:   | aaz-RO-20170827-1-YansonNefoNeti-OldBeliefs                                                                                                                   |
| Dialect:         | Ro'is; Batuna hamlet                                                                                                                                          |
| Location:        | Tunbaun, Amarasi Barat, Kupang                                                                                                                                |
| Date:            | 27/08/2017                                                                                                                                                    |
| Speakers:        | Yanson Nefo Niti, Noh Nikson Aamnifu (introduction 0.22–1.26)                                                                                                 |
| Recorded by:     | Owen Edwards                                                                                                                                                  |
| Transcribed by:  | Owen Edwards                                                                                                                                                  |
| Interlinear by:  | n./a.                                                                                                                                                         |
| Free English by: | Owen Edwards                                                                                                                                                  |
| Genre:           | history                                                                                                                                                       |
| Summary:         | Yanson talks about the traditional religious practices in Amarasi                                                                                             |
| Length:          | 8.57                                                                                                                                                          |
| <hr/>            |                                                                                                                                                               |

## D Text index

|                  |                                                                                                                                                               |
|------------------|---------------------------------------------------------------------------------------------------------------------------------------------------------------|
| R0-170827-2      |                                                                                                                                                               |
| Item name:       | aazRO20170827_02                                                                                                                                              |
| Archive link:    | <a href="https://catalog.paradisec.org.au/collections/OE2/items/aazRO20170827_02">https://catalog.paradisec.org.au/collections/OE2/items/aazRO20170827_02</a> |
| Original name:   | aaz-RO-20170827-2-NohNiksonAamnifu-Marriage                                                                                                                   |
| Dialect:         | Ro'is; Batuna hamlet                                                                                                                                          |
| Location:        | Tunbaun, Amarasi Barat, Kupang                                                                                                                                |
| Date:            | 27/08/2017                                                                                                                                                    |
| Speakers:        | Noh Nikson Aamnifu                                                                                                                                            |
| Recorded by:     | Owen Edwards                                                                                                                                                  |
| Transcribed by:  | n./a.                                                                                                                                                         |
| Interlinear by:  | n./a.                                                                                                                                                         |
| Free English by: | Owen Edwards                                                                                                                                                  |
| Genre:           | history                                                                                                                                                       |
| Summary:         | 3.47                                                                                                                                                          |
| Length:          | traditional marriage practices in Amarasi                                                                                                                     |
| R0-170827-3      |                                                                                                                                                               |
| Item name:       | aazRO20170827_03                                                                                                                                              |
| Archive link:    | <a href="https://catalog.paradisec.org.au/collections/OE2/items/aazRO20170827_03">https://catalog.paradisec.org.au/collections/OE2/items/aazRO20170827_03</a> |
| Original name:   | aaz-RO-20170827-3-MelianusObhetan-BatunaLeaders                                                                                                               |
| Dialect:         | Ro'is; Batuna hamlet                                                                                                                                          |
| Location:        | Tunbaun, Amarasi Barat, Kupang                                                                                                                                |
| Date:            | 27/08/2017                                                                                                                                                    |
| Speakers:        | Melianus Obhetan                                                                                                                                              |
| Recorded by:     | Owen Edwards                                                                                                                                                  |
| Transcribed by:  | Owen Edwards                                                                                                                                                  |
| Interlinear by:  | n./a.                                                                                                                                                         |
| Free English by: | Owen Edwards                                                                                                                                                  |
| Genre:           | history                                                                                                                                                       |
| Summary:         | the village leaders of Batuna                                                                                                                                 |
| Length:          | 6.41                                                                                                                                                          |
| R0-170829-1      |                                                                                                                                                               |
| Item name:       | aazRO20170829_01                                                                                                                                              |
| Archive link:    | <a href="https://catalog.paradisec.org.au/collections/OE2/items/aazRO20170829_01">https://catalog.paradisec.org.au/collections/OE2/items/aazRO20170829_01</a> |
| Original name:   | aaz-RO-20170829-1-YansonNefoNiti-Christianity                                                                                                                 |

|                  |                                                                                                |
|------------------|------------------------------------------------------------------------------------------------|
| Dialect:         | Ro'is; Batuna hamlet                                                                           |
| Location:        | Tunbaun, Amarasi Barat, Kupang                                                                 |
| Date:            | 29/08/2017                                                                                     |
| Speakers:        | Yanson Nefo Niti, Melianus Obhetan (introduction 0.02–0.33)                                    |
| Recorded by:     | Owen Edwards                                                                                   |
| Transcribed by:  | Owen Edwards                                                                                   |
| Interlinear by:  | n./a.                                                                                          |
| Free English by: | Owen Edwards                                                                                   |
| Genre:           | history                                                                                        |
| Summary:         | Description of traditional religion, the coming of Christianity, as well as Christian beliefs. |
| Length:          | 19.48                                                                                          |

---

|                  |                                                                                                                                                               |
|------------------|---------------------------------------------------------------------------------------------------------------------------------------------------------------|
| R0-170830-1      |                                                                                                                                                               |
| Item name:       | aazRO20170830_01                                                                                                                                              |
| Archive link:    | <a href="https://catalog.paradisec.org.au/collections/OE2/items/aazRO20170830_01">https://catalog.paradisec.org.au/collections/OE2/items/aazRO20170830_01</a> |
| Original name:   | aaz-RO-20170830-1-NitanelRuku-HistoryOFRuanRete                                                                                                               |
| Dialect:         | Ro'is; Ruanrete hamlet                                                                                                                                        |
| Location:        | Tunbaun, Amarasi Barat, Kupang                                                                                                                                |
| Date:            | 30/08/2017                                                                                                                                                    |
| Speakers:        | Nitanel Ruku, Melianus Obhetan (introduction 0.02–0.36)                                                                                                       |
| Recorded by:     | Owen Edwards                                                                                                                                                  |
| Transcribed by:  | Owen Edwards                                                                                                                                                  |
| Interlinear by:  | n./a.                                                                                                                                                         |
| Free English by: | Owen Edwards                                                                                                                                                  |
| Genre:           | history                                                                                                                                                       |
| Summary:         | 1. history of Ruanrete village (00.51–5.38)<br>2. marriage practices in Amarasi (5.42–end)                                                                    |
| Length:          | 10.30                                                                                                                                                         |

---

|                |                                                                                                                                                               |
|----------------|---------------------------------------------------------------------------------------------------------------------------------------------------------------|
| R0-170830-2    |                                                                                                                                                               |
| Item name:     | aazRO20170830_02                                                                                                                                              |
| Archive link:  | <a href="https://catalog.paradisec.org.au/collections/OE2/items/aazRO20170830_02">https://catalog.paradisec.org.au/collections/OE2/items/aazRO20170830_02</a> |
| Original name: | aaz-RO-20170830-2-DominggusRuku-VariousMatters                                                                                                                |
| Dialect:       | Ro'is; Ruanrete hamlet                                                                                                                                        |

## D Text index

|                  |                                |
|------------------|--------------------------------|
| Location:        | Tunbaun, Amarasi Barat, Kupang |
| Date:            | 30/08/2017                     |
| Speakers:        | Dominggus Ruku                 |
| Recorded by:     | Owen Edwards                   |
| Transcribed by:  | n./a.                          |
| Interlinear by:  | n./a.                          |
| Free English by: | Owen Edwards                   |
| Genre:           |                                |
| Summary:         |                                |
| Length:          | 14.24                          |

---

---

R0-170830-3

|                  |                                                                                                                                                               |
|------------------|---------------------------------------------------------------------------------------------------------------------------------------------------------------|
| Item name:       | aazRO20170830_03                                                                                                                                              |
| Archive link:    | <a href="https://catalog.paradisec.org.au/collections/OE2/items/aazRO20170830_03">https://catalog.paradisec.org.au/collections/OE2/items/aazRO20170830_03</a> |
| Original name:   | aaz-RO-20170830-3-ArbenRuku-ShortLifeStory                                                                                                                    |
| Dialect:         | Ro'is; Ruanrete hamlet                                                                                                                                        |
| Location:        | Tunbaun, Amarasi Barat, Kupang                                                                                                                                |
| Date:            | 30/08/2017                                                                                                                                                    |
| Speakers:        | Arben Ruku, Melianus Obhetan (introduction 0.00–0.16)                                                                                                         |
| Recorded by:     | Owen Edwards                                                                                                                                                  |
| Transcribed by:  | Owen Edwards                                                                                                                                                  |
| Interlinear by:  | n./a.                                                                                                                                                         |
| Free English by: | Owen Edwards                                                                                                                                                  |
| Genre:           | narrative                                                                                                                                                     |
| Summary:         | Arben's life story and family                                                                                                                                 |
| Length:          | 4.11                                                                                                                                                          |

---

---

R0-170830-4

|                |                                                                                                                                                               |
|----------------|---------------------------------------------------------------------------------------------------------------------------------------------------------------|
| Item name:     | aazRO20170830_04                                                                                                                                              |
| Archive link:  | <a href="https://catalog.paradisec.org.au/collections/OE2/items/aazRO20170830_04">https://catalog.paradisec.org.au/collections/OE2/items/aazRO20170830_04</a> |
| Original name: | aaz-RO-20170830-4-TrayanusObhetan-MafuutneekMountain                                                                                                          |
| Dialect:       | Ro'is; Batuna hamlet                                                                                                                                          |
| Location:      | Tunbaun, Amarasi Barat, Kupang                                                                                                                                |
| Date:          | 30/08/2017                                                                                                                                                    |
| Speakers:      | Trayanus Obhetan, Melianus Obhetan (introduction 0.00–0.36)                                                                                                   |



|                  |                                             |
|------------------|---------------------------------------------|
| Recorded by:     | Owen Edwards                                |
| Transcribed by:  | Owen Edwards                                |
| Interlinear by:  | n./a.                                       |
| Free English by: | Owen Edwards                                |
| Genre:           | narrative                                   |
| Summary:         | how the mountain of Mafuutneek got its name |
| Length:          | 8.15                                        |

---



---

R0-170830-5

|                  |                                                                                                                                                               |
|------------------|---------------------------------------------------------------------------------------------------------------------------------------------------------------|
| Item name:       | aazRO20170830_05                                                                                                                                              |
| Archive link:    | <a href="https://catalog.paradisec.org.au/collections/OE2/items/aazRO20170830_05">https://catalog.paradisec.org.au/collections/OE2/items/aazRO20170830_05</a> |
| Original name:   | aaz-RO-20170830-5-MelianusObhetan-RaanUuf                                                                                                                     |
| Dialect:         | Ro'is; Batuna hamlet                                                                                                                                          |
| Location:        | Tunbaun, Amarasi Barat, Kupang                                                                                                                                |
| Date:            | 30/08/2017                                                                                                                                                    |
| Speakers:        | Melianus Obhetan                                                                                                                                              |
| Recorded by:     | Owen Edwards                                                                                                                                                  |
| Transcribed by:  | Owen Edwards                                                                                                                                                  |
| Interlinear by:  | n./a.                                                                                                                                                         |
| Free English by: | Owen Edwards                                                                                                                                                  |
| Genre:           | narrative                                                                                                                                                     |
| Summary:         | the story of Raan Uuf, a place where the king would hold meetings with his subjects                                                                           |
| Length:          | 6.13                                                                                                                                                          |

---



---

R0-170901-1

|                 |                                                                                                                                                                                   |
|-----------------|-----------------------------------------------------------------------------------------------------------------------------------------------------------------------------------|
| File-name:      | aazRO20170901_GatmelFamily                                                                                                                                                        |
| Archive-link:   | <a href="https://catalog.paradisec.org.au/collections/OE2/items/aazRO20170901_GatmelFamily">https://catalog.paradisec.org.au/collections/OE2/items/aazRO20170901_GatmelFamily</a> |
| Original Name:  | aaz-RO-20170901-1-GatmelBana-VillageFamily                                                                                                                                        |
| Dialect:        | Ro'is; Batuna hamlet                                                                                                                                                              |
| Location:       | Desa Tunbaun, Amarasi Barat, Timor, Indonesia                                                                                                                                     |
| Date:           | 01/09/2017                                                                                                                                                                        |
| Speaker(s):     | Gatmel Daniel Bana', Melianus Obhetan<br>(introduction 0.01–1.01)                                                                                                                 |
| Recorded by:    | Owen Edwards, Melianus Obhetan                                                                                                                                                    |
| Transcribed by: | Owen Edwards                                                                                                                                                                      |
| Interlinear by: | Owen Edwards                                                                                                                                                                      |

## D Text index

|                  |                                                                                                                                                                                                                                                                                                                                                                                                                                                                                    |
|------------------|------------------------------------------------------------------------------------------------------------------------------------------------------------------------------------------------------------------------------------------------------------------------------------------------------------------------------------------------------------------------------------------------------------------------------------------------------------------------------------|
| Free English by: | Owen Edwards                                                                                                                                                                                                                                                                                                                                                                                                                                                                       |
| Checked?         | Unclear sections checked by Owen Edwards with Melianus Obhetan.                                                                                                                                                                                                                                                                                                                                                                                                                    |
| Genre:           | narrative                                                                                                                                                                                                                                                                                                                                                                                                                                                                          |
| Summary:         | Gatmel talks about his family and its history.                                                                                                                                                                                                                                                                                                                                                                                                                                     |
| <hr/> <hr/>      |                                                                                                                                                                                                                                                                                                                                                                                                                                                                                    |
| R0-170902-1      |                                                                                                                                                                                                                                                                                                                                                                                                                                                                                    |
| Item name:       | aazRO20170902_01                                                                                                                                                                                                                                                                                                                                                                                                                                                                   |
| Archive link:    | <a href="https://catalog.paradisec.org.au/collections/OE2/items/aazRO20170902_01">https://catalog.paradisec.org.au/collections/OE2/items/aazRO20170902_01</a>                                                                                                                                                                                                                                                                                                                      |
| Original name:   | aaz-RO-20170902-1-TonciNiti-AncientLanguages-OtherStories                                                                                                                                                                                                                                                                                                                                                                                                                          |
| Dialect:         | Ro'is; Batuna hamlet                                                                                                                                                                                                                                                                                                                                                                                                                                                               |
| Location:        | Tunbaun, Amarasi Barat, Kupang                                                                                                                                                                                                                                                                                                                                                                                                                                                     |
| Date:            | 02/09/2017                                                                                                                                                                                                                                                                                                                                                                                                                                                                         |
| Speakers:        | Tonci Niti, Melianus Obhetan, Trayanus Obhetan                                                                                                                                                                                                                                                                                                                                                                                                                                     |
| Recorded by:     | Owen Edwards                                                                                                                                                                                                                                                                                                                                                                                                                                                                       |
| Transcribed by:  | Owen Edwards                                                                                                                                                                                                                                                                                                                                                                                                                                                                       |
| Interlinear by:  | n./a.                                                                                                                                                                                                                                                                                                                                                                                                                                                                              |
| Free English by: | Owen Edwards                                                                                                                                                                                                                                                                                                                                                                                                                                                                       |
| Genre:           | narratives                                                                                                                                                                                                                                                                                                                                                                                                                                                                         |
| Summary:         | 1. the first inhabitants of Timor (1.24–3.12)<br>2. numerals of previous generations of inhabitants (3.16–12.07). In this section Trayanus was taking notes and there is lots of discussion between him and Tonci as Trayanus writes down the numbers<br>3. How the village of Raakase got its name (12.48–13.45)<br>4. Foreigners who visited Timor and Indonesian history (13.50–17.54)<br>5. Original clans in Batuna (18.02–19.51)<br>6. How Batuna got its name (20.01–20.53) |
| Length:          | 20.53                                                                                                                                                                                                                                                                                                                                                                                                                                                                              |
| Notes:           | Tonci does not appear to use metathesis of consonant-final verbs consistently in the same way as other speakers of Ro'is (§7.11)                                                                                                                                                                                                                                                                                                                                                   |
| <hr/> <hr/>      |                                                                                                                                                                                                                                                                                                                                                                                                                                                                                    |
| R0-170902-2      |                                                                                                                                                                                                                                                                                                                                                                                                                                                                                    |
| Item name:       | aazRO20170902_02                                                                                                                                                                                                                                                                                                                                                                                                                                                                   |

|                  |                                                                                                                                                               |
|------------------|---------------------------------------------------------------------------------------------------------------------------------------------------------------|
| Archive link:    | <a href="https://catalog.paradisec.org.au/collections/OE2/items/aazRO20170902_02">https://catalog.paradisec.org.au/collections/OE2/items/aazRO20170902_02</a> |
| Original name:   | aaz-RO-20170902-2-TonciNiti-GroupsMuplesOfNine                                                                                                                |
| Dialect:         | Ro'is; Batuna hamlet                                                                                                                                          |
| Location:        | Tunbaun, Amarasi Barat, Kupang                                                                                                                                |
| Date:            | 02/09/2017                                                                                                                                                    |
| Speakers:        | Tonci Niti, Melianus Obhetan, Trayanus Obhetan                                                                                                                |
| Recorded by:     | Owen Edwards                                                                                                                                                  |
| Transcribed by:  | Owen Edwards                                                                                                                                                  |
| Interlinear by:  | n./a.                                                                                                                                                         |
| Free English by: | Owen Edwards                                                                                                                                                  |
| Genre:           | narratives                                                                                                                                                    |
| Summary:         |                                                                                                                                                               |
| Length:          | 21.46                                                                                                                                                         |

---



---

R0-170917-1

|                  |                                                                                                                                                                                                                                                                                                                                                                                                                                              |
|------------------|----------------------------------------------------------------------------------------------------------------------------------------------------------------------------------------------------------------------------------------------------------------------------------------------------------------------------------------------------------------------------------------------------------------------------------------------|
| Item name:       | aazRO20170917_01                                                                                                                                                                                                                                                                                                                                                                                                                             |
| Archive link:    | <a href="https://catalog.paradisec.org.au/collections/OE2/items/aazRO20170917_01">https://catalog.paradisec.org.au/collections/OE2/items/aazRO20170917_01</a>                                                                                                                                                                                                                                                                                |
| Original name:   | aaz-RO-20170917-1-TonciNiti-BahasaPurbakala                                                                                                                                                                                                                                                                                                                                                                                                  |
| Dialect:         | Ro'is; Batuna hamlet                                                                                                                                                                                                                                                                                                                                                                                                                         |
| Location:        | Tunbaun, Amarasi Barat, Kupang                                                                                                                                                                                                                                                                                                                                                                                                               |
| Date:            | 17/09/2017                                                                                                                                                                                                                                                                                                                                                                                                                                   |
| Speakers:        | Tonci Niti, Melianus Obhetan (introduction 0.02–0.27)                                                                                                                                                                                                                                                                                                                                                                                        |
| Recorded by:     | Owen Edwards                                                                                                                                                                                                                                                                                                                                                                                                                                 |
| Transcribed by:  | Owen Edwards                                                                                                                                                                                                                                                                                                                                                                                                                                 |
| Interlinear by:  | n./a.                                                                                                                                                                                                                                                                                                                                                                                                                                        |
| Free English by: | Owen Edwards                                                                                                                                                                                                                                                                                                                                                                                                                                 |
| Genre:           |                                                                                                                                                                                                                                                                                                                                                                                                                                              |
| Summary:         | <ol style="list-style-type: none"> <li>1. Numerals of previous generations (00.35–1.53)</li> <li>2. Ancient language <i>burbaa'-burbaa'</i> which can be used to make rocks and trees attack your enemies (1.57–2.30)</li> <li>3. Original four clans of Tunbaun (2.35–5.17)</li> <li>4. The original king of Amarasi and how people learnt to cook rice (5.26–9.48)</li> <li>5. The Obhetans are leaders of Tunbaun (9.51–11.57)</li> </ol> |

*D Text index*

|                  |                                                                                                                                                               |
|------------------|---------------------------------------------------------------------------------------------------------------------------------------------------------------|
| Length:          | 11.59                                                                                                                                                         |
| <hr/> <hr/>      |                                                                                                                                                               |
| R0-170917-2      |                                                                                                                                                               |
| Item name:       | aazRO20170917_02                                                                                                                                              |
| Archive link:    | <a href="https://catalog.paradisec.org.au/collections/OE2/items/aazRO20170917_02">https://catalog.paradisec.org.au/collections/OE2/items/aazRO20170917_02</a> |
| Original name:   | aaz-RO-20170917-2-TonciNiti-VariousStories                                                                                                                    |
| Dialect:         | Ro'is; Batuna hamlet                                                                                                                                          |
| Location:        | Tunbaun, Amarasi Barat, Kupang                                                                                                                                |
| Date:            | 17/09/2017                                                                                                                                                    |
| Speakers:        | Tonci Niti, Melianus Obhetan                                                                                                                                  |
| Recorded by:     | Owen Edwards                                                                                                                                                  |
| Transcribed by:  | n./a.                                                                                                                                                         |
| Interlinear by:  | n./a.                                                                                                                                                         |
| Free English by: | Owen Edwards                                                                                                                                                  |
| Length:          | 46.05                                                                                                                                                         |

# References

- Adelaar, Alexander. 2005. The Austronesian languages of South East Asia and Madagascar: A historical perspective. In Alexander Adelaar & Nikolaus P. Himmelmann (eds.), *The Austronesian Languages of Asia and Madagascar*, 1–41. London & New York: Routledge.
- Aikhenvald, Alexandra Y. 2006. Serial verb constructions in typological perspective. In Alexandra Y. Aikhenvald & Robert M. W. Dixon (eds.), *Serial verb constructions: A cross-linguistic typology*, 1–68. Oxford: Oxford University Press.
- Anderson, Cormac. 2016. *Consonant colour and vocalism in the history of Irish*. Adam Mickiewicz University in Poznań. (Doctoral dissertation).
- Anderson, Stephen. 1992. *A-morphous morphology*. Cambridge: Cambridge University Press.
- Balle, Misriani. 2015. *Types of reduplication in Helong*. Paper presented at the 25th Annual Meeting of the Southeast Asian Linguistics Society, Chiang Mai, May 27–29.
- Balle, Misriani. 2017. *Types of reduplication in Helong, an Austronesian language in eastern Indonesia*. Payap University. (MA thesis). [https://inter.payap.ac.th/wp-content/uploads/linguistics\\_students/Misriani\\_Balle\\_MA\\_Thesis.pdf](https://inter.payap.ac.th/wp-content/uploads/linguistics_students/Misriani_Balle_MA_Thesis.pdf).
- Balle, Misriani & Stuart Cameron. 2012. *Panduan untuk menulis bahasa Helong, serta tata bahasa singkat*. Kupang: Unit Bahasa & Budaya.
- Banamtuan, Johnny M. 2018. *Metathesis in Wersing: A non-Austronesian language of eastern Alor*. Paper presented at the Seventh East Nusantara Conference, Kupang, May 14–15.
- Bates, Dawn, Thom Hess & Vi Hilbert. 1994. *Lushootseed dictionary*. Seattle: University of Washington Press.
- Besnier, Niko. 1987. An autosegmental approach to metathesis in Rotuman. *Lingua* 73. 201–223.
- Blevins, Juliette. 1995. The syllable in phonological theory. In John Goldsmith (ed.), *The handbook of phonological theory*, 206–244. Cambridge, Massachusetts: Blackwell.
- Blevins, Juliette & Andrew Garrett. 1998. The origins of consonant-vowel metathesis. *Language* 74(3). 508–556.

## References

- Blevins, Juliette & Andrew Garrett. 2004. The evolution of metathesis. In Bruce Hayes, Robert Kirchner & Donca Steriade (eds.), *Phonetically based phonology*, 375–403. Cambridge: Cambridge University Press.
- Blust, Robert. 1981. The linguistic value of the Wallace Line. *Bijdragen tot de Taal-, Land- en Volkenkunde* 138. 241–293.
- Blust, Robert. 1993. Central and Central-Eastern Malayo-Polynesian. *Oceanic Linguistics* 32. 241–293.
- Blust, Robert. 2003. Three notes on early Austronesian morphology. *Oceanic Linguistics* 42(2). 438–478.
- Blust, Robert. 2009. The position of the languages of eastern Indonesia: A reply to Donohue and Grimes. *Oceanic Linguistics* 48. 36–77.
- Blust, Robert & Stephen Trussel. ongoing. *The Austronesian comparative dictionary*. <http://www.trussel2.com/ACD/>.
- Bresnan, Joan, Ash Asudeh, Ida Toivonen & Stephen Wechsler. 2016. *Lexical-functional syntax*. Wiley Blackwell.
- Brockhaus, Wiebke. 1995. *Final devoicing in the phonology of German*. Tübingen: Max Niemeyer Verlag.
- Buckley, Eugene. 2007. Vowel-sonorant metathesis in Alsea. *International Journal of American Linguistics* 73(1). 1–39.
- Capell, Arthur. 1944a. Peoples and languages of Timor. *Oceania* 14. 311–337.
- Capell, Arthur. 1944b. Peoples and languages of Timor (continued). *Oceania* 15. 19–48.
- Churchward, Clerk Maxwell. 1939. *Tales of a lonely island: Rotuman legends*. Sydney: The Australian National Research Council.
- Churchward, Clerk Maxwell. 1940. *Rotuman grammar and dictionary*. Methodist Church of Australasia, Department of Overseas Missions.
- Clements, George & Samuel Keyser. 1983. *CV phonology: A generative theory of the syllable* (Linguistic Inquiry Monographs 9). Cambridge, Massachusetts: The MIT Press.
- Comrie, Bernard. 1976. *Aspect: An introduction to the study of verbal aspect and related problems*. Cambridge: Cambridge University Press.
- Coward, David & Naomi Coward. 2000. A phonological sketch of the Selaru language. In Charles E. Grimes (ed.), *Spices from the East: Papers in languages of eastern Indonesia*, 9–54. Canberra: Pacific Linguistics.
- Cowell, Mark W. 1964. *A reference grammar of Syrian Arabic* (Arabic Series 7). Washington D.C.: Georgetown University Press.

- Culhane, Kirsten. 2018. *Consonant insertions: A synchronic and diachronic account of Amfo'an*. Australian National University. (Honours thesis). <http://hdl.handle.net/1885/160794>.
- Cunningham, Clark E. 1962. *People of the dry land: A study of the soical organisation of an Indonesian people*. University of Oxford. (Doctoral dissertation).
- Cunningham, Clark E. 1964. Order in the Atoni house. *Bijdragen tot de Taal-, Land- en Volkenkunde* 120. 34–68.
- de Vaan, Michiel. 2017. *The dawn of Dutch: Language contact in the Western Low Countries before 1200*. Amsterdam/Philadelphia: John Benjamins.
- Demers, Richard A. 1974. Alternating roots in Lummi. *International Journal of American Linguistics* 40(1). 15–21.
- Donohue, Mark. 2003. The laryngeal gesture in Austronesian languages: A terminological quibble. *Oceanic Linguistics* 42. 213–217.
- Donohue, Mark. 2008. Covert word classes: Seeking your own syntax in Tukang Besi. *Studies in Language* 32. 590–609.
- Donohue, Mark & Charles E. Grimes. 2008. Yet more on the position of the languages of eastern Indonesia and East Timor. *Oceanic Linguistics* 47. 114–158.
- Dooley, Robert & Stephen H. Levinsohn. 2001. *Analyzing discourse: A manual of basic concepts*. Dallas, Texas: SIL International.
- Dryer, Matthew S. 2013. *A grammatical description of Kara-Lemakot*. Canberra: Asia-Pacific Linguistics.
- Durand, Jacques. 1990. *Generative and non-linear phonology*. London: Longman.
- Edwards, John. 2009. *Language and identity: An introduction*. Cambridge: Cambridge University Press.
- Edwards, Owen. 2016a. Amarasi. *Journal of the International Phonetic Association* 46(1). 113–125.
- Edwards, Owen. 2016b. *Metathesis and unmetathesis: Parallelism and complementarity in Amarasi, Timor*. The Australian National University. (Doctoral dissertation). <http://hdl.handle.net/1885/114481>.
- Edwards, Owen. 2016c. Parallel sound correspondences in Uab Meto. *Oceanic Linguistics* 55(1). 52–86. <http://hdl.handle.net/1885/108661>.
- Edwards, Owen. 2017. Epenthetic and contrastive glottal stops in Amarasi. *Oceanic Linguistics* 56. 415–434. <http://hdl.handle.net/1887/55974>.
- Edwards, Owen. 2018a. Parallel histories in Rote-Meto. *Oceanic Linguistics* 57. 359–409. <http://hdl.handle.net/1887/67592>.
- Edwards, Owen. 2018b. Preliminary report on Funai Helong. *NUSA: Linguistic studies of languages in and around Indonesia* 65. 1–27. <http://repository.tufs.ac.jp/handle/10108/92897>.

## References

- Edwards, Owen. 2018c. Top-down historical phonology of Rote-Meto. *Journal of the Southeast Asian Linguistics Society* 11. 63–90. <http://hdl.handle.net/10524/52421>.
- Edwards, Owen. 2019. Reintroducing Welaun. *Oceanic Linguistics* 58. 31–58. <http://hdl.handle.net/1887/79038>.
- Edwards, Owen. 2020. *Primary data for: Metathesis and unmetathesis in Amarasi*. Version V1. <https://doi.org/10.18710/IORWF6>. DOI:10.18710/IORWF6
- Fishman, Joshua A. & Ofelia García (eds.). 2010. *Handbook of language and ethnic identity*. 2nd edn. Vol. 1. Oxford: Oxford University Press US.
- Fogaça, Helem Andressa de Oliveira. 2017. *O ecossistema fundamental da língua Mambae : Aspectos endoecológicos e exoecológicos de uma língua austronésia de Timor-Leste*. Universidade de Brasília. (Doctoral dissertation). <http://repositorio.unb.br/handle/10482/31396>.
- Fox, James J. 1974. ‘our ancestors spoke in pairs’: Rotinese views of language, dialect, and code. In Richard Bauman & Joel Scherzer (eds.), *Explorations in the ethnography of speaking*, 65–85. Cambridge: Cambridge University Press.
- Fox, James J. 1988. The historical consequences of changing patterns of livelihood in Timor. In Deborah Wade-Marshall & Peter Loveday (eds.), *Contemporary issues in development*, 259–279. Darwin: Australian National University North Australia Research Unit.
- Fox, James J. 1989. Category and complement: Binary ideologies and the organization of dualism in eastern indonesia. In David Maybury-Lewis & Uri Almagor (eds.), *The attraction of opposites: Thought and society in the dualistic mode*, 33–56. Ann Arbor: The University of Michigan Press.
- Fox, James J. 1994. Reflections on “hierarchy” and “precedence”. *History and Anthropology* 7. 87–108.
- Fox, James J. 1999. Precedence in practice among the Atoni Pah Meto of Timor. In Lorraine V. Aragon & Susan D. Russell (eds.), *Structuralism’s transformations: Order and revision in Indonesian and Malaysian societies. papers written in honor of Clark E. Cunningham*, 3–36. Tempe: Arizona State University Program for Southeast Asian Studies.
- Fox, James J. 2014. *Explorations in semantic parallelism*. Canberra: ANU Press.
- Freeland, L. S. 1951. Language of the Sierra Miwok. *International Journal of American linguistics Memoir* 6.
- Goldsmith, John. 1976. *Autosegmental phonology*. Massachusetts Institute of Technology. (Doctoral dissertation).
- Gordon, E. V. 1957. *An introduction to Old Norse*. 2nd. Oxford: Oxford University Press. revised by A. R. Taylor.



- Grace, George. 1959. *The position of the Polynesian languages within the Austronesian (Malayo-Polynesian) language family* (Indiana University Publications in Anthropology and Linguistics, Memoir 16). Baltimore: Waverly Press.
- Grimes, Charles E. 1991. *The Buru language of eastern Indonesia*. Australian National University. (Doctoral dissertation). <https://openresearch-repository.anu.edu.au/handle/1885/10925>.
- Grimes, Charles E. 2010. Hawu and Dhao in eastern Indonesia: Revisiting their relationship. In Michael Ewing & Marian Klamer (eds.), *East Nusantara: Typological and areal analysis*, 251–280. Canberra: Pacific Linguistics.
- Grimes, Charles E. & Heronimus Bani. 2011. *Ethno-mathematics in Amarasi: How to count 400 ears of corn in 60 seconds*. Paper presented at the 12th International Conference on Language Documentation & Conservation. Honolulu, February 11–13.
- Grimes, Charles E., Heronimus Bani & Agustinho Caet. 2012. *Quantifying things in the grammars of Amarasi (eastern Indonesia) and Baikeno (Timor Leste)*. Paper presented at the 12th International Conference on Austronesian Linguistics, Bali, July 2–6.
- Grimes, Charles E., Carlos Marçal & Paolino Ferreira. 2014. *Introductory dictionary of Mambae (Same): Mambae–English, English–Mambae, Mambae–Indonesia–Tetun Dili, Indonesia–Mambae, Tetun Dili–Mambae*. Darwin: Australian Society for Indigenous Languages.
- Grimes, Charles E., Tom Therik, Barbara Dix Grimes & Max Jacob. 1997. *A guide to the people and languages of Nusa Tenggara*. Kupang: Artha Wacana Press. <http://www.ausil.org.au/node/3744>.
- Hajek, John & John Bowden. 2002. A phonological oddity in the Austronesian area: Ejectives in Waimoa. *Oceanic Linguistics* 41. 222–224.
- Hajek, John & Nikolaus P. Himmelmann. 2006. Notes on Waima’a phonology and orthography. In Belo Maurício C. A., John Bowden, John Hajek, Nikolaus P. Himmelmann & Alexandre V. Tilman (eds.), *DoBeS Waima’a documentation*. DoBeS Archive MPI Nijmegen.
- Hale, Kenneth & A. Lacayo Blanco. 1989. *Diccionario elemental del Ulwa (sumu meridional)*. Cambridge: Center for Cognitive Science, MIT.
- Hale, Mark & Madelyn Kisson. 1998. The phonology-syntax interface in Rotuman. In Matthew Pearson (ed.), *Recent papers in Austronesian linguistics: Proceedings of the third and fourth meetings of the Austronesian Formal Linguistics Association (AFLA)*, 115–128. Los Angeles: UCLA Department of Linguistics.
- Harbert, Wayne. 2007. *The Germanic languages*. Cambridge: Cambridge University Press.

## References

- Hayes, Bruce. 1994. *Metrical stress theory*. Chicago: Chicago University Press.
- Heider, Paul M., Adam Hatfield & Jennifer Wilson. 2011. Repurposing Bible translations for grammar sketches. *Studies in the Linguistic Sciences: Illinois Working Papers*. 51–65.
- Heinz, Jeffrey. 2004. *CV metathesis in Kwara'ae*. University of California. (MA thesis).
- Heinz, Jeffrey. 2005. Optional partial metathesis in Kwara'ae. In Jeffrey Heinz & Dimitris Ntelitheos (eds.), *Proceedings of the twelfth annual conference of the Austronesian Formal Linguistics Association (AFLA)*, vol. 12 (UCLA Working Papers in Linguistics), 91–102. Los Angeles: UCLA Working Papers in Linguistics.
- Himmelman, Nikolaus P. & Daniel Kaufman. to appear. Prosodic systems: Austronesia. In Carlos Gussenhoven & Aaju Chen (eds.), *The Oxford handbook of language prosody*. Oxford University Press.
- Hólmarsson, Sverrir, Christopher Sanders & John Tucker. 1989. *Íslensk-ensk orðabók / concise Icelandic-English dictionary*. Reykjavík: Iðunn.
- Hukari, Thomas. 1978. Halkomelem nonsegmental morphology. In *Proceedings of the 13th international conference on Salish and neighbouring languages*, 157–209.
- Hukari, Thomas & Ruby Peter (eds.). 1995. *The Cowichan dictionary of the Hul'qumi'num' dialect of the Cowichan people*. Cowichan Tribes.
- Hume, Elizabeth. 1998. Metathesis in phonological theory: The case of Leti. *Lingua* 104. 147–86.
- Hume, Elizabeth. 2004. The indeterminacy/attestation model of metathesis. *Language* 80. 203–237.
- Hume, Elizabeth & Misun Seo. 2004. Metathesis in Faroese and Lithuanian: From speech perception to optimality theory. *Nordic Journal of Linguistics* 27(1). 35–60.
- Isu, Rudolof Jibrael. 2013. *Teori optimalisasi, fonologi bahasa Dawan, sebuah kajian deskriptif*. Surabaya: Jengala Pustaka Utama.
- Itô, Junko & Armin Mester. 1999. Realignment. In René Kager, Harry van der Hulst & Wim Zonneveld (eds.), *The prosody-morphology interface*, 188–217. Cambridge: Cambridge University Press.
- Jacob, June & Charles E. Grimes. 2011. Aspect and directionality in Kupang Malay serial verb constructions: Calquing on the grammars of substrate languages. In Claire Lefebvre (ed.), *Creoles, their substrates, and language typology*, 337–366. Amsterdam & Philadelphia: John Benjamins.

- Jonker, J. C. G. 1904. Eenige verhalen in talen, gesproken op Sumbawa, Timor en omliggende eilanden. *Bijdragen tot de Taal-, Land- en Volkenkunde van Nederlandsch-Indië* 56. 245–289.
- Jonker, J. C. G. 1906. Over de eind-medeklinkers in het Rottineesch en Timoreesch. *Bijdragen tot de Taal-, Land- en Volkenkunde van Nederlandsch-Indië* 59. 263–343.
- Jonker, J. C. G. 1908. *Rottineesch–Hollandsch woordenboek*. Leiden: E. J. Brill.
- Kawachi, Kazuhiro. 2007. *A grammar of Sidaama (Sidamo), a Cushitic language of Ethiopia*. University at Buffalo. (Doctoral dissertation).
- Kenstowicz, Michael & Charles Kisseberth. 1977. *Topics in phonological theory*. New York: Academic Press.
- Kilani-Schoch, Marianne & Wolfgang Dressler. 1986. Métathèse et conversion morphologiques en arabe tunisien. *Zeitschrift für Phonetik, Sprachwissenschaft und Kommunikationsforschung* 39(1). 61–75.
- Kiparsky, Paul. 1973. Phonological representations. In Osamu Fujimura (ed.), *Three dimensions of linguistic theory*, 1–136. Tokyo: TEC.
- Kleian, E. F. 1894. Lijst van woorden in het Maleisch, Hollandsch, Rottineesch en Timoreesch. *Tijdschrift voor Indische Taal-, Land- en Volkenkunde* 37. 209–284.
- Kurusu, Kazutaka. 2001. *The phonology of morpheme realization*. UC Santa Cruz. (Doctoral dissertation).
- Lambrecht, Knud. 1994. *Information structure and sentence form: Topic, focus, and the mental representations of discourse referents*. Cambridge: Cambridge University Press.
- Lehmann, Christian. 1988. Towards a typology of clause linkage. In John Haiman & Sandra A. Thompson (eds.), *Clause combining in grammar and discourse*, 181–225. Amsterdam: John Benjamins.
- Liddicoat, Anthony J. 2007. *An introduction to conversation analysis*. London: Continuum.
- Lindblom, Björn. 1986. Phonetic universals in vowel systems. In John J. Ohala & Jeri J. Jaeger (eds.), *Experimental phonology*, 13–44. Orlando: Academic Press.
- Longacre, Robert E. 1983. *The grammar of discourse*. New York: Plenum Press.
- Marlett, Stephen & Joseph Stemberger. 1983. Empty consonants in Seri. *Linguistic Inquiry* 14. 617–639.
- Matthews, P. H. 1974. *Morphology: An introduction to the theory of word structure*. Cambridge: Cambridge University Press.
- McCarthy, John. 1981. A prosodic theory of nonconcatenative morphology. *Linguistic Inquiry* 12(3). 373–418.

## References

- McCarthy, John. 2000. The prosody of phase in Rotuman. *Natural Language & Linguistic Theory* 18(1). 147–197.
- McCarthy, John & Alan Prince. 1990. Foot and word in prosodic morphology: The Arabic broken plural. *Natural Language & Linguistic Theory* 8(2). 209–283.
- McCarthy, John & Alan Prince. 1993a. Generalized alignment. In Geert Booij & Jaap van Marle (eds.), *Yearbook of morphology 1993*, 79–153. Dordrecht: Springer.
- McCarthy, John & Alan Prince. 1993b. Prosodic morphology I: Constraint interaction and satisfaction. Rutgers Optimality Archive 482.
- McConvell, Patrick & Clemens Kolo. 1996. *Metathesis and the complete/incomplete forms of pronominal proclitics in Dawan (West Timor)*. Paper presented at the 26th Australian Linguistic Society Conference, Canberra, July 6–7.
- McWilliam, Andrew. 2002. *Paths of origin, gates of life: A study of place and precedence in southwest Timor*. Leiden: KITLV Press.
- Mel'čuk, Igor. 1997. *Cours de morphologie générale: Cinquième partie : Signes morphologiques*. Montréal: Presses de l'Université de Montréal.
- Metboki, Yakob & Kate Bellamy. 2014. Expressions of quantity in the Amanuban dialect of Uab Meto. In Marian Klamer & František Kratochvíl (eds.), *Number and quantity in East Nusantara*, vol. 1 (Papers from 12-ICAL), 60–78. Canberra: Asia-Pacific Linguistics. <http://pacling.anu.edu.au/materials/SAL/APL012-SAL001.pdf>.
- Middelkoop, Pieter. 1939. *Amarassische-Timoreesche teksten*. Bandung: Verhandelingen van het Bataviaasch Genootschap voor Kunsten en Wetenschappen 74(2).
- Middelkoop, Pieter. 1949. *Een studie van het Timoreesche doodenritueel*. Vol. 76 (Verhandelingen van het Bataviaasch Genootschap van Kunsten en Wetenschappen). Bandung: A. C. Nix & Co.
- Middelkoop, Pieter. 1950. Proeve van een Timorese grammatica. *Bijdragen tot de Taal-, Land- en Volkenkunde* 106. 375–517.
- Middelkoop, Pieter. 1972. Nederlands-Timorees woordenboek. MS.
- Mills, Roger. 1991. Tanimbar-Kei: An eastern Indonesian subgroup. In Robert Blust (ed.), *Currents in Pacific linguistics: Papers on Austronesian languages and ethnolinguistics in honour of George W. Grace*, 241–263. Canberra: Pacific Linguistics. C-117.
- Milroy, Lesley. 1982. Language and group identity. *Journal of Multilingual and Multicultural Development* 3. 207–216.
- Miret, Fernando. 1998. Some reflections on the notion of diphthong. *Papers and studies in contrastive linguistics* 34. 27–51.

- Montler, Timothy. 1986. *An outline of the morphology and phonology of Saanich* (Occasional Papers in Linguistics 4). Missoula: Linguistics Laboratory, University of Montana. <http://www.cas.unt.edu/~montler/Saanich/Outline/>.
- Montler, Timothy. 1989. Infixation, reduplication, and metathesis in the Saanich actual aspect. *Southwest Journal of Linguistics* 9(1). 92–107.
- Morris, Cliff. 1984. *Tetun - English dictionary*. Canberra: Pacific Linguistics. C-83.
- Mous, Maarten. 1993. *A grammar of Iraqw*. Hamburg: Helmut Buske.
- Müller, Salomon. 1857. *Reizen en onderzoekingen in den Indischen Archipel*. Vol. 2. Amsterdam: Frederik Muller.
- Okrand, Marc. 1977. *Mutsun grammar*. University of Berkeley. (Doctoral dissertation).
- Okrand, Marc. 1979. Metathesis in Costanoan grammar. *International Journal of American Linguistics* 45(2). 123–130.
- Ora, Yedida. 2016a. *Abka'u es, kaan ee bi paniki*. Charles E. Grimes, Heronimus Bani & Owen Edwards (eds.) (UBB Buku Besar TK/1-04). Kupang: Language & Culture Unit (UBB). [Early grade BB reader: “A bat named Miss Paniki”].
- Ora, Yedida. 2016b. *Hit ttoit makasi teu uisneno*. Charles E. Grimes, Heronimus Bani & Owen Edwards (eds.) (UBB Buku Besar TK/1-05). Kupang: Language & Culture Unit (UBB). [Early grade BB reader: “We give thanks to God”].
- Ora, Yedida. 2016c. *Nai' pe'u nabarab he nnao on askoor*. Charles E. Grimes, Heronimus Bani & Owen Edwards (eds.) (UBB Buku Besar TK/1-01). Kupang: Language & Culture Unit (UBB). [Early grade BB reader: “Pete gets ready to go to school”].
- Prince, Alan. 1980. A metrical theory for estonian quantity. *Linguistic Inquiry* 11. 511–562.
- Prince, Alan & Paul Smolensky. 1993/2002. *Optimality theory: Constraint interaction in generative grammar*. Rutgers Optimality Archive Version, 8/2002.
- Rießler, Michael. 2016. *Adjective attribution*. Berlin: Language Science Press.
- Ross, Malcolm. 1995. Some current issues in Austronesian linguistics. In Darrell Tryon (ed.), *Comparative Austronesian dictionary*, 45–120. Berlin: Mouton de Gruyter.
- Schapper, Antoinette. 2009. *Bunaq: A Papuan language of central Timor*. Australian National University. (Doctoral dissertation).
- Schapper, Antoinette. 2015. Wallacea, a linguistic area. *Archipel* 90. 99–151.
- Schapper, Antoinette & Rachel Hendery. 2014. Wersing. In Antoinette Schapper (ed.), *Papuan languages of Timor, Alor and Pantar*, vol. 1, 439–503. Berlin: Mouton de Gruyter.

## References

- Schegloff, Emanuel A. & Harvey Sacks. 1977. Opening up closings. *Semiotica* 7. 289–327.
- Schulte Nordholt, H. G. 1971. *The political system of the Atoni of Timor*. The Hague: Martinus Nijhoff. Translation of *Het Politieke Systeem van de Atoni van Timor (1966)*.
- Simons, Gary. 1977. A Kwara'ae spelling list. In *Working papers for the language variation and limits to communication project*. Cornell University & Summer Institute of Linguistics.
- Sohn, Ho-min. 1980. Metathesis in Kwara'ae. *Lingua* 52. 305–323.
- Steinhauer, Hein. 1993. Notes on verbs in Dawanese. In Ger Reesnik (ed.), *Topics in descriptive Austronesian linguistics*, 130–158. Leiden: Vakgroep Talen en Culturen van Zuidoost-Azië en Oceanië.
- Steinhauer, Hein. 1996a. Morphemic metathesis in Dawanese (Timor). In Hein Steinhauer (ed.), *Papers in Austronesian linguistics no. 3*, 217–232. Canberra: Pacific Linguistics. A-84.
- Steinhauer, Hein. 1996b. Synchronic metathesis and apocope in three Austronesian languages of the Timor area. In Suwilai Premasri (ed.), *Pan-Asiatic linguistics; proceedings on the fourth international symposium on language and linguistics, 8-10 January*, vol. 2, 471–492. Thailand: Institute of Language & Culture for Rural Development, Mahidol University.
- Steinhauer, Hein. 2008. Synchronic metathesis and apocope in three Austronesian languages of the Timor area. In Yury A. Lander & Alexander K. Ogloblin (eds.), *Language and text in the Austronesian world: Studies in honour of ülo Sirk*, 277–296. Munich: Lincom Europa.
- Steven, Lee Anthony. 1991. *The phonology of Roma, an Austronesian language of eastern Indonesia*. The University of Texas at Arlington. (MA thesis).
- Stonham, John. 1994. *Combinatorial morphology*. Amsterdam & Philadelphia: John Benjamins.
- Stump, Gregory T. 2001. *Inflectional morphology: A theory of paradigm structure*. Cambridge: Cambridge University Press.
- Taber, Kathleen B. & Mark Taber. 2015. *Luang grammar and phonology sketch*. SIL International. SIL eBook 63.
- Talul, Ludofikus. 1988. *A morphemic analysis of the Sainoni, a subdialect of Miomaffo of the Dawan language spoken in the regency of north central Timor*. Widya Mandira Catholic University. (MA thesis).
- Tamelan, Thersia. 2007. *An overview of Dela-Oenale verb morphology: A language spoken in western Rote*. Paper presented at the 5th International East Nusantara Conference on Language and Culture, Kupang, Indonesia, August 1–3.

- Tarno, Wakidi, S. J. Mboeik, P. Sawardo & S. Kushyaryanto. 1989. *Tata bahasa dawan*. Jakarta: Pusat Pembinaan dan Pengembangan Bahasa, Departemen Pendidikan dan Kebudayaan.
- Thompson, Laurence & M. Terry Thompson. 1969. Metathesis as a grammatical device. *International Journal of American Linguistics* 35(3). 213–219.
- Thráinsson, Höskuldur, Hjalmar P. Petersen, Jógvan í Lon Jacobsen & Zakaris Svabo Hansen. 2004. *Faroese: An overview and reference grammar*. Tórshavn: Føroya Fróðskaparfelag.
- Tryon, Darrell & B. Hackman. 1983. *Solomon Islands: An internal classification*. Canberra: Pacific Linguistics. C-72.
- Unit Bahasa & Budaya. 2015. *Uisneno in kabin ma prenatal: Rais manba'an fe'u nok reta' ahun-hunut*. Kupang: Unit Bahasa & Budaya in cooperation with Wycliffe Bible Translators. 1262 + xx pages. [God's Message: New Testament with Genesis in the Amarasi language.]
- Unit Bahasa & Budaya. 2018. *Usif Yesus In tu'in alekot natuin nai Markus in lulat*. Kupang, Indonesia: Unit Bahasa & Budaya in cooperation with Wycliffe Bible Translators. [The Lord Jesus' Good News according to Mark's writing in the Amfo'an language].
- Urbanczyk, Suzanne. 2011. Evidence from Halkomelem for word-based morphology. In John Lyon & Joel Dunham (eds.), *UBC working papers in linguistics*, vol. 30, 470–489.
- Vamarasi, Marit. 2002. *Rotuman*. Munich: Lincom Europa.
- van den Berg, René. 2012. Elusive articles in Sulawesi: Between syntax and prosody. In Niclas Burenhult, Arthur Holmer, Anastasia Karlsson, Håkan Lundström & Jan-Olof Svantesson (eds.), *Language documentation and description, vol 10: Special issue on humanities of the lesser-known: New directions in the description, documentation and typology of endangered languages and music*, 208–227. London: SOAS.
- van der Hulst, Harry & Aone van Engelenhoven. 1995. Metathesis effects in Leti. In Harry van der Hulst & Jeroen van de Weijer (eds.), *Leiden in last; papers from the first HIL conference on phonology*, 243–67. Holland Academic Press.
- van Engelenhoven, Aone. 1994. Indexing the evidence: Metathesis and subordination in Leti (Eastern-Indonesia). In Cecilia Odé & Wim Stokhof (eds.), *Proceedings of the seventh international conference on Austronesian linguistics*, 257–276. Leiden: Leiden University.
- van Engelenhoven, Aone. 1996. Metathesis and the quest for definiteness in the Leti of Tutukei (East-Indonesia). In Hein Steinhauer (ed.), *Papers in Austronesian linguistics no. 3*, 207–215. Canberra: Pacific Linguistics. A-84.

*Name index*

- van Engelenhoven, Aone. 2004. *Leti, a language of Southwest Maluku*. Leiden: KITLV Press.
- Watson-Gegeo, Karen & David Gegeo. 1986. Calling-out and repeating routines in Kwara'ae children's language socialization. In Bambi Schieffelin & Elinor Ochs (eds.), *Language socialization across cultures*, 17–50. Cambridge: Cambridge University Press.
- Wiese, Richard. 1996. *The phonology of German*. Oxford: Oxford University Press.
- Williams-van Klinken, Catharina & Rob Williams. 2015. *Mapping the mother tongue in timor-leste: Who spoke what where in 2010?* Dili: Dili Institute of Technology. <http://www.tetundit.tl/TimorLang.html>. [Accessed 30/04/2015].
- Windschuttel, Glenn & Asako Shiohara. 2017. Kui. In Antoinette Schapper (ed.), *Papuan languages of Timor, Alor and Pantar*, vol. 2, 109–183. Berlin: Mouton de Gruyter.
- Wolff, John U. 2010. *Proto-Austronesian phonology with glossary*. Ithaca, NY: Cornell Southeast Asia Program Publications.
- Zorc, R. David Paul. 1978. *Functor analysis: A method of quantifying function words for comparing and classifying languages*. Hornbeam Press: Columbia. Paper presented at Fifth LACUS Forum.



# Name index

- Adelaar, Alexander, 7  
Aikhenvald, Alexandra Y., 311, 313, 314  
Anderson, Cormac, 133  
Anderson, Stephen, 17, 175, 176, 182
- Balle, Misriani, 68–75  
Banamtuan, Johnny M., 44–46  
Bani, Heronimus, 418  
Bates, Dawn, 82  
Bellamy, Kate, 11  
Besnier, Niko, 2, 34–36, 38–40, 185  
Blanco, A. Lacayo, 20  
Blevins, Juliette, 28, 31, 32, 79, 80, 82, 83, 88, 141, 167, 194, 200, 416, 471  
Blust, Robert, 6, 7, 67, 80, 129, 134, 144, 240, 447, 455  
Bowden, John, 142  
Bresnan, Joan, 271  
Brockhaus, Wiebke, 21  
Buckley, Eugene, 25, 26, 466, 467
- Cameron, Stuart, 68, 69, 71–75  
Capell, Arthur, 10  
Churchward, Clerk Maxwell, 1, 19, 34–41, 43, 83, 184, 185, 190  
Clements, George, 105, 133  
Comrie, Bernard, 270  
Coward, David, 23, 24  
Coward, Naomi, 23, 24  
Cowell, Mark W., 86
- Culhane, Kirsten, 11, 130, 199, 224, 225, 421, 423  
Cunningham, Clark E., 417, 433, 434
- de Vaan, Michiel, 19  
Demers, Richard A., 81, 82, 470  
Donohue, Mark, 7, 142, 143, 258  
Dooley, Robert, 342  
Dressler, Wolfgang, 460–462  
Dryer, Matthew S., 12  
Durand, Jacques, 105
- Edwards, John, 417  
Edwards, Owen, 7, 15, 68, 120, 121, 133, 142, 145, 149, 210, 252
- Fishman, Joshua A., 417  
Fogaça, Helem Andressa de Oliveira, 61, 63, 65, 66  
Fox, James J., 346, 380, 426, 431, 433, 436  
Freeland, L. S., 464–466
- García, Ofelia, 417  
Garrett, Andrew, 28, 31, 32, 79, 80, 82, 83, 88, 167, 194, 200, 416, 471  
Gegeo, David, 32, 33  
Goldsmith, John, 1, 17, 175, 182, 221  
Gordon, E. V., 77, 78  
Grace, George, 83  
Grimes, Charles E., 7, 11, 18, 61, 62, 64, 142, 315, 316, 346, 383, 418, 448, 449

*Name index*

- Hackman, B., 31  
Hajek, John, 142  
Hale, Kenneth, 20  
Hale, Mark, 39–42, 83, 183, 185  
Harbert, Wayne, 77  
Hayes, Bruce, 110  
Heider, Paul M., 12  
Heinz, Jeffrey, 2, 28–33, 183, 184, 187–189, 415  
Hendery, Rachel, 44  
Himmelmann, Nikolaus P., 142, 326  
Hólmarsson, Sverrir, 78, 79  
Hukari, Thomas, 472, 473  
Hume, Elizabeth, 2, 22, 51
- Isu, Rudolof Jibrael, 11  
Itô, Junko, 211
- Jacob, June, 11, 315, 316  
Jonker, J. C. G., 10, 144
- Kaufman, Daniel, 326  
Kawachi, Kazuhiro, 23  
Kenstowicz, Michael, 165  
Keyser, Samuel, 105, 133  
Kilani-Schoch, Marianne, 460–462  
Kiparsky, Paul, 165  
Kisseberth, Charles, 165  
Kissock, Madelyn, 39–42, 83, 183, 185  
Kleian, E. F., 10  
Kolo, Clemens, 167, 183, 192  
Kurusu, Kazutaka, 202
- Lambrecht, Knud, 264  
Lehmann, Christian, 354  
Levinsohn, Stephen H., 342  
Liddicoat, Anthony J., 393  
Lindblom, Björn, 137  
Longacre, Robert E., 361
- Marlett, Stephen, 133, 219  
Matthews, P. H., 17, 175, 182  
McCarthy, John, 20, 41, 110, 118, 183–190, 192, 215  
McConvell, Patrick, 167, 183, 192  
McWilliam, Andrew, 431, 432  
Mel'čuk, Igor, 462  
Mester, Armin, 211  
Metboki, Yakob, 11  
Middelkoop, Pieter, 10, 104, 143  
Mills, Roger, 24  
Milroy, Lesley, 417  
Miret, Fernando, 137  
Montler, Timothy, 468, 469  
Morris, Cliff, 455  
Mous, Maarten, 87  
Müller, Salomon, 10
- Okrand, Marc, 462–464  
Ora, Yedida, 12, 237, 246
- Peter, Ruby, 473  
Prince, Alan, 20, 110, 118, 183, 184, 215
- Rießler, Michael, 88  
Ross, Malcolm, 7
- Sacks, Harvey, 392  
Schapper, Antoinette, 7, 27, 44, 47, 48  
Schegloff, Emanuel A., 392  
Schulte Nordholt, H. G., 417, 424, 430–433  
Seo, Misun, 2, 22  
Shiohara, Asako, 21  
Simons, Gary, 31  
Smolensky, Paul, 118, 184, 215  
Sohn, Ho-min, 28–32  
Steinhauer, Hein, 10, 68, 69, 71–73, 93, 120, 152, 167

- Stemberger, Joseph, 133, 219  
Steven, Lee Anthony, 49, 58–60  
Stonham, John, 192  
Stump, Gregory T., 17
- Taber, Kathleen B., 48–50, 183, 190,  
415  
Taber, Mark, 48–50, 183, 190, 415  
Talul, Ludofikus, 10, 11  
Tamelan, Thersia, 142  
Tarno, Wakidi, 11  
Thompson, Laurence, 467, 470, 471  
Thompson, M. Terry, 467, 470, 471  
Thráinsson, Höskuldur, 22  
Trussel, Stephen, 67, 80, 129, 134, 144,  
240, 455  
Tryon, Darrell, 31
- Urbanczyk, Suzanne, 472, 473
- Vamarasi, Marit, 34–38, 40, 41, 185  
van den Berg, René, 87  
van der Hulst, Harry, 2, 51  
van Engelenhoven, Aone, 2, 51–54, 56,  
57
- Watson-Gegeo, Karen, 32, 33  
Wiese, Richard, 21, 22, 25, 179  
Williams, Rob, 5  
Williams-van Klinken, Catharina, 5  
Windschuttel, Glenn, 21  
Wolff, John U., 240
- Zorc, R. David Paul, 18



# Language index

Alsea, 25, 26

Bunak, 27, 46–48, 85

Dela, 120<sup>9</sup>, 419

Dengka, 133, 260

Dhao, 142, 142<sup>25</sup>

Dutch, 10, 19, 100, 105, 144, 147, 147<sup>31</sup>,  
147<sup>32</sup>, 236, 274, 275<sup>8</sup>, 407<sup>17</sup>

English, 15, 16, 19, 26, 33, 77, 86, 102,  
104, 128, 161, 272, 361, 373,  
379, 385, 393, 406<sup>16</sup>

Faroese, 22, 26

Finnish, 133

Fordata, 24

French, 37<sup>5</sup>

German, 6, 19, 21, 21<sup>2</sup>, 22, 24–26, 37<sup>5</sup>,  
179

Hawu, 142, 142<sup>25</sup>

Helong, 26, 27, 44, 68<sup>17</sup>, 68<sup>17</sup>, 68<sup>17</sup>, 68<sup>17</sup>,  
75<sup>18</sup>, 68–77, 83, 85, 86, 150,  
165, 200, 415, 417, 419, 425

Icelandic, 78, 79

Iraqw, 87

Irish, 133

Kemak, 7

Klallam, 81, 82, 82<sup>20</sup>

Kwara'ae, 27–29, 31–34, 37, 82, 85, 89,  
108, 183, 184, 187, 188, 415,  
416

Leti, 51–58

Luang, 24, 28, 48–50, 50, 51, 58, 85,  
183, 190, 415

Lummi, 81, 82

Lushootseed, 82<sup>20</sup>

Mambae, 7, 26, 27, 50, 66<sup>12</sup>, 66<sup>14</sup>, 67<sup>16</sup>,  
60–69, 76, 83, 85, 165, 200,  
415

Meto

Amabi, 7<sup>4</sup>, 8, 98, 419<sup>2</sup>

Amanuban, 10–12, 128, 132, 143,  
164, 168, 196, 196<sup>15</sup>, 197, 198,  
235<sup>6</sup>, 248, 249, 249<sup>17</sup>, 250, 251,  
251<sup>20</sup>, 252, 419–422, 431

Amfo'an, 5<sup>2</sup>, 7, 10–12, 93<sup>3</sup>, 129,  
130, 130<sup>13</sup>, 131, 131<sup>15</sup>, 131<sup>16</sup>, 134,  
166–168, 171, 196, 196<sup>14</sup>, 198,  
199<sup>16</sup>, 224, 225, 270<sup>6</sup>, 417, 419–  
421, 423, 424

Baikeno, 12, 129, 129<sup>11</sup>, 130, 131,  
150<sup>34</sup>, 164, 166, 168, 236<sup>7</sup>, 270<sup>6</sup>,  
419, 420

Biboki, 150<sup>34</sup>

Fatule'u, 12, 128, 131, 168, 196, 196<sup>14</sup>,  
417–421

Insana, 150<sup>34</sup>, 192<sup>13</sup>, 424, 432

Ketun, 6<sup>3</sup>, 12, 168

*Language index*

- Kopas, 6<sup>3</sup>, 12, 131, 166, 168, 196,  
419–421
- Kusa-Manea, 6<sup>3</sup>, 7<sup>4</sup>, 12, 128, 146,  
165, 167, 168, 173, 419, 419<sup>2</sup>
- Miomafo, 10, 11, 93<sup>3</sup>, 120, 150<sup>34</sup>,  
152, 164, 166, 167, 192<sup>13</sup>
- Molo, 10, 143, 143<sup>27</sup>, 168, 419
- Ro'is Amarasi, 4, 7, 8, 11, 98, 127,  
137, 138<sup>21</sup>, 143, 145, 166, 169,  
171, 181, 181<sup>4</sup>, 182, 194, 195,  
199, 200, 206, 250–252, 261<sup>2</sup>,  
270<sup>6</sup>, 337, 338, 407–409, 411,  
412, 412<sup>19</sup>, 419, 420, 423
- Timaus, 5<sup>2</sup>, 6<sup>3</sup>, 7<sup>4</sup>, 12, 131, 131<sup>15</sup>,  
131<sup>16</sup>, 131<sup>17</sup>, 132, 132<sup>18</sup>, 166,  
168, 181<sup>4</sup>, 196, 196<sup>14</sup>, 198, 419,  
419<sup>2</sup>, 420, 421, 423, 424
- Old Norse, 77, 78, 78<sup>19</sup>, 79, 86
- Roma, 24, 27, 49<sup>8</sup>, 58–60, 72, 85, 87,  
102, 318, 333, 356, 415
- Rotuman, 1, 19, 20, 26–28, 34–39, 42,  
43, 44, 56, 57, 72, 77, 82, 83,  
85, 86, 88, 89, 183–190, 192,  
283, 415
- Saanich, 81
- Selaru, 23, 26, 49, 53, 58
- Seri, 133, 219
- Sidamo, 22, 23, 26
- Syrian Arabic, 86, 88
- Termanu, 10, 133, 144, 259
- Tetun, 6<sup>3</sup>, 7<sup>4</sup>, 417, 419, 425
- Tolaki, 87, 87<sup>22</sup>, 88
- Turkish, 133
- Ulwa, 19, 19<sup>1</sup>, 20, 21
- Waima'a, 142, 142<sup>26</sup>
- Wersing, 27, 44–46, 46<sup>7</sup>, 85
- Yamdena, 24



# Did you like this book?

This book was brought to you for free

Please help us in providing free access to linguistic research worldwide. Visit <http://www.langsci-press.org/donate> to provide financial support or register as a community proofreader or typesetter at <http://www.langsci-press.org/register>.

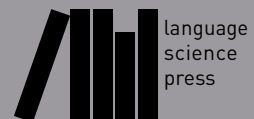





# Metathesis and unmetathesis in Amarasi

This book provides a complete analysis of synchronic CV → VC metathesis in Amarasi, a language of western Timor. Metathesis and unmetathesis realise a paradigm of parallel forms, pairs of which occur to complement each other throughout the language.

Metathesis in Amarasi is superficially associated with a bewildering array of disparate phonological processes including: vowel deletion, consonant deletion, consonant insertion and multiple kinds of vowel assimilation, any of which can (and do) vary by lect in their realisation. By proposing that Amarasi has an obligatory CVCVC foot in which C-slots can be empty, all these phonological processes can be straightforwardly derived from a single rule of metathesis and two associated phonological rules.

Three kinds of metathesis can be identified in Amarasi: (i) Before vowel initial enclitics, roots must undergo metathesis, responding to the need to create a phonological boundary between a clitic host and enclitic. Such metathesis is phonologically conditioned. (ii) Metathesis occurs within the syntax to signal attributive modification. Such a metathesised form cannot occur at the end of a phrase and thus requires the presence of an unmetathesised form to complete it syntactically. (iii) In the discourse an unmetathesised form marks an unresolved event or situation. Such an unmetathesised form cannot occur in isolation and requires a metathesised form to achieve resolution.

Metathesis in Amarasi is the central linguistic process around which linguistic structures are organised. Amarasi metatheses also reflect fundamental Timorese notions of societal and cosmic organisation. Alongside weaving and other performed activities, metathesis is an important linguistic marker of identity in a region obsessed with similarities and differences between different groups. The complementarity of Amarasi metathesis and unmetathesis within the syntax and within discourse reflects the Timorese division of the world into a series of mutually dependent binary and complementary pairs. As well as being the key which unlocks the structure of the language, metathesis is also a reflection of the structure of Amarasi society and culture.

ISBN 978-3-96110-222-8



9 783961 102228