



Universiteit
Leiden
The Netherlands

T-CYCLE EPR Development at 275 GHz for the study of reaction kinetics & intermediates

Panarelli, E.G.

Citation

Panarelli, E. G. (2018, December 10). *T-CYCLE EPR Development at 275 GHz for the study of reaction kinetics & intermediates*. *Casimir PhD Series*. Retrieved from <https://hdl.handle.net/1887/68233>

Version: Not Applicable (or Unknown)

License: [Licence agreement concerning inclusion of doctoral thesis in the Institutional Repository of the University of Leiden](#)

Downloaded from: <https://hdl.handle.net/1887/68233>

Note: To cite this publication please use the final published version (if applicable).

Cover Page



Universiteit Leiden



The handle <http://hdl.handle.net/1887/68233> holds various files of this Leiden University dissertation.

Author: Panarelli, E.G.

Title: T-CYCLE EPR Development at 275 GHz for the study of reaction kinetics & intermediates

Issue Date: 2018-12-10

3

**Temperature-Cycle EPR: A novel
method for the investigation of
chemical dynamics**

3.1 Introduction

Investigating intermediates and kinetics of chemical reactions is essential to understand the function and mechanism of many (bio)molecular processes, from enzymatic catalysis to polymer degradation. However, given the short time scales on which most chemical systems react, and the even shorter time scales on which their intermediates exist, kinetic measurements are not an easy task.

It is often the case in molecular systems of biological importance that the reaction intermediates involved are paramagnetic species, for whose investigation the most suitable technique is Electron Paramagnetic Resonance (EPR) [46] [12].

The research idea of this Chapter is therefore that of finding a method that enables EPR investigations of chemical kinetics. The method should be flexible and versatile enough, so as to be applicable to a wide range of molecular systems, and on time scales down to milliseconds.

Flow methods, such as the stopped- and continuous-flow ones, where the reaction of two components is followed after they have been rapidly mixed, have extensively been employed to study chemical kinetics down to several milliseconds and tens of microseconds [47] [48]. They are of great importance because they offer high time resolution and quantitative applications in EPR [49], and they allow continuous detection of the kinetics of molecular systems. However, such methods require large volumes of reactants, which is disadvantageous when having to do with biological materials.

Rapid Freeze-Quench (RFQ) is another well-established, standard technique to investigate chemical kinetics with a time resolution of milliseconds down to microseconds [35] [38] [20]. However, as described in Chapter 2 of this thesis, this method suffers from a few drawbacks, such as the large amount of material required, a low reproducibility due to the number of different samples needed, and the inefficient sample packing for applications in EPR.

It is thus desirable to turn to alternative methods to investigate (bio)molecular dynamics, ideally allowing high time resolution, need of little amount of material, and versatility of application.

The idea of producing temperature jumps (T-jumps) directly on the system under study was first put forward by Eigen and coworkers in 1963, who devised a method to induce a T-jump via an electrical discharge of a high-voltage capacitor through a conductive solution [22], and thus also called "Joule heating". To date still commercially available [23], this method has been extensively used in various fields, from biophysics [50] [51] to inorganic chemistry [52] [53], and has been coupled to several detection techniques, mainly optical spectroscopies such as fluorescence spectroscopy [54]. The Joule-heating technique makes it possible to achieve a time

3. T-CYCLE EPR FOR THE INVESTIGATION OF CHEMICAL DYNAMICS

resolution down to microseconds, but only when T-jumps of a few degrees are applied; this is a clear limitation of the method, as an increase of the extent of the T-jumps implies significantly longer heating pulses. Furthermore, since the solution medium being conductive calls for high concentrations of electrolytes added to it, applications of the Joule heating method are limited to polar solvents.

With the advent of pulsed lasers, dramatically shorter time scales were reached in biophysics (from milliseconds down to nanoseconds), thanks to the high time resolution offered by the pulsed-laser technologies.

Upon light excitation of dye molecules added to the system or, more universally, of the solvent molecules, heat release follows, and the system is then subject to a temperature-increasing T-jump. Particularly for aqueous solutions, excitation of the overtone of the OH stretching band of water molecules is possible upon intense irradiation with near-infrared light between 1300 and 2100 nm [55].

The first attempts of laser-induced T-jump experiments date back to the 1960s, with T-jumps between 0.1 and 10 °C in microliter-size volumes of aqueous solutions with IR or visible laser pulses of the length of tens of nanoseconds [56] [57] [58].

Since their introduction, laser-induced T-jump methodologies have found biophysical applications in the study, for instance, of the folding of peptides, proteins, and nucleotides [59] [60] [61] [62], of the dynamics of enzymatic reactions [63], and of protein-nucleic acid interactions [64].

The presence of a large body of well-established T-jump methodologies applied to the study of (bio)molecular dynamics, together with the importance of EPR as a unique tool in biophysical and biochemical investigations, were the starting points in the design of a method that couples laser-induced T-jumps to EPR for the study of chemical kinetics.

This Chapter describes the implementation of *Temperature-Cycle EPR* (abbreviated as T-Cycle EPR), a novel high-frequency EPR technique that couples laser-induced T-jumps to a home-built 275 GHz EPR spectrometer to explore short-lived intermediates and kinetics of chemical reactions in aqueous solutions involving paramagnetic species. The reason for a method with high-frequency EPR (HF-EPR) is that it offers high spectral resolution and, if coupled to single-mode cavities, high sensitivity [34] [65].

The minuscule resonant volume (20 nL) of the single-mode cavity of our 275 GHz EPR spectrometer [34] can be advantageously exploited to heat *in situ* a mixture of reactants, initially at a temperature where no reaction occurs, by means of an IR-laser-induced T-jump, in a homogeneous, reproducible, and controllable manner. This *in-situ* T-jump increases the temperature

of the mixture (controlled by a cryostat) to a temperature at which the reaction takes place for an arbitrary period of time. The application of a sequence – or *cycle* – of T-jumps to the frozen mixture thus lets the molecular reaction under study unfold, the paramagnetic species involved being depleted (in the case of reactants) or being formed (in the case of intermediates or products), and a kinetic study of the chemical system is possible.

3.2 Temperature-Cycle EPR

To give a simple illustration of the working of T-Cycle EPR, its application to a mixture of two reagents, sitting at a temperature where no reaction occurs, is considered. The bottom part of Figure 3.1 schematically illustrates a sequence of T-Cycle *steps* applied on the aforesaid mixture (note that what is referred to as T-Cycle is the ensemble of all such steps). Upon application of each T-Cycle step, the reaction has progressed by a time amount in principle defined by the duration of the laser-induced T-jump associated to the T-Cycle step. The reactants are thus depleted and, in the case where at least one of the two is paramagnetic, their EPR signal decreases over time. This is depicted in a simplified way in the upper part of Figure 3.1, with a model intensity decay of the EPR signal of one of the two reactants as a function of time.

The whole kinetics of a reaction, or the evolution of paramagnetic intermediate species, can thus be studied from one single sample, as the laser-induced T-jumps are applied *in situ* directly into the spectrometer's cavity where the sample is located.

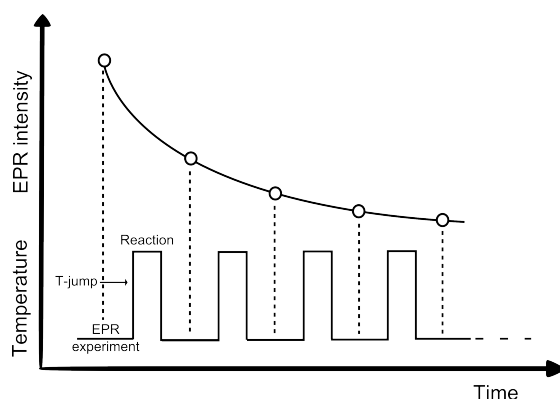

Figure 3.1: Scheme of a Temperature-Cycle experiment.

Each step of a T-Cycle experiment can be viewed as composed of five parts, involving up to

3. T-CYCLE EPR FOR THE INVESTIGATION OF CHEMICAL DYNAMICS

three different temperatures, namely a *Measurement Temperature*, a *Preparation Temperature*, and a *Reaction Temperature*. Figure 3.2 schematically represents the three temperatures and the parts a T-Cycle step is composed of:

- (A) A mixture of reactants sits at an arbitrary *Measurement Temperature*, namely a temperature at which no reaction occurs, and which is suitable to perform a desired EPR experiment. It can be arbitrarily low (i.e., as low as a He-flow cryostat allows), and thus be suitable for all those EPR experiments that require cryogenic temperatures.
- (B) The non-reacting mixture is taken to a higher temperature, called *Preparation Temperature*, still low enough for the sample not to undergo any reaction, but high enough to apply a T-jump to temperatures at which the reaction takes place.
- (C) An IR-laser-induced T-jump of arbitrary time length and power is applied. During this time the sample reaches a temperature defined as *Reaction Temperature*, where the reaction occurs for the specific time length.
- (D) When the IR-heating is turned off, the sample's temperature drops back to the *Preparation Temperature*, which prevents the reaction to go further.
- (E) The sample can be taken again to the *Measurement Temperature*, where the next EPR spectrum can be recorded.

Both the Measurement Temperature and the Preparation Temperature are regulated by a cryostat.

The Temperature-Cycle method was implemented on a home-built 275 GHz EPR spectrometer, whose insert is wired with a multimode optical fiber that couples the cavity with an infrared diode laser operating at 1550 nm (details are provided in Subsection 3.3.2). This wavelength is absorbed by the solvent water molecules [55], which release heat upon relaxation, causing an aqueous solution in the cavity to warm up (the solution may or may not be frozen). The laser's light is not focused and is shone through the lower, grid-like part of the brass cavity, so that a scattering of the light is produced and the laser hits the sample directly in the cavity.

The thermal diffusivity of the solvent and of the sample holder in contact with it is one of the factors limiting how fast a determined volume of solution reaches a certain temperature when subjected to a laser-induced T-jump [23]. It follows that, associated to any T-jump, there always are a rise time and a fall time, determined by the physical properties of the solvent and of the

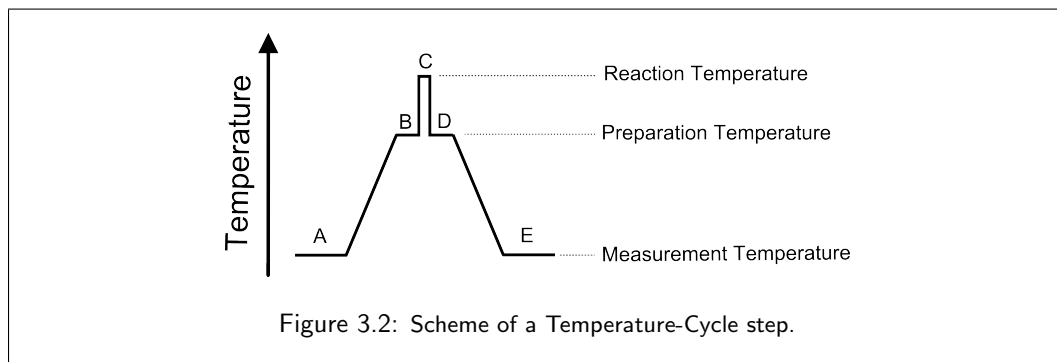

Figure 3.2: Scheme of a Temperature-Cycle step.

sample-holder. In order to achieve a picture of the time scales of the rise and fall time involved in a laser-induced T-jump event, the 275 GHz EPR intensity variations of a TEMPONE solution in a mixture of water and glycerol were recorded as a function of time, while periodically heating the solution with laser pulses to induce T-jumps. TEMPONE is a nitroxide radical structurally and chemically similar to TEMPOL, with the difference that the former has a 4-oxo moiety instead of a 4-hydroxyl one. A solution of TEMPONE in water and glycerol acts as a sort of thermometer to characterize the T-jumps, because the high-frequency EPR intensity variations of this system are closely associated to a change in temperature. Figure 3.3 shows the averaged time profile of a TEMPONE solution, and provides some experimental details. Upon applying a laser pulse of the duration of 1200 ms at a power of 3.5 W, a rise time of at least 300 ms and a fall time of at least 500 ms can be deduced. This affects the time the system spends at the equilibrium temperature reached with the T-jump, and obviously becomes more and more important to take into account as the duration of the laser pulse becomes shorter. An analysis of the temperatures that are possible to reach upon application of a laser-induced T-jump is provided in the Appendix to this Chapter, and constitutes a novel method following the premises cast in the work published by Azarkh and Groenen [24].

3.3 Experimental

3.3.1 Materials

The mixtures of 4-hydroxy-TEMPO, also known as TEMPOL (Sigma-Aldrich, cat. n. 176141), and L(+)-ascorbic acid (Carl Roth, cat. n. 3525.1) used for the T-Cycle experiments described in this Chapter were prepared from batch solutions at concentrations of 4 mM (TEMPOL) and 2 mM (ascorbic acid), in a mixture of water and glycerol 1:1 in volume. In this way, after mixing

3. T-CYCLE EPR FOR THE INVESTIGATION OF CHEMICAL DYNAMICS

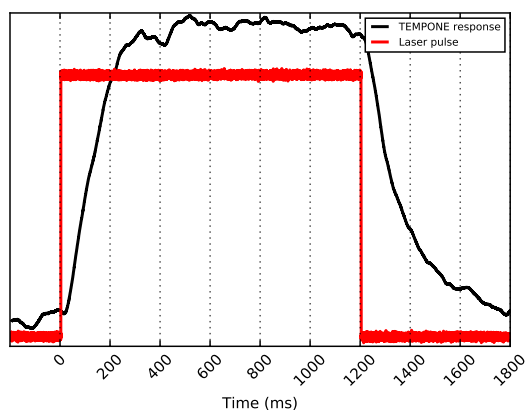

Figure 3.3: Black: time profile of the EPR signal of a solution of TEMPONE (at a concentration of 2 mM, in a mixture of water and glycerol 1:1 in volume), when heated with a 1200 ms long laser pulse at 3.5 W, from a cryostat-regulated temperature of 243 K. The red trace represents the laser pulse, turned on at $t = 0$. The time profile is visualized with an oscilloscope while measuring the 275 GHz EPR intensity of the TEMPONE solution at a magnetic field of 9.8202 T, which is a field position where the spectral intensity of TEMPONE is particularly sensitive to temperature variations (as can be appreciated in Figure 3.13).

equal volumes of the two reagents, the resulting concentrations of TEMPOL and ascorbic acid were 2 and 1 mM, respectively. Unless otherwise specified, all the experiments described in this Chapter were performed on samples having the above mentioned composition.

Since under such conditions the reduction of TEMPOL by ascorbic acid takes place on a time scale of minutes, the manual mix of the components is an easy procedure. To prepare each sample, 100 μL of TEMPOL were added to 100 μL of ascorbic acid under magnetic stirring, and after waiting a few seconds to let the two solutions mix homogeneously, a previously prepared quartz capillary (150 μm inner diameter) is dipped in the mixture, which is collected simply by capillary force. The capillary is then rapidly dropped in liquid nitrogen so as to stop the reaction, and stored for later measurements. The whole procedure, from the manual mixing to the freezing of the filled capillary, takes between 7 and 10 seconds, which constitute an acceptable "dead time" of the method, considering the time scales involved in the experiments described in this Chapter.

3.3.2 Setup

The samples are introduced in the single-mode cavity of a pre-cooled home-built probe head [43] in the way described in Chapter 2 of this thesis. The probe head is then inserted in the He-flow cryostat (CF935, Oxford Instruments) of a home-built 275 GHz EPR spectrometer [34], at a Measurement Temperature of 223 K. A Preparation Temperature of 243 or 263 K, depending on the experiment, is reached prior to the application of a T-jump.

The probe head is wired with a multi-mode optical fiber (Thorlabs, model n. FG105LCA, 0.22 NA, core size 105 μm , FC/PC connector to the laser) that couples the cavity to a diode laser operating at 1550 nm, with a maximum output power of about 3.5 W (SemiNex Corp., model n. HHF-110, serial n. 2027). The diode laser is mounted on a home-built power supply and fan-cooling unit that allows the tuning of the input current fed to the laser and thus of the output power.

As schematically shown in Figure 3.4, the flat-cleaved end of the fiber enters the bottom of the probe head, facing the grid-like part of the brass cavity and thus allowing direct irradiation of the sample.

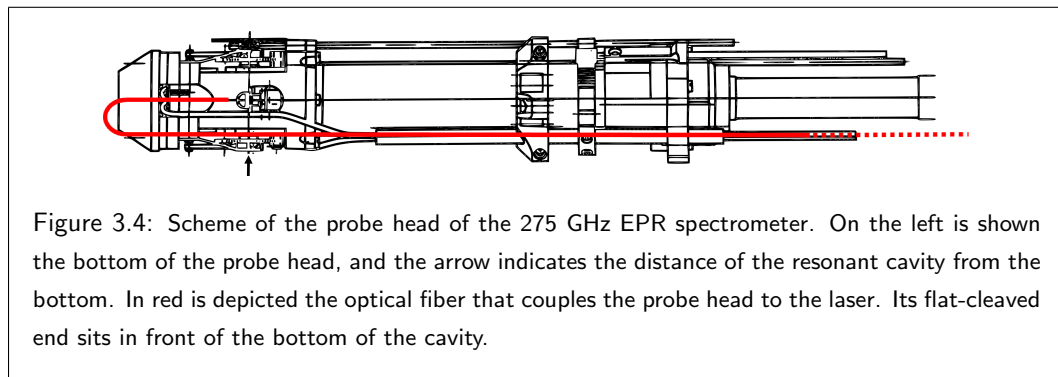

Figure 3.5 depicts a zoomed-in scheme of the flat-cleaved end of the optical fiber wired to the probe head. The optical fiber with its protective tubing (shown in orange) is secured on a T-shaped brass support, which is later screwed onto the bottom of the probe head. The terminal portion of the fiber's protective tubing is removed, and the fiber is fastened on the brass support. The last portion of the fiber's cladding is stripped off, and the bare fiber is exposed. Appropriate lengths are illustrated in the Figure.

Given the time scale of minutes at which the system under study reacts, relatively long laser

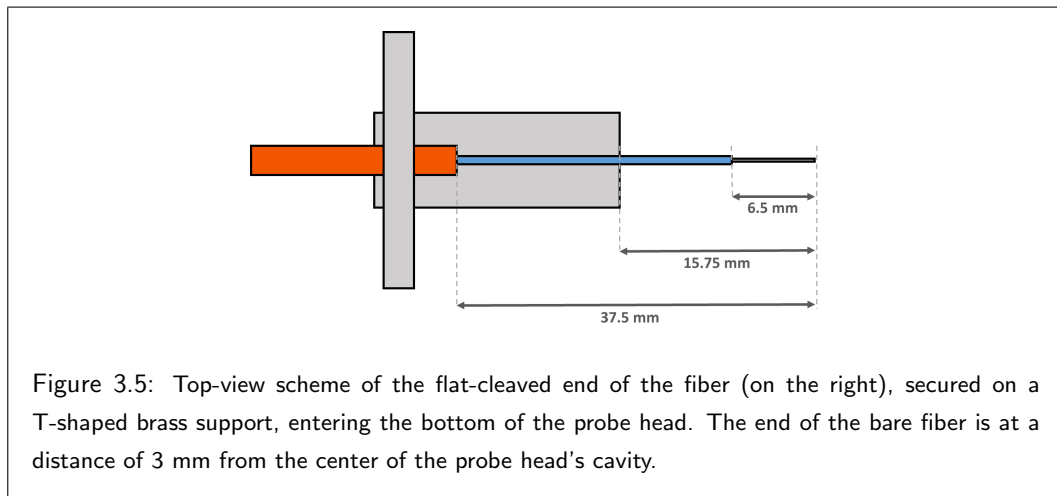

Figure 3.5: Top-view scheme of the flat-cleaved end of the fiber (on the right), secured on a T-shaped brass support, entering the bottom of the probe head. The end of the bare fiber is at a distance of 3 mm from the center of the probe head's cavity.

pulses – of the duration between 20 and 400 s – were applied in the experiments described in Section 3.4.

The cryostat temperature was detected with a Pt100 sensor, whose resistance and calculated temperature values were read with a Keithley 2100 6¹/₂ Digit Multimeter (Tektronix). The Pt100 sensor is located in the close proximity of the insert's cavity; however, since it is not situated exactly *in* the cavity, the actual temperature of the sample might deviate from those presented here.

3.3.3 Internal standard

Preliminary experiments showed that uncontrolled changes in the EPR cavity occur upon laser irradiation, resulting in variations of the TEMPOL signal that may be larger than its decay due to the reduction of TEMPOL by ascorbic acid. Such variations might thus make it impossible to follow a kinetic curve without the use of a standard signal.

A broadly used standard in EPR is the manganese(II) ion, which at high frequency shows six intense and well-defined lines arising from the transition between the two spin states $m_s = \pm 1/2$, further split by the nuclear hyperfine interaction with the nuclear spin $I = 5/2$ of the manganese nucleus.

At the time of the experiments described in this Chapter, an incidental presence of Mn^{2+} signals was observed in the cavity of the 275 GHz spectrometer. Since this contamination clearly showed the typical 6-line spectrum of Mn^{2+} (see Figure 3.6), with spectral intensities suitable for the

purposes of the present research, it was used in the experiments described below (Section 3.4), instead of adding MnCl_2 to the solution. This procedure differs from what is commonly done in EPR studies, where manganese(II) is added in small concentration to the studied system in the form of MnCl_2 [66].

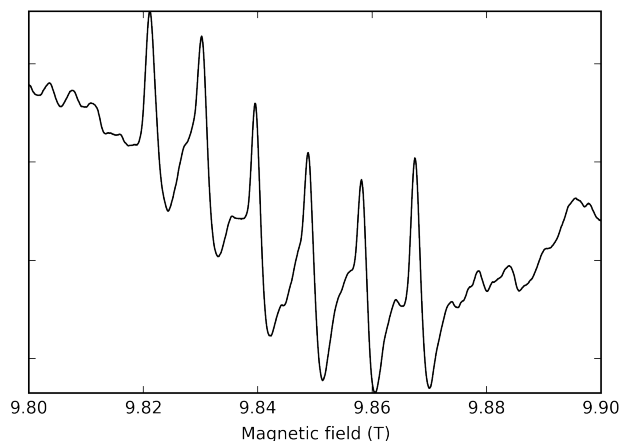

Figure 3.6: Room-temperature cw EPR spectrum at 275 GHz of the Mn^{2+} present in the probe head cavity as an incidental contamination, and used as an internal standard.

3.4 Temperature-Cycle EPR demonstrated on a model reaction

This Section describes the application T-Cycle EPR on frozen mixtures of TEMPOL and ascorbic acid, whose reaction is taken as a model system for the present investigations (as described in Subsection 3.4.1). Subsection 3.4.2 shows that T-Cycle EPR yields kinetics on a time scale of minutes. Subsection 3.4.3 shows that T-Cycle EPR allows to study chemical reactions flexibly, as arbitrary Reaction Temperatures can be reached by selecting appropriate Preparation Temperatures and laser powers.

3.4.1 The TEMPOL-ascorbic acid reaction as a model system

In order to show the working of T-Cycle EPR, a well-known model reaction was used, namely the reduction of the nitroxyl radical TEMPOL (4-hydroxy-TEMPO) by ascorbic acid, yielding

3. T-CYCLE EPR FOR THE INVESTIGATION OF CHEMICAL DYNAMICS

the corresponding diamagnetic hydroxylamine (a scheme of the reaction is shown in Figure 3.7) [67] [68] [69] [70]. This reaction is particularly advantageous for the purposes of this Chapter for two reasons. Firstly, it occurs on relatively long time scales (minutes), which is ideally suited for the demonstrative experiments aimed at proving the effectiveness of T-Cycle EPR. Secondly, the fact that the TEMPOL molecule gives rise to spectra that differ greatly in intensity and shape as a function of temperature (as described in Section 3.2), is of great use for the determination of the reaction temperatures reached upon application of the T-jumps, as described in detail in the Appendix to this Chapter.

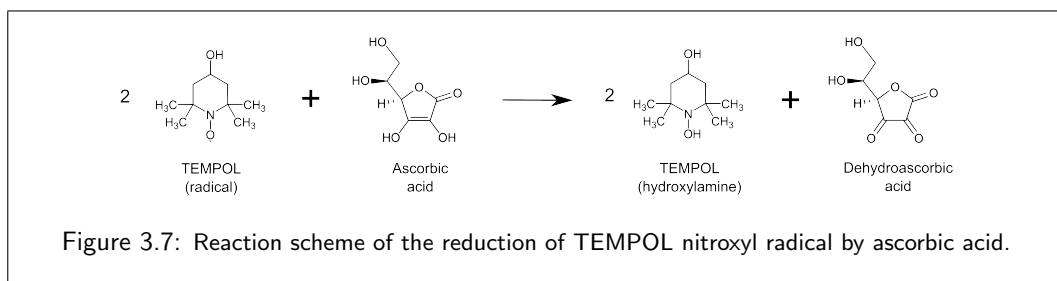

Figure 3.7: Reaction scheme of the reduction of TEMPOL nitroxyl radical by ascorbic acid.

Before going into the details of the results, a brief introduction will be given as to what a typical EPR spectrum of a nitroxide radical looks like at high microwave frequency.

As can be seen from the representation of the TEMPOL molecule in the left-hand side of Figure 3.7, a single unpaired electron, having spin $S = 1/2$, is localized on the nitroxide group of the molecule and thus interacts with the ^{14}N nucleus, which possesses nuclear spin $I = 1$. This hyperfine interaction causes a splitting of the spin energy levels of the electron, which in addition exhibits an anisotropic \mathbf{g} tensor. The resulting high-frequency EPR spectrum is shown in Figure 3.8, arising from a frozen TEMPOL solution. The three components g_x , g_y , and g_z of the \mathbf{g} tensor are clearly separated. The splitting of the lines into $2I + 1 = 3$ components due to the hyperfine interaction with the ^{14}N nucleus is only visible in the high-field part of the spectrum, as the hyperfine tensor \mathbf{A} is anisotropic too and only the A_z component is large enough to be resolved [24].

Finally, three out of six lines of the Mn^{2+} spectrum are visible around 9.86 T (the first three, at lower field, are hidden in the TEMPOL spectrum, which is much more intense).

In order to monitor the reduction of TEMPOL by ascorbic acid, for each time point the intensity of the g_x component of the EPR spectrum of TEMPOL at 9.8064 T was measured, and divided by the peak-to-peak intensity of the fifth line of the spectrum of Mn^{2+} at 9.858 T,

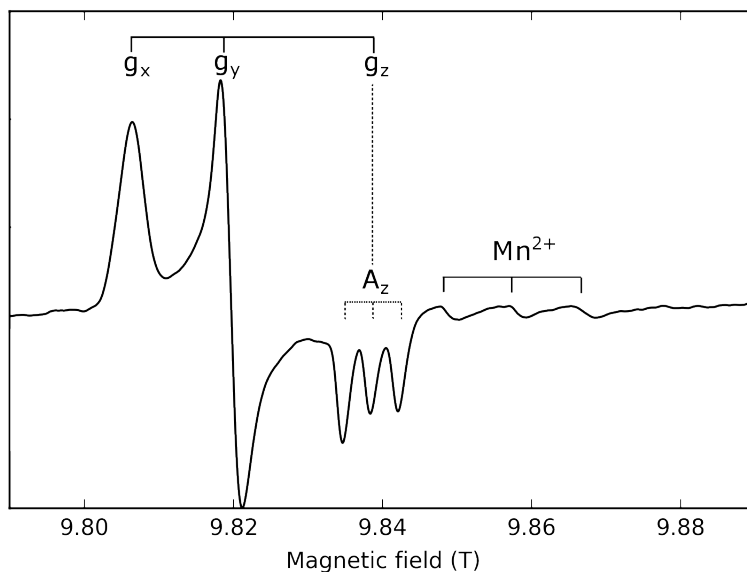

Figure 3.8: Continuous-wave 275 GHz EPR spectrum at 223 K of a frozen solution of TEMPOL at a concentration of 2 mM, in a mixture of water and glycerol 1:1 in volume. The three high-field components are part of the six-line spectrum of Mn^{2+} , present as an incidental impurity in the spectrometer's cavity.

used as a standard as described in Subsection 3.3.3. A decay curve is thus obtained by plotting the Mn-normalized decrease of the spectral intensity of TEMPOL as a function of the time steps where the laser was turned on. The g_x peak of TEMPOL at 9.8064 T was chosen because it does not overlap with the Mn^{2+} spectrum, and because it is known that the ascorbate radical anion gives a signal overlapping the g_y of TEMPOL [67].

Similarly to the procedure described in Chapter 2 of this thesis, in order to obtain a decay from the reduction of TEMPOL by ascorbic acid, the quantity $Y(t)$ has to be calculated from the decay of the TEMPOL signal as a function of time. $Y(t)$ is the ratio of the concentration of TEMPOL at any time point t and at $t = 0$, $[T^L]_t/[T^L]_0$, and is directly proportional to the ratio of the EPR intensity of the respective signals normalized by the Mn^{2+} signal, $(S'_{TL})_t/(S'_{TL})_0$, as shown in Equation 3.1. Note that S' represents the signal S normalized by manganese (Equation 3.2). Note that although S_{Mn} does not change as a function of time, it still might differ from spectrum to spectrum due to the changes in the cavity induced by the laser-induced T-jumps.

3. T-CYCLE EPR FOR THE INVESTIGATION OF CHEMICAL DYNAMICS

It is therefore measured for each spectrum.

$$Y(t) = \frac{[TL]_t}{[TL]_0} = \frac{(S'_{TL})_t}{(S'_{TL})_0} \quad (3.1)$$

$$(S'_{TL})_t = \frac{(S_{TL})_t}{S_{Mn}} \quad (3.2)$$

The EPR spectra used to determine the decays described in Section 3.4.2 and 3.4.3 are the average of four scans. Whenever shown, the error bars associated to the points of the decays represent the standard errors calculated from the four scans. Table 3.1 displays the experimental parameters used to record the spectra.

Field range (T)	# of points	Mod. freq. (kHz)	Mod. ampl. (mT)	Time const. (s)	Conversion time (ms)	Microwave power (μ W)	T (K)
9.7950 \div 9.8650	1800	1.253	1.0	1	62.5	1.74	223

Table 3.1: Experimental parameters of the spectra at 275 GHz. *Mod. freq.* and *Mod. ampl.* are the field modulation frequency and amplitude, respectively.

3.4.2 First demonstration of Temperature-Cycle EPR

The application of T-Cycle is demonstrated on a frozen mixture of TEMPOL and ascorbic acid, and the resulting kinetics is observed at 275 GHz. The T-Cycle steps designed for this experiment, of the kind shown in Figure 3.2, feature a Measurement Temperature of 223 K, and a Preparation Temperature of 243 K, both cryostat-controlled. The T-jumps are applied with laser pulses at a nominal power of 3.5 W, with a duration of either 50 or 100 s. The experiment described in this Subsection is henceforth referred to as "Experiment A".

Figure 3.9 A shows the 275 GHz EPR spectra of TEMPOL normalized by Mn^{2+} , each obtained after a T-Cycle step described above. The low-field part of the spectrum shows the g_x component of TEMPOL, which is the only one not overlapping with the Mn^{2+} spectrum used for normalization. Figure 3.9 B is a zoomed-in view of the g_x component of TEMPOL, which shows a decay as a function of the laser time (red to blue).

By plotting the quantity $Y(t)$ (introduced in Subsection 3.4.1) as a function of the "laser time", a clear decay curve is achieved, as shown in Figure 3.10. The laser-time axis is obtained by summing up the duration of each T-jump in the T-Cycle sequence, up to 450 s. A decay with a characteristic time of more than 100 s can be observed.

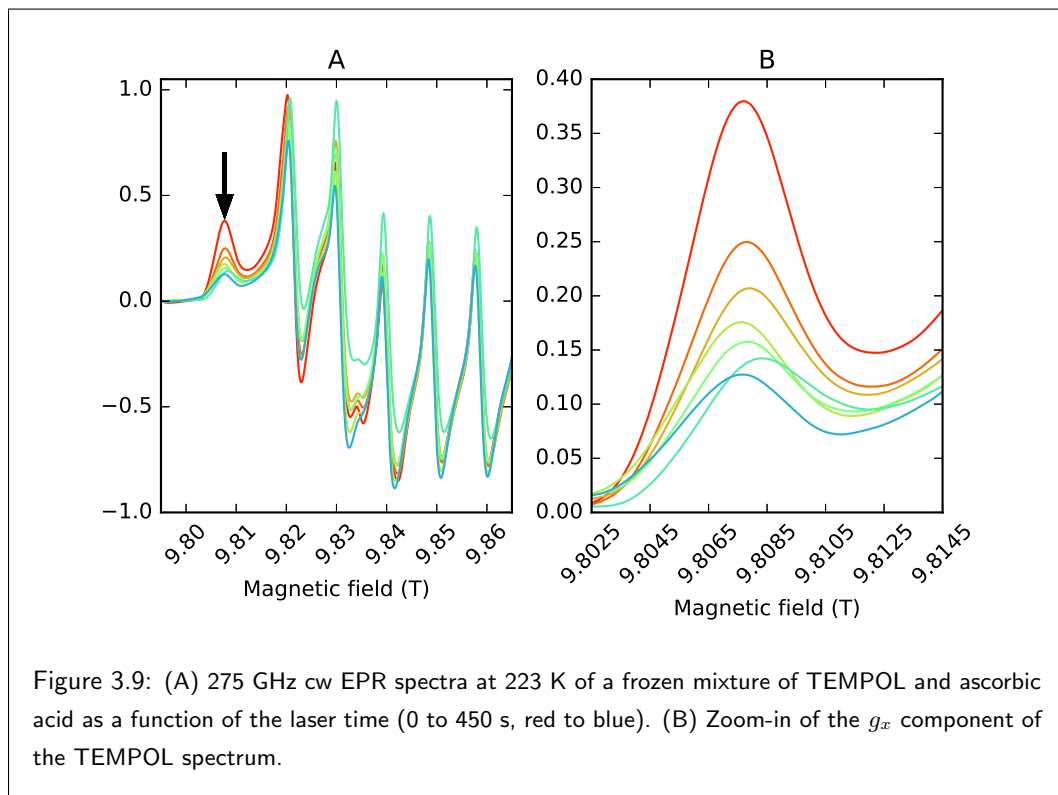

3.4.3 Flexibility of Temperature-Cycle EPR

Being able to achieve different Reaction Temperatures, either by adjusting the Preparation Temperature, or by applying laser pulses of different power, is a desirable feature of the T-Cycle method, as it provides flexibility in the study of chemical kinetics in conditions different from room temperature. This Subsection describes the feasibility of different kinds of T-Cycle EPR experiments on samples of identical composition.

Figure 3.11 shows the design of three experiments performed to show the flexibility of the T-Cycle method. In the rest of this Subsection, the three temperatures that constitute the T-jumps (as described in Section 3.2) will be shortened as T_{meas} , T_{prep} , and T_r .

The three experiments A, B, and C, carried out at a T_{meas} of 223 K on three frozen mixtures of TEMPOL and ascorbic acid of identical composition, are described below. Note that Experiment A is the same as that described in Subsection 3.4.2.

(A) From $T_{prepA} = 243$ K, a laser power of 3.5 W is applied, letting the sample reach a T_{rA}

3. T-CYCLE EPR FOR THE INVESTIGATION OF CHEMICAL DYNAMICS

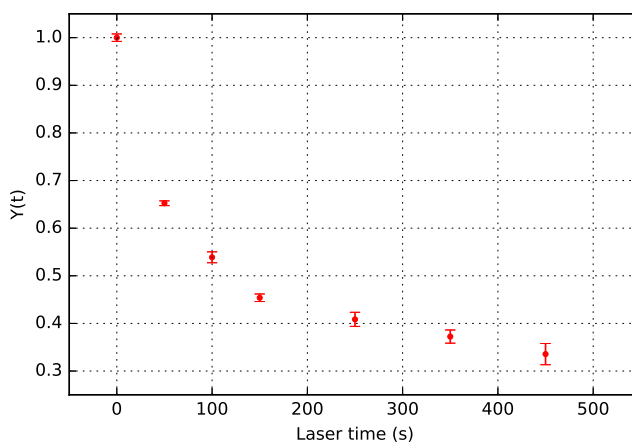

Figure 3.10: Decay curve of a frozen mixture of TEMPOL and ascorbic acid.

of about 360 K.

- (B) From $T_{prepB} = 243$ K (the same as T_{prepA}), a laser power of 2.8 W is applied, letting the sample reach a T_{rB} of about 330 K. Given the lower T_r , a slower reaction is expected as compared to Experiment A.
- (C) From $T_{prepC} = 263$ K, a laser power of 3.5 W is applied, letting the sample reach a T_{rC} of about 380 K. Given the higher Reaction Temperature, a faster reaction is expected as compared to Experiment A.

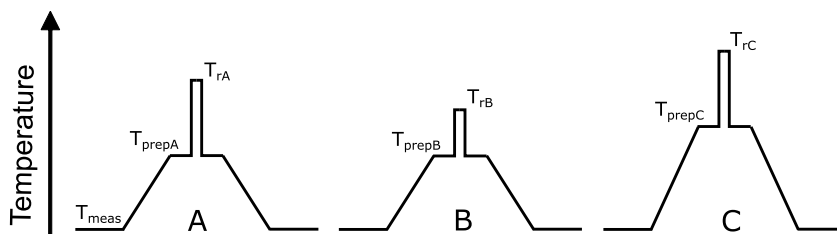

Figure 3.11: Scheme representing the steps of the flexibility experiment.

The Reaction Temperatures reported above are determined from the temperature calibration

described in the Appendix to this Chapter.

For Experiment B and C, decay curves were obtained similar to that of Experiment A, already shown in Figure 3.10, but with different decay times, as expected. As shown in Figure 3.12, experiments A, B, and C yield three distinct decays for frozen mixtures of TEMPOL and ascorbic acid with the same composition, confirming that kinetics at different Reaction Temperatures can be obtained with T-Cycle EPR by flexibly altering the Preparation Temperature and/or the laser power. Furthermore, it can be appreciated that the decay rates shown in Figure 3.12 are consistent with the experiment scheme of Figure 3.11: to a higher Reaction Temperature corresponds a faster kinetic decay, namely A and C faster than B, with T_{rA} and T_{rC} higher than T_{rB} .

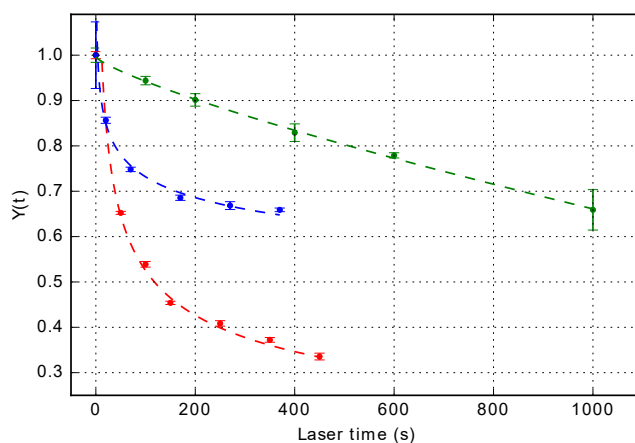

Figure 3.12: Decay curves obtained from Experiment A (red), B (green), and C (blue). The dotted lines are meant to guide the eye.

3.5 Discussion and conclusions

For the first time, the *in-situ* application of laser-induced T-jumps is coupled to high-frequency EPR (275 GHz) for the investigation of chemical kinetics. By taking as a model reaction the reduction of TEMPOL nitroxide by ascorbic acid, Temperature-Cycle EPR is shown to be an effective, versatile, and flexible method.

The first proof of T-Cycle EPR was applied on a time scale of minutes, yielding a characteristic

3. T-CYCLE EPR FOR THE INVESTIGATION OF CHEMICAL DYNAMICS

time of about 100 s. This result is corroborated by literature data, where decays of the TEMPOL-ascorbate system on the same time scale are reported [67] [69] [71] [72]. In these studies, the concentration conditions were such that the reaction exhibits a pseudo-first-order behavior; moreover, since the species actually responsible for the TEMPOL reduction is the ascorbate anion, the system was buffered so as to maintain a pH that maximizes the concentration of ascorbate rather than ascorbic acid. In the present work, neither pseudo-first-order conditions were employed, nor buffered solutions. Our aim was not that of achieving quantitative kinetic results, but rather that of showing the validity of the T-Cycle EPR method.

T-Cycle EPR allows a flexible temperature manipulation of the sample, whereby faster or slower kinetic behaviors can be obtained depending on the higher or lower Reaction Temperature reached. By selecting an appropriate Preparation Temperature (through the cryostat's temperature controller) and an appropriate laser power for the T-jump, the frozen sample reaches different Reaction Temperatures, and resultingly different decays are obtained. Depending on the composition of the solvent, T-jumps between 20 and 120 °C can be achieved, as described in the Appendix to this Chapter. This wide range of T-jumps makes it possible to study chemical kinetics unfolding at conditions different than room temperature, offering an advantageously flexible applicability of the T-Cycle method.

From the decays depicted in Figure 3.12, three different kinetics are obtained from experiments A, B, and C. These three experiments differ in the Reaction Temperature the sample reaches, namely T_{rA} and T_{rC} are higher than T_{rB} . The reduction of TEMPOL by ascorbic acid is an endothermic reaction [73], thus a slower decay is expected upon decreasing the Reaction Temperature. Consistently, the fastest decay is measured for experiments A and C, followed by experiment B.

In conclusion, this Chapter described the development of Temperature-Cycle EPR, a novel, versatile technique to study chemical kinetics and paramagnetic intermediates of (bio)molecular systems. Firstly, it was shown that T-Cycle EPR works in observing decays on time scales of minutes. Secondly, a series of experiments were designed to show that, by manipulating the Preparation Temperature and/or the laser power associated to the T-Cycle steps, different Reaction Temperatures are achievable, which makes T-Cycle a flexible and powerful technique for the investigation of (bio)molecular dynamics.

Important advantages of T-Cycle EPR are the use of only one sample to carry out a kinetic study, which does not pose limitations on the reproducibility of the sample preparation, and the need for only a small amount of material. Both characteristics are important features of T-Cycle

EPR, and are beneficial with respect to other methods that require larger amounts of materials and/or multiple samples, such as Rapid Freeze-Quench or flow methods.

The time scales described in this Chapter (of hundreds of seconds) were convenient as a first proof of the feasibility of the method, but are of limited applicability when investigating molecular processes that are not *ad-hoc* slowed down, such as most chemical kinetics and biochemical processes. However, since the T-Cycle method is based on laser pulses, it is in principle possible to downsize the time scales by several orders of magnitude, so as to achieve sub-second time scales that should give access to many biochemical processes.

3.6 Appendix

Azarkh and Groenen [24] characterized what temperature is possible to reach upon irradiating the cavity with an infrared diode laser operating at 1550 nm. Depending on the solvent composition, they reported T-jumps of over 50 °C with an appropriate laser power.

Characterizing the temperature reached by the sample is possible thanks to the fact that solutions of nitroxide radicals show significant spectral changes as a function of temperature. Such changes are related to the rotational correlation time, τ_c , of the molecule in its medium. An expression of τ_c is given by Equation 3.3, which is the rotational-diffusion equivalent of the Stokes-Einstein equation, commonly used in EPR studies [28]:

$$\tau_c = \frac{4\pi\eta r_0^3}{3k_B T} \quad (3.3)$$

with η and T being, respectively, the viscosity and the absolute temperature of the solution, r_0 the hydrodynamic radius of the diffusing molecule, and k_B the Boltzmann constant.

Since τ_c is a function of the viscosity and of the temperature of the solution, the high-frequency EPR intensity and shape variations of nitroxide radicals represent a good indicator of the temperature changes of solutions whose viscosity varies strongly with temperature. In particular, mixtures of water and glycerol exhibit a strong dependence of their viscosity on temperature [74], and are thus particularly suited to be used as solvents of nitroxide radicals for a temperature calibration of a T-Cycle experiment. Following is a characterization of the temperatures reached upon application of T-jumps on a solution of TEMPOL in a mixture of water and glycerol, with the setup described in Subsection 3.3.2. Such temperature calibrations are closely dependent on the setup used and, needless to say, on the composition of the sample and on the sample holder. The main factors to be taken into account are, among others, the model and connector of the diode laser and the optical fiber, the distance of the bare fiber's end from the cavity, and

3. T-CYCLE EPR FOR THE INVESTIGATION OF CHEMICAL DYNAMICS

the laser's power supply and cooling system. These elements all affect the effective amount of laser power that is absorbed by the sample, and therefore the final temperature reached during a T-jump.

Figure 3.13 shows the dependence on temperature (A) and on laser power (B) of the 275 GHz cw EPR spectrum of a TEMPOL solution (2 mM) in a mixture of water and glycerol 1:1 in volume. Interpretation of the 275 GHz EPR spectrum of TEMPOL is provided in Subsection 3.4.1; what is interesting to realize is the huge variation of the spectral shape as a function of temperature, here shown in the range between about -32 and +23 °C (Figure 3.13 A).

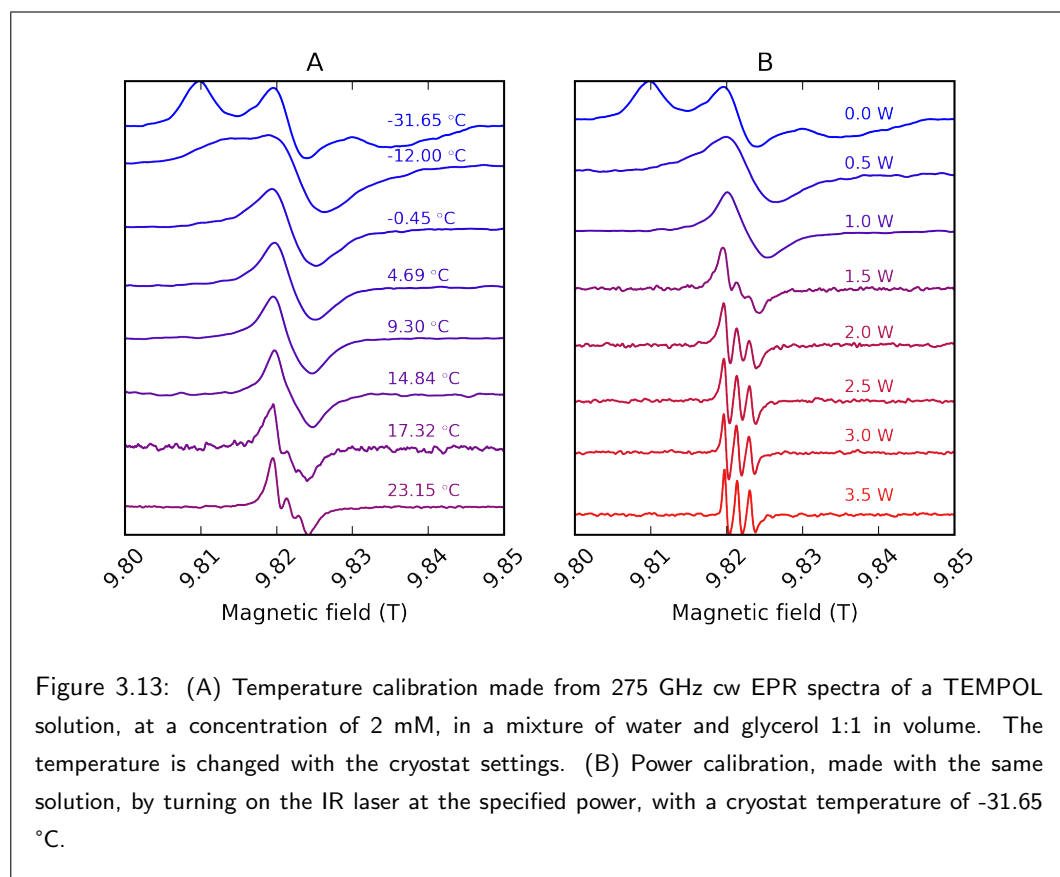

Figure 3.13: (A) Temperature calibration made from 275 GHz cw EPR spectra of a TEMPOL solution, at a concentration of 2 mM, in a mixture of water and glycerol 1:1 in volume. The temperature is changed with the cryostat settings. (B) Power calibration, made with the same solution, by turning on the IR laser at the specified power, with a cryostat temperature of -31.65 °C.

A temperature calibration is possible by considering that to each temperature corresponds a unique value of the ratio of viscosity and temperature, η/T , of a solution of given composition. This is shown in Figure 3.14 (red triangles), where tabulated values of η/T are plotted as a

function of temperature, for a mixture of water and glycerol 60% in weight [74].

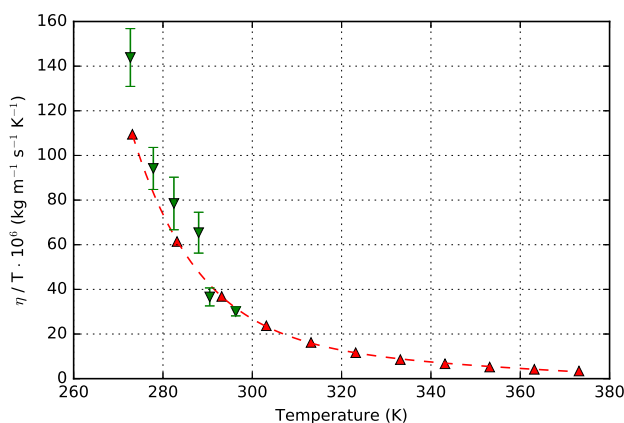

Figure 3.14: Values of η/T plotted versus T . Red triangles: obtained from [74] for a mixture of water and glycerol 60% in weight. Green triangles: obtained with Equation 3.3 from the EasySpin simulations of the spectra of Figure 3.13 A. The error bars are calculated from the error estimation on the τ_c calculated from the simulations.

Since there is a unique relation between η/T and T , the same must be true for η/T and τ_c , as expressed by Equation 3.3. By simulating the spectrum at 23.15 °C of Figure 3.13 A with EasySpin (v. 5.2.16, run on MATLAB Release 2017a) [31], a rotational correlation time $\tau_c = 100$ ps is found (in agreement with [24]). This value, together with a viscosity of 7.75 centipoise obtained from [74], are used to find the hydrodynamic radius to be $r_0 = 2.3$ Å with Equation 3.3, which is in agreement with the value ranges reported in the literature [75].

With a determined value of r_0 , it is possible to obtain ratios of η/T from the EasySpin simulations of the spectra of Figure 3.13 A, and associate them to the corresponding temperatures. This is shown in Figure 3.14, where the green triangles (calculated from simulations) match quite well the red dots (tabulated). Note that the calculated points refer to a mixture of water and glycerol 50% in *volume*, which corresponds to $\sim 56\%$ in *weight*, very close to the 60% weight composition of the tabulated data. In Figure 3.15 are shown the simulations run on the spectra of Figure 3.13 A.

Running EasySpin simulations on the spectra of Figure 3.13 B (as a function of nominal laser power) yields values of τ_c and, through Equation 3.3, ratios of η/T associated to each laser

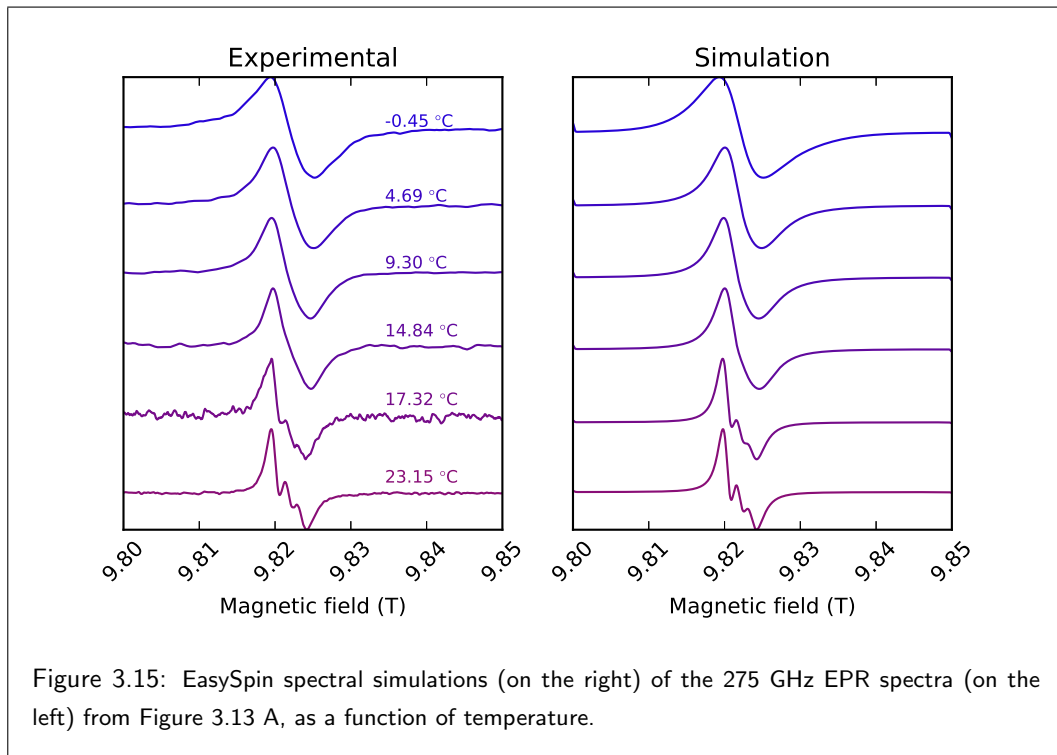

Figure 3.15: EasySpin spectral simulations (on the right) of the 275 GHz EPR spectra (on the left) from Figure 3.13 A, as a function of temperature.

power. In Figure 3.16 are shown the simulations run on the spectra of Figure 3.13 B. By making use of the fitting (red dotted line) of the tabulated points of Figure 3.14, it is possible to turn the ratios η/T to values of temperatures, and associate them to the respective nominal laser powers. Calculation of the relative T-jumps is then straightforward, and their relation to the laser power is shown in Figure 3.17, where a linear trend is observed within the evaluated errors (which is consistent with what reported in [24] for T-jumps between 10 and 55 °C). T-jumps between roughly 20 to 120 °C can be obtained in the nominal power range between 0.5 to 3.5 W. It should be noticed that these values of T-jumps derive from the extrapolation of the experimental points of Figure 3.14 (green triangles) to higher temperatures, assuming they match the reference data points (red triangles of Figure 3.14).

It can be appreciated how faithfully the simulations of Figures 3.15 and 3.16 reproduce the experimental spectra, confirming that the model chosen here is appropriate. Table 3.2 summarizes the parameters fed to EasySpin for the simulations: while the main parameter that was varied to fit the simulations to the spectra was the τ_c , also the microwave frequency had to be slightly adjusted for each simulation – the latter in order to account for the magnetic field

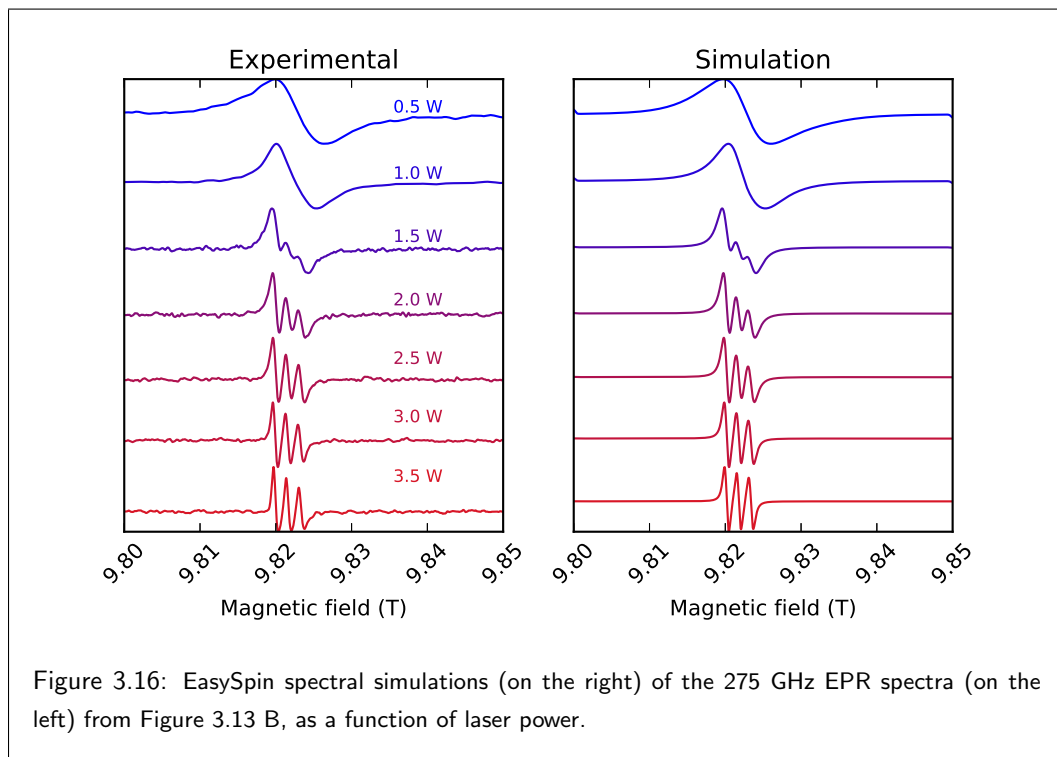

Figure 3.16: EasySpin spectral simulations (on the right) of the 275 GHz EPR spectra (on the left) from Figure 3.13 B, as a function of laser power.

shifts associated to each experimental scan. The peak-to-peak intrinsic linewidth mentioned in Table 3.2 is a parameter EasySpin requires in order to produce a smooth spectral output.

As a final remark, from Figure 3.13 it can be appreciated how the spectral linewidth decreases with increasing temperature or, equivalently, with increasing laser power. By defining what is here referred to as "partial linewidth", i.e., the full width at half maximum of the peak around 9.8195 T for the spectra of Figure 3.13 B, it is possible to obtain a measure of the line broadening of each spectrum. Notice that the partial linewidth can be unequivocally quantified only for the spectra that are not in the rigid-limit regime, namely – for the spectra shown here – from $-0.45\text{ }^{\circ}\text{C}$ onwards.

Since the partial linewidths are unambiguously associated to their corresponding laser powers, it is possible to link the T-jumps from Figure 3.17 – and therefore the temperature of the sample, taking into account the Preparation Temperature – directly to the partial linewidths, as shown in Figure 3.18. Partial linewidths can thus be translated to temperatures in a one-to-one relation, which allows the determination of the latter in a convenient manner, since measuring the spectra's partial linewidths is a much easier and more straightforward procedure than obtaining rotational

3. T-CYCLE EPR FOR THE INVESTIGATION OF CHEMICAL DYNAMICS

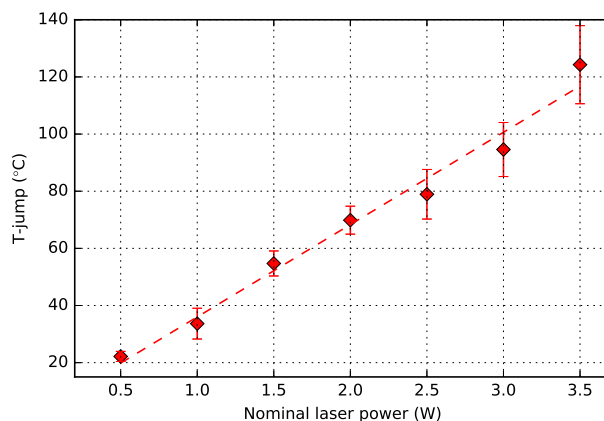

Figure 3.17: T-jumps as a function of the nominal laser power. The T-jumps are calculated from the fitting of the values of T versus η/T (see Figure 3.14), from the starting temperature of -31.65 °C. The error bars are calculated from the error estimation on the τ_c calculated from the simulations.

correlation times through simulations, or using the second-moment analysis described in [24].

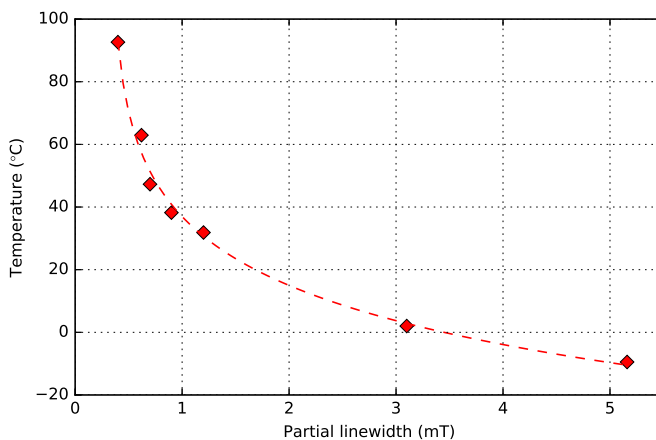

Figure 3.18: Relation between the sample temperature and the partial linewidth of the corresponding 275 GHz cw EPR spectrum. The dotted line is a guide to the eye.

3. T-CYCLE EPR FOR THE INVESTIGATION OF CHEMICAL DYNAMICS

Simulated spectrum	τ_c (ps)	μW freq. (GHz)
-0.45 °C	550 ± 50	275.75
4.69 °C	360 ± 36	275.75
9.30 °C	300 ± 45	275.74
14.84 °C	250 ± 35	275.74
17.32 °C	140 ± 15	275.725
23.15 °C	115 ± 7	275.725
0.5 W	600 ± 48	275.77
1.0 W	340 ± 54	275.76
1.5 W	130 ± 10	275.72
2.0 W	70 ± 5	275.72
2.5 W	50 ± 5	275.72
3.0 W	30 ± 3	275.72
3.5 W	15 ± 2	275.72

Table 3.2: EasySpin parameters of the simulations of the 275 GHz EPR spectra from Figures 3.15 and 3.16. The two parameters that are varied to adjust the simulation to the experimental spectrum are the rotational correlation time (τ_c) and the microwave frequency (μW freq.). The other parameters, kept fixed, are: field range, 9.8 ÷ 9.850 T; number of points, 1000; peak-to-peak intrinsic linewidth, 0.3 mT (taken 50% Gaussian and 50% Lorentzian); **g** tensor, [2.0083 2.0058 2.0030]; **A** tensor for ^{14}N , [18 18 99] (in MHz). The last two are taken from [24]. Notice that the microwave frequency is adjusted to compensate for the shifts in magnetic field, the largest totaling 1.8 mT.

