



Universiteit
Leiden
The Netherlands

The certainty of change : a research into the interactions of the decoration on the western walls of the cult chapels of the mastabas at Giza during the Old Kingdom

Roeten, L.H.

Citation

Roeten, L. H. (2011, March 23). *The certainty of change : a research into the interactions of the decoration on the western walls of the cult chapels of the mastabas at Giza during the Old Kingdom*. Retrieved from <https://hdl.handle.net/1887/16646>

Version: Not Applicable (or Unknown)

License: [Licence agreement concerning inclusion of doctoral thesis in the Institutional Repository of the University of Leiden](#)

Downloaded from: <https://hdl.handle.net/1887/16646>

Note: To cite this publication please use the final published version (if applicable).

Chapter VII

The relation between the (sub)themes on the western wall.

The terms “funerary”, “cultic” and “ritual” are discussed and working definitions are proposed for them. In order to describe the cultic character of the (sub)themes placed on the western wall, diverse types of cultic character are defined, including the type “non-cultic”. The determination of the cultic character of a (sub)theme is based on its interaction with the main (sub)themes 2 and 3 of which the cultic character has been defined previously. The cultic character of all of the (sub)themes placed on the western wall is thus determined, together with its chronological development. A final discussion of the unifying function of (sub)themes 5, 7 and 10 is given.

I. Preliminary considerations.¹

The cult chapel of a tomb is the place where offerings are deposited, an action that is repetitive, as is clearly stated in the offering formula, thus making it a ritual. Apart from the false door, which is the focus of the cult for the *ka* of the deceased, the decoration of the western wall, or at least part of it, undoubtedly had a role in the cult too. Quite possibly, some of the (sub)themes placed on the western wall had different cultic roles.

Scenes depicting a burial and/or the rites connected to it are extremely rare in the cult chapel itself, and are never placed on its western wall (see also chapter I). The only tombs in which funerary activities are depicted on the walls of the chapel are the ones of ‘Ankhma’re’ (PM, III¹, 206), where they are placed on the northern wall, and Debhen (PM, III¹, 235-6; infra figure I.18), where they are placed on the southern wall.

Because scenes depicting funerary activities are not intended for the daily sustenance of the deceased, they are not being put on the western wall; as a consequence they are not significant for this research project.

Van Walsem concludes that artefacts which are frequently found in a funerary context are not automatically attributed with a funerary charge.² The same can be concluded for artefacts frequently found in a clearly cultic surrounding.

As a working hypothesis a possible division of the cultic character of (sub)themes is proposed in figure VII.1. This division is based on the purpose of the (sub)theme on the western wall.

This division is only partly identical to the one proposed by Van Walsem.³ His division of the (sub)themes is as follows:

1. Scenes from the daily life of the tomb owner.
2. Immaterial existence (divided into a. ideological and b. symbolic, religious).

Aldred proposes the following two types of (sub)themes in the chapel:⁴

1. Scenes from daily life; an ideal everyday life spent on earth (type Ia cultic character) and desired in the hereafter.⁵ This statement that knows a nearly general acceptance in the professional world has been called in question by Weeks.⁶

¹ The character of the (sub)themes on the walls of the cult chapel is multiple:

As proposed in the above working hypothesis, there is a distinction between the types I (cultic) (sub)themes and II (non-cultic) (sub)themes (figure VII.1). In figure VII.3 type I is divided into types Ia and Ib, and type II in types IIa and IIb. The (sub)themes directly connected with the cult for the *ka* of the deceased are of type I, and the (sub)themes which are not indispensable for the cult itself, but which play a role in the total functioning of the cult chapel, are of type II.

² Van Walsem, *Sense*, 299.

³ Van Walsem, *Interpretation*, 1208-9.

⁴ Aldred, *Art*, 88 ff.

2. The cult for the deceased (type Ib cultic character). The latter was necessary in order to sustain the *ka* of the deceased and thus assure its continued life in the hereafter.

The proposition as given by Aldred appears to be contradicted by the results of this research project, in which the existence of (sub)themes with a unifying function is introduced.

The proposed working hypothesis is based on the following considerations:

1. The basic argument is that if two (sub)themes avoid each other on the western wall of the chapel, they have a different cultic character; if they have an association, their cultic character is identical.

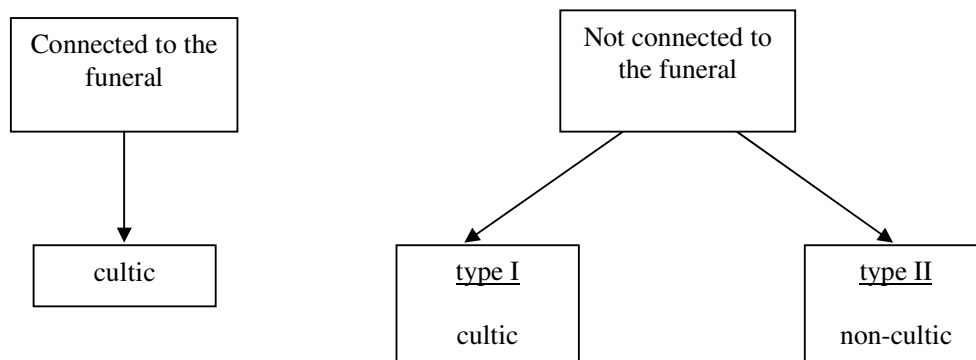

Figure VII.1: Preliminary definition of the character of (sub)themes.

2. Already in chapter V (section III, point 4) a distinction has been made between the cultic character of (sub)themes 2 (the tomb owner in physical contact with family) and 3 (the tomb owner at the offering table).⁷ One of the basic arguments for this is the strong dissociation between the two (sub)themes (table VI.2.Vol.2, CP/SWS = 26/0 (7), a value which places the interaction deep in the dissociation area of figure VI.16. The FO values of (sub)themes 2 and 3 (in table IV.1a.Vol.2 resp. 53% and 73%) are high enough to indicate that both of them have an important role on the western wall. Consequently, the interpretation of these two facts is that they both are cultic in character, but that for each of them this cultic character is different.⁸ The division of cultic character type I into types Ia and Ib has been based on this difference (see figure VII.3).

⁵ LÄ, II, 856, s.v. "Grabdekoration" and LÄ, II, 867, s.v. "Grabrelief".

⁶ Weeks, *Art*, 59-60. His doubts are based on the problem of the emic/etic interpretation of the available information

⁷ The difference between the two (sub)themes is that (sub)theme 3 is the main focal point of the care taken "here" for those who live in the transcendental world of the "hereafter" (LÄ, V, 1128-1133, s.v. "Speisetischszene"), and thus functions as the main cultic "hereafter" (sub)theme. (Sub)theme 2 is the most important depiction of the daily life of the tomb owner with his family, and thus the main "here" (sub)theme. The fact that each of the (sub)themes could be placed on the western wall stresses the prime function of the western wall, that of forming a connection between the "hereafter" and the "here". Furthermore (sub)theme 2 (the main (sub)theme for the "here") is the most important during the start of the Old Kingdom, a function that is taken over by (sub)theme 3, the main "hereafter" (sub)theme. This indicates a change in the function of the western wall. Possibly a change about the idea of the *ka* of the deceased actually "living" in the interior of the burial chamber and the mastaba, using the false door as a connection between the "here" and the "hereafter". This is *not* the change as described by Allen (Allen, *Non-royal afterlife*, 9).

⁸ The term "cultic character" is introduced to describe the type of cultic role of the (sub)theme.

3. In chapters V and VI a possible unifying function has been deduced for (sub)themes 5, 7 and 10, a function which is non-cultic. The preliminary designation of type II has been given to this type of character.⁹
4. When (sub)theme 2 was placed on wall section 3 its function was a signalling/guiding one, consequently its cultic character was of type II. After its shift to wall section 2 it acquired a different cultic character, which changed from II to Ia (figure VII.4).
5. During a short period (sub)theme 1 (the tomb owner alone) was placed on the western wall and there solely on wall section 3 (table VI.1.Vol.2). The ground-plan of the cult chapels with this (sub)theme on the western wall, the location of the false door(s) and of (sub)theme 1 on the western wall and the orientation of the tomb owner, are compiled in figure VII.2. It is probable that (sub)theme 1, during its short period of employment, was placed on wall section 3 in order to be in front of the entrance, thus taking over the role of (sub)theme 2.¹⁰ Its role there might have been signalling/identifying and/or guiding,¹¹ indicating a cultic character of type II.

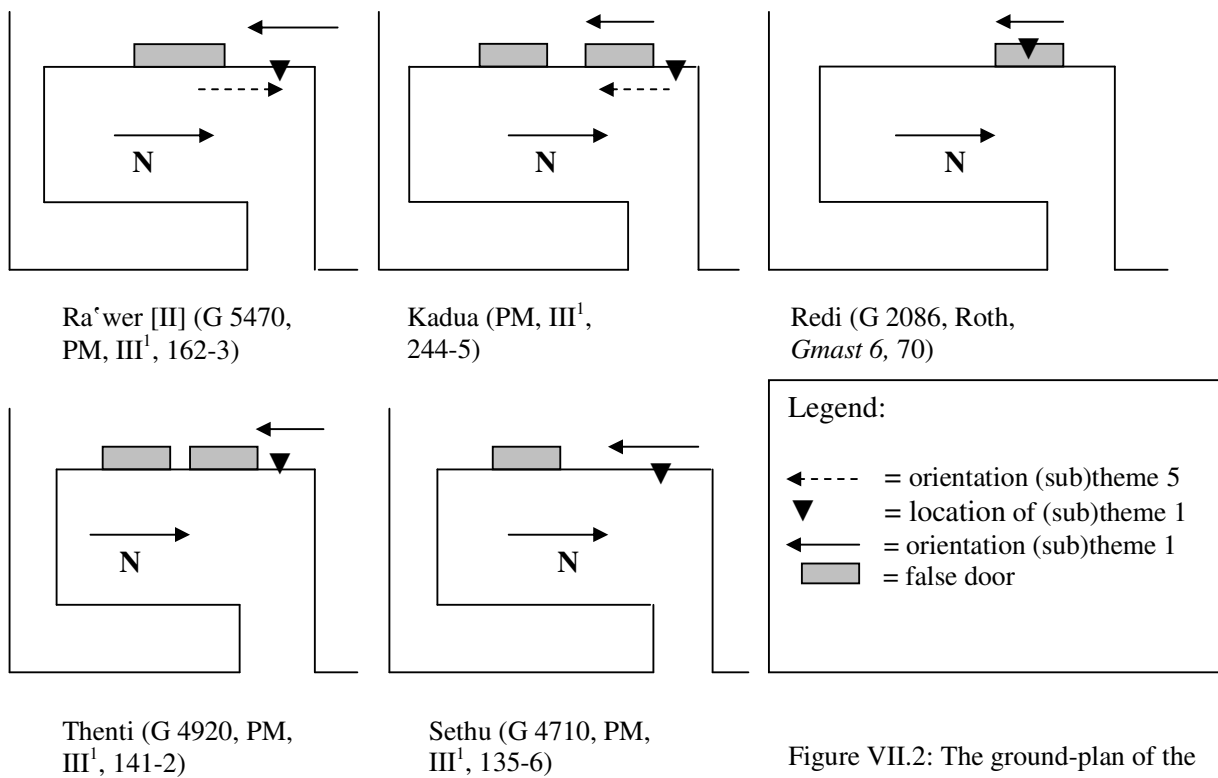

Figure VII.2: The ground-plan of the cult chapels with (sub)theme 1 on the western wall.

⁹ A further division of this type is given in figure VII.3.

¹⁰ Weeks, *Art*, 74.

¹¹ Decoration in the form of the standing tomb owner was placed at the entrance of the cult chapel (on the lintel, architraves, drums and entrance thicknesses) (Harpur, *DETOK*, 307-14). In the necropolis of Giza in 78% of the tombs mentioned (Harpur, *DETOK*, 307-8, table 4.7) the standing tomb owner was depicted on both sides of the entrance, a depiction placed there throughout the whole Old Kingdom. Probably the function of this entrance decoration was a signalling/identifying one; in that case the depiction on the entrance thicknesses was possibly meant to invite the passer-by to enter into the cult chapel. The depiction of the standing tomb owner on the western wall opposite the entrance was difficult to see for someone standing outside. As a consequence, it is probable that this depiction neither identified (although his/her name was stated next to it) nor invited into the chapel, but only "reminded" the visitor, by guiding him/her deeper into the chapel, either to recite the offering formula in front of the false door or to place an offering there (a guiding function).

In figure VII.3 a more precise description of the types of cultic character of (sub)themes, normally placed on the western wall, has been given.

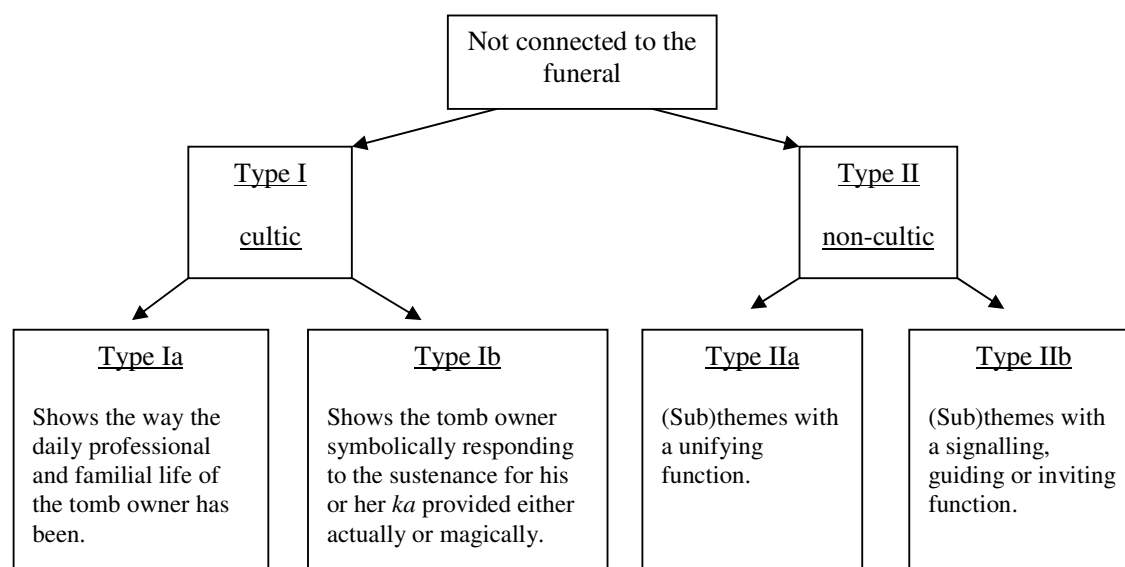

Figure VII.3: The description of the types of cultic character.¹²

II. The cultic character of (sub)themes 1, 2 and 3, and its chronological development.

(Sub)theme 1 = tomb owner sitting or standing alone.

(Sub)theme 2 = tomb owner in physical contact with members of the family.

(Sub)theme 3 = tomb owner at the offering table.

The chronological developments of (sub)themes 1, 2 and 3, as already discussed in chapter VI, part III, and the cultic character that can be allotted to them in the divers periods, is represented in figure VII.4.¹³ The increase in frequency of placement of (sub)theme 2 on wall section 2, was simultaneous with a decrease of its employment on wall section 3 (figures VI.6 and VII.4), and a change in cultic character from non-cultic type IIb to cultic type Ia.¹⁴

¹² In figures VII.1 and VII.3 a type II character is added to describe the “behaviour” of some (sub)themes. These (sub)themes are considered not to be directly necessary for the cult itself, yet, the fact they are to be found within the cultic surroundings of the western wall of the chapel gives them a role within the total setting of the cult. Some of these (sub)themes are designated to have a unifying function, which does not mean that this (sub)theme can be placed anywhere just to fill empty space. This type of (sub)theme is employed on account of its sense and the surroundings in which it is going to be placed. In the description of the type Ia cultic character, the “etic” theory that it is the representation of the after-life as the tomb owner hoped it to be (LÄ, II, 856, s.v. “Grabdekoration”) has been omitted, it has been added to the group with a cultic character because in the early Old Kingdom it was the main (sub)theme on the western wall and thus must have played a role in the active cult.

¹³ In figure VII.4 the abbreviation „sth“ stands for “(sub)theme”.

¹⁴ See also: LÄ, I, 293-9, s.v. “Anruf an Lebende” and LÄ, I, 815-21, s.v. “Biographie“, 815.

This in turn brought about the introduction (or the transfer from another part of the cult chapel) of a new (sub)theme, (sub)theme 1 (the tomb owner standing alone), on the section of the western wall which was in front of the entrance of the chapel.¹⁵

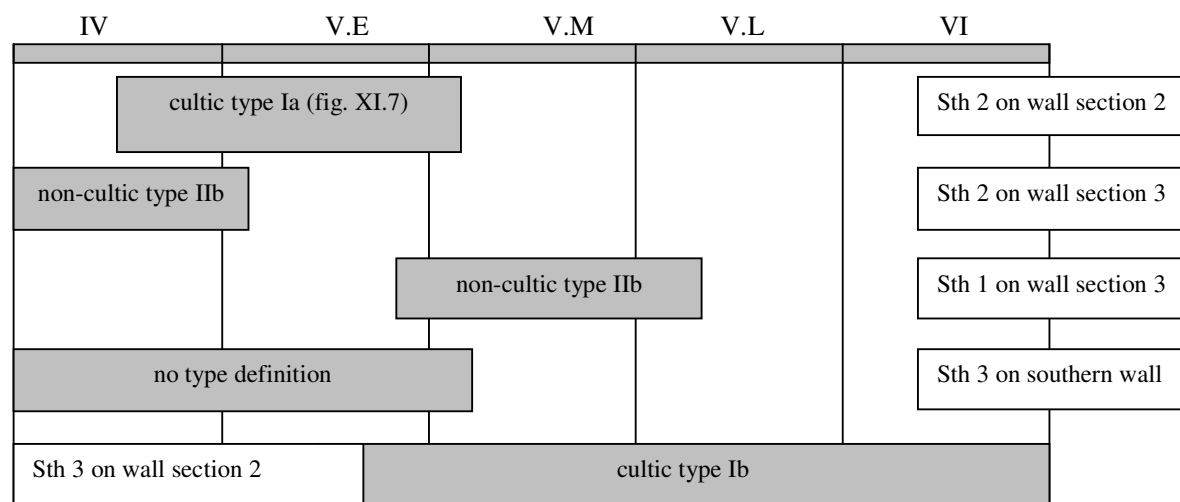

Figure VII.4: The cultic character of (sub)themes 1, 2 and 3 over time.¹⁶

The explanation for the falling into disuse of (sub)theme 1 on wall section 3 must be sought in a change in the cultic meaning of the chapel, which caused several alterations on the western wall, one of them being a shift of (sub)theme 1 from wall section 3 possibly to the thicknesses of the entrance, but a further study of this possible shift is beyond the scope of this research project.

During the period V.E/L – V.M/E (sub)themes 2 and 3 could be chosen for wall section 2, but never both at the same time (CP/SWS = 26/0 in table VI.2.Vol.2). If (sub)theme 2 is placed on wall section 2, (sub)theme 3 can only be found on the southern wall of the cult chapel (table VI.3.Vol.2). Throughout the whole Old Kingdom (sub)themes 2 and 3 were occasionally placed together on the western wall, but never on the same wall section (table VI.1.Vol.2).

A highly probable conclusion is that until V.M (sub)theme 2 was more adapted than (sub)theme 3 to the then prevailing convictions concerning the cult.¹⁷

¹⁵ Although the shift of (sub)theme 2 from wall section 3 to wall section 2 appears to bring about the nearly simultaneous falling into disuse of (sub)theme 6 (personified estates), at this stage of the research project it cannot (yet) be decided whether a direct connection exists between these two chronological developments.

¹⁶ The bars in this diagram only represent the period(s) with a higher frequency of employment of the (sub)themes. The renewed introduction of (sub)themes 2 and 8 in the repertoire of the decoration of the western wall during the 6th dynasty (see table VI.1.Vol.2) is discussed later in this chapter.

¹⁷ The preference for placing (sub)theme 3 either on the southern or on the western wall can be inferred from Harpur, *DETOK*, 65-73 where the frequency of employment of (sub)theme 3 on the four walls of the L-shaped cult chapels with one or two false doors has been given. The results are gathered in figure VII.5:

wall	total tombs	% sth 3	page	wall	total tombs	% sth 3	page
EW	45	0%	65	WW	68	44%	70
SW	46	41%	68	NW	40	18%	73

Figure VII.5: Distribution of (sub)theme 3 over the walls.

Figure VI.13 shows that a close connection exists between the decrease and increase in frequency of employment of respectively (sub)themes 2 and 3.

If (sub)themes 2 and 3 were both chosen from the repertoire, and if, furthermore, it was decided to place (sub)theme 2 on wall section 2, (sub)theme 3 was placed on the southern wall of the cult chapel. However, from early V.M on, (sub)theme 3 was increasingly placed on section 2 of the western wall, and at the same time it was less frequently placed on the southern wall.¹⁸

This might have been the reason for the marked decrease in the choice of (sub)theme 2 on wall section 2 and its disappearance from the western wall altogether. At this stage of the research project it is not possible to decide whether the change in location of (sub)theme 3 caused the strong decrease in the employment of (sub)theme 2 or vice versa; nor is it possible to decide why these changes took place.

The possible close connection of (sub)theme 2 with (sub)themes 6 and 8 is corroborated by their simultaneous decrease of placement on the western wall (figure IV.4).

III. Determination of the cultic character of the (sub)themes.¹⁹

1. (Sub)theme 3 (tomb owner at the offering table).

This (sub)theme can be considered to be the main cultic (sub)theme of the cult chapel.²⁰ In the division as proposed in figure VII.3, it has been assigned the cultic character of type Ib. The cultic character of the other (sub)themes is determined by the nature of their interaction with this (sub)theme.

2. (Sub)theme 1 (tomb owner alone).²¹

In (sub)theme 5 bearers are depicted while bringing offerings. The CP/SWS value of its interaction with (sub)theme 1 is 160/25 (8) (table VI.2.Vol.2) and this indicates that, although the (sub)themes are very often together on the western wall (due to the high FO value of 90% of (sub)theme 5) (table IV.1.Vol.2)), they are hardly ever together on the same wall section. Clearly the tomb owner, if depicted on wall section 3, has not been placed there with the primary cultic function of receiving food offerings (exceptions being the western wall of the tomb of Kadua (PM, III¹, 244-5), but there the tomb owner and the offering bearers are all directed to the northern false door (figure VII.2), and the western wall of the tomb of Ra'wer [III] (PM, III¹, 162-3), and here the offering bearers are oriented *toward* the tomb owner)). In spite of this one *real* exception, (sub)theme 1 is considered to of type IIb cultic character.

The CP/SWS value of its interaction with (sub)theme 4 (members of the family) is 20/0 (1), and this indicates that (sub)themes 1 and 4 together do not form a scene from the daily life of the tomb owner.²² The conclusion is that (sub)theme 1 has a character which is not directly connected to the cult itself, and that it is probably meant to show the tomb owner as a living person in a signalling/markings function or guiding visitors into the chapel; consequently its cultic character is of type IIb.

(the abbreviations “EW, SW, WW, NW” and “sth” stand for respectively: eastern wall, southern wall, western wall, northern wall and (sub)theme). This figure shows that (sub)theme 3 is preferentially placed either on the southern or on the western wall of the cult chapels.

¹⁸ Table VI.3.Vol.2.

¹⁹ All CP/SWS values mentioned are taken from table VI.2.Vol.2, and the CPSD values from figure VI.15.

²⁰ LÄ, VI, 711, s.v. „Toter am Opfertisch“ points out that this (sub)theme is the most important in the cult chapel. On the western wall its importance increased gradually to reach its maximum in V.L and VI (figure VI.13).

²¹ Because the (sub)theme is included in the repertoire only for a short period, the number of co-occurrences with other (sub)themes is small. This makes the interactions of (sub)theme 1 as given in table VI.2.Vol.2 unreliable.

²² Conclusions derived from the CP/SWS value of 20/0 are not reliable, because these values are based on only one co-occurrence.

3. (Sub)theme 2 (tomb owner with family).

The interaction between (sub)themes 2 and 3 has a CP/SWS value of 26/0 (7), from which it is feasible to conclude that the (sub)themes avoid each other strongly on the western wall, and if they are together on that wall it is never on the same wall section.

Because it has already been concluded that (sub)theme 2 is the focal point of a group that forms a scene out of the daily life of the tomb owner, its cultic character is of type Ia. The conclusion from the above mentioned arguments is that (sub)theme 2

1. has a type IIb cultic character, when placed on wall section 3.
2. has a type Ia cultic character, when placed on wall section 2.

During the transition from V.E/L to V.M/E the frequency of employment of (sub)themes 2 and 8 decreased. (Sub)theme 6 had already fallen into disuse at the end of V.E/L (This might indicate an association between (sub)themes 2, 6 and 8) (figure IV.4).

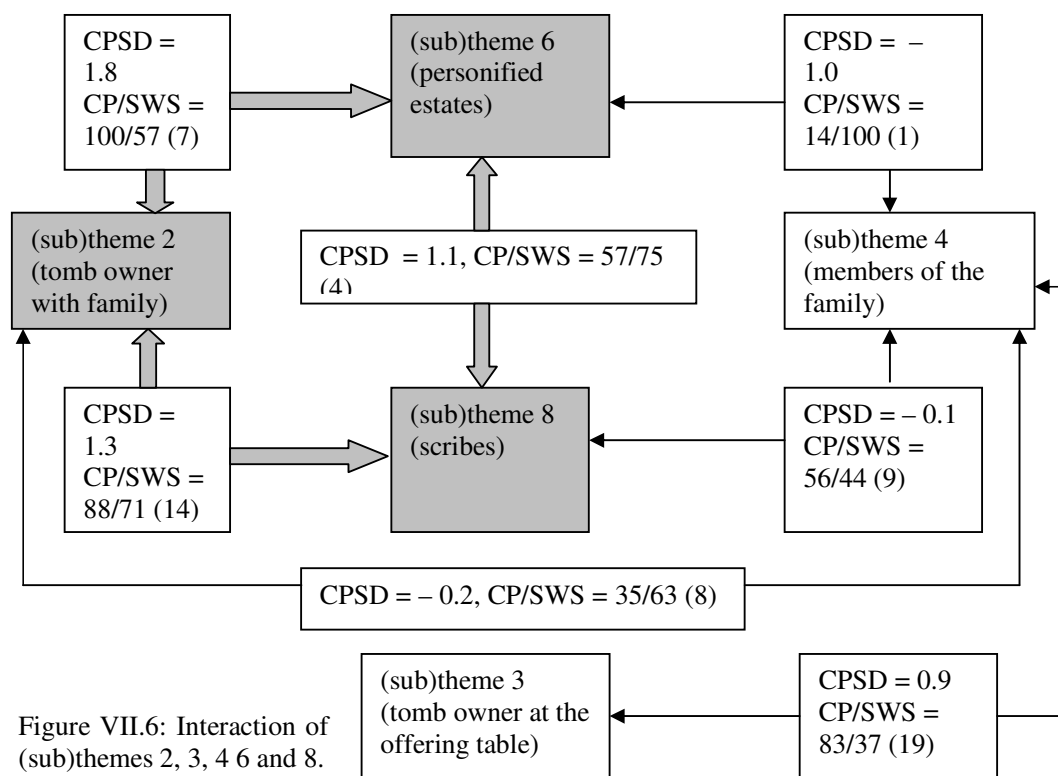

Figure VII.6: Interaction of (sub)themes 2, 3, 4, 6 and 8.

In figure VII.6 the CP/SDS and CP/SWS values of the interactions between the group of (sub)themes 2, 6 and 8 with (sub)theme 4 (members of the family) have been gathered.

The CP/SWS values of the interactions between (sub)themes 2 and 6 (100/57), (sub)themes 2 and 8 (88/71) and (sub)themes 6 and 8 (57/75) are, according to figure VI.16, all an association. The close connection between these three (sub)themes corroborates the argument that (sub)theme 2 is the focal (sub)theme of a scene, and judging from the subjects depicted, taken from the daily life of the tomb owner.

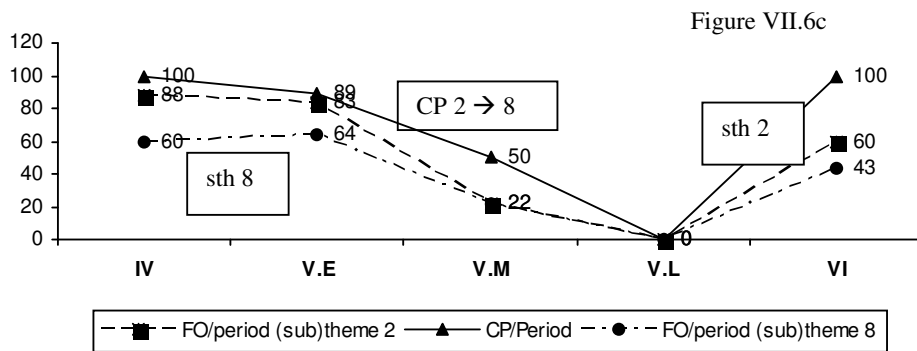
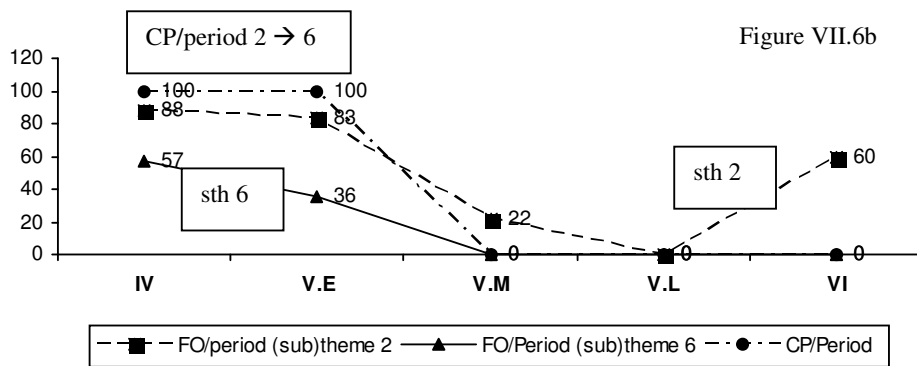
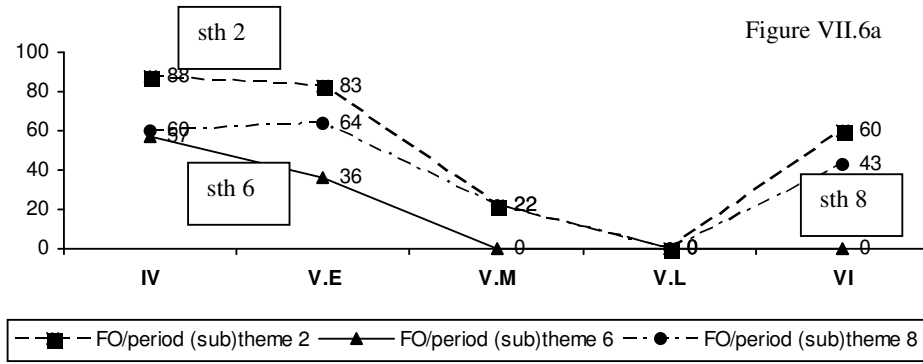

Figure VII.6a-b-c: Interactions between (sub)themes 2, 6 and 8 in connection with their CP curves.

Proof for the group formation of (sub)themes 2, 6 and 8 comes from the considerations as discussed in chapter III, section VI.2. That these three (sub)themes form a group is shown in figures VII.6a, VII.6b and VII.6c (values determined in table VI.1.Vol.2, the combinations being counted as the number of placements they contain) where the FO/period values of (sub)theme 2, 6 and 8 are compared with the CP/period values of the interaction between (sub)themes 2 and 6 and between 2 and 8. In figures VII.6b and VII.6c the adequate CP/period and FO/period diagrams are compared and the diagrams resemble each other enough to conclude that the three (sub)themes form a group.

The CP/SWS values of the interactions between (sub)theme 4 and (sub)themes 2, 6 and 8 (resp. 35/63 (8), 14/100 (1) and 56/44 (9)) indicate that (sub)theme 4 does not belong to the group of (sub)themes

2, 6 and 8. The aberrant CP/SWS value of the interaction between (sub)themes 4 and 6 (14/100) is due to a small overlap in time which results in only one co-occurrence.

(Sub)theme 5 has the highest FO value (90% in table IV.1a.Vol.2) and can be combined with any of the (sub)themes (all interactions of (sub)theme 5 have a positive CPSD value).²³

If in table VI.1.Vol.2 the CP value of the interaction between (sub)themes 2 and 5 on wall section 3 is determined for period IV, the CP value is 0%. Consequently, if placed on wall section 3, no offering bearers are present around (sub)theme 2, and apparently its role on that wall section is such that the reception of food offerings is unnecessary or even unwanted. This supports the already proposed hypothesis that on wall section 3 the cultic character of (sub)theme 2 is of type II (in figure VII.4 given as IIb).

However, from period V.E on (sub)theme 2 is placed on wall section 2 with an appreciable frequency (figure VI.12), and the CP/SWS value of its interaction with (sub)theme 5 during period V.E becomes 144/38.²⁴ This indicates that the cultic character of (sub)theme 2 on wall section 3 differs from its cultic character on wall section 2.

If this is compared with the interaction of (sub)themes 3 and 5 for the period V.E with a CP/SWS value of 175/57,²⁵ it could be concluded that during that period the cultic characters of (sub)themes 2 and 3 on wall section 2 were identical (type Ib), but this conclusion would be invalid because table VI.2.Vol.2 shows that the unifying function of (sub)theme 5 has no specific preference for a certain cultic character.

As already discussed, the original meaning of the western wall of the chapel was to form a connection between the “hereafter” and the “here”. At first it was the depiction of the tomb owner with his family that was placed there with this function and the pertaining type Ib cultic character. The moment this function was gradually taken over by (sub)theme 3, it also adopted this cultic character.

(Sub)theme 2 falls into disuse at the transition from V.M to V.L, but is reinstated during the 6th dynasty. Possible reasons for this reinstatement are discussed in part V of this chapter.

The positive CPSD values and the CP/SWS values of the interactions between (sub)themes 2, 6 and 8 (in figure VII.6 marked in grey) show that the three (sub)themes can be placed on the same wall section at the same time and that there is a strong probability that they form a group (a scene).

4. (Sub)theme 4 (members of the family).

The CP/SWS values of the interactions between (sub)themes 2 and 4 and also between (sub)themes 3 and 4 are determined for the different periods (figure VII.7).

In the period V.E -V.M, based on the SWS value of the interaction, an association exists between (sub)themes 2 and 4 (SWS = 71%), while in the same period (sub)themes 3 and 4 have a dissociation (SWS = 36%). The conclusion is that in the period V.E – V.M (sub)theme 4 is of type Ia.²⁶

²³ In figure VI.15 the only interaction with a negative CPSD value is the one between (sub)themes 5 and 6 (CPSD = - 0.3). As already discussed, in figure VI.16 the location of the CP/SWS point of the interaction (100/29) (7) indicates that their interaction is in reality an association.

²⁴ This value is determined in table VI.1.Vol.2. in the normal way. There are in total 5 co-occurrences on the same wall section and all of them are on wall section 2.

²⁵ The SWS value is determined by 7 co-occurrences of which 4 are on the same wall section (2 on wall section 2 and 2 on wall section 3).

²⁶ The number of co-occurrences of (sub)themes 3 and 4 is determined from table VI.1.Vol.2.

	IV	V.E	V.M	V.L	VI
(sub)theme 2	Ia / Ib	Ia			Ib
		CP/SWS = 63/71			CP/SWS = 20/0
(sub)theme 4		Ia	Ia	Ia	Ia
		CP/SWS = 85/36		CP/SWS = 89/38	
(sub)theme 3		Ib	Ib	Ib	Ib

Figure VII.7: Determination of the cultic character of (sub)theme 4.

In the period V.L-VI the CP/SWS value of 89/38 of the interaction between (sub)themes 3 and 4 indicates a placement in the transitional area of the diagram in figure VI.16; therefore it is not possible to decide on the type of cultic character during that period..

The SWS value of 20/0 of the interaction between (sub)themes 2 and 4 in the period VI is based on one co-occurrence, and thus unreliable, but might indicate a type Ia cultic character. The tentative conclusion is that the cultic character of (sub)theme 4 is of type Ia..

5. (Sub)theme 5 (offering bearers).

The FO of this (sub)theme is high (90% in table IV.1a.Vol.2) and the interactions with all the other (sub)themes have positive CPSD values and can be considered to be associations.²⁷

Other methods have provided additional evidence that the (sub)theme has a unifying function. This means that the cultic character of (sub)theme 5 is of type IIa.

6. (Sub)theme 6 (personified estates).

This (sub)theme most likely forms a group with (sub)themes 2 and 8.

The interaction of (sub)theme 3 and 6 (type Ib) with CPSD = - 1.4 and CP/SWS = 0/0 is a strong dissociation.

The interaction with (sub)theme 2 is more complicated because the latter has more than one character. During period IV (sub)theme 2 is of type IIb, the CP/SWS = 100/25 indicating an association, and a cultic character of type IIb *seems* appropriate for (sub)theme 6; however, whenever (sub)theme 2 is on wall section 3, (sub)theme 6 has no co-occurrence on the same wall section with it. The CP/SWS = 100/100 during period V.E also indicates an association. During this period the only SWS co-occurrences that occur between the two (sub)themes take place on wall section 2.

The conclusion is that the cultic character of (sub)theme 6 is of type Ia, the same as the type of (sub)theme 2 on wall section 2. This is logical because on wall section 2 (sub)theme 2 is the focal (sub)theme of a group, but on wall section 3 it just has a signalling/guiding function, and cannot be part of a group.

²⁷ As already mentioned the only exception is the interaction between (sub)themes 5 and 6 (CPSD = - 0.3, figure VI.15). However the CP/SWS value of 100/29 (7) is marked in figure VI.16 and clearly indicates an association between the two (sub)themes.

7. (Sub)theme 7 (priests).

The possibility of (sub)theme 7 having a unifying function has already been mentioned. If the CP/SWS value is determined for every period for the interactions of (sub)theme 7 with (sub)themes 2 and 3 figure VII.8 is obtained. The interactions of the (sub)theme indicate a cultic function of type Ib. The problem is that in the period VI the CP/SWS is such (57/50 (4)) that an dissociation is indicated (which would lead to a type Ia cultic character). However, this is refuted by the much higher CP/SWS of 114/63 (8) of the interaction of (sub)themes 3 and 7 indicating a type Ib cultic character during period VI.

	IV	V.E	V.M	V.L	VI
(sub)theme 2	Ia / IIb	Ia			Ib
CP/SWS = 100/33	CP/SWS = 109/25				CP/SWS = 57/50
(sub)theme 7	Ib	Ib	Ib	Ib	Ib
		CP/SWS = 92/58		CP/SWS = 107/67	
(sub)theme 3		Ib	Ib	Ib	Ib

Figure VII.8: Determination of the cultic character of (sub)theme 7.

8. (Sub)theme 8 (scribes).

Its interaction with (sub)theme 3 (CPSD = - 0.8, CP/SWS = 25/0 (4)) indicates an dissociation. This dissociation is in agreement with the association of (sub)theme 8 with (sub)theme 2 (CPSD = 1.3, CP/SWS = 88/71 (14)).

	IV	V.E	V.M	V.L	VI
(sub)theme 2	Ia/IIb	Ia			Ib
	CP/SWS = 100/0	CP/SWS = 82/78			CP/SWS = 100/100
(sub)theme 8	Ia/IIb	Ia			Ib

Figure VII.9: Determination of the cultic character of (sub)theme 8.

The (sub)theme is part of the group formed by (sub)themes 2, 6 and 8. The (sub)theme falls into disuse at the transition from V.M/E to V.M/L, but is restored to the repertoire at the start of the 6th dynasty. The determination of the CP/SWS values per period shows that the cultic character of (sub)theme 8 remains identical with that of (sub)theme 2 during the whole Old Kingdom (figure VII.9).

9. (sub)theme 9 (the butchery scene).

The CPSD value of the interactions of this (sub)theme with (sub)themes 2 (CPSD = -0.3 , CP/SWS = 37/40 (10)) and 3 (CPSD = -0.6 , CP/SWS = 67/65 (20)) are determined.

Although the CPSD values indicate an dissociation, in figure VI.16 the location of the CP/SWS values of the interaction between (sub)themes 3 and 9 indicates an association, while that of the interaction between (sub)themes 2 and 9 indicates an dissociation.

The conclusion is that (sub)theme 9 has a type Ib cultic character.

10. (Sub)theme 10 (piles of food offerings).

The values of the interaction with (sub)theme 2 (CPSD = -1.7 , CP/SWS = 11/33 (3)), might indicate a strong dissociation, but they are based on a small overlap in time.

The interaction with (sub)theme 3 (type Ib, CPSD = 1.8, CP/SWS = 88/67 (30)), indicates an association, and if the interaction is determined from the introduction of (sub)theme 10 (V.M/E), then the CP/SWS is 103/67, even stronger indicating an association. Consequently, a preliminary conclusion is that the cultic character of (sub)theme 10 is of type Ib.

In section IV.2 of this chapter a probable unifying function of the (sub)theme is discussed, but from the CPSD values of its interactions with the other (sub)themes it cannot be firmly concluded (figure VI.15).

Based on the SWS values of its interactions such a function could be proposed, but there are strong indications that it exerts this function only in the vicinity of a limited number of (sub)themes.²⁸

The (sub)theme is introduced later in the period V.M/E (table VI.1.Vol.2), and the tendency for it to be placed only in the vicinity of certain (sub)themes suggests the following:

1. Its purpose was not primarily just unifying, because in that case it would already have had a high frequency of employment from the start of the 4th dynasty; as was the case for (sub)theme 5. Possibly it has been introduced to act as an unifying (sub)theme in a context that was different from that in which (sub)theme 5 was originally placed from the start of the 4th dynasty on.
2. The period during which it was introduced on the western wall is also the period for which later on in this research project, a change in the way of functioning of the cult chapel (or at least its western wall) is proposed. There is a change from the direct supply of food for the *ka* of the deceased by means of cultic activities in front of the false door, to a more magical food

²⁸ In table VI.1.Vol.2 are determined the CP/SWS values of the interactions of (sub)theme 10 with the (sub)themes with which it has an overlap in time (3, 4, 5, 7, 9 and 11) and also for (sub)themes 2 and 8, but only during the period(s) of the use life of these (sub)themes. The result is that the CP/SWS values of the interactions of (sub)theme 10 with (sub)themes 2 and 8 are so much lower that there is a strong indication that there is a restriction to place (sub)theme 10 in the vicinity of the (sub)themes 2 and 8 (figure below). This corroborates not only the different character of these two (sub)themes, but also the statement that (sub)theme 10 could only be placed in the vicinity of a selected number of (sub)themes.

interaction	CP/SWS	interaction	CP/SWS	interaction	CP/SWS
3 → 10	103/67	9 → 10	110/64	2 → 10	38/33
4 → 10	115/40	11 → 10	96/59	8 → 10	67/50
7 → 10	95/65	6 → 10	---		

supply by means of an increased frequency of the depicting thereof on the western wall.²⁹ (Sub)theme 10 has been introduced to increase the quantity of magical food depicted on the western wall, and thus acts as a unifying (sub)theme.

The conclusion is that the character of (sub)theme 10 has to be considered to be of type IIa.

11. (Sub)theme 11 (the non-ideographic offering list).

The interaction with (sub)theme 2 has CPSD = - 2.1, CP/SWS = 4/100 (1), indicating a strong dissociation, is probably caused by their brief chronological overlap.

This is confirmed by the interaction with the other members of the group, (sub)themes 6 and 8 (respectively CPSD = - 1.1, CP/SWS = 0/0 (0)) and CPSD = - 1.2, CP/SWS = 6/100 (1)), in both cases indicating an dissociation.

The interaction with (sub)theme 3 (CPSD = 1.3, CP/SWS = 96/68 (25)), indicates an association. The conclusion is that the cultic character of (sub)theme 11 is of type Ib.

In figure VII.10 a summary of the cultic character of the (sub)themes on the western wall is given.³⁰

(sub)theme	type	type	(sub)theme	type	type
1	IIb		6	Ia	
2	IIb	Ia/Ib	7	Ib	
3	Ib		8	IIb	Ia/Ib ³¹
4	Ia		9	Ib	
5	IIa		10	IIa	
			11	Ib	

Figure VII.10: A compilation of the cultic character of the (sub)themes on the western wall.

IV. The unifying function of (sub)themes.

In chapter VI the unifying function of (sub)theme 5 became certain, and although at first (sub)themes 7 and 10 were assigned the same function, but this has been proved impossible for (sub)theme 7 (for this reason it has been assigned the type Ib cultic character based on CP/SWS values and not a type IIa cultic character).

In order to have a more profound insight into this function, in the diagram of figure VI.16 the CP/SWS points of the interactions of (sub)themes 5 and 10 with (sub)themes with a type Ia or Ib cultic character are indicated by means of an area. In figure VII.10 it is evident that only 6 (sub)themes have either a type Ia or type Ib cultic character (3, 4, 6, 7, 9 and 11), and these are the only interactions that are introduced into the diagrams.

²⁹ LÄ, II, 532, s.v. « Gerätefries » stated that the depiction in the chapel of the goods that were considered to be necessary for life after death started late in the Old Kingdom. This was based on the idea that magic caused the depiction of the thing to become the thing itself. An example is the *Gerätefries* (Taylor, *Coffins*, figures 6-8). LÄ, III, 1137-1151, s.v. « Magie » claims that magic belief in the efficacy of funerary implements is an ultimate resort..... There are rare glimpses of the conviction that such material care is substituted by the magic force itself (CT, IV, 232).

³⁰ The conclusion about the type Ib cultic character of (sub)themes 2 and 8 during the period VI has already been incorporated in figure VII.9.

³¹ The cultic character of (sub)theme 2 depends on wall section and chronological period (see figure VII.18), the cultic character of (sub)theme 8 only on the latter..

IV.1. The unifying function of (sub)theme 5 (offering bearers).

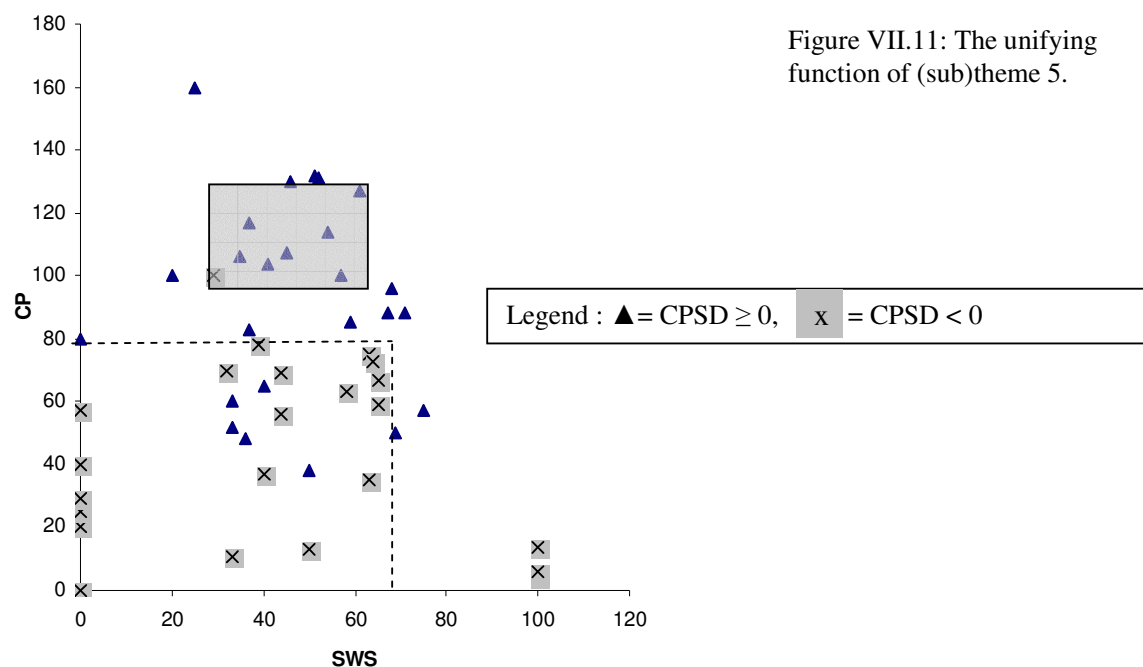

Figure VII.11: The unifying function of (sub)theme 5.

In the diagram of figure VII.11 the CP/SWS values of the admitted interactions of (sub)theme 5 are marked as an area in grey. This area is located high in the part of the diagram that represents overall association.

IV.2. The possible unifying function of (sub)theme 10 (piles of food offerings).

From table VI.2.Vol.2 all the CP/SWS values of the interactions of (sub)theme 10 with the other (sub)themes (table VI.2.Vol.2) are marked in the grey area in figure VII.12.

Because (sub)theme 10 has been introduced on the western wall starting period V.M, it is also possible to calculate the CP/SWS from that period on (figure VII.13).³²

³² The values determined are given in the table below. Because the CP/SD values have not been determined, the symbol used for the points is without the meaning it has in figures VII.11, VII.12 and VII.14.

interaction	CP/SWS	interaction	CP/SWS
3 → 10	103/67	9 → 10	110/64
4 → 10	115/40	11 → 10	96/59
7 → 10	95/65	6 → 10	---

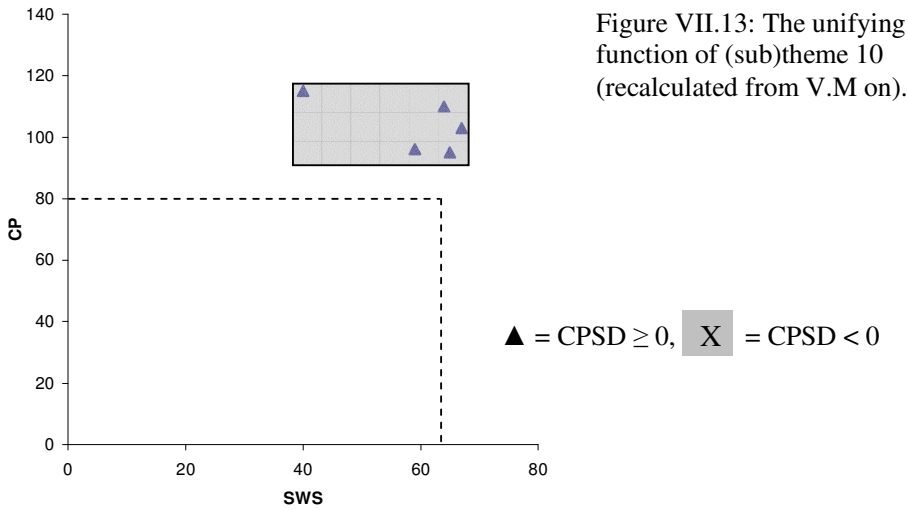
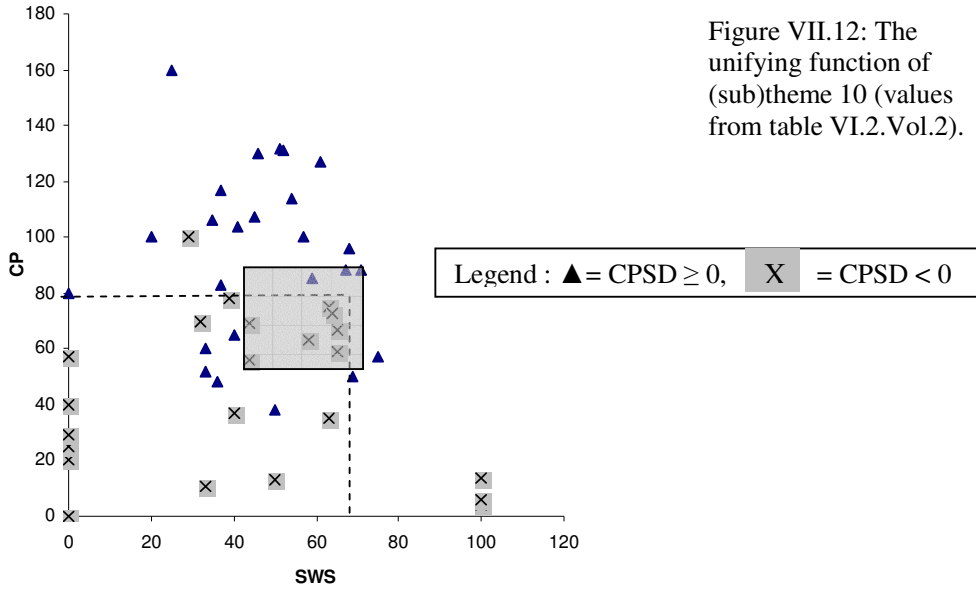

IV.3. The possible unifying function of (sub)theme 7 (priests).

In the same way, from table VI.2.Vol.2 the CP/SWS values of the interactions of (sub)theme 7 with the other (sub)themes are marked as an area with a grey filling in figure VII.14.

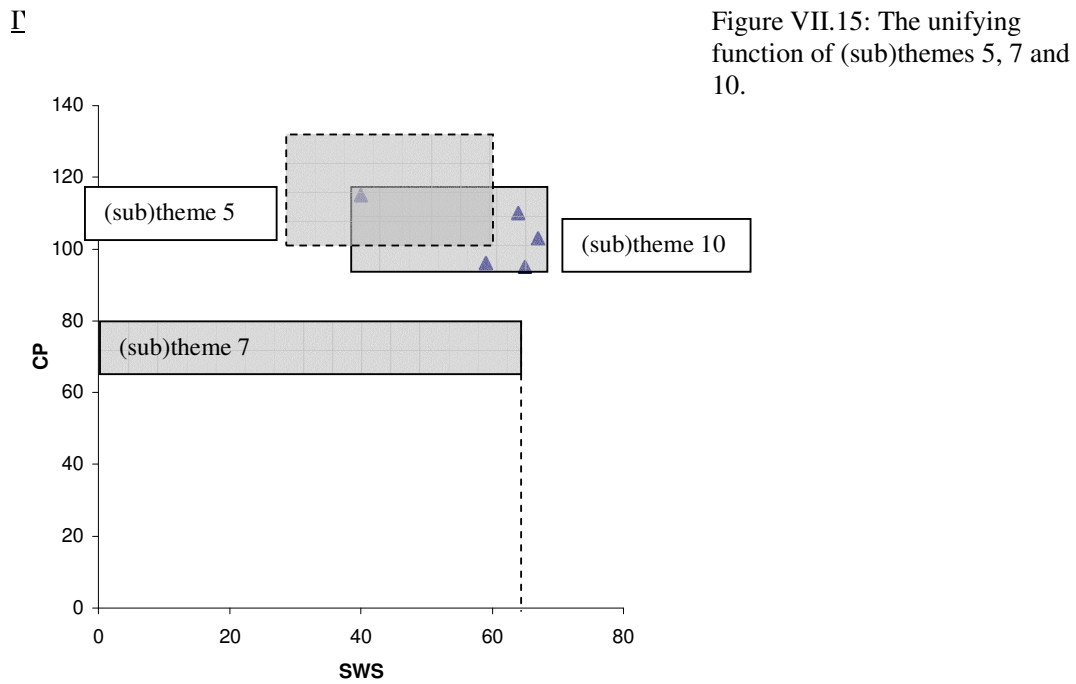
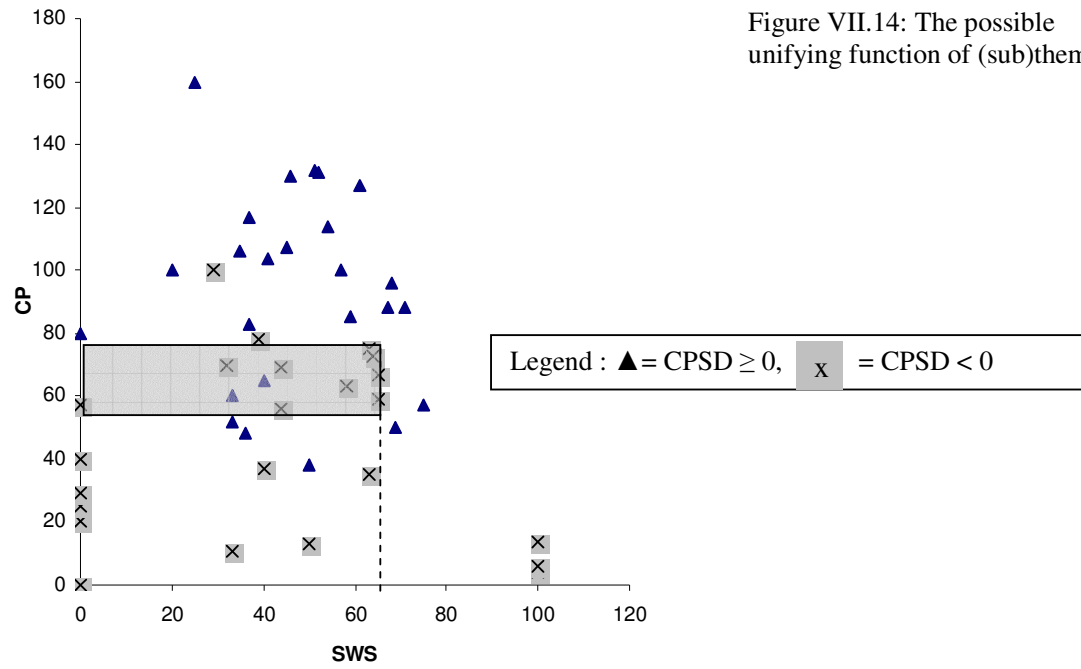

In figure VII.15 it is evident that the area of (sub)theme 5 and the corrected area of (sub)theme 10 are nearly identical, and form small clusters of points. The area of (sub)theme 7 differs completely from

the former two by being on a much lower CP level and furthermore, the cluster formed by the points is much larger and spread out over a much large area of SWS values.

The interpretation of the resulting diagram is that, like (sub)theme 5, (sub)theme 10 has a unifying function, but that this is not the case for (sub)theme 7.

V. The chronological development of the cultic character of the western wall.

The period(s) of frequent appearance (the use life) of the (sub)themes and the chronological development of the changes of character is (are) determined on the basis of table VI.1.Vol.2 and gathered in figure VII.17.³³

In order to make the chronological developments more evident, each main period is divided into two subperiods, respectively “early (= first half)” and “late (= second half)”.³⁴

For (sub)themes 2 and 8 the period V.M/L – VI is problematic and three explanations are possible for their reinstatement of (sub)themes 2 and 8 during period VI:

1. The placing of (sub)themes 2 and 8 as (sub)themes of type Ia continued in the period V.M/L – V.L/L (the period without placements (seriation IV.1.Vol.2)), but in this period an unusually high percentage of tombs is incomplete due to “emic” or “etic” interference.
2. The employment of the two (sub)themes does not continue after the transition from V.M/E to V.M/L but it is, due to an archaising trend at the end of the Old Kingdom, reinstated with the same cultic character (Ia) in period VI.
3. The appearance of the two (sub)themes as (sub)themes of type Ia ended at the transition from V.M/E to V.M/L, and at the start of the period VI they were reinstated, but, due to a change that had taken place in the cultic meaning of the western wall of the chapel, now with a type Ib cultic character.

The first option is improbable because if in table IV.1a.Vol.2 the percentage of tombs with an incomplete western wall is determined per period, a curve is obtained with a perfect polynomial fit

³³ The definition of the term “use life (of a (sub)theme)” involves a problem, because it can be defined in two ways:

1. The whole period in which the (sub)theme under study is apparent is included in the use life, even when in part of that period the number of its occurrences is markedly inferior to that in the rest of the period.
2. For the whole period of appearance only that part in which the (sub)theme has a frequency of employment exceeding a certain value is included in the study (with the inherent problem of defining that certain value).

The disadvantage of the first definition is that the importance of a small number of occurrences is strongly exaggerated compared to the others. Because, in this research project, a chronological order of occurrences of a (sub)theme is followed, in consequence the accuracy of their datings would be strongly overrated. Also the impact of the free will of human beings would be too marked, because a tomb with a, for that period, divergent repertoire, would also exert its influence.

The disadvantage of the second definition is the obvious necessity to define the degree of frequency with which an occurrence becomes accessible to the research project.

However, it must be realised that, up to this stage, the research project has been based on (archaeological) data whose reliability is less than 100%. Consequently, defining a scale of accessibility of occurrences based on degrees of frequency would lead to (probably erroneous) conclusions obtained from the application of a tool with an inherent high degree of accuracy to data whose reliability is strongly inferior. The consequence is that those periods in which a (sub)theme occurs only once or twice are **not** included as part of its use life.

The FO/period diagrams of some (sub)themes show a low frequency of employment over a certain period, followed by a sharp increase (see diagram IV.10.Vol.2). In modern parlance this period of low frequency could be called “trend setting”, followed by a period of high popularity. This principle is visible in the onset of the shift of (sub)theme 3 from the southern to the western wall in figure VI.13.

³⁴ This division is not based on a predetermined point in the period.

(figure VII.16). In this curve the high percentage of incomplete tombs in the period IV followed by the decrease in periods V.E and V.M can easily be explained by the increasing number of years of exposure. The increase during the periods V.L and VI can be explained by an increasing impoverishment of the building materials used for the tombs built during these periods. In this curve

the values for the period V.M/L – V.L/L are in perfect match with the rest of the curve. This indicates that in this period the percentage of incomplete tombs is not exceptionally high.

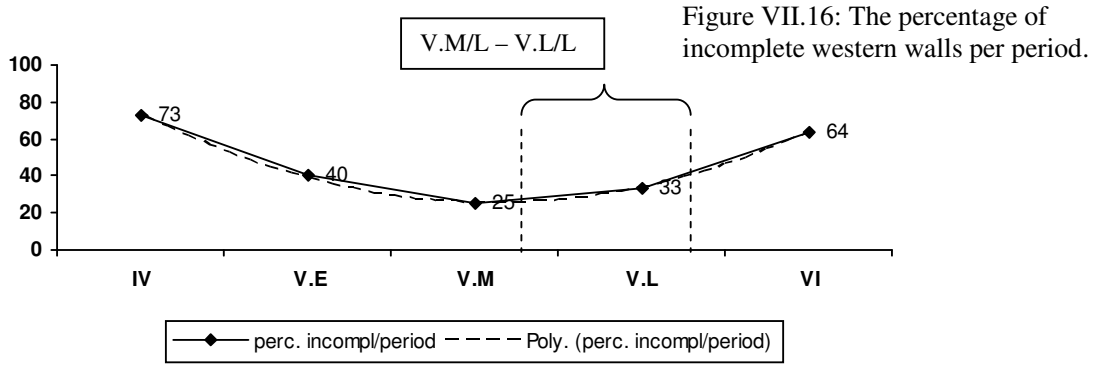

Figure VII.16: The percentage of incomplete western walls per period.

The second option mentioned is also improbable, because the first archaizing period mentioned in literature is the 12th dynasty.³⁵ The possibility of an archaizing trend in the period under study is also rejected by Cherpion.³⁶

The fact that in figure VII.6c the CP curve of the interaction between (sub)themes 2 and 8 matches both the curves of the FO/period of these (sub)themes, can be regarded as proof of the type Ib cultic character of (sub)theme 8 during period VI, and this makes the third option more probable than the first two mentioned.³⁷

(sub)theme	IV		V.E		V.M		V.L		VI	
	early	late	early	late	early	late	early	late	early	late
1										
2	■	■								
3										
4										
5	■	■								
6	■	■								
7	■	■								
8	■	■								
9	■	■								
10										
11										

Figure VII.17: A compilation of the chronological development of the (sub)themes.

■ = presence of the (sub)theme

The complicated cultic character of (sub)theme 2 during the period IV – V.E is shown in figure VII.18. During period VI the cultic character of (sub)themes 2 and 8 is taken to be of type Ib, while

³⁵ LÄ, I, 388, s.v. “Archaismus” mentions the 19th dynasty as the first period of archaism. However, Aldred, *Art*, 111, 115 and 118 mentions the 11th dynasty as the start of the first such period of archaism and so does Stevenson Smith, *Art and Architecture*, 158.

³⁶ Cherpion, *Mastabas*, 103.

³⁷ This statement is not completely reliable, because in table VI.1.Vol.2 the CP/SWS values of the interactions of (sub)theme 8 with (sub)themes 9 and 11 during period VI do not strongly support this type Ib character of (sub)theme 8 during period VI (8 → 9 CP/SWS = 67/50, 8 → 11 CP/SWS = 33/100). Yet, the interactions of (sub)theme 4 (type Ia) with (sub)themes 2 and 8 do so strongly (interaction sth 2 → 4 CP/SWS = 20/0; sth 8 → 4 CP/SWS = 33/0).

during the period V.E both of them are of type Ia. (Sub)themes 2 and 8 fell into disuse in their type Ia cultic character during the transition from V.M/E to V.M/L, but for possible reasons that are discussed at a later stage of the research project, they are reinstated in the 6th dynasty, but this time with a type Ib cultic character.

In figure VII.18 the periods of the highest frequency of employment of the (sub)themes (see figure VII.17) are gathered showing their cultic character, and the changes thereof.

The frequency of each cultic character is determined per period, and in figure VII.19 these values are gathered in a diagram.

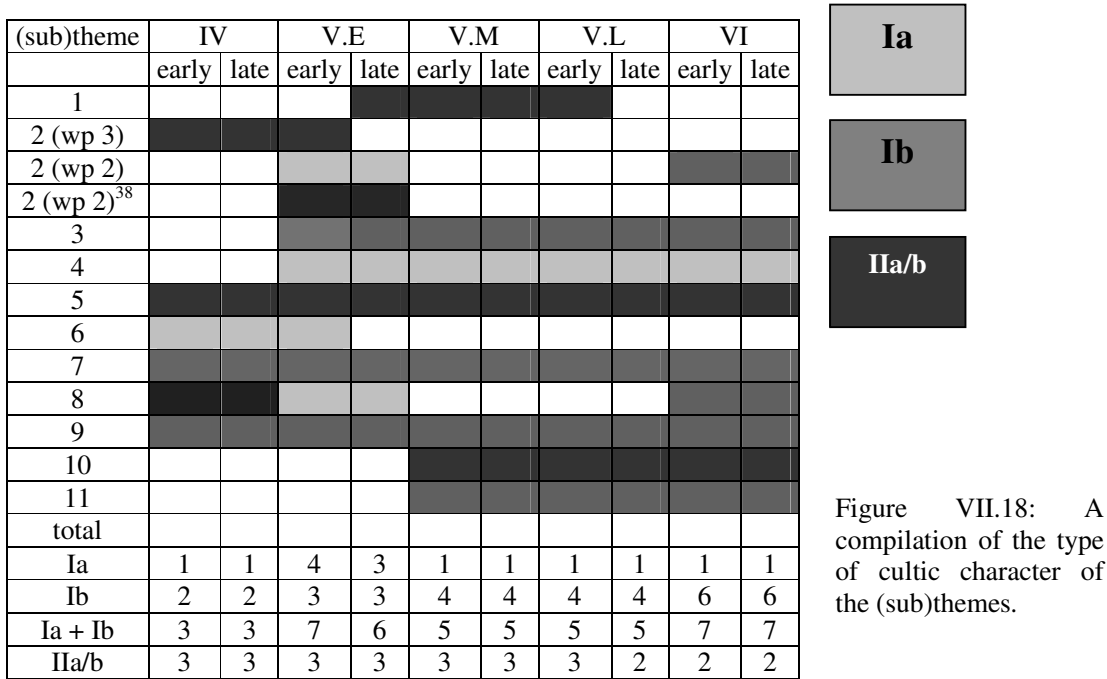

Figure VII.18: A compilation of the type of cultic character of the (sub)themes.

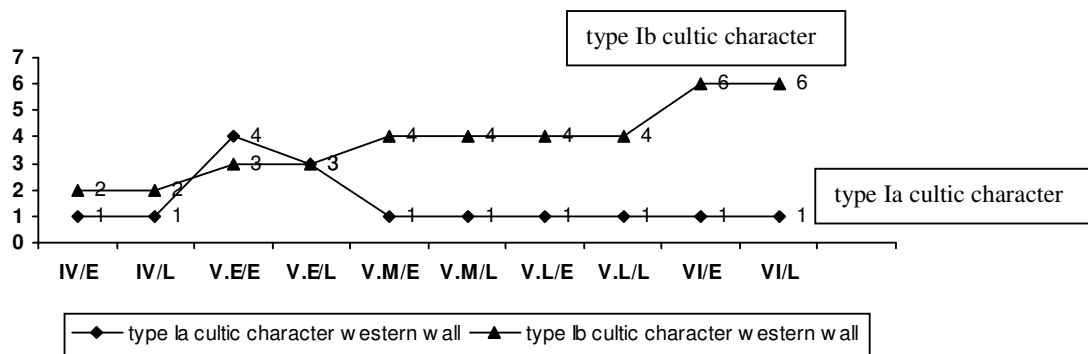

Figure VII.19: The chronological development of types Ia and Ib cultic character.

The chronological developments of the two types of cultic character are closely related, because from V.E/E on the frequency of employment of (sub)themes of type Ib increases, and, after an initial increase, the frequency of employment of (sub)themes of type Ia starts to decrease in the same period. It is the somewhat doubtful cultic character of (sub)theme 4 that causes the type Ia cultic character to remain present on the wall.

³⁸ For this cultic character of (sub)theme 2 see : Chapter XI.

The chronological development for type IIa/b as given in figure VII.20 shows that there are no dramatic changes in the number of (sub)themes with a type II a/b cultic character and it can be considered to be stable throughout the whole Old Kingdom.

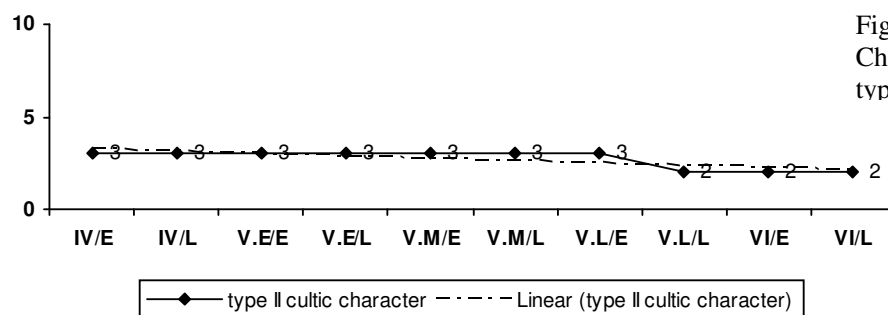

Figure VII.20 :
Chronological development
type II cultic character.

VI. Preliminary conclusions.

1. The main alteration on the western wall is the shift of (sub)theme 2 from wall section 3 to wall section 2 with a simultaneous change in the cultic character of the (sub)theme. This shift is, somewhat later, followed by the (sub)theme falling into total disuse.
2. (Sub)theme 2 forms a group with (sub)themes 6 (personified estates) and 8 (scribes). When (sub)theme 6 falls into disuse (end of period V.E/E), the other two (sub)themes continue to be placed on the western wall until early in the period V.M.
3. At the start of the 6th dynasty (sub)themes 2 and 8 are reinstated on the western wall, but their cultic character changes from type Ia to type Ib.
4. (Sub)themes 2 and 3 are incompatible, in the sense that, although it is possible for them to occur together on the same wall, they are not found together on the same wall section.
5. In figure VII.11 the cluster of points of the interactions of (sub)theme 5 (offering bearers) has high CP and SWS values, combined with a low spread, thus forming a compact cluster. The same is true for the cluster of (sub)theme 10 in figure VII.13 which is, however, placed around somewhat lower CP/SWS values than the cluster of (sub)theme 5. The cluster of (sub)theme 7 (figure VII.14) is placed at even lower CP/SWS values and has a bigger spread. The conclusion is that (sub)theme 7 has no unifying function.
6. Although (sub)themes 5 (offering bearers) and 10 (piles of food offerings) seem to be closely related, in reality they are not, because they serve two completely different purposes in the western wall. (Sub)theme 5 has a unifying function and has been employed as such from the start of the 4th dynasty on. (Sub)theme 10 is introduced from V.M on with a function of magical food supply for the *ka* of the deceased and it is preferably placed around (sub)themes that are connected to this type of supply of food that in that period changed from practical with a magical background to mainly magical. As such it has a unifying function.
7. Taking into account the placement of (sub)theme 1 in front of the entrance of the chapel in figure VII.2, a signalling/guiding role for this (sub)theme is probable.³⁹
8. (Sub)themes 2, 6 and 8 form a scene from the daily life of the tomb owner. (Sub)theme 6 is the first to disappear and (sub)theme 4 (members of the family) appears to take over the role of (sub)theme 6 (personified estates), transforming the group from (sub)themes 2, 6 and 8 into (sub)themes 2, 4 and 8. If indeed (sub)theme 4 is part of that group it would have a close

³⁹ An objection to this proposition could be that a passer-by, standing in direct sunlight in front of the entrance, could not see the figure of the tomb owner on the wall opposite the entrance. However, the glare of the light on the sand in front of the chapel entrance must have reflected some light into its interior. Furthermore lamps or torches could be lit if it was necessary to go deeper into the interior.

- connection with (sub)themes 2 and 8. However, no proof has been found for this,⁴⁰ and also the fact that after the disappearance of (sub)themes 2 and 8, (sub)theme 4 continues to be placed on the western wall corroborates that (sub)theme 4 does not take over the role of (sub)theme 6.
9. In figure VII.19 it is evident that for both type Ia as type Ib cultic character an increase set in during V.E/E. It was in V.E/L that for type Ia a decrease set in.
 10. The period of the start of the increase of type Ia character (IV.L-V.E/E) was not only the period in which (sub)theme 2 was transferred from wall section 3 to wall section 2 and adopted a type Ia cultic character, but also the period in which (sub)themes 4 and 8 were introduced in significant numbers on the western wall, both of them of type Ia cultic character. This means that it is highly probable that the shift and introductions were intentional and it is probable that further research would reveal that they were part of other, simultaneous, changes.
 11. The type II (a/b) cultic character does not change throughout the Old Kingdom (figure VII.20).

⁴⁰ In table VI.1.Vol.2 the CP/SWS value of the interaction between (sub)themes 2 and 4 and of (sub)themes 4 and 8 is calculated during the period determined by the use life of (sub)themes 2 and 8. The CP/SWS value of the former interaction is 2/4 20/0 and of the latter 4/8 33/0. Indicating a total lack of interaction between the (sub)themes.