



Universiteit  
Leiden  
The Netherlands

## **Pituitary hormone secretion in familial longevity : The Switchbox Study**

Jansen, Wilhelmina Maria

### **Citation**

Jansen, W. M. (2016, February 3). *Pituitary hormone secretion in familial longevity : The Switchbox Study*. Retrieved from <https://hdl.handle.net/1887/37577>

Version: Corrected Publisher's Version

License: [Licence agreement concerning inclusion of doctoral thesis in the Institutional Repository of the University of Leiden](#)

Downloaded from: <https://hdl.handle.net/1887/37577>

**Note:** To cite this publication please use the final published version (if applicable).

Cover Page



Universiteit Leiden



The handle <http://hdl.handle.net/1887/37577> holds various files of this Leiden University dissertation

**Author:** Jansen, Steffy

**Title:** Pituitary hormone secretion in familial longevity : The Switchbox Study

**Issue Date:** 2016-02-03

# Pituitary hormone secretion in familial longevity

THE SWITCHBOX STUDY



Steffy Jansen

**ISBN**

978-94-028-0020-3

**Design/lay-out**

Promotie In Zicht, Arnhem

**Print**

Ipskamp Drukkers, Enschede

© W.M. Jansen, The Netherlands 2016

Copyright of each chapter is with the publisher of the journal in which the work has been published. No part of this thesis may be reproduced, stored in a retrieval system or transmitted in any form or by any means, without permission of the author or, when appropriate, of the publisher of the individual chapters.

The work described in this thesis was supported by the European Commission project Switchbox (FP7, Health-F2-2010-259772).

# PITUITARY HORMONE SECRETION IN FAMILIAL LONGEVITY

## THE SWITCHBOX STUDY

### Proefschrift

ter verkrijging van de graad van Doctor aan de Universiteit Leiden,  
op gezag van Rector Magnificus prof. mr. C.J.J.M. Stolker,  
volgens besluit van het College voor Promoties  
te verdedigen op woensdag 3 februari 2016 klokke 15.00 uur

door

**Wilhelmina Maria Jansen**  
geboren te 's-Hertogenbosch  
in 1986

**Promotoren**

Prof. Dr. R.G.J. Westendorp

Prof. Dr. H. Pijl

**Co-promotor**

Mw. Dr. Ir. D. van Heemst

**Leden promotiecommissie**

Mw. Prof. Dr. J. H. Meijer

Mw. Prof. Dr. B. A. Demeneix (UMR 7221 CNRS / MNHN Evolution des Régulations Endocriniennes, département Régulations, Développement et Diversité Moléculaire, Muséum National d'Histoire Naturelle, Paris, France)

Prof. Dr. E. R. de Kloet (Academic Center of Drug Research, Leiden, The Netherlands)

Voor mijn ouders.





# CONTENTS

<b>Chapter 1</b>	General introduction and outline of the thesis	11
<b>Part I</b>	Switchbox Leiden: study design and data collection	21
<b>Chapter 2</b>	Switchbox Leiden: study design and data collection Jansen SW*, Akintola AA*, Oei NY, Pijl H, Roelfsema F, Westendorp RG, van der Grond J, van Heemst D. on behalf of the Switchbox study	23
<b>Chapter 3</b>	A Simple and Versatile Method for frequent 24 h Blood Sample Collection in Healthy Older Adults Akintola AA*, Jansen SW*, Wilde RBP, Hultzer G, Rodenburg R, van Heemst D. MethodsX. 2015; 2: 33-38. doi:10.1016/j.mex.2014.12.003.	33
<b>Part II</b>	Hypothalamic-pituitary-thyroid axis and longevity	45
<b>Chapter 4</b>	Human Longevity is Characterised by High Thyroid Stimulating Hormone Secretion without Altered Energy Metabolism Jansen SW*, Akintola AA*, Roelfsema F, van der Spoel E, Cobbaert CM, Ballieux BE, Egri P, Kvarata-Papp Z, Gereben B, Fekete C, Slagboom PE, van der Grond J, Demeneix BA, Pijl H, Westendorp RG, van Heemst D. Scientific Reports. 2015; 5. doi: 10.1038/srep11525.	47
<b>Chapter 5</b>	Familial Longevity is Associated with Higher TSH secretion and Strong TSH-fT3 Relationship Jansen SW, Roelfsema F, van der Spoel E, Akintola AA, Postmus I, Ballieux B, Slagboom PE, Cobbaert C, van der Grond J, Westendorp RG, Pijl H, van Heemst D. J Clin Endocrinol Metab. 2015 Oct;100(10):3806-13. doi: 10.1210/jc.2015-2624.	69
<b>Part III</b>	Hypothalamic-pituitary-adrenal axis and longevity	87
<b>Chapter 6</b>	Familial Longevity is Marked by Lower Diurnal Salivary Cortisol Levels: the Leiden Longevity Study Noordam R, Jansen SW*, Akintola AA*, Oei NY, Maier AB, Pijl H, Slagboom PE, Westendorp RG, van der Grond J, de Craen AJ, van Heemst D. PLoS One. 2012;7(2):e31166. doi: 10.1371.	89
<b>Chapter 7</b>	Characterization of the Hypothalamic-Pituitary-Adrenal-Axis in Familial Longevity under Resting Conditions Jansen SW, Roelfsema F, Akintola AA, Oei NY, Cobbaert CM, Ballieux PB, van der Grond J, Westendorp RG, Pijl H, van Heemst D. PLoS One. 2015; 10(7): e0133119. doi: 10.1371	105



<b>Chapter 8</b>	Physiological Responding to Stress in Middle-Aged Males Enriched for Longevity: A Social Stress Study	127
	Jansen SW, van Heemst D, van der Grond J, Westendorp RG, Oei NY. Stress. 2015 Nov 9;1-9. doi:10.3109	
<b>Chapter 9</b>	General discussion	147
	Nederlandse samenvatting	159
	List of publications	171
	Curriculum Vitae	177
	Dankwoord	181



# CHAPTER 1

General introduction  
and outline of the thesis

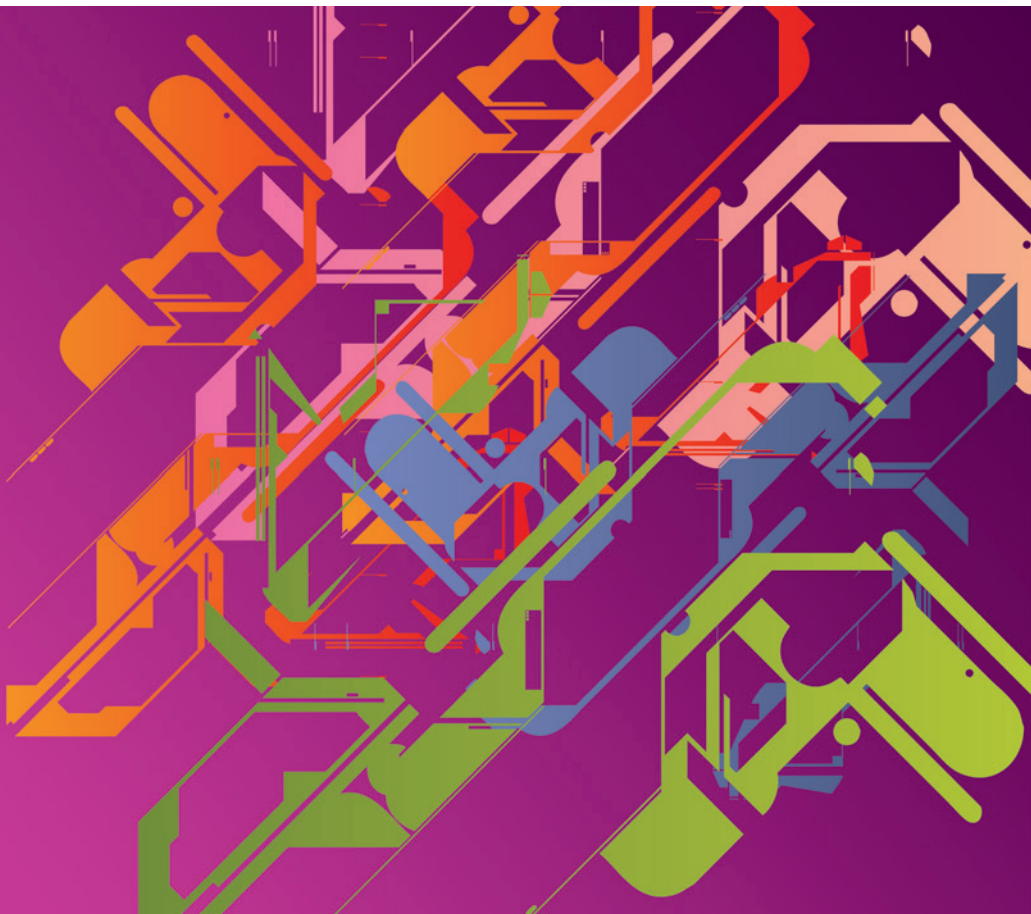



## GENERAL INTRODUCTION

Advances in medicine have reduced infant mortality and cardiovascular deaths at middle age resulting in marked demographic changes. Consequently, worldwide, life expectancy and the proportion of elderly in the population are rising(1). Therefore, it is of critical importance to study genetic and environmental factors and biological mechanisms that allow people to remain healthy and active into their eighties, nineties and above and learn from them how to extend health span.

### Switchbox study

This thesis is part of the European project Switchbox, coordinated by Professor Barbara Demeneix from the Centre National de la Recherche Scientifique Paris, France, where six partners from five different countries hypothesized that health in old age is maintained by better homeostasis. As described in 1865 by the French physiologist Claude Bernard, homeostasis is the ability to dynamically adapt to environmental challenges so that internal conditions remain within certain limits and originates from the Greek words “ὅμοιος” meaning “similar” and “στάσις” meaning “standing still”(2).

### Brain-periphery communication

A good communication between brain and periphery is of critical importance to maintain homeostasis of vital parameters including body temperature, blood pressure, heart rate, and key metabolites, such as glucose. Homeostasis also includes the ability to dynamically adapt vital parameters according to changing internal needs such as those dictated by the sleep-wake rhythm and by changes in the environment, including perceived stress. Two main systems are important for maintenance of homeostasis 1) the nervous system which communicates in electric signals via neurons and 2) hormones which communicate in chemical signals. A master controller of these processes that plays a key role in homeostasis is the hypothalamus (Fig. 1). The hypothalamus receives signals from different brain regions and the periphery and translates these into neuronal and hormonal output signals and thus modulates many different physiological and behavioral processes. The hypothalamus plays an important role in the control of metabolism and of stress responses, two essential systems that are mostly affected during ageing(3). A key regulator of the maintenance of energy homeostasis is the hypothalamic-pituitary-thyroid (HPT)-axis while the stress response is regulated by the hypothalamic-pituitary-adrenal (HPA)-axis (Fig. 1).

Most studies in the field of geriatric medicine focus on diseased subjects or ageing subjects. Only a limited number of studies investigate subjects who have the propensity to reach old age in good health, to disentangle mechanisms that lead to healthy human longevity. Therefore, in this thesis we included offspring from long-lived

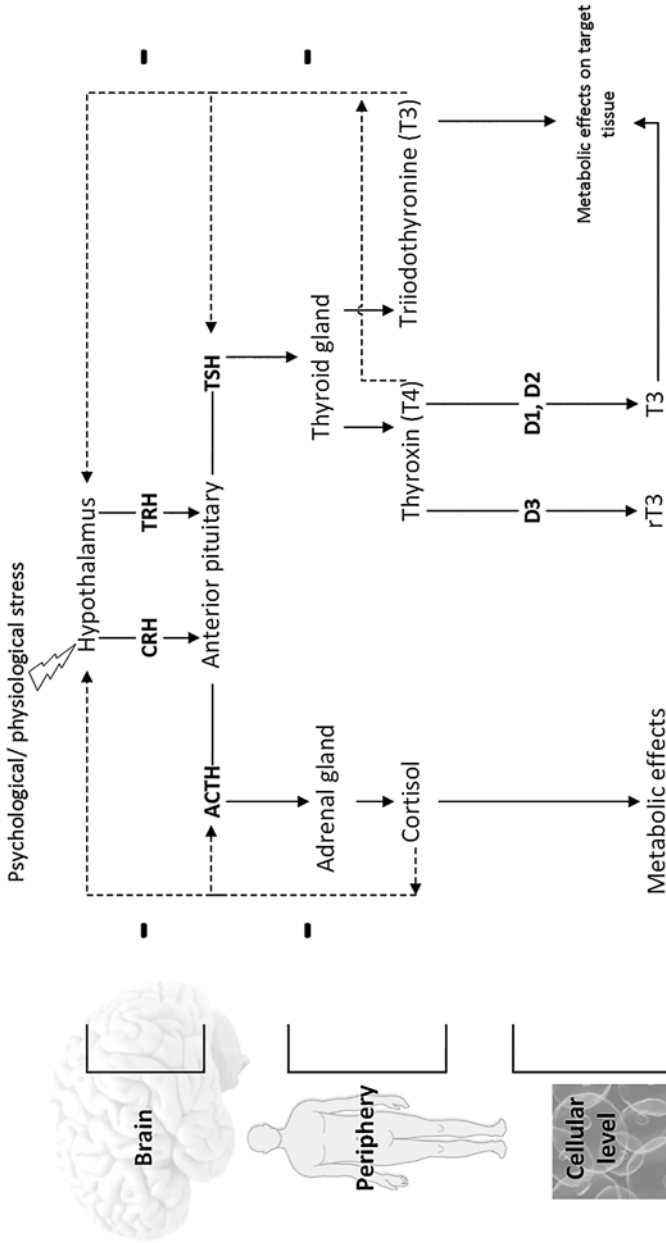

**Figure 1** 'Switchbox' overall hypothesis; the central role of the hypothalamus ('the Switchbox') in endocrine and metabolic homeostasis.

CRH: corticotropin-releasing hormone; TRH: thyrotropin-releasing hormone; ACTH: adrenocorticotropic hormone; TSH: thyroid stimulating hormone; D1,2,3: Deiodinase 1, Deiodinase 2, Deiodinase 3; rT3: reverse T3



siblings, who have the propensity to reach old age in good health together with partners thereof from the Leiden Longevity study (LLS)(4). The focus of this thesis will be on analysis of the HPT-axis and HPA-axis in participants who have the propensity to reach old age in good health compared to age-matched controls. In humans, we are able to assess the 'function' of the HPT- and HPA- axes by measuring the key hormones involved as well as physiological parameters that are affected by these systems (heart rate, metabolism) under different conditions.

### **Hormones and ageing**

The hypothalamic-pituitary-thyroid axis (HPT)-axis is of critical importance during the whole life cycle, and affects key processes, including tissue development, energy metabolism and homeostasis. There is inconsistency in the reporting of changes that occur during ageing in the HPT-axis. Most studies suggest increased levels of thyroid stimulating hormone (TSH)(3, 5-7), while others report no change(8) or lower levels of TSH(9) during ageing. Moreover, with ageing lower levels of fT3, but not fT4 were found(9). In elderly aged 85 years or over, high levels of thyroid stimulating hormone (TSH) have been associated with lower mortality(10), which was confirmed in the subgroup that survived to age ninety(3).

The hypothalamic-pituitary-adrenal (HPA)-axis is an important allostatic system and is of critical importance for survival(11, 12). Various strains of rodents, but not all, were found to exhibit elevated levels of ACTH and/or corticosterone during ageing under resting conditions(13). In humans, aged women tended to have increased morning acrophase under resting conditions(14). A dampened amplitude and an advanced timing of the circadian elevation was found in both men and women during ageing(14). As was found in different strains of aged rodents(13), aged humans may react stronger(15-18) and have a prolonged cortisol response after (psychological) stress(19, 20). This may be associated with impairments in physical and cognitive function, and with adverse metabolic features, such as visceral adiposity, insulin resistance, low high density lipoprotein levels, high blood pressure and increased triglyceride levels(12, 21), all characteristics of an ageing population.

### **Hormones and longevity**

In model organisms and animal models it was found that thyroid hormones (TH) may influence the rate of ageing(3). The maximum lifespan of small mammals such as mice, guinea pigs, Damara mole rats and naked mole rats are negatively correlated with levels of T4(22). Moreover, in different mice strains low T4 signaling in young adults and limited changes of T4 during lifespan were associated with extended life span in male mice(3). Other examples are the Ames dwarf mice, which have a mutation in the Pit-1 gene and the Snell dwarf mice, which have a mutation in the Prop-1 gene, both of which affect the development of the anterior pituitary. These

mice have a reduced activity of the somatotrophic-, lactotrophic- and thyroid-axes due to a combined lack of growth hormone (GH), thyroid stimulating hormone (TSH) and prolactin (PRL). Although these animals are small and have a reduced fertility, under laboratory condition these mice have an increased life span of at least 40% up to 70% compared to wild type mice(23). These endocrine deficits have also effects on their metabolism, resulting in lower core body temperature(24) and higher basal metabolic rate at standard animal room temperature due to the increased energy demands for thermoregulation(25). When Snell dwarf mice were treated for a long time with thyroxine (T4), which is also reduced in these animals, it reduces their life span, meaning that lifelong low thyroid hormone levels may contribute to the longevity phenotype in at least dwarf mice(26).

Also in humans, associations have been observed between thyroid hormone regulation and longevity. Families with the lowest mortality history score, displaying the lowest mortality, had the highest levels of TSH and lowest levels of free thyroxin (fT4) and free triiodothyronine (fT3)(27). In another cohort study, Ashkenazi Jewish centenarians also displayed higher TSH levels as did their offspring when compared to matched controls(28).

The HPA-axis is a critical component of the body's response to stressful conditions, including both physiological and psychological stressors. The many day to day responses to chronic and acute stress, including the 'fight or flight' reaction, result in cumulative load on the body's stress responsive physiological systems, such as the cardiovascular and glucose regulatory systems (allostatic load) which can have severe long term health consequences(12). Changes in HPA-axis are associated with different adverse conditions, including hypertension, impaired cognitive function and adverse metabolic features. In rats, genetic differences in HPA-axis activity and reactivity have been associated with differences in lifespan. Brown Norway rats which display distinct differences in HPA-axis activity and reactivity, including faster recovery after restraint stress, have extended lifespan(29), while Wistar Kyoto rats are characterized by shorter lifespan and hyper-reactivity to stressors(30). No human data was available on HPA-axis reactivity under resting conditions or stress conditions in relation with longevity.

The aim of this thesis was threefold. In the first part, we describe the Switchbox Leiden design and data collection, and method used for 24 hour blood sampling. In the second part, we characterized the HPT-axis, and in the third part the HPA-axis, in relation with familial longevity.

## OUTLINE OF THE THESIS

In **Part I: Switchbox Leiden: study design and data collection**, **chapter two** is an overview of the Switchbox study and the data collection procedure. In **chapter three** we customize 24 h blood sampling protocols for the application in aged study participants.

In **Part II: Hypothalamic-pituitary-thyroid axis and longevity**, we use in **chapter four** frequent blood sampling over 24 hours to study TSH secretion and TH levels. We investigate whether differences in TSH and/or TH concur with differences in energy metabolism. In **chapter five** we characterize the HPT-axis in more detail and investigate if changes in ultradian rhythmicity of TSH could be an underlying mechanism of the changes in HPT-axis function. Moreover, we investigate if changes in circadian rhythmicity of TSH contribute to the longevity phenotype.

In **Part III: Hypothalamic-pituitary-adrenal axis and longevity**, we collect in 330 offspring and partners from the LLS, saliva samples in a home based setting to study in **chapter six** if saliva cortisol levels in the morning and evening were different between offspring and partners. In **chapter seven** we investigate in 38 offspring and partners of the LLS the HPA-axis in more detail by analysis of the HPA-axis dynamics over a 24-hour period. And in **chapter eight** we challenge the HPA-axis to investigate if offspring compared to partners have a different physiological response to psychological stress.

In **chapter nine** we place our findings in perspective and discuss the importance of challenge experiments in physiological research and give indications for future research.

## REFERENCES

1. **Abbott A.** Ageing: growing old gracefully. *Nature*. 2004;428(6979):116-8.
2. **Cannon WB.** Physiological regulation of normal states: some tentative postulates concerning biological homeostatics". In A. Pettit(ed.). *A Charles Richet : ses amis, ses collègues, ses élèves* (in French). Paris: *Les Éditions Médicales*. 1926:p91.
3. **Bowers J, Terrien J, Clerget-Froidevaux MS, Gothie JD, Rozing MP, Westendorp RG, van Heemst D, and Demeneix BA.** Thyroid hormone signaling and homeostasis during aging. *Endocr Rev*. 2013;34(4):556-89.
4. **Westendorp RG, van Heemst D, Rozing MP, Frolich M, Mooijaart SP, Blauw GJ, Beekman M, Heijmans BT, de Craen AJ, Slagboom PE, and Leiden Longevity Study G.** Nonagenarian siblings and their offspring display lower risk of mortality and morbidity than sporadic nonagenarians: The Leiden Longevity Study. *J Am Geriatr Soc*. 2009;57(9):1634-7.
5. **Tunbridge WM, Evered DC, Hall R, Appleton D, Brewis M, Clark F, Evans JG, Young E, Bird T, and Smith PA.** The spectrum of thyroid disease in a community: the Whickham survey. *Clin Endocrinol (Oxf)*. 1977;7(6):481-93.
6. **Sawin CT, Chopra D, Azizi F, Mannix JE, and Bacharach P.** The aging thyroid. Increased prevalence of elevated serum thyrotropin levels in the elderly. *JAMA*. 1979;242(3):247-50.
7. **Hollowell JG, Staehling NW, Flanders WD, Hannon WH, Gunter EW, Spencer CA, and Braverman LE.** Serum TSH, T(4), and thyroid antibodies in the United States population (1988 to 1994): National Health and Nutrition Examination Survey (NHANES III). *J Clin Endocrinol Metab*. 2002;87(2):489-99.
8. **Barreca T, Franceschini R, Messina V, Bottaro L, and Rolandi E.** 24-hour thyroid-stimulating hormone secretory pattern in elderly men. *Gerontology*. 1985;31(2):119-23.
9. **van Coevorden A, Laurent E, Decoster C, Kerkhofs M, Neve P, van Cauter E, and Mockel J.** Decreased basal and stimulated thyrotropin secretion in healthy elderly men. *J Clin Endocrinol Metab*. 1989;69(1):177-85.
10. **Gussekloo J, van Exel E, de Craen AJ, Meinders AE, Frolich M, and Westendorp RG.** Thyroid status, disability and cognitive function, and survival in old age. *JAMA*. 2004;292(21):2591-9.
11. **Sapolsky RM, Krey LC, and McEwen BS.** The neuroendocrinology of stress and aging: the glucocorticoid cascade hypothesis. *Endocr Rev*. 1986;7(3):284-301.
12. **McEwen BS.** Protective and damaging effects of stress mediators. *N Engl J Med*. 1998;338(3):171-9.
13. **de Kloet ER.** Corticosteroids, stress, and aging. *Ann N Y Acad Sci*. 1992;663(357-71).
14. **Van Cauter E, Leproult R, and Kupfer DJ.** Effects of gender and age on the levels and circadian rhythmicity of plasma cortisol. *J Clin Endocrinol Metab*. 1996;81(7):2468-73.
15. **Otte C, Hart S, Neylan TC, Marmar CR, Yaffe K, and Mohr DC.** A meta-analysis of cortisol response to challenge in human aging: importance of gender. *Psychoneuroendocrinology*. 2005;30(1):80-91.
16. **Almela M, Hidalgo V, Villada C, van der Meij L, Espin L, Gomez-Amor J, and Salvador A.** Salivary alpha-amylase response to acute psychosocial stress: the impact of age. *Biol Psychol*. 2011;87(3):421-9.
17. **Kudielka BM, Buske-Kirschbaum A, Hellhammer DH, and Kirschbaum C.** HPA axis responses to laboratory psychosocial stress in healthy elderly adults, younger adults, and children: impact of age and gender. *Psychoneuroendocrinology*. 2004;29(1):83-98.
18. **Strahler J, Mueller A, Rosenloecher F, Kirschbaum C, and Rohleder N.** Salivary alpha-amylase stress reactivity across different age groups. *Psychophysiology*. 2010;47(3):587-95.
19. **Aguilera G.** HPA axis responsiveness to stress: implications for healthy aging. *Exp Gerontol*. 2011;46(2-3):90-5.
20. **Sapolsky RM, Krey LC, and McEwen BS.** The adrenocortical stress-response in the aged male rat: impairment of recovery from stress. *Exp Gerontol*. 1983;18(1):55-64.
21. **Seeman TE, Singer BH, Rowe JW, Horwitz RI, and McEwen BS.** Price of adaptation--allostatic load and its health consequences. MacArthur studies of successful aging. *Arch Intern Med*. 1997;157(19):2259-68.
22. **Buffenstein R, and Pinto M.** Endocrine function in naturally long-living small mammals. *Mol Cell Endocrinol*. 2009;299(1):101-11.

23. **Brown-Borg HM, Borg KE, Meliska CJ, and Bartke A.** Dwarf mice and the ageing process. *Nature*. 1996;384(6604):33.
24. **Hunter WS, Croson WB, Bartke A, Gentry MV, and Meliska CJ.** Low body temperature in long-lived Ames dwarf mice at rest and during stress. *Physiol Behav*. 1999;67(3):433-7.
25. **Bartke A, and Westbrook R.** Metabolic characteristics of long-lived mice. *Front Genet*. 2012;3(288).
26. **Vergara M, Smith-Wheelock M, Harper JM, Sigler R, and Miller RA.** Hormone-treated snell dwarf mice regain fertility but remain long lived and disease resistant. *J Gerontol A Biol Sci Med Sci*. 2004;59(12):1244-50.
27. **Roizing MP, Houwing-Duistermaat JJ, Slagboom PE, Beekman M, Frolich M, de Craen AJ, Westendorp RG, and van Heemst D.** Familial longevity is associated with decreased thyroid function. *J Clin Endocrinol Metab*. 2010;95(11):4979-84.
28. **Atzmon G, Barzilai N, Surks MI, and Gabriely I.** Genetic predisposition to elevated serum thyrotropin is associated with exceptional longevity. *J Clin Endocrinol Metab*. 2009;94(12):4768-75.
29. **Mos J, and Hollander CF.** Analysis of survival data on aging rat cohorts: pitfalls and some practical considerations. *Mech Ageing Dev*. 1987;38(1):89-105.
30. **Tizabi Y, Aguilera G, and Gilad GM.** Age-related reduction in pituitary corticotropin-releasing hormone receptors in two rat strains. *Neurobiol Aging*. 1992;13(2):227-30.



# PART I

## Switchbox Leiden: study design and data collection







# CHAPTER 2

## Switchbox Leiden: study design and data collection

Jansen SW\*, Akintola AA\*, Oei NY, Pijl H, Roelfsema F, Westendorp RG, van der Grond J, van Heemst D. on behalf of the Switchbox study

\*equal contributions of both authors





## STUDY POPULATION AND RECRUITMENT STRATEGY

To study endocrine and metabolic regulation in relation with health in old age, participants were recruited from the Leiden Longevity Study (LLS)(1). The LLS was designed to study genotypes and phenotypes which could explain inter-individual differences in familial human longevity(2).

Between January 2012 and April 2013, 494 offspring from long-lived siblings and partners from the LLS were asked via an invitation letter to participate in the Switchbox study (Fig. 1). These participants were selected based on previous obtained information(1), and were middle-aged (55-77 yr) and had a body mass index (BMI) between 19 and 33 kg/m<sup>2</sup>. Of the 494 participants, 218 participants were willing to participate in the Switchbox study. After a medical screening by phone for all participants who agreed to participate, and an additional home visit for the participants willing to participate in the more intensive study program (group A), 135 participants were found eligible to participate according to the exclusion criteria listed in Table 1.

**Table 1** In- and exclusion criteria for Switchbox participants

Exclusion criteria Switchbox participants	
Laboratory results	Fasting Plasma glucose > 7 mmol/L Hemoglobin < 7.1 mmol/L TSH < 0.3 mU/L or > 4.8 mU/L fT4 < 10 pmol/L or > 24 pmol/L
Disease history	Any significant chronic disease; renal, hepatic or endocrine disease
Medication use	Hormone therapies Use of medication known to influence lipolysis
Lifestyle	Recent weight changes (> 3 kg weight gain/loss within last 3 months) Extreme diet therapy Alcohol consumption of more than 28 units/week Smoking addiction
Others	Severe claustrophobia Difficulties to insert IV cannula Blood donation (< 2 months) Participation in other research project (< 3 months or >2 within 1 year)

### Data collection of the Switchbox Study

Between March 2012 and July 2013 all participants underwent the study protocol, after an overnight fast at the study center of the Leiden University Medical Center as described in Fig. 2. A short description of the different study parts is presented below.

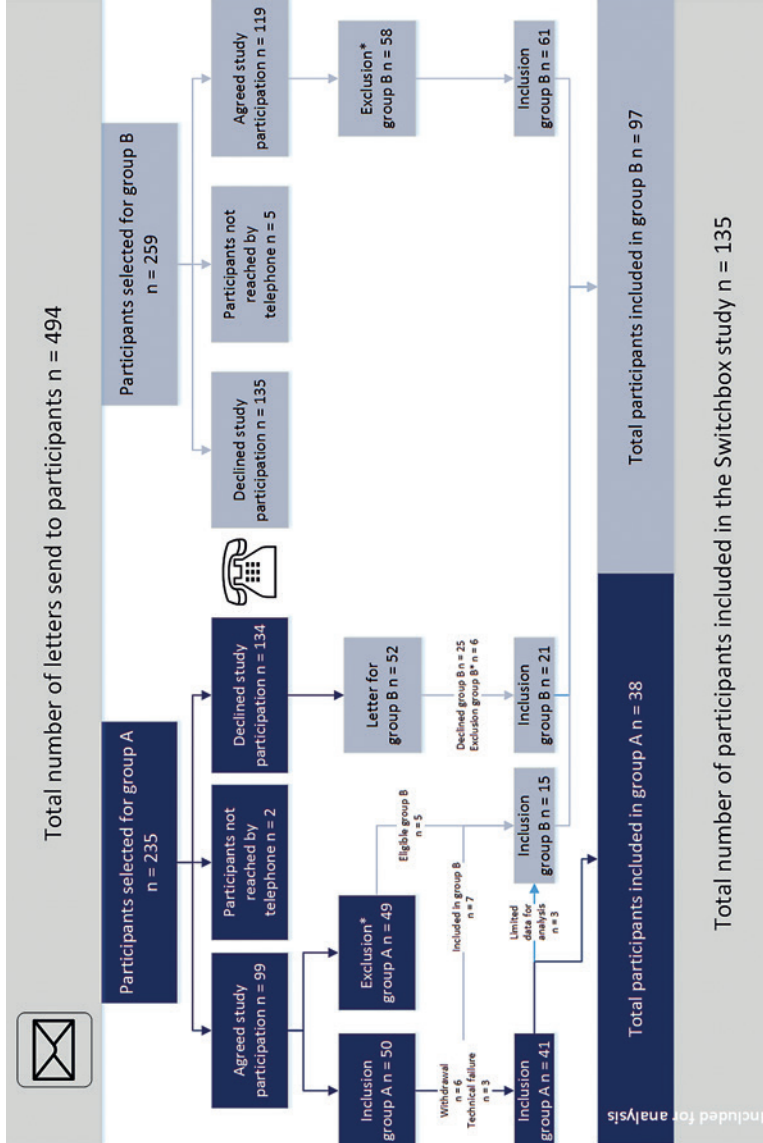

**Figure 1** Recruitment flowchart of Switchbox participants.

Study details on Group A and B are depicted in Fig. 2. \*Participants were not eligible for the study according to the in- and exclusion criteria listed in table 1

*Trier social stress test:* Study participants were randomized such that half of them received a stress condition according to the Trier social stress test (TSST)(3) and the other half a placebo non-stress condition. The TSST is a widely used laboratory protocol that reliably stimulates biomarkers of stress in all age ranges(4).

*fMRI:* Several tests were selected during functional imaging to assess emotional working memory, emotion regulation and behavior, in half of the participants under stress condition and the other half in resting/non-stressed condition.

*Questionnaires:* Different questionnaires, including the MINI(5) and geriatric depression scale(6), were used for screening of psychiatric diseases including depression. Moreover, validated questionnaires for the assessment of e.g. neuroticism, anxiety traits (STAI)(7), mood and personality(8) were completed. Also neurocognitive tests, including the controlled word association test (COWAT)(9) for verbal fluency and digit span to assess working memory's number storage capacity, were performed. Two questionnaires were completed to assess the quality of sleep (Pittsburg Sleep Quality Index(10)) and the chronotype (Munich sleep questionnaire(11)).*Blood samples:* Fasted whole blood samples were taken between 12.00h and 13.00h, plasma and serum samples were used for measurements of hormones and additional serum aliquots were stored at -80°C for future studies.

*Body composition measurements:* Body composition, including fat mass and lean mass were measured using a Bioelectrical Impedance Analysis meter at a fixed frequency of 50kHz (Bodystat® 1500 Ltd, Isle of Man, British Isles)(12).

*Indirect calorimetry:* Participants had two times a 30 minutes indirect calorimetry session using a ventilated hood system (Care Fusion Canopy Jaeger Oxycon Pro, Houten, The Netherlands) after 14 hours of fasting and after a standardized meal (nutridrink, Nutricia, Zoetermeer, The Netherlands). Participants were kept under standardized conditions, lying awake and emotionally undisturbed. Inspired oxygen (VO<sub>2</sub>) and expired carbon dioxide were measured (VCO<sub>2</sub>) and amongst other resting metabolic rate were calculated using standard formulas(13).

*Continuous physiological measurements:* For continuous measurements over a 5 day period of electrocardiography, core body temperature, breathing rate and physical activity an Equivital monitor (Equivital EQ02 SEM, Hidalgo, UK) was used. In order to assess core body temperature, each participant swallowed one Core Body Temperature Capsule (Capsule REF 500-0100-02, Respirationics Inc., Murrysville, PA, USA) at each of three consecutive days (Fig. 2). Additionally, participants were asked to wear activity watches on their wrist and ankle (GENEActive, Kimbolton, UK) for

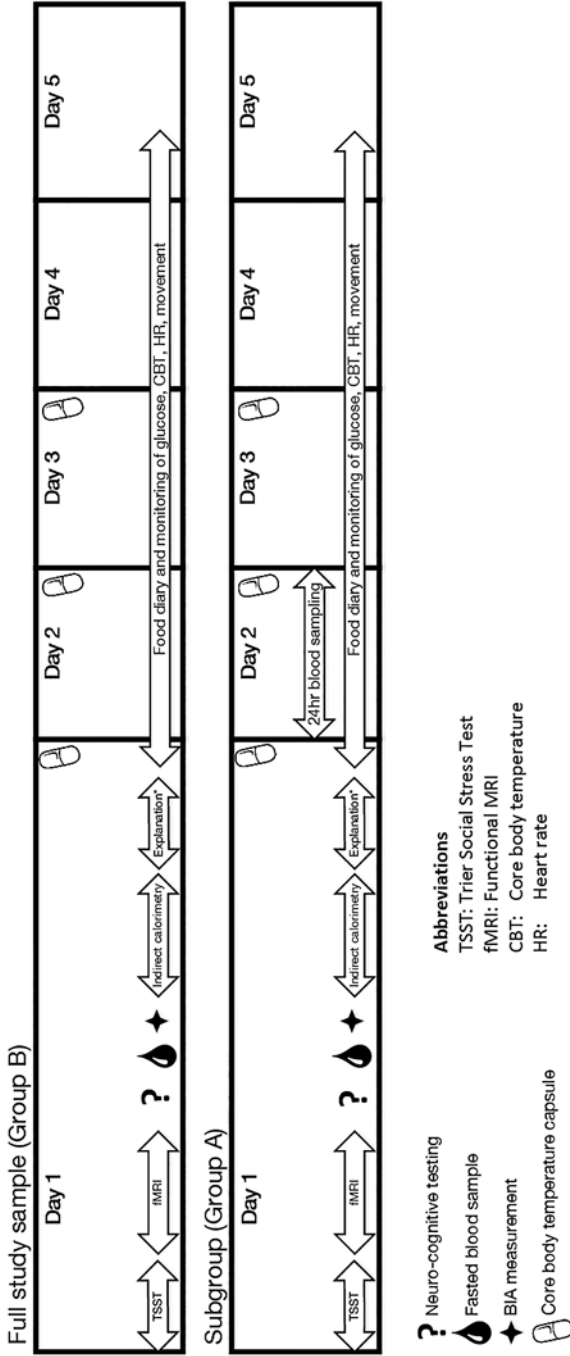

**Figure 2** Recruitment flowchart of Switchbox participants.

Study details on Group A and B are depicted in Fig. 2. \*Participants were not eligible for the study according to the in- and exclusion criteria listed in table 1

more detailed measurements of physical activity. For continuous measurements of glucose over the 5 day period, a continuous glucose monitor was applied (Medtronic MiniMed Inc., Northridge, CA, USA).

*Diaries:* During the study period, participants were asked to fill out details on food intake, charging times of the monitors, capillary blood glucose, physical activity and sleeping times.

*24-hour blood sampling:* Of the 135 participants, 38 participants had a complete series of 24-hour blood samples. Details on the procedure for 24 hour blood sampling can be found in the next chapter.

## REFERENCES

1. Westendorp RG, van Heemst D, Rozing MP, Frolich M, Mooijaart SP, Blauw GJ, Beekman M, Heijmans BT, de Craen AJ, Slagboom PE, and Leiden Longevity Study G. Nonagenarian siblings and their offspring display lower risk of mortality and morbidity than sporadic nonagenarians: The Leiden Longevity Study. *J Am Geriatr Soc.* 2009;57(9):1634-7.
2. Schoenmaker M, de Craen AJ, de Meijer PH, Beekman M, Blauw GJ, Slagboom PE, and Westendorp RG. Evidence of genetic enrichment for exceptional survival using a family approach: the Leiden Longevity Study. *Eur J Hum Genet.* 2006;14(1):79-84.
3. Kirschbaum C, Pirke KM, and Hellhammer DH. The 'Trier Social Stress Test'--a tool for investigating psychobiological stress responses in a laboratory setting. *Neuropsychobiology.* 1993;28(1-2):76-81.
4. Kudielka BM, Buske-Kirschbaum A, Hellhammer DH, and Kirschbaum C. HPA axis responses to laboratory psychosocial stress in healthy elderly adults, younger adults, and children: impact of age and gender. *Psychoneuroendocrinology.* 2004;29(1):83-98.
5. Sheehan DV, Lecrubier Y, Sheehan KH, Amorim P, Janavs J, Weiller E, Hergueta T, Baker R, and Dunbar GC. The Mini-International Neuropsychiatric Interview (M.I.N.I.): the development and validation of a structured diagnostic psychiatric interview for DSM-IV and ICD-10. *J Clin Psychiatry.* 1998;59 Suppl 20(22-33;quiz 4-57).
6. Yesavage JA, Brink TL, Rose TL, Lum O, Huang V, Adey M, and Leirer VO. Development and validation of a geriatric depression screening scale: a preliminary report. *J Psychiatr Res.* 1982;17(1):37-49.
7. Spielberger CD. *Manual for the State-Trait Anxiety Inventory (STA)*. . Palo Alto, CA: Consulting Psychologists; 1983.
8. W. A. Arrindell JHME. *SCL-90. Handleiding bij Multidimensionele Psychopahtologie-Indicator*.: Swets & Zeitlinger B.V. Lisse; 1986.
9. Lezak MD. *Neuropsychological Assessment*. Oxford University Press; 1995.
10. Buysse DJ, Reynolds CF, 3rd, Monk TH, Berman SR, and Kupfer DJ. The Pittsburgh Sleep Quality Index: a new instrument for psychiatric practice and research. *Psychiatry Res.* 1989;28(2):193-213.
11. Roenneberg T, Wirz-Justice A, and Merrow M. Life between clocks: daily temporal patterns of human chronotypes. *J Biol Rhythms.* 2003;18(1):80-90.
12. Kyle UG, Bosaeus I, De Lorenzo AD, Deurenberg P, Elia M, Gomez JM, Heitmann BL, Kent-Smith L, Melchior JC, Pirlich M, Scharfetter H, Schols AM, Pichard C, and Composition of the EWG. Bioelectrical impedance analysis--part I: review of principles and methods. *Clin Nutr.* 2004;23(5):1226-43.
13. Simonson DC, and DeFronzo RA. Indirect calorimetry: methodological and interpretative problems. *Am J Physiol.* 1990;258(3 Pt 1):E399-412.







# CHAPTER 3

## A simple and versatile method for frequent 24 h blood sample collection in healthy older adults

Akintola AA\*, Jansen SW\*, Wilde RBP, Hultzer G, Rodenburg R, van Heemst D.  
*MethodsX*. 2015; 2: 33-38. doi:10.1016/j.mex.2014.12.003.

\*equal contributions by both authors



## ABSTRACT

Repeated 24 h blood sampling, which is required for time series analyses of metabolites and/or hormones that show strong fluctuations in blood concentration over time, has a higher failure rate in older adults. We tailored existing venepuncture protocols towards use for 24 h blood sampling (sampling frequency of 10 minutes) in older adults. The following modifications were made:

- Pre-sampling: evidence based risk assessment of older adults
- During sampling:
  - o Ultrasound- guided identification and characterisation of veins.
  - o Use of 20-gauge arterial catheter with guide wire for venous access.
  - o Measures to prevent and/or reduce unidirectional blood flow (fluid flow into but not out of the vein) included:
    - Use of hot water bottles to dilate veins.
    - Use of small gauge syringes, shortening of the extension line, and slowing of the blood withdrawal rate to reduce pressure on veins.
    - Stimulation of movement of the arm or retraction of the IV cannula to relieve mechanical flow obstruction.
- Post-sampling: prevention of bruising and prolonged bleeding.

<u>Standard protocols</u>	<u>Problems in older adults</u>	<u>Adaptations to existing protocols</u>
<i>Pre-sampling</i>	<i>Pre-sampling</i>	<i>Pre-sampling</i>
Screening participants	Guidelines based on 18-65 years	Risk assessment older adults
Maximal amount blood	Guidelines based on 18-65 years	Based on sex and weight
<i>During sampling</i>	<i>During sampling</i>	<i>During sampling</i>
Venous identification & access	Unstable, tortuous veins	<ul style="list-style-type: none"> <li>• Identification via ultrasound guidance</li> <li>• Cannulation with guide wire catheter</li> <li>• Relaxed environment</li> </ul>
Frequent blood withdrawal	Validated guidelines not available	<ul style="list-style-type: none"> <li>• Dilatation of veins: hot water bottles</li> <li>• Reduction of pressure on veins: small gauge syringes, shorter extension lines, slow withdrawal of samples</li> </ul>
Maintenance of IV access	Higher failure rate Uni-directional flow	<ul style="list-style-type: none"> <li>• Minimization of mechanical obstruction of vessel lumen: stimulation arm movements, retraction of IV cannula</li> </ul>
<i>Post-sampling</i>	<i>Post-sampling</i>	<i>Post-sampling</i>
Use of heparinized saline to flush the extension line	Heparinized saline for flushing fluid may cause prolonged clotting times	Saline without heparin for flushing extension lines
Sample processing	Re-clotting of pre- centrifuged samples	Removal of clot and re-centrifugation
Removal of IV cannula	Bruising and prolonged bleeding	Gentle pressure >3 minutes, use of pressure bandage

## METHOD DETAILS

Repeated 24 h blood sampling, a frequently used method in research, is required for time series analyses of metabolites and/or hormones that show strong fluctuations in blood concentration over time. Repeated 24 h blood sampling has a higher failure rate in older adults due to difficulty in establishing and maintaining venous access due to age- induced changes in the integrity of the skin, venous vasculature and valves. Therefore we customized pre-sampling, sampling and post-sampling procedures for continuous sampling in older adults. In our research center, the customized protocol was used for 24 h blood sampling with a sample frequency of 10 min in a group of 41 elderly mean (range) age of 66 (52-76) years. With the customized protocol, the mean (standard deviation) number of missing samples was 6.3 (7.0) out of 144 (4.4%). Thus, the customized protocol that is discussed in more detail below represents a useful and successful method for high frequency sampling of blood in healthy older adults.

### A. PRE-SAMPLING

#### 1. Screening of participants

Maintenance of IV access and blood withdrawal proved to be most problematic in subjects older than 75 years of age, since venous capacitance and compliance reduces with age(1).

#### Standard protocols

According to the European guidelines(2), the age range for blood donation is 18-65 years. Above the age of 65 years, blood donation is allowed only at the discretion of the responsible physician(2). This medical discretion can be applied on an individual basis or through a systematic approach based on an appropriate risk assessment.

#### Adaptations made

A systematic risk assessment (Table 1) by a suitably qualified individual (physician) was done before inclusion of older subjects ( $\geq 65$  years) for repeated 24h blood sampling.

Risks assessed:

Medical status: was assessed through medical history, medication use, physical examination and laboratory investigations. We assessed for:

- General state of health, presence of medical conditions and use of medications
  - Acceptable systolic blood pressure was  $\leq 180$  mmHg and diastolic blood pressure  $\leq 100$  mmHg(2)
  - Acceptable pulse of 50-100 (regular) beats per minute(2)

- Acceptable BMI of 18-30 kg/m<sup>2</sup>
- Absence of anemia
- Assessment to exclude conditions that may interfere with maintenance of venous access such as:
  - Extensive scarring on one or both hands
  - Previous mastectomy
  - Previous fistula or vascular graft
  - Severe arteriosclerosis
  - Previous history of chemotherapy use

## **2. Determination of maximal amount of blood per sampling**

There is presently no consensus as to the maximum amount of blood that can be withdrawn in older adults since blood donation guidelines are based on adults aged 18- 65 years.

### **Standard protocols**

Based on the European guideline(2) the maximum amount of blood that can be withdrawn is dependent on the weight and sex of the person, to a maximum of 500 ml over a 24 h period. No more than 15% of the estimated blood volume is to be collected as whole blood, because of the risk of adverse reactions(2).

### **Adaptations made**

We calculated maximum blood volume that can be withdrawn based on the weight, height, age and gender using a validated formula developed by the International Council of Standardisation in Haematology (ICHS)(3).

## **B. DURING SAMPLING**

### **3. Venous cannulation: Identification**

In older adults, skin loses tone and elasticity and becomes more fragile and prone to bruising. Upon finding a suitable blood withdrawal site, loss of subcutaneous tissue in older adults result in their veins being less stable, less visible, prone to receding and rolling under the skin thus reducing available IV access sites.

### **Standard protocols**

Standard venepuncture and phlebotomy guidelines involve visual identification of forearm veins (median cubital and median veins) followed by venepuncture(4, 5).

**Table 1** Schematic overview of systematic assessment of older adults, to determine eligibility for frequent blood sampling.

<b>Standard screening:</b>	<b>Pay attention to:</b>	<b>Reason for attention:</b>
Medical history	<ul style="list-style-type: none"> <li>Previous contra- indications to blood donation</li> <li>Previous difficulty with venipuncture</li> <li>Previous mastectomy/ relevant surgery</li> <li>Previous fistula or vascular graft</li> <li>Severe arteriosclerosis</li> <li>History of chemotherapy</li> </ul>	<ul style="list-style-type: none"> <li>Contra-indications of placement of IV cannula</li> <li>Frail veins, stiffened valves</li> </ul>
Medication use	<ul style="list-style-type: none"> <li>Anti-coagulants</li> <li>Medications relevant to hormone(s) of interest</li> </ul>	<ul style="list-style-type: none"> <li>Increased bleeding risk causing bruises</li> </ul>
Review of systems	<ul style="list-style-type: none"> <li>Palpitations</li> <li>Chest pain</li> <li>Signs of TIA (neurological paralysis)</li> </ul>	<ul style="list-style-type: none"> <li>These symptoms are indicators of underlying cardiac and brain hypo-perfusion, withdrawal of high amounts of blood may lead to damage to those tissue due to decreased oxygenation</li> </ul>
Medical examination	<ul style="list-style-type: none"> <li>Appearance of blood vessels</li> <li>Extensive scaring on one or both hands</li> <li>Pulse</li> <li>Blood pressure</li> <li>Cardiac sounds</li> </ul>	<ul style="list-style-type: none"> <li>Problems with insertion of IV cannula</li> <li>To detect unknown cardiac problems</li> </ul>

### Adaptations made

Ultrasonography (US) was used for peripheral vein cannulation in subjects with difficult venous access to identify the peripheral vessels and guide the cannulation of the peripheral vein (6, 7). US guidance was used for:

- Easier localisation of the vessel and its relation to surrounding anatomical structures
- Determination of vascular quality and tortuosity of the veins
- Presence and location of intravascular valves

### 4. Venous cannulation: Access

In older adults more time is needed to find the most appropriate access site, since veins are more difficult to find, more tortuous and veins have a tendency to collapse more due to degeneration of the vascular wall(8).

### Standard protocols

Inspection of the antecubital fossa in preparation for cannulation, skin preparation with 2% chlorhexidine and insertion of appropriate cannula. Pressure is applied in cases of failed cannulation.

### Adaptations made

In addition to the standard protocol, the following adaptations were implemented to improve success in older adults:

- i. US- guided identification of the cephalic vein, basilica vein and median cubital vein.
- ii. Cannulation with a 20-gauge guide wire catheter, 8 cm in length, inserted with Seldinger technique (Arrow International, Reading, PA, USA).
  - ! The choice to use arterial catheters is supported by literature reporting that the use of standard-length (3-5cm) catheters positioned in the deep brachial or basilica vein is frequently complicated by their dislodgment or dislocation(7). Furthermore, the use of a longer IV-catheter provides freer arm movement and will increase comfort in individual subjects. Moreover, the amount of catheter failure and dislocation compared to standard-length IV catheters in the deep brachial and basilica vein is lower(6, 7). Keyes et al.(6) observed that the failure rate of peripherally inserted catheters was 8% within the first hour after venous cannulation. In a recent study, Elia et al. reported percentages of catheter failure of 45% vs 14%, [RR 3.2 (95% CI 1.4-7.3)], and dislocation of 42.5% vs 2.3% [RR 18.7 (95% CI 2.0-134.2)] when comparing standard-length to long IV catheters, inserted in the deep brachial and basilica vein(7).
  - ! Nicking the skin with a scalpel or the use of a dilatator is not necessary.
  - Venepuncture and catheter introduction is an aseptic procedure necessitating the use of sterile gloves. Finger guidance of the shaft of the exposed needle is not required.



- iii. In subjects with prominent veins, the basilica vein was the preferred access route because the basilica vein has a larger diameter compared with the cephalic vein, is easier to access and more suited for frequent blood sampling(9). We cannulated with Arrow Catheterization Set (Product No. SAC 00820) without complications.

## 5. Frequent blood withdrawal

### Standard protocols

No published validated protocol was found for older adults. A previous study recommended addition of heparin 100 IU/mL continuous saline infusion to prevent the IV system from clots and to reduce the number of catheter-related phlebitis/occlusions(10).

### Adaptations made

For detailed hormonal and metabolic profiling of older adults aged 55-78 years, we aimed at total blood withdrawal of 432 ml over a 24 h period. Serum (2 ml) and plasma (1.2 ml) samples were withdrawn every 10 min, with replacement by 480 ml of heparinized saline, using the following protocol (Figure 1):

- i. Continuous infusion of heparinized saline (0.9% NaCl).
- ii. For the preparation of the heparinized saline, 500 IU of heparin was added to 500 ml of saline. This was infused over 24 h via an infusion pump at a rate of 20 ml per h.
- iii. Withdrawal of 5 ml of saline/heparin mixed with blood, without disconnecting the syringe from the blood withdrawal system.
- iv. Placement of the 1.2 ml ethylenediaminetetraacetic acid (EDTA) Sarstedt S-monovette® (Nümbrecht, Germany) on the multiadaptor for S-monovette® (Nümbrecht, Germany) for blood sample withdrawal after which the blood was mixed gently with the EDTA and placed immediately on ice.
- v. Placement of the 2 ml blood collection clotting tube BD (Franklin Lakes, USA ) on the BD vacutainer®, (Franklin Lakes, USA ). The sample was withdrawn and mixed with the clotting activator by gently turning the tube five times, after which it was allowed to clot for at least 30 minutes at room temperature.
- vi. Flushing of the blood from the 5 ml syringe back into the subject, to reduce the total amount of blood that will be withdrawn.
- vii. Flushing of the blood withdrawal system (including the extension line) to remove diluted blood, using 5 ml saline (0.9% NaCl).

## 6. Maintenance of IV access

In older adults, blood sampling was sometimes jeopardised by unidirectional blood flow (free flow of fluid into the vein but not out of the vein), with resultant impedance of sustained blood withdrawal. This is possibly due to reduced tone of the vessel wall, age- induced fibrosis of the wall of the veins and valve leaflets.

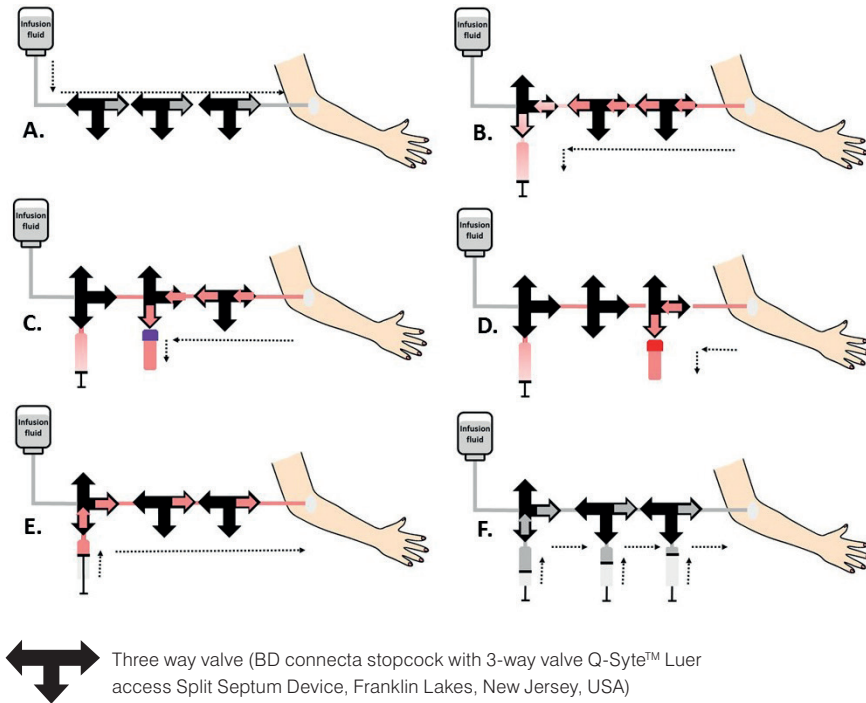

**Figure 1** Schematic overview of a closed method for frequent 24 hour blood sample collection.

A. Continuous infusion B. Turn the left three way valve 90°, withdraw 5 ml of saline/heparin mixed with blood C. Turn the middle three way valve 90°, withdraw EDTA sample and place it directly on ice D. Turn the right three way valve 90°, withdraw serum sample and let it clot for at least 30 minutes E. Turn the right and middle three way valve 90° and empty the syringe filled with the saline/heparin mixed with blood F. Flush with saline and turn the left three way valve 90° and continue with infusion (return to position A.).

**Standard protocols**

No validated guidelines were available for older subjects.

**Adaptations made**

- Creation of a relaxing environment to reduce stress for the participant
- The participants were allowed to move their arm freely
- Application of hot water bottles to increase the diameter of the vessel
- Use of small gauge syringes (e.g. 2 ml syringes instead of 5 ml syringes) to reduce pressure on the vessel wall

- Obtaining blood samples very slowly e.g. using 1 ml/ 2 ml syringes
- Retraction of the IV catheter a few millimeters to change its position

## C. POST SAMPLING

### 7. Processing of samples

Variable, sometimes prolonged clotting times in older adults

#### Standard protocols

There are different protocols depending on the hormone to be measured.

#### Adaptations made

For serum samples, blood was allowed to clot. Clotting time was very variable for older adults, ranging from approximately 15- 70 minutes. Preferably within 60 min of sampling, tubes were centrifuged at 4000 rpm at 4°C for 10 minutes. Because of the clotting problems, re-clotting sometimes occurred in the serum samples after centrifuging. This was managed by manual removal of the clot from the sample tube followed by re- centrifuging.

After centrifuging, serum and plasma were pipetted into 500  $\mu$ l Microvettes® Sarstedt (Nümbrecht, Germany), which were then stored first at -20°C and transferred to -80°C within 24 h of blood withdrawal. Once frozen, samples were not allowed to thaw until laboratory analysis.

### 8. Removal of IV cannula

Prolonged bleeding, bruising

#### Standard protocols

The WHO guidelines on drawing blood recommend inspecting the puncture site and if bleeding occurs then applying gentle pressure on the puncture site until bleeding has stopped. If no bleeding occurred it is recommended to apply a bandage(4).

#### Adaptations made

For the prevention of bruising we applied gentle pressure to the puncture site for at least one minute. Thereafter participants were asked to apply gentle pressure for at least 2 minutes. A second inspection was made to check for bleeding, if bleeding occurred, gentle pressure was continued; if not then a bandage was placed. Extra attention was paid to older adults using anti-thrombotic medications.

## REFERENCES

1. **Greaney JL, and Farquhar WB.** Why do veins stiffen with advancing age? *J Appl Physiol* (1985). 2011;110(1):11-2.
2. **European Committee (Partial Agreement) on Blood Transfusion (CD-P-TS).** Guide to the preparation, Use and Quality Assurance of Blood Components. 16th ed., 2010
3. **Pearson TC, Guthrie DL, Simpson J, Chinn S, Barosi G, Ferrant A, Lewis SM, and Najean Y.** Interpretation of measured red cell mass and plasma volume in adults: Expert Panel on Radionuclides of the International Council for Standardization in Haematology. *Br J Haematol.* 1995;89(4):748-56.
4. **WHO Guidelines on Drawing Blood: Best Practices in Phlebotomy.** Geneva: World Health Organization.; 2010.
5. **Nikolac N, Supak-Smolcic V, Simundic AM, and Celap I.** Croatian Society of Medical Biochemistry and Laboratory Medicine: national recommendations for venous blood sampling. *Biochem Med (Zagreb).* 2013;23(3):242-54.
6. **Keyes LE, Frazee BW, Snoey ER, Simon BC, and Christy D.** Ultrasound-guided brachial and basilic vein cannulation in emergency department patients with difficult intravenous access. *Ann Emerg Med.* 1999;34(6):711-4.
7. **Elia F, Ferrari G, Molino P, Converso M, De Filippi G, Milan A, and Apra F.** Standard-length catheters vs long catheters in ultrasound-guided peripheral vein cannulation. *Am J Emerg Med.* 2012;30(5):712-6.
8. **Moureaux NL.** Tips for inserting an I.V. device in an older adult. *Nursing.* 2008;38(12):12.
9. **Stone BA.** Re: Ultrasound-guided peripheral intravenous access. *J Emerg Med.* 2014;46(2):228.
10. **Bertolino G, Pitassi A, Tinelli C, Staniscia A, Guglielmana B, Scudeller L, and Luigi Balduini C.** Intermittent flushing with heparin versus saline for maintenance of peripheral intravenous catheters in a medical department: a pragmatic cluster-randomized controlled study. *Worldviews Evid Based Nurs.* 2012;9(4):221-6.





# PART II

## Hypothalamic-pituitary-thyroid axis and longevity







# CHAPTER 4

## Human longevity is characterised by high thyroid stimulating hormone secretion without altered energy metabolism

Jansen SW\*, Akintola AA\*, Roelfsema F, van der Spoel E, Cobbaert CM, Ballieux BE, Egri P, Kvarta-Papp Z, Gereben B, Fekete C, Slagboom PE, van der Grond J, Demeneix BA, Pijl H, Westendorp RG, van Heemst D.  
*Scientific Reports*. 2015; 5. doi: 10.1038/srep11525.

\*equal contribution of authors



## ABSTRACT

Few studies have included subjects with the propensity to reach old age in good health, with the aim to disentangle mechanisms contributing to staying healthier for longer. The hypothalamic-pituitary-thyroid (HPT) axis maintains circulating levels of thyroid stimulating hormone (TSH) and thyroid hormone (TH) in an inverse relationship. Greater longevity has been associated with higher TSH and lower TH levels, but mechanisms underlying TSH/TH differences and longevity remain unknown. The HPT axis plays a pivotal role in growth, development and energy metabolism. We report that offspring of nonagenarians with at least one nonagenarian sibling have increased TSH secretion but similar bioactivity of TSH and similar TH levels compared to controls. Healthy offspring and spousal controls had similar resting metabolic rate and core body temperature. We propose that pleiotropic effects of the HPT axis may favour longevity without altering energy metabolism.

## INTRODUCTION

Worldwide, the population of elderly is rapidly growing, with numbers expected to further increase in the coming decades. Although epidemiological studies have discovered specific lifestyle and genetic risk factors for cardiovascular disease, dementia and cancer, age is unequivocally the major common risk factor(1). With the expansion of the ageing population, the prevalence of all major age related diseases will increase, including cardiovascular disease, diabetes mellitus (type 2) and dementia. Most studies have included diseased subjects with the aim to identify risk factors for specific diseases(2). Only few studies have included subjects with a propensity to reach old age in good health, with the aim to disentangle mechanisms contributing to healthy human longevity and protection from disease. The Leiden Longevity Study (LLS) comprises nonagenarians with at least one nonagenarian sibling, their offspring and the offspring's partners(3). Compared to their partners, offspring from nonagenarian siblings have a lower mortality rate, a lower prevalence of diabetes and cardiovascular disease(3) and are therefore well suited for studying the mechanisms underlying healthy human longevity.

Numerous theories of ageing link energy metabolism to the ageing process. The "rate of living theory" postulates that the positive correlation between lifespan and size implicates species differences in resting metabolic rate(4). The mechanistically linked "free radical theory of ageing" proposes that free radicals generated as by-products of oxidative metabolism underpin the negative correlation between life span and resting metabolic rate(5). Other theories propose ageing to involve precocious depletion of functional stem cell reserves(6) which might be retarded by slowing tissue turnover rates. One physiological integrator that influences metabolism, growth, development and tissue turnover is thyroid signalling. In previous studies, we found that when nonagenarians were stratified for their propensity to reach advanced age, those with the lowest family mortality history score had the highest TSH levels and slightly lower levels of free T4 (fT4) and free T3 (fT3)(7). When offspring were compared to their partners, fT4 levels were similar, whereas TSH was higher and fT3 levels were slightly lower(8, 9). Moreover studies in the oldest old from the general population also link increased levels of TSH with reduced old age mortality(10).

In this study, we are the first that make use of frequent blood sampling in relation with familial longevity to study TSH secretion and TH levels over 24 hours, because TSH and fT3 were shown to have circadian rhythms(11). In addition, we investigated whether such differences in TSH and/or TH concur with differences in energy metabolism, a physiological process that has been associated with longevity in model organisms and is known to be responsive to TSH/TH action.

## RESULTS

### Baseline characteristics

Between 2002 and 2006, 421 families with at least two long-lived Caucasian siblings, were recruited in the Leiden Longevity Study, without any selection on health. Males had to be aged 89 years or above and females 91 years or above (3, 12). For the current study (Switchbox) we included 61 offspring and 51 partners in which we measured energy metabolism (the full study sample) and 20 offspring and 18 partners (subgroup) in which we sampled blood continuously over 24 hours.

The baseline characteristics of both the full study sample as well as the subgroup are presented in Table 1. In the full study sample as well as in the subgroup, the groups of offspring from long-lived families and partners were of similar age, sex and BMI. Participants were selected on the basis of the age of their parents. Consequently, in both groups, mothers of offspring were significantly older ( $P < 0.001$ ), and in the full study sample the age of the offspring's fathers was significantly higher as well ( $P < 0.001$ ). In line with previous findings (3), offspring had less cardiovascular disease.

### TSH and thyroid hormones

Offspring from long-lived siblings had on average 0.8 mU/l higher serum concentrations of TSH at all time points over a 24-hour period (Fig. 1a). We calculated the area under the curve (AUC) to estimate hormone production over the 24-hour period, during the day period (9.00h-23.00h) and during the night (24.00h-06.00h). The mean (95% CI) TSH AUC over the 24-hour period was significantly ( $P = 0.009$ ) higher in the offspring (56.1 (45.7-66.5 mU/l)) compared to that of their partners (35.3 (24.4-46.3) mU/l) (Supplementary Table 1). Moreover, the mean (95% CI) TSH AUC was significantly higher during the day ( $P = 0.006$ ) as well as during the night ( $P = 0.025$ ) in the offspring compared to the partners thereof. The 24-hour profiles of fT4 (Fig. 1b) and fT3 (Fig. 1c) and the areas under the curves over the 24-hour period, during the day and night (Supplementary Table 1) did not differ between groups. We performed deconvolution analyses to quantify total TSH secretion over 24 hours on the basis of the TSH concentration profiles (13). Geometric mean (95% CI) total TSH secretion over 24 hours was significantly ( $P = 0.007$ ) higher in the offspring (55.0 (43.9-68.9) mU/l) compared to partners (34.4 (27.1-43.7) mU/l).

To ensure that the subgroup represented the full study sample, we replicated the TSH and TH measurements in a fasted single late morning sample for the 112 subjects from the full study sample (Table 2). Again, we found significantly increased ( $P = 0.01$ ) geometric mean (95% CI) serum concentrations of TSH in offspring (2.1 (1.8-2.3) mU/l) compared to partners (1.6 (1.4-1.9) mU/l), but no difference in TH serum concentrations.

**Table 1** Baseline characteristics of the full study sample and subgroup.

	Full study sample			Subgroup		P-value
	Offspring n=61	Partner n=51	P-value	Offspring n=20	Partner n=18	
<b>Demographics</b>						
Male n (%)	28 (45.9)	27 (52.9)	0.46	10 (50.0)	10 (55.6)	0.73
Age (years)	65.9 (6.4)	65.9 (6.1)	0.95	65.6 (5.4)	64.6 (4.9)	0.52
Age mother (years)†	89.7 (10.3)	77.5 (15.3)	<0.001	92.4 (7.9)	78.6 (13.9)	<b>0.001</b>
Age father (years)†	86.0 (15.1)	72.6 (11.5)	<0.001	82.5 (18.9)	76.8 (9.2)	0.25
BMI (kg/m <sup>2</sup> )	25.6 (3.6)	26.5 (4.3)	0.22	25.4 (4.0)	25.5 (3.9)	0.91
Fat mass (kg)*	23.9 (6.6)	26.4 (9.8)	0.13	23.5 (7.1)	23.7 (7.8)	0.93
Fat free mass (kg)*	51.4 (11.8)	53.1 (10.4)	0.42	51.3 (12.0)	52.5 (11.4)	0.75
<b>Medical history</b>						
Cardiovascular disease n (%)	2 (3.2)	7 (13.7)	<b>0.04</b>	0 (0)	1 (5.5)	0.29
Malignancies n (%)	7 (11.5)	2 (3.9)	0.14	3 (15.0)	0 (0)	0.09
Osteoporosis/arthritis n (%)	5 (8.2)	5 (9.8)	0.77	1 (5.0)	2 (11.1)	0.49
<b>Medication</b>						
Statins n (%)	4 (6.6)	9 (17.6)	0.07	0 (0)	1 (5.6)	0.29
Anti-hypertensive n (%)	11 (18.0)	17 (33.3)	0.06	3 (15.0)	2 (11.1)	0.72
<b>Laboratory results</b>						
Creatinine clearance (ml/min)	87.0 (21.2)	91.6 (27.1)	0.32	89.9 (18.7)	94.7 (22.0)	0.47
Aspartate Aminotransferase (U/l)	26.0 (8.9)	27.3 (13.1)	0.51	25.9 (6.2)	24.4 (6.9)	0.50
Alanine Aminotransferase (U/l)	25.0 (22.4)	24.4 (9.1)	0.86	23.4 (5.2)	23.1 (7.1)	0.88
<b>Lifestyle</b>						
Smoking current n (%)	1 (1.6)	1 (2.0)	0.90	0 (0)	1 (5.6)	0.29
Alcohol > 20 units/week n(%)	5 (8.2)	4 (7.8)	0.93	1 (5.0)	2 (11.1)	0.49

Unless indicated otherwise, data are presented as mean (standard deviation). \* Data were not available for 1 male partner due to technical problems.  
 † missing data of 3 participants in the full study sample

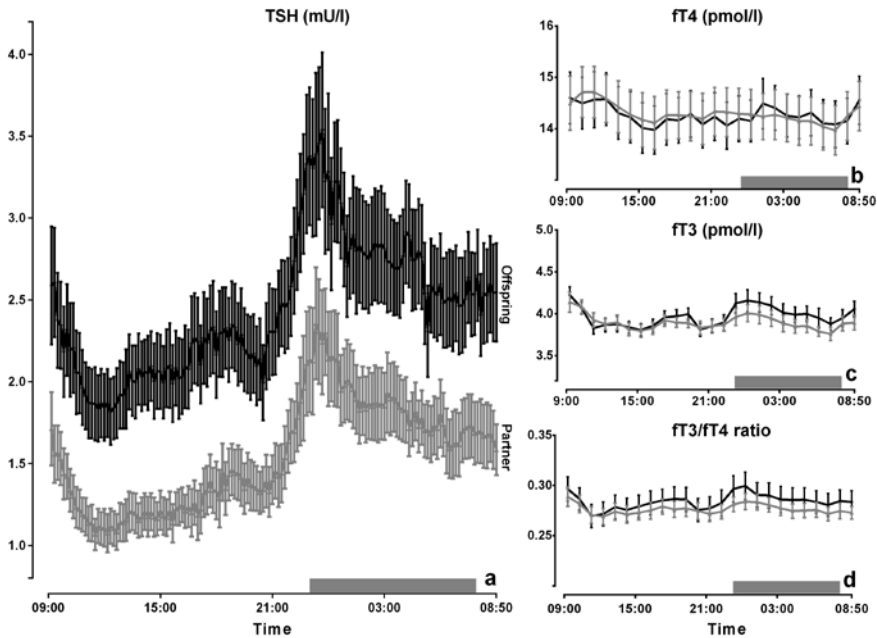

**Figure 1** Twenty-four hour profiles of TSH, fT4, fT3 and fT3/fT4 ratio in offspring from long-lived families and partners.

In all the panels, data points represent means with standard error of the mean. The black lines depict 20 offspring and the grey lines depict 18 partners. (a) Ten minutes measurements of TSH. Hourly measurements of (b) fT4 (c) fT3 (d) fT3/fT4 ratio. The grey bars represent lights-off periods (from 23:00-08:00).

### Regularity of consecutive serum TSH concentration measurements over 24 hours

ApEn was used as a regularity statistic to quantify the regularity or orderliness of consecutive serum TSH concentration measurements over 24 hours, with a higher ApEn indicating a greater irregularity(14, 15). Geometric mean (95% CI) ApEn of TSH was similar between offspring and partners ((1.26 (1.13-1.41) versus (1.15 (1.02-1.29)  $P = 0.22$ )).

### Relationship between circulating TSH and fT4

In the human population, the HPT axis maintains circulating TSH and thyroid hormone levels in a physiological inverse relationship. We calculated the fT4xTSH product and the fT4/TSH ratio to further characterize the relationship between circulating TSH and fT4 in offspring and partners. In both the full study sample and in the subgroup we

found a significantly higher  $fT4 \times TSH$  product in offspring compared to partners (Table 2). In the full study sample and subgroup,  $fT4/TSH$  ratio was significantly lower in the offspring compared to the partner group (Table 2). In addition, in the subgroup, offspring had a significantly lower ( $P = 0.01$ ) geometric mean (95% CI) AUC  $fT4$ /total TSH production ratio (6.1 (4.8- 7.8)) compared to partners (9.7 (7.5- 12.7)).

### Estimates of peripheral deiodination

A possible mechanism that could underlie the offspring's increased TSH secretion is enhanced TH turnover due to increased uptake in tissues or hormone clearance. Amongst others, one process that could contribute to peripheral TH turnover is deiodination(16). To estimate conversion of  $fT4$  into  $fT3$ , we calculated the  $fT3/fT4$  ratio in both the full study sample and in the subgroup (table 2). In both the full study sample as in the subgroup no significant differences in  $fT3/fT4$  ratio were found between offspring and partners thereof. Moreover, we calculated the  $AUCfT3/AUCfT4$  ratio in the subgroup only, as a more precise measure of deiodination over the whole 24-hour period. However, no significant difference was observed in mean (95% CI)  $AUCfT3/AUCfT4$  ratio between offspring and partners (6.8 (6.3-7.2) versus (6.6 (6.1-7.0),  $P = 0.56$ )). Deiodinase 1 and deiodinase 2 are responsible for the generation of T3 from T4, whereas deiodinase 3 is the major inactivating enzyme leading to an increase of reverse T3 ( $rT3$ ). The ratio between T3 and  $rT3$  ( $T3/rT3$  ratio) is therefore regarded as a more sensitive marker of peripheral thyroid hormone metabolism(17-19). No significant difference was observed in  $T3/rT3$  ratio between offspring and partners in both the full study sample as well as in the subgroup (Table 2). Also after exclusion of 1 female partner, who had a  $rT3$  measurement above the reference range, no difference was found between offspring and partners in the mean (95% CI)  $T3/rT3$  ratio (6.8 (6.3-7.2) versus 6.5 (5.9-7.0)  $P = 0.39$ ).

### TSH bioactivity

We determined TSH bioactivity *in vitro* to assess whether the offspring's increased TSH secretion was a compensatory mechanism for reduced TSH bioactivity. We first assessed if the TSH levels in the sample in which we wanted to measure TSH bioactivity were higher in the offspring (Fig. 2a). Again, we found a significant ( $P < 0.02$ ) higher mean (95% CI) TSH level in offspring (2.2 (1.7-2.8) mU/l) compared to partners thereof (1.4 (1.1-1.8) mU/l). To determine whether the bioactivity of TSH molecules was different between the groups, the total amount of cAMP produced was adjusted for sample TSH concentrations, by calculating the cAMP/TSH ratio which was similar for offspring and partners (Fig. 2b).

**Table 2** Thyroid status in offspring from long-lived siblings and partners.

	Full study sample*			Subgroup		
	Offspring (n=61)	Partner (n=51)	P-value	Offspring (n=20)	Partner (n=18)	P-value
<b>Hormone levels (rv)</b>						
TSH (0.3-4.8 mU/l)†	2.1 (1.8-2.3)	1.6 (1.4-1.9)	<b>0.01</b>	2.2 (1.7-2.8)	1.4 (1.1-1.8)	<b>0.02</b>
fT4 (10-24 pmol/l)	16.1 (15.5-16.7)	16.5 (15.9-17.1)	0.36	14.7 (13.7-15.7)	14.5 (13.5-15.5)	0.78
fT3 (4.7-8.2 pmol/l)	4.7 (4.6-4.8)	4.6 (4.5-4.8)	0.49	4.2 (4.10-4.4)	4.1 (3.9-4.3)	0.36
T3 (1.1-3.1 nmol/l)‡	1.66 (1.59-1.72)	1.62 (1.55-1.68)	0.37	1.50 (1.42-1.57)	1.48 (1.40-1.56)	0.72
rT3 (0.11-0.44 nmol/l)‡	0.26 (0.24-0.28)	0.27 (0.25-0.29)	0.30	0.18 (0.16-0.20)	0.17 (0.15-0.19)	0.57
fT4xTSH product †	33.0 (29.0-37.4)	26.4 (23.0-30.3)	0.02	31.7 (25.0-40.0)	20.4 (15.9-26.2)	0.01
fT4/TSH ratio †	6.7 (5.2-8.6)	10.1 (7.7-13.2)	0.03	7.7 (6.7-8.8)	10.1 (8.7-11.8)	0.01
fT3/fT4 ratio	0.30 (0.29-0.31)	0.29 (0.27-0.30)	0.20	0.30 (0.28-0.32)	0.29 (0.27-0.31)	0.55
T3/rT3 ratio‡	6.77 (6.28-7.25)	6.36 (5.84-6.88)	0.26	8.84 (7.80-9.88)	9.24 (8.13-10.34)	0.60

Unless otherwise indicated data are displayed as means with 95% CI adjusted for age and sex. \*data were not available in the full study sample for 2 offspring and 2 partners for analyses of fT4, fT3, TSHxft4 product, fT4/TSH ratio and fT3/fT4 ratio; †geometric mean with 95% CI; ‡ data were not available for 4 offspring and 1 partner for analysis due to limited amount of blood. rv: reference values



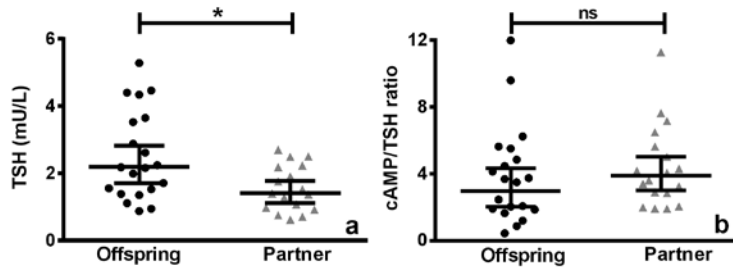

**Figure 2** *In vitro* TSH bioactivity in offspring from long-lived siblings and partners.

Black circles represent 20 offspring, grey triangles represent 18 partners. Solid lines represent (a) geometric mean with 95% CI of TSH levels (mU/l) (b) geometric mean with 95% CI of cAMP/TSH ratio.

\*  $P < 0.05$ ; ns: not significant.

## Metabolism

Mean (95% CI) resting metabolic rate did not significantly differ between offspring and partners in the full study sample (960 (924-997) kcal/day versus (987 (947-1026) kcal/day,  $P = 0.34$ )) nor in the subgroup (Fig. 3a). Adjustments for age and sex did not materially change the results. Moreover, resting metabolic rate per kg fat free mass (FFM) did not differ between offspring and partners in both groups (Fig. 3b). There was no difference in core body temperature over the 3 day period between offspring and partners in the full study sample (Fig. 3c) or in the subgroup.

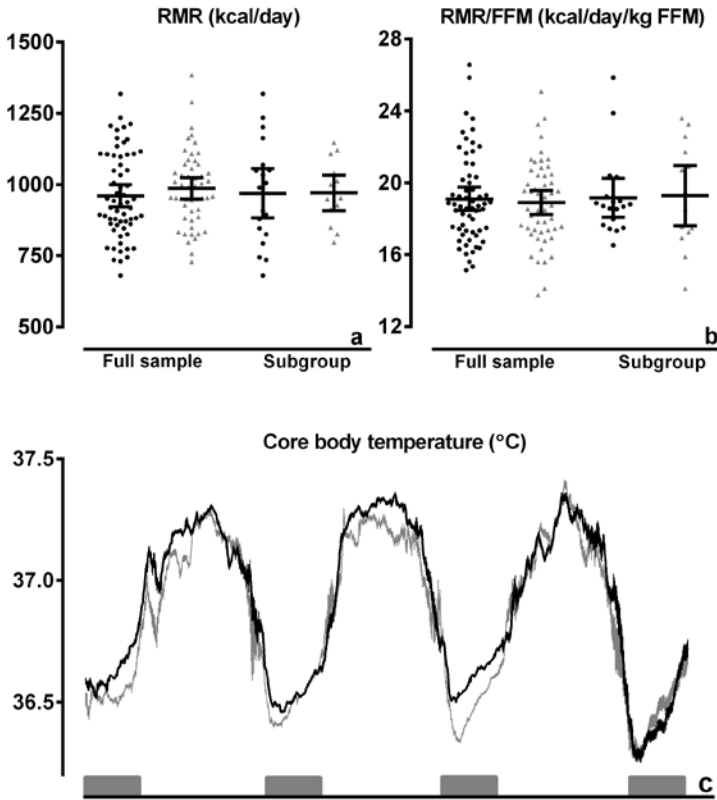

**Figure 3** Parameters of energy metabolism in offspring from long-lived siblings and partners.

Black circles represent offspring (n=61 for full study sample; n=20 for subgroup) and grey triangles represent partners (n=51 for full study sample; n=18 for subgroup). (a) Mean (95% CI) resting metabolic rate (kcal/day). (b) Mean (95% CI) resting metabolic rate per kg fat free mass (c) Mean (SEM) core body temperature per 5 minutes over 3 days in full study sample offspring (black line) and partners (grey line). Grey blocks are the night periods (24.00h - 07.00h). RMR: resting metabolic rate; FFM: fat free mass. \*  $P \leq 0.05$ ; \*\*  $P \leq 0.01$ ; ns: not significant.

## DISCUSSION

In this study, we investigated if human longevity is associated with differences in TSH and/or TH and whether these concur with differences in energy metabolism because this process is responsive to TSH/TH action and has been associated with longevity in model organisms. The main finding of this study is that familial longevity is characterized by higher TSH secretion, in the absence of differences in TH levels and metabolism.

The association of higher TSH with familial longevity is in line with our earlier observations in nonagenarians from the Leiden Longevity Study(7) and their offspring(9) as well as with earlier observations in Ashkenazi centenarians and their offspring(20). In line with the data described in this article, higher TSH in Ashkenazi centenarians and their offspring was not associated with lower concentrations of circulating thyroid hormone levels(20). In contrast, previously we did find slightly lower levels of thyroid hormones in offspring from long-lived siblings(8) and we also found that nonagenarians from families with the lowest family mortality history score had relatively lower levels of thyroid hormones(7). However, these previous studies were performed using non-fasted single blood samples randomly taken over the day and there were no(7) or less stringent(8) selection criteria on health status of the participants, which can both influence TH levels. In addition, the observed differences between offspring and partners with respect to the thyroid hormones were very small(8). In the current study, to reduce confounding by health status, we used more strict inclusion criteria (as described in the methods) and to reduce confounding by sampling time, all comparisons of serum TSH and thyroid hormone measurements between groups were standardized for sampling time.

The observation that despite increased levels of TSH, levels of TH were similar between groups aligns with the observation that energy metabolism was not different between groups. Metabolic rate is inversely associated with longevity in different animals and metabolism plays a central role in several ageing theories. In turn, administration of TH is well known to increase metabolic rate in diverse species, including humans. Recent studies in animals have also implicated central mechanisms in the effects of T3 on increased metabolism(21). We did not find differences in resting metabolic rate or core body temperature between the offspring and the partners in the full study sample nor in the subgroup. This is remarkable, since many ageing theories and longevity models in animals are related to changes in energy metabolism. These findings align with the observation that despite increased levels of TSH, levels of TH were similar between groups. Also the fT3/fT4 ratio, as a proxy for conversion of fT4 into fT3 was comparable between offspring and partners both in the full study sample and in the subgroup. Moreover in the subgroup the AUCfT3/AUCfT4 ratio over the 24-hour period did not significantly differ between offspring and partners.

Several possible mechanisms can contribute to the observed increase in TSH in the offspring group, including (i) reduced bioactivity of circulating TSH, (ii) diminished sensitivity of thyrotrophs to negative feedback by thyroid hormones, (iii) diminished responsiveness of the thyroid gland to TSH, (iv) enhanced thyroid hormone turnover in peripheral tissues and (v) enhanced clearance of thyroid hormones from the circulation.

The bioactivity of circulating TSH is known to differ depending on the degree of glycosylation and sialylation. A lower TSH bioactivity in the offspring would require higher concentrations of circulating TSH to maintain circulating thyroid hormone levels. In our study sample, TSH bioactivity, as reflected by the cAMP/TSH ratio in an *in vitro* activity assay, was similar in the offspring and partners.

To explore the possibility that the offspring might have higher TSH because of diminished sensitivity of thyrotrophs to negative feedback by thyroid hormones, we calculated the fT4xTSH product and found that it was higher in the offspring group. Previously, the fT4xTSH product has been used to quantitate the sensitivity of the thyrotrophs to feedback regulation by thyroid hormone and the degree of inherited thyroid hormone resistance(22). Although all subjects with inherited thyroid hormone resistance had higher serum concentrations of fT4 for corresponding TSH concentrations, the degree of thyroid hormone resistance differed depending on the type of mutation, which was reflected by the fT4xTSH product(22). Thus, a higher thyrotroph T4 resistance index in the offspring might be indicative of reduced sensitivity of the thyrotrophs to feedback regulation by thyroid hormone. However, there are two observations that might argue against this interpretation. First, one would expect the increased TSH secretion to result in an increase in fT4 concentrations. However, in contrast to subjects with thyroid hormone resistance(22), circulating thyroid hormone levels were not higher in the offspring. Second, the ApEn of TSH secretion was not significantly different in the subgroup between offspring and partners. ApEn of TSH was used as a regularity statistic to quantify the regularity or orderliness of TSH secretion, with a higher ApEn indicating a greater irregularity. Mathematical models and feedback experiments have established that pattern orderliness monitors feedback and/or feedforward interactions within different hypothalamic-pituitary target-organ systems with high sensitivity and specificity(14). With regard to TSH secretion, previous studies have shown that the ApEn of TSH secretion is greatly increased in patients with severe hypothyroidism, but not in subjects with subclinical hypothyroidism or in controls(15). Thus, in severe hypothyroid patients, the failure of the thyroid gland to produce sufficient amounts of thyroid hormone will lead to loss of thyroid hormone mediated feedback on TRH and TSH secretion, and this was reflected by an increase in the irregularity of TSH secretion (higher ApEn of TSH secretion). In contrast, in patients with subclinical hypothyroidism, thyroid hormone levels are within the normal range, and the ApEn of TSH secretion was unchanged, reflecting intact thyroid hormone mediated feedback on TRH and TSH secretion(23).

An alternative interpretation for the increased fT4xTSH product in offspring is that it reflects higher serum concentrations of TSH for corresponding fT4 concentrations. This finding may thus hint more towards reduced responsiveness of the thyroid gland to TSH, driving production of TSH to maintain sufficient circulating fT4 and fT3 levels. We further explored the possibility that TSH secretion could compensate for reduced responsiveness of the thyroid gland by calculating the fT4/TSH ratio in the full study sample and the AUC fT4/total TSH production ratio. We found that these ratios were significantly lower in the offspring lending support to the possibility that their thyroid gland is likely to be less responsive to TSH than the thyroid gland of their partners.

A fourth possible mechanism underlying increased TSH secretion is enhanced TH turnover. The fT3/fT4 ratio, a proxy for conversion of fT4 into fT3 did not differ between offspring and partners. However, while circulating levels of fT4 and fT3 are kept within narrow ranges, TH levels exhibit much wider variation within target tissues due to intense and highly regulated control of tissue-specific TH action by deiodinases, transporters and transcriptional co-regulators. Thus, we cannot exclude the possibility that TSH levels are increased in familial longevity due to increased TH turnover in target tissues. Although we did not have data on deiodinase activity in specific target tissues, circulating T3/rT3 ratio was shown to exhibit a strong and positive correlation with liver deiodinase 1 activity(17). In our study, no differences were found between offspring and partners in the T3/rT3 ratio. Taken together, enhanced TH turnover by increased peripheral turnover of TH is less likely to be an underlying mechanism of the increased TSH secretion.

It should be noted that the sample size of the current study is relatively small and that differences that did not reach statistical significance in our study sample might be clinically significant. The families included in the Leiden Longevity Study are genetically heterogeneous, and thus different mechanisms may be at play in different families and/or in different individuals.

A fifth possible mechanism underlying increased TSH secretion is that the offspring may have an enhanced rate of thyroid hormone clearance from the circulation, which would trigger the pituitary to secrete more TSH, stimulating the production of thyroid hormones to ensure appropriate circulating TH concentrations. Unfortunately, we did not have data on thyroid hormone clearance by the liver and kidneys to evaluate this possibility.

Thus, our data cannot discriminate which mechanism is responsible for the altered thyroid status in familial longevity and what the physiological consequences are of the observed increased TSH secretion. Future studies should aim to disentangle the causes and consequences of the altered thyroid status by TSH and TH challenges.

Moreover, this study did not investigate other processes that might be influenced by differences in TSH and/or TH and that might be relevant for longevity. One such key process is tissue turnover. In adult mammalian tissues, damaged and worn-out

mature cells are continuously being replaced during normal tissue homeostasis and in response to stresses and injury, a process that is critically dependent on the differentiation of self-renewing, tissue-specific stem cells. Various theories propose that ageing implicates either depletion or failed differentiation of stem cells(6). The TSH receptor (TSHR), a G-protein coupled hormone receptor, plays an important role in growth and differentiation of thyroid follicular cells. However, TSHR expression is not limited to the thyroid. TSHR is also expressed on bone cells(24, 25) and other cells, including adipocytes, hepatocytes, skeletal muscle cells, neuronal cells, astrocytes and mesenchymal stem cells(26-28). In mesenchymal stem cells TSH induces gene expression patterns that have been implicated in functions related to stem cell fate, including self-renewal, differentiation and maintenance(26). TSH is also involved in cellular differentiation in other cells with effects depending on the stage of differentiation, e.g. TSH stimulated early differentiation of preadipocytes but inhibited their proliferation and terminal differentiation(29). However, because of the physiological inverse relationship between TSH and thyroid hormones, and the critical role of thyroid hormone in development, the extrathyroidal effects of TSH in the skeleton and other tissues remain controversial(24).

A strength of our study is that we frequently measured hormone levels over a 24-hour period. Therefore, we were able to standardize comparison of hormone levels between groups for clock time and were able to explore differences in total TSH secretion using deconvolution analysis. Another strength is that we simultaneously measured several physiological parameters known to be affected by thyroid hormones. Since we included offspring enriched for longevity and compared them with their partners, we had a matched control group. One of the weaknesses of the study is that not all offspring are enriched for longevity causing us to underestimate actual effects. Moreover, the invasive nature and the high costs of hormone rhythm studies make it impossible to perform such studies using a large sample size and relatively small but clinically significant differences between groups may not be detected.

The principal finding of this study is that familial longevity is characterized by higher TSH secretion, in the absence of differences in TH concentration and in whole body energy metabolism. Taken together, these observations suggest that pleiotropic effects of the HPT axis protect long-lived families. Further in depth mechanistic studies should focus on disentangling the underlying mechanism.

## Methods

**Participants.** Between 2002 and 2006, 421 families with at least two long-lived Caucasian siblings, 1671 of their offspring and 744 of the offspring's partners were recruited in the Leiden Longevity Study, without any selection on health. Males had to be aged 89 years or above and females 91 years or above(3, 12). For the current

study (Switchbox), between March 2012 and July 2013, 135 offspring and partners from the LLS were measured at the study centre of the Leiden University Medical Centre. Inclusion criteria included being middle-aged (55-77 years) and having a stable body mass index (BMI) between 19 kg/m<sup>2</sup> and 33 kg/m<sup>2</sup>. Participants were excluded if their fasting plasma glucose was above 7 mmol/l, if they had any significant chronic, renal, hepatic or endocrine disease, or if they used any medication known to influence lipolysis, thyroid function, glucose metabolism, GH/IGF-1 secretion or any other hormonal axis. Moreover, participants were excluded if they had a recent trans meridian flight, smoking addiction, use of more than 20 units of alcohol per week and extreme diet therapies. Other exclusion criteria specific for the subgroup only, were difficulties to insert and maintain an intravenous catheter, anemia (hemoglobin < 7.1 mmol/l), and blood donation within the last two months. Based on information obtained via telephone questioning, controls with a nonagenarian parent who had one or more nonagenarian siblings were also excluded. All women in this study were postmenopausal. The Switchbox protocol was approved by the Medical Ethical Committee of the Leiden University Medical Centre and was performed according to the Helsinki declaration. All participants gave written informed consent for participation.

Of the 135 subjects included, we excluded from analysis 17 subjects due to incomplete indirect calorimetry data and 6 subjects due to incomplete core body temperature data ( Supplementary Fig. 1). Thus, data from 112 subjects (61 offspring, 51 partners) were available for analysis (and are referred to as full study sample). Complete series of 24-hour blood samples were obtained for a subgroup of 38 participants (20 offspring, 18 partners).

**Continuous blood sampling.** Participants were sampled in the same research room and received standardized feeding at three fixed times during the day (between 09.00h-10.00h, 12.00h-13.00h and 18.00-19.00h), each consisting of 600 kcal Nutridrink (Nutricia Advanced Medical Nutrition, Zoetermeer, The Netherlands). No naps were allowed during the day and lights were turned off between 23.00h to 08.00h. A catheter was placed in a vein of the forearm of the non-dominant hand. Every 10 minutes, 1.2 ml of blood was collected in K<sub>3</sub>-EDTA tube and 2 ml in a serum-separator (SST)-tube. In total, 460.8 ml of blood was withdrawn from each participant.

**Processing of the samples.** After blood withdrawal, the K3-EDTA tubes were immediately placed on ice before centrifugation. Serum tubes were kept at room temperature and centrifuged when the samples were clotted, usually between 30-60 minutes. Samples were centrifuged at 3520 RPM at 4°C for 10 minutes. The EDTA plasma and serum samples were stored in two aliquots of 500µl during the rest of the sampling at -20°C. After the sampling they were transferred to a -80°C freezer until analysis.

**Chemical analyses.** All measurements were performed at the Department of Clinical Chemistry and Laboratory Medicine, Leiden University Medical Centre, The Netherlands. All laboratory measurements were performed with fully automated equipment and diagnostics from Roche Diagnostics (Almere, The Netherlands). Aspartate Aminotransferase (AST) (Catalog number 11876848216), Alanine Aminotransferase (ALT) (Catalog number 11876805216) and creatinine (Catalog numbers R1 11875566216, R2 11875582216) were measured from a fasted late morning serum sample using the Modular P800 clinical chemistry analyser. TSH (Catalog number 11731459122), fT4 (Catalog number 6437281190), fT3 (Catalog number 13051986190), and T3 (Catalog number 11731360122) were measured in serum by ElectroChemo-Luminescence ImmunoAssay (ECLIA) using a Modular E170 Immunoanalyzer. The TSH method has been standardized against the 2nd IRP WHO Reference Standard 80/558. For each participant, all samples from one time series were measured with the same lot number in the same batch. For fT4 and fT3, all samples were measured in one batch. For TSH, measurements were made in 10 batches. For each couple, offspring and partner were measured with the same lot number and preferentially also in the same batch. For this study, the precision and quality of all assayed analytes met or surpassed the level of desirable quality specifications(30). The coefficients of variation (CVs) for AST, ALT, creatinine, and fT3 were all below their advised levels of 6.0% for AST, 12.2% for ALT, 2.2% for creatinine, and 4.4% for T3. For TSH, fT4 and fT3 Randox controls (catalog numbers IA 3109 and IA 3111) were used to determine the CVs. For TSH, the CV ranged in our study between 1.41-4.16, which was well below the desired CV of 9.9%. For fT4, the CV range in our study was 2.41-3.49 and for fT3 2.16-2.91, both well below the upper CV limits for desired precision of these assays (fT4  $\leq$  3.8 and fT3  $\leq$  4.0). In our laboratory, the reference values for TSH were 0.3-4.8 mU/l, for fT4 10-24 pmol/l, for fT3 3-8pmol/l and for T3 1.1-3.1 nmol/l.

**rT3 measurements.** All rT3 measurements were measured in the same batch for both the full study sample as well as for the subgroup. Serum rT3 levels were measured with in-house radioimmunoassays by the Laboratory of Endocrinology and Radiochemistry of the Academic Medical Centre in Amsterdam(31) with an intra-assay variation between 4-5% and an inter-assay variation between 5-9% and a detection limit of 0.03 nmol/l. The reference range of rT3 was 0.11-0.44 nmol/l.

**Measurements of metabolism.** On study day 1, between 12.00h and 13.00h, participants had a 30 minutes indirect calorimetry session using a ventilated hood system (Care Fusion Canopy Jaeger Oxycon Pro, Houten, The Netherlands) after 14 hours of fasting. Participants were kept under standardised conditions, lying awake and emotionally undisturbed, completely at rest and comfortably supine on a bed, their head under a transparent ventilated canopy, in a thermally neutral environment. From the  $VO_2$  and  $VCO_2$  measurements, resting metabolic rate (RMR) was calculated using the formula  $3.91 VO_2 + 1.10 VCO_2 - 1.93N$ (32).



Body composition was measured using a Bioelectrical Impedance Analysis meter at a fixed frequency of 50kHz (Bodystat® 1500 Ltd, Isle of Man, British Isles)(33). Participants wore the Equival monitor (Equival EQ02 SEM, Hidalgo, UK) for the measurements of core body temperature (CBT) for five consecutive days (Supplementary Fig. 2).

**Data processing of the core body temperature.** In order to assess core body temperature, each participant swallowed one Core Body Temperature Capsule (Capsule REF 500-0100-02, Respirationics Inc., Murrysville, PA, USA) at each of three consecutive days, during dinner time (Supplementary Fig. 2). The capsule measured the core body temperature at a frequency of 250 ms and was connected with the Equival device by radio emission, with a maximum range of one meter. The acceptable core body temperature sensing range of the capsule is from 32°C to 42°C, according to factory settings. After a variable number of hours or days the core temperature capsule was discarded with the faeces.

Means per 5 minutes were calculated based on measurements every 15 seconds, temperature measurements  $\leq 35^{\circ}\text{C}$  or  $\geq 41^{\circ}\text{C}$  were excluded, and the first 5 hours after ingestion of the pill were removed to limit the influence of intake of food on the core body temperature measurements before passage through the stomach(34).

**Single measurements of thyroid hormones.** Fasted blood samples were taken in the late morning for the measurement of TSH, fT4 and fT3.

**TSH bioactivity.** For the *in vitro* measurement of TSH bioactivity we used the 09.10h K<sub>3</sub>-EDTA-samples of the 38 participants who were frequently sampled over 24 hours. We measured the biological activity of TSH *in vitro* according to our established protocol based on the recommendation of the American Thyroid Association Guide by measuring intracellular cAMP production of cultured Chinese hamster ovary cells stably transfected with the human TSH receptor (kindly provided by Dr. AC Bianco, Chicago, USA)(35, 36). The levels of cAMP were measured using a double-antibody radioimmunoassay kit (adenosine 3'5'cyclic monophosphate, PerkinElmer®, Massachusetts, USA).

**Deconvolution analysis.** The 24-hour TSH secretion was analyzed using a recently validated deconvolution method(13).

**Approximate entropy (ApEn).** ApEn of TSH was used as a regularity statistic to quantify the regularity or orderliness of consecutive serum TSH concentration measurements over 24 hours. Mathematical models and feedback experiments establish that pattern orderliness monitors feedback and/or feed-forward interactions within an interlinked axis with high sensitivity and specificity, both greater than 90%(37). Reduced pattern regularity typifies hormone secretion in puberty and ageing, during diminished negative feedback or fixed exogenous stimulation, and by autonomous neuroendocrine tumours(38).

**Statistical analysis.** Descriptive statistics were used to summarise the characteristics of both study groups. Chi square test and t-test were used to describe differences between offspring and partners regarding sex, age, age of the parents, body composition, medical history, medication, creatinine clearance, liver function tests, smoking and alcohol use. To calculate differences in secretion between offspring and partner for the different thyroid status parameters, areas under the curves were calculated according to the trapezoid method using SigmaPlot for Windows Version 11.0 (Systat Software, GmbH, Erkrath, Germany). The areas under the curves were calculated over the 24 hours, during the day from 09.00h to 23.00h and during the night from 24.00h to 06.00h. Linear regression was used to compare total TSH secretion, levels of TH, T3, rT3, measurements of AUCs, levels of cAMP/TSH ratio, AUCfT4/total TSH secretion, fT4/TSH ratio, fT4xTSH product, fT3/fT4 ratio, T3/rT3 ratio, AUC fT3/AUC fT4 ratio and parameters of the energy metabolism between offspring and partners adjusted for age and sex. When not normally distributed, parameters were log transformed for analysis, and data are presented as geometric mean with 95% confidence interval. Because ApEn of TSH was still not normally distributed after log transformation, a non-parametric test was used. For all above mentioned analyses the Statistical Package for the Social Sciences program for Windows, version 20 (SPSS, Chicago, IL) was used. Graphs were made using GraphPad Prism version 5 (GraphPad, San Diego, CA).

## REFERENCES

1. **Rae MJ, Butler RN, Campisi J, de Grey AD, Finch CE, Gough M, Martin GM, Vijg J, Perrott KM, and Logan BJ.** The demographic and biomedical case for late-life interventions in aging. *Sci Transl Med.* 2010;2(40):40cm21.
2. **Abbott A.** Ageing: growing old gracefully. *Nature.* 2004;428(6979):116-8.
3. **Westendorp RG, van Heemst D, Rozing MP, Frolich M, Mooijaart SP, Blauw GJ, Beekman M, Heijmans BT, de Craen AJ, Slagboom PE, and Leiden Longevity Study G.** Nonagenarian siblings and their offspring display lower risk of mortality and morbidity than sporadic nonagenarians: The Leiden Longevity Study. *J Am Geriatr Soc.* 2009;57(9):1634-7.
4. **Pearl R.** The Rate of Living. *New York: Knopf.* 1928.
5. **Harman D.** Free radical theory of aging. *Triangle.* 1973;12(4):153-8.
6. **Campisi J.** Cancer and ageing: rival demons? *Nat Rev Cancer.* 2003;3(5):339-49.
7. **Rozing MP, Houwing-Duistermaat JJ, Slagboom PE, Beekman M, Frolich M, de Craen AJ, Westendorp RG, and van Heemst D.** Familial longevity is associated with decreased thyroid function. *J Clin Endocrinol Metab.* 2010;95(11):4979-84.
8. **Rozing MP, Westendorp RG, de Craen AJ, Frolich M, Heijmans BT, Beekman M, Wijisman C, Mooijaart SP, Blauw GJ, Slagboom PE, van Heemst D, and Leiden Longevity Study G.** Low serum free triiodothyronine levels mark familial longevity: the Leiden Longevity Study. *J Gerontol A Biol Sci Med Sci.* 2010;65(4):365-8.
9. **Bowers J, Terrien J, Clerget-Froidevaux MS, Gothie JD, Rozing MP, Westendorp RG, van Heemst D, and Demeneix BA.** Thyroid hormone signaling and homeostasis during aging. *Endocr Rev.* 2013;34(4):556-89.
10. **Gusseklou J, van Exel E, de Craen AJ, Meinders AE, Frolich M, and Westendorp RG.** Thyroid status, disability and cognitive function, and survival in old age. *JAMA.* 2004;292(21):2591-9.
11. **Russell W, Harrison RF, Smith N, Darzy K, Shalet S, Weetman AP, and Ross RJ.** Free triiodothyronine has a distinct circadian rhythm that is delayed but parallels thyrotropin levels. *J Clin Endocrinol Metab.* 2008;93(6):2300-6.
12. **Schoenmaker M, de Craen AJ, de Meijer PH, Beekman M, Blauw GJ, Slagboom PE, and Westendorp RG.** Evidence of genetic enrichment for exceptional survival using a family approach: the Leiden Longevity Study. *Eur J Hum Genet.* 2006;14(1):79-84.
13. **Keenan DM, Roelfsema F, Biermasz N, and Veldhuis JD.** Physiological control of pituitary hormone secretory-burst mass, frequency, and waveform: a statistical formulation and analysis. *Am J Physiol Regul Integr Comp Physiol.* 2003;285(3):R664-73.
14. **Veldhuis JD, Straume M, Iranmanesh A, Mulligan T, Jaffe C, Barkan A, Johnson ML, and Pincus S.** Secretory process regularity monitors neuroendocrine feedback and feedforward signaling strength in humans. *Am J Physiol Regul Integr Comp Physiol.* 2001;280(3):R721-9.
15. **Roelfsema F, Pereira AM, Adriaanse R, Endert E, Fliers E, Romijn JA, and Veldhuis JD.** Thyrotropin secretion in mild and severe primary hypothyroidism is distinguished by amplified burst mass and Basal secretion with increased spikiness and approximate entropy. *J Clin Endocrinol Metab.* 2010;95(2):928-34.
16. **Gereben B, Zavacki AM, Ribich S, Kim BW, Huang SA, Simonides WS, Zeold A, and Bianco AC.** Cellular and molecular basis of deiodinase-regulated thyroid hormone signaling. *Endocr Rev.* 2008; 29(7):898-938.
17. **Peeters RP, Wouters PJ, van Toor H, Kaptein E, Visser TJ, and Van den Berghe G.** Serum 3,3',5'-triiodothyronine (rT3) and 3,5,3'-triiodothyronine/rT3 are prognostic markers in critically ill patients and are associated with postmortem tissue deiodinase activities. *J Clin Endocrinol Metab.* 2005; 90(8):4559-65.
18. **Peeters RP, van der Deure WM, and Visser TJ.** Genetic variation in thyroid hormone pathway genes; polymorphisms in the TSH receptor and the iodothyronine deiodinases. *Eur J Endocrinol.* 2006;155(5):655-62.
19. **de Jong FJ, Peeters RP, den Heijer T, van der Deure WM, Hofman A, Uitterlinden AG, Visser TJ, and Breteler MM.** The association of polymorphisms in the type 1 and 2 deiodinase genes with circulating thyroid hormone parameters and atrophy of the medial temporal lobe. *J Clin Endocrinol Metab.* 2007;92(2):636-40.

20. **Atzmon G, Barzilai N, Surks MI, and Gabriely I.** Genetic predisposition to elevated serum thyrotropin is associated with exceptional longevity. *J Clin Endocrinol Metab.* 2009;94(12):4768-75.
21. **Lopez M, Varela L, Vazquez MJ, Rodriguez-Cuenca S, Gonzalez CR, Velagapudi VR, Morgan DA, Schoenmakers E, Agassandian K, Lage R, Martinez de Morentin PB, Tovar S, Nogueiras R, Carling D, Lelliott C, Gallego R, Oresic M, Chatterjee K, Saha AK, Rahmouni K, Dieguez C, and Vidal-Puig A.** Hypothalamic AMPK and fatty acid metabolism mediate thyroid regulation of energy balance. *Nat Med.* 2010;16(9):1001-8.
22. **Yagi H, Pohlenz J, Hayashi Y, Sakurai A, and Refetoff S.** Resistance to thyroid hormone caused by two mutant thyroid hormone receptors beta, R243Q and R243W, with marked impairment of function that cannot be explained by altered in vitro 3,5,3'-triiodothyronine binding affinity. *J Clin Endocrinol Metab.* 1997;82(5):1608-14.
23. **Roelfsema F, and Veldhuis JD.** Thyrotropin secretion patterns in health and disease. *Endocr Rev.* 2013;34(5):619-57.
24. **Bassett JH, and Williams GR.** Critical role of the hypothalamic-pituitary-thyroid axis in bone. *Bone.* 2008;43(3):418-26.
25. **Zhang W, Zhang Y, Liu Y, Wang J, Gao L, Yu C, Yan H, Zhao J, and Xu J.** Thyroid-stimulating hormone maintains bone mass and strength by suppressing osteoclast differentiation. *J Biomech.* 2014;47(6):1307-14.
26. **Bagriacik EU, Yaman M, Haznedar R, Sucak G, and Delibasi T.** TSH-induced gene expression involves regulation of self-renewal and differentiation-related genes in human bone marrow-derived mesenchymal stem cells. *J Endocrinol.* 2012;212(2):169-78.
27. **Crisanti P, Omri B, Hughes E, Meduri G, Hery C, Clauser E, Jacquemin C, and Saunier B.** The expression of thyrotropin receptor in the brain. *Endocrinology.* 2001;142(2):812-22.
28. **Endo T, and Kobayashi T.** Expression of functional TSH receptor in white adipose tissues of hyt/hyt mice induces lipolysis in vivo. *Am J Physiol Endocrinol Metab.* 2012;302(12):E1569-75.
29. **Zhang L, Baker G, Janus D, Paddon CA, Fuhrer D, and Ludgate M.** Biological effects of thyrotropin receptor activation on human orbital preadipocytes. *Invest Ophthalmol Vis Sci.* 2006;47(12):5197-203.
30. Fraser CG. *Biological Variation: From Principles to Practice.* Washington, DC: AACCC Press; 2001.
31. **Wiersinga WM, and Chopra IJ.** Radioimmunoassay of thyroxine (T<sub>4</sub>), 3,5,3'-triiodothyronine (T<sub>3</sub>), 3,3',5'-triiodothyronine (reverse T<sub>3</sub>, rT<sub>3</sub>), and 3,3'-diiodothyronine (T<sub>2</sub>). *Methods Enzymol.* 1982;84(272-303).
32. **Simonson DC, and DeFronzo RA.** Indirect calorimetry: methodological and interpretative problems. *Am J Physiol.* 1990;258(3 Pt 1):E399-412.
33. **Kyle UG, Bosaeus I, De Lorenzo AD, Deurenberg P, Elia M, Gomez JM, Heitmann BL, Kent-Smith L, Melchior JC, Pirlich M, Scharfetter H, Schols AM, Pichard C, and Composition of the EWG.** Bioelectrical impedance analysis--part I: review of principles and methods. *Clin Nutr.* 2004;23(5):1226-43.
34. **Byrne C, and Lim CL.** The ingestible telemetric body core temperature sensor: a review of validity and exercise applications. *Br J Sports Med.* 2007;41(3):126-33.
35. **Bianco AC, Anderson G, Forrest D, Galton VA, Gereben B, Kim BW, Kopp PA, Liao XH, Obregon MJ, Peeters RP, Refetoff S, Sharlin DS, Simonides WS, Weiss RE, and Williams GR.** American thyroid association guide to investigating thyroid hormone economy and action in rodent and cell models. *Thyroid.* 2014;24(1):88-168.
36. **Nagayama Y, Kaufman KD, Seto P, and Rapoport B.** Molecular cloning, sequence and functional expression of the cDNA for the human thyrotropin receptor. *Biochem Biophys Res Commun.* 1989;165(3):1184-90.
37. **Veldhuis JD, Keenan DM, and Pincus SM.** Motivations and methods for analyzing pulsatile hormone secretion. *Endocr Rev.* 2008;29(7):823-64.
38. **Pincus SM.** Irregularity and asynchrony in biologic network signals. *Methods Enzymol.* 2000;321(149-82).





# CHAPTER 5

## Familial Longevity is Associated with Higher TSH secretion and Strong TSH-fT3 Relationship

Jansen SW, Roelfsema F, van der Spoel E, Akintola AA, Postmus I, Ballieux B, Slagboom PE, Cobbaert C, van der Grond J, Westendorp RG, Pijl H, van Heemst D.  
*J Clin Endocrinol Metab.* 2015 Oct;100(10):3806-13. doi: 10.1210/jc.2015-2624.



## ABSTRACT

*Context.* Longevity is associated with changes in circulating levels of thyroid hormone (TH) and/or thyroid stimulating hormone (TSH) in animals and humans, but underlying mechanisms remain elusive.

*Objective.* We explored in 38 offspring of nonagenarian participants from the Leiden Longevity Study, who are enriched for longevity and in their partners, ultradian and circadian rhythmicity of TSH, temporal relationship and feedback and forward interplay between TSH and TH.

*Methods.* We collected blood samples every 10 min for 24-h TSH and TH profiles. We used deconvolution analysis to estimate basal (non-pulsatile), pulsatile and other secretion parameters to characterize ultradian rhythmicity and locally weighted polynomial regression of TSH to assess circadian rhythmicity. Cross-correlation analysis was employed to investigate the temporal relationship between TSH and TH and cross- approximate entropy (ApEn) to assess feedback and forward interplay between TSH and TH.

*Results.* Compared to partners, offspring displayed higher mean (95% - confidence interval (CI)) basal TSH secretion (34.3 (27.2-43.1) mU/L/24 h versus 18.5 (14.4-23.7) mU/L/24 h,  $P = .001$ ), but no differences in ultradian or circadian properties of TSH. Temporal relationship between TSH and fT3 at zero delay was higher in offspring ( $0.48 \pm 0.2$ ) compared to partners ( $0.26 \pm 0.4$ ) ( $P = .05$ ), but feedback and forward interplay between TSH and TH did not differ.

*Conclusions.* Familial longevity is associated with increased basal TSH secretion and a strong temporal relationship between TSH and fT3, but not with differences in ultradian or circadian TSH rhythmicity or feedback and forward interplay between TSH and TH.



## INTRODUCTION

Thyroid stimulating hormone (TSH) secretion is regulated by the stimulatory hormone thyrotropin-releasing hormone (TRH) and inhibitory hypothalamic factors, including dopamine and somatostatin, while secreted thyroid hormones inhibit TRH and TSH secretion via a negative feedback loop. TSH stimulates the thyroid gland to synthesize and secrete thyroid hormones (TH) in the circulation. One hundred percent of circulating thyroxine (T4) is secreted by the thyroid gland, however only 20% of triiodothyronine (T3) is derived from this source(1). In peripheral tissues T4 is metabolized to T3 by removal of an iodide atom by deiodinating enzymes, or to inactive reverse T3 (rT3) and further degradation products. TSH has a distinct circadian rhythm with its maximum between 02.00h and 04.00h and its nadir between 16.00h and 20.00h. Recent data indicate that free T3 (fT3) also has a circadian rhythm following that of TSH with a lagtime of 90 minutes(1). In humans, TSH secretion is pulsatile which accounts for the circadian variation in the TSH levels(2), because the frequency and amplitude of pulsations increase during the evening and reach a peak at the sleep onset(3). It has been proposed that pulses are generated by a TSH 'pulse generator', however, anatomical and functional details of the 'pulse generator' are unknown(4). Nevertheless, this system is known to be robust and stable under different conditions including hypothyroidism(5).

Longevity has been associated with changes in circulating levels of free T4 (fT4), fT3 and/or TSH in animal models and in humans(6). Centenarians had significantly higher TSH levels as did their offspring when compared to controls(7). In the Leiden Longevity Study (LLS), we observed among nonagenarians that those from families with the most prominent excess survival, had higher serum TSH levels and lower fT3 and fT4 levels(8). Moreover, offspring of nonagenarian LLS participants ("offspring") displayed higher TSH levels than age-matched partner controls ("partners") and slightly lower fT3 in a fasted morning sample(6). When TSH and THs were frequently measured over a 24-h period, TSH concentration was on average 0.8 mU/L higher on every time point in offspring compared to partners, but there were no differences in TH(9). Underlying mechanisms for the increased TSH secretion and the discrepancy between increased TSH secretion but comparable circulating TH levels are unknown. Previously, adverse conditions including aging have been associated with changes in the ultradian and circadian rhythmicity of TSH(10, 11). However, no research has been performed on the ultradian and circadian rhythmicity of TSH or on the discrepancy between increased TSH secretion but unchanged circulatory TH levels in relation with familial longevity.

We aimed to explore in offspring of nonagenarian LLS participants who had at least sibling who was long-lived as well, and who are therefore enriched for familial longevity and in the offspring's partners (i) the ultradian rhythmicity of TSH (ii) the

circadian rhythmicity of TSH, (iii) the temporal relationship between TSH and TH and, (iv) the feedback and forward interplay between TSH and TH.

## METHODS

### Study population

As previously described in more detail(12), the Leiden Longevity Study (LLS) is a family based study consisting of 421 families with at least two long-lived Caucasian siblings fulfilling the age criteria (women aged  $\geq 91$  yr and males aged  $\geq 89$  yr), without any selection on demographics or health. In the current study we investigated 20 offspring of nonagenarian LLS participants (offspring) together with 18 partners who did not have parents fulfilling the LLS inclusion criteria and with whom the offspring share their life serving as a matched control group (partners). All participants were middle-aged (55-78 years) and had a stable body mass index (BMI) between 19-33 kg/m<sup>2</sup> (weight changes  $\leq 5$  kg within the last 3 months) and women did not use estrogen replacement. Participants were excluded if they had significant chronic renal, hepatic or endocrine disease including thyroid disorders and diabetes mellitus, or if they used medication known to influence lipolysis, thyroid function, glucose metabolism, GH/IGF-1 secretion or any other hormonal axis. To be able to safely perform the 24-h blood sampling, participants were excluded based on presence of anaemia (haemoglobin  $< 7.1$  mmol/L), blood donation within the last two months, recent trans-meridian flights, smoking addiction, consumption of more than 21 units of alcohol per week or extreme diet therapies. In the Netherlands, one unit of an alcoholic beverage is defined as a standard drink containing 9.9 g of ethanol. Based on information obtained via telephone screening, partners with one or more parents fulfilling the LLS inclusion criteria were also excluded. The current study is part of the Switchbox Leiden Study protocol P11.116, which was approved by the Medical Ethical Committee of the Leiden University Medical Centre and was performed according to the Helsinki declaration. All participants gave written informed consent for participation.

### Clinical protocol

The study commenced at 08.00 h with the intravenous insertion of a catheter in the forearm of the non-dominant hand. Blood sampling started at 09.00 h and blood was withdrawn every 10 minutes for 24 h. All participants received standardized feeding at three fixed times during the day (between 09.00 h-10.00 h, 12.00 h - 13.00 h and 18.00 h -19.00 h), each consisting of 600 kcal Nutridrink (Nutricia Advanced Medical Nutrition, Zoetermeer, The Netherlands). Lights were switched off between 23.00 h and 08.00 h. No naps were allowed during the day and ambulation was limited to the bathroom only. Full details on the 24-h blood sampling procedure are described elsewhere(13).

## Assays and Assay performance

Measurements were performed at the department of clinical chemistry and laboratory medicine (AKCL) of Leiden University Medical Center, which is accredited according to CCKL (National Coordination Committee for Quality Assurance for Health Care Laboratories in The Netherlands) using fully automated equipment and diagnostics from Roche Diagnostics and Siemens Healthcare diagnostics. TSH and TH were measured in serum samples by ElectroChemo Luminescence Immunoassay (ECLIA) using a Modular E170 Immunoanalyser (Roche Diagnostics cat. nrs.: TSH 11731459 122, FT4 gen II 06437281 190, FT3 03051986 190). Antithyroid peroxidase antibodies (anti-TPO Ab) were measured using an Immulite 2000 Xpi Immunoassay system (cat nr. Anti-TPO Ab L2KTO2). The TSH method has been standardized against the 2nd IRP WHO Reference Standard 80/558. The limits of detection were respectively 0.005 mU/L for TSH, 0.3 pmol/L for fT4, 1 pg/mL for fT3 and 5.0 IU/mL for anti-TPO Ab. For each participant, all samples from one time series were measured within the same lot number and in the same batch. For this study, the precision and quality of all assayed analytes met or surpassed the level of desirable quality specifications(14). For TSH, fT4 and fT3 Randox controls (cat. nrs/: IA 3109 and IA 3111) were used to determine the coefficients of variation (CVs). The CV ranged in our study between 1.41%-4.16% for TSH, 2.41%-3.49% for fT4, 2.16%-2.91% for fT3, and between 7%-9% for anti-TPO Ab. In our laboratory the reference values for TSH are 0.3-4.8mU/L, for fT4 10-24 pmol/L, for fT3 3-8 pmol/L and for anti-TPO Ab <35 IU/mL.

## Deconvolution analyses

The TSH hormone concentration time series were analyzed using a validated deconvolution method(15), with an automated Matlab program (the Mathworks, Inc., Natick, MA). The first step was to detrend the data and normalize concentrations to the unit interval (0,1). Thereafter, successive potential pulse-time sets, each containing one fewer burst, were created by a smoothing process. Lastly a maximum-likelihood expectation deconvolution method estimated all secretion and elimination rates simultaneously for each candidate pulse-time set. The outcome parameters of main interest are basal and pulsatile secretion, the sum of both (the total secretion), pulse frequency (number of pulses per 24 h), mean pulse mass, and the regularity of the burst intervals (Weibull gamma).

## Circadian Rhythmicity

We derived circadian parameters from locally weighted polynomial regression (LOESS) analysis, developed by Cleveland and Devlin(16). The software program Matlab (the Mathworks, Inc., Natick, MA) was used to compute the LOESS-fitting (with span = 0.2). We defined the acrophase of TSH as the time point where TSH reaches its highest point (maximum) in the early phase of the night. The nadir of TSH

was defined as the lowest point (minimum) in the evening after which the nocturnal surge of TSH starts. The circadian timing refers to the clock time of the nadir. The amplitude was calculated as the difference between the minimum and the maximum TSH levels in the early phase of the night.

### **Cross-correlation**

Cross-correlation was used to quantitate the temporal relationship between pairs of hormones (TSH - fT4 and TSH - fT3). Cross-correlation analysis assesses the strength between two signals from a hormone pair for all possible time shifts.

### **Cross-Approximate entropy (ApEn)**

Cross-ApEn is a bivariate, scale- and model-independent two-variable regularity statistic used to quantitate the relative pattern synchrony of coupled hormone series(17). With high sensitivity and specificity cross-ApEn of fT4-TSH reflects changes in the feedback synchrony and cross-ApEn of TSH-fT4 reflects changes in the feedforward synchrony(17, 18).

### **Statistical analysis**

Chi square test and independent t-test were used to describe differences between offspring and partners regarding sex, age, age of the parents, body composition, medical history, medication, lifestyle, and mean 24-h parameters of TSH and TH. All other analyses were performed using linear regression adjusted for age, sex and BMI to investigate differences between offspring and partners, unless otherwise indicated. All the data are presented as geometric means with 95% -confidence intervals (CI). Logarithmic transformation of data that were not normally distributed was used to decrease the variation.

For all above-mentioned analyses, SPSS for Windows, version 20 (SPSS, Chicago, IL) was used. Graphs were made using GraphPad Prism version 5 (GraphPad, San Diego, CA).  $P \leq 0.05$  was considered statistically significant.

## **RESULTS**

### **Group characteristics**

Study characteristics of offspring and partners are presented in Table 1. The parents of the offspring were older than those of the partners, a difference which was significant for the mothers ( $P = 0.001$ ). Offspring and partners were of similar age and had comparable body composition. No differences in disease history and medication use were observed between the groups. There was no difference in mean (95% CI) fasted serum leptin levels between offspring and partners adjusted for age,

sex and BMI (10.3 (8.1- 13.1)  $\mu\text{g/L}$  versus 10.4 (8.0-13.3)  $\mu\text{g/L}$ ,  $P = 0.99$ ). Significantly increased mean 24-h TSH levels, but no differences in mean 24-h fT4 and fT3 levels were found in the offspring compared to partners.

**Table 1** Group Characteristics of 20 Offspring From Nonagenarian LLS Participants and 18 Partners Thereof.

	Offspring n=20	Partners n=18	P-value
Demographics			
Male n (%)	10 (50.0)	10 (55.6)	0.73
Age (years)	65.6 (5.4)	64.6 (4.9)	0.52
BMI (kg/m <sup>2</sup> )	25.4 (4.0)	25.5 (3.9)	0.91
Fat mass (kg)*	23.5 (7.1)	23.7 (7.8)	0.93
Fat free mass (kg)*	51.3 (12.0)	52.5 (11.4)	0.75
Parental characteristics			
Age mother (years)	92.4 (7.9)	78.6 (13.9)	0.001
Age father (years)	82.5 (18.9)	76.8 (9.2)	0.25
Medical history			
Cardiovascular disease n (%)	0 (0)	1 (5.5)	0.29
Medication			
Statins n (%)	0 (0)	1 (5.6)	0.29
Anti-hypertensive n (%)	3 (15.0)	2 (11.1)	0.72
Lifestyle			
Smoking current n (%)	0 (0)	1 (5.6)	0.29
Alcohol > 21 units/week n (%)	1 (5.0)	2 (11.1)	0.49
Thyroid parameters			
Mean 24-h TSH (mU/L)	2.4 (1.2)	1.5 (0.6)	0.006
Mean 24-h fT4 (pmol/L)	14.3 (2.0)	14.3 (2.0)	0.97
Mean 24-h fT3 (pmol/L)	4.0 (0.4)	3.9 (0.3)	0.52

Unless indicated otherwise, data are presented as mean (standard deviation).

\* Data were not available for one male partner due to technical problems.

### Ultradian rhythmicity of TSH secretion

The results of the deconvolution analysis are displayed in Table 2. Offspring had significantly higher mean basal TSH secretion (95% CI) compared to partners (34.3 (27.2-43.1) mU/L/24 h versus 18.5 (14.4-23.7) mU/L/24 h,  $P = 0.001$ ), while pulsatile secretion was not significantly different between groups (Table 2). No differences

were found in the number of pulses, mean pulse mass or the time that the pulse reaches its maximum during day or night (mode) between offspring and partners. In addition, no differences were found between offspring and partners in pulse frequency ( $\lambda$ ) or regularity of the pulses ( $\gamma$ ) and in the fast or slow TSH half-life between the groups (Table 2).

**Table 2** TSH Secretion Parameters in 20 Offspring From Nonagenarian LLS Participants and 18 Partners Thereof.

	Offspring n=20	Partners n=18	p-value
Basal secretion (mU/L/24 h)	34.3 (27.2-43.1)	18.5 (14.4-23.7)	0.001
Pulsatile secretion (mU/L/24 h)	19.0 (14.0-25.6)	14.9 (10.8-20.6)	0.28
Total secretion (mU/L/24 h)	54.9 (43.5-69.2)	34.2 (26.6-44.0)	0.008
Pulse number (per 24 h)	17.3 (15.5-19.3)	17.7 (15.7-19.9)	0.79
Mean pulse mass (mU/L)	1.1 (0.8-1.5)	0.8 (0.6-1.1)	0.22
Fast half life (minutes)	21.7 (18.5-25.4)	21.0 (17.6-24.9)	0.77
Slow half life (minutes)	74.2 (66.3-83.0)	81.9 (72.5-92.5)	0.24
Mode day (minutes)	11.5 (8.1-14.9)	14.4 (10.8-18.1)	0.23
Mode night (minutes)	9.2 (6.8-12.5)	12.1 (8.7-16.9)	0.19
Lambda (unit less)	16.2 (14.5-18.1)	16.3 (14.5-18.4)	0.91
Gamma (unit less)	2.1 (1.9-2.4)	2.0 (1.8-2.3)	0.62

Data are shown as mean with 95%-confidence interval. Differences between the groups were evaluated with linear mixed model adjusted for age, sex and body mass index.

### Circadian rhythmicity of TSH concentration

Representative 24-h TSH profiles of one male offspring and one male partner are displayed in Fig. 1. Maximum TSH as well as the nadir were both significantly higher in the offspring compared to partners (Table 3), while no significant difference was observed in the amplitude between groups. Circadian timing and the acrophase were also not different between offspring and partners (Table 3).

Twenty-four hour serum TSH concentration profile with mean 24-h TSH represented by the dotted line in A. One male offspring whose mean 24-h TSH is 2.30 mU/L B. One male partner whose mean 24 hour TSH is 1.03 mU/L.

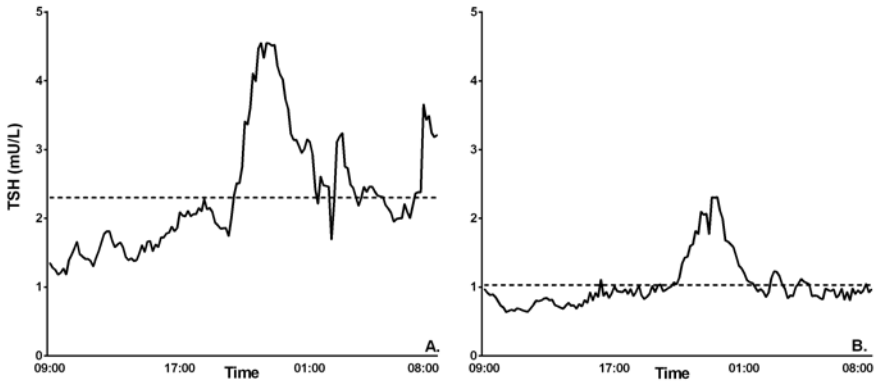

**Figure 1** Representative 24-h TSH profiles of one male offspring of nonagenarian LLS participants and one male partner.

**Table 3** Circadian Rhythmicity of TSH in 20 Offspring From Nonagenarian LLS Participants and 18 Partners Thereof.

	Offspring n=20	Partners n=18*	p-value
Maximum (mU/L)	3.1 (2.4-4.0)	2.1 (1.6-2.8)	0.05
Nadir (mU/L)	1.8 (1.4-2.2)	1.1 (0.8-1.4)	0.01
Acrophase time (minutes)	23:40 (23:10-00:20)	23:40 (23:00-00:20)	0.91
Circadian timing (minutes)	20:20 (19:30-21:00)	20:00 (19:20-20:50)	0.64
Amplitude (mU/L)	1.2 (0.9-1.7)	1.0 (0.7-1.4)	0.30

Data are shown as mean with 95%-confidence interval. Differences between the groups were evaluated with linear mixed model adjusted for age, sex and body mass index.

\*Data for 1 female partner was excluded due to the absence of a pattern

### Temporal relationship of TSH and TH

The cross correlation of TSH and fT4 did not show a strong temporal relationship in both groups. The strongest (mean  $\pm$  SD) temporal relationship ( $0.21 \pm 0.3$ ,  $P = 0.006$ ) in the offspring was at time delay of zero and the strongest temporal relationship in the partners ( $0.18 \pm 0.2$ ,  $P = 0.004$ ) was at time advance of 2 hours.

There was a strong temporal relationship (mean  $\pm$  SD) in our study population between TSH and fT3 ( $0.38 \pm 0.3$ ,  $P < 0.001$ ) at zero delay. The cross-correlation was stronger in the offspring ( $0.48 \pm 0.2$ ) compared to partners ( $0.26 \pm 0.4$ ) ( $P = 0.05$ ) (Fig. 2A). However, in the partner group the strongest temporal relationship was

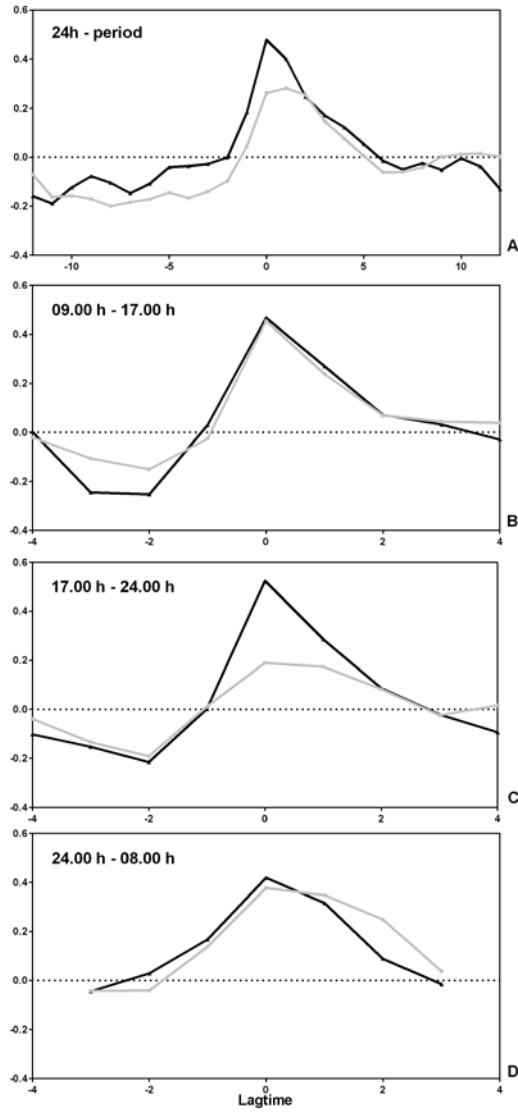

**Figure 2** Temporal relationship between TSH and fT3 in 20 offspring of nonagenarian LLS participants and 18 partners thereof.

Temporal relationship of TSH and fT3 in offspring (black line) and partners (grey line) over a 24 h period (A), between 09.00 h – 17.00 h (B), 17.00 h – 24.00 h (C) and 24.00 h – 08.00 h (D). In the graphs, the y-axis displays the correlation between the TSH and fT3 profiles and the x-axis the different periods of delay (negative number) or advance (positive number). If TSH and fT3 were both identical in profile and timing, there would be a peak correlation of one at zero delay.



found at time advance of one hour ( $0.28 \pm 0.4$ ,  $P = 0.01$ ). Next, we explored the temporal relationship of TSH and fT3 during the day (Fig. 2B), during the nocturnal surge (Figure 2C) and during the night (Fig. 2D). No differences between offspring and partners were found in the temporal relationship during the day or night. However during the nocturnal surge, the temporal relationship between TSH and fT3 was significantly stronger in offspring than in partners ( $0.52 \pm 0.4$  versus  $0.19 \pm 0.5$ ,  $P = 0.04$ ).

There was no evidence of relationships between strength of rhythmicity and age or sex. There was a trend correlation between age of the mother and the strongest temporal relationship (Pearson correlation 0.29,  $P = 0.07$ ), but not with the age of the father.

### TSH - TH interaction

The feedforward pattern synchrony of TSH on fT4 (cross ApEn TSH fT4) and feedback pattern synchrony of fT4 on TSH (cross ApEn fT4 TSH) as well as feedforward synchrony of TSH on fT3 (cross ApEn TSH fT3) and feedback synchrony of fT3 on TSH (cross ApEn fT3 TSH) were also not significantly different between offspring and partners (Fig. 3).

### Restricted analyses

Medical screening was performed by a medical doctor and included assessment of history and presence of thyroid disease. Retrospectively, we measured anti-TPO antibodies and found that three participants (all offspring) had increased anti-TPO antibodies ( $> 35$  IU/mL) and one participant (offspring) had missing values for anti-TPO antibodies. Therefore, additional restricted analyses were performed. Exclusion of the four participants having elevated or missing anti-TPO antibody values did not materially change the results. Compared to partners, offspring had significantly ( $P = 0.01$ ) higher mean basal TSH secretion ( $33.0$  ( $26.4$ - $39.6$ ) mU/L/24 h versus  $20.8$  ( $14.5$ - $27.1$ ) mU/L/24 h) but similar ultradian or circadian rhythmicity of TSH (data not shown). Compared to partners, offspring tended to have stronger mean  $\pm$  SD cross-correlation between TSH and fT3 ( $0.47 \pm 0.24$  versus  $0.26 \pm 0.38$ ,  $P = 0.065$ ), while the feedback and forward interplay between TSH and TH were similar between groups (data not shown).

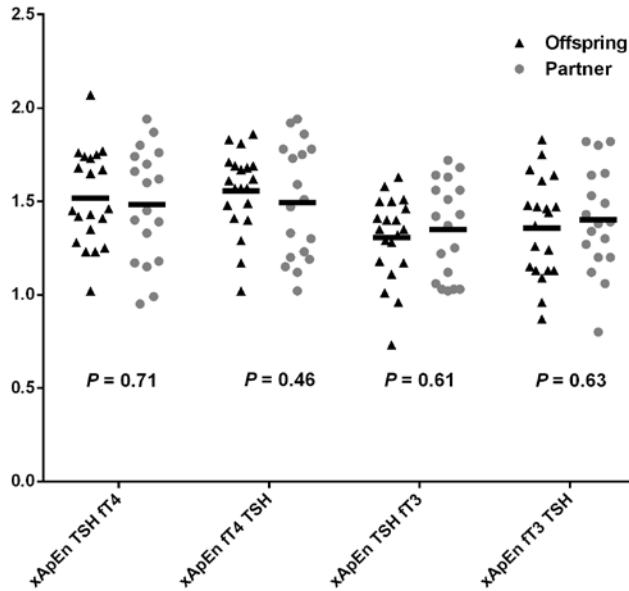

**Figure 3** Cross-ApEn of TSH and thyroid hormones in 20 offspring of nonagenarian LLS participants and 18 partners thereof.

The black triangles represent the offspring (n=20) and the grey circles the partners (n=18). The black bar represents the geometric mean.

## DISCUSSION

In this study, we investigated if human familial longevity is associated with changes in ultradian or circadian rhythmicity of TSH and if the temporal relationship between TSH and TH or the feedback and feedforward synchrony between TSH and TH were changed. The main findings in offspring enriched for familial longevity compared with the partners are as follows; 1) TSH secretion was characterized by higher basal but not pulsatile secretion; 2) the circadian rhythm of TSH was characterized by a significantly higher maximum and minimum, but no differences in amplitude or circadian phase; 3) the temporal relationship was stronger between TSH - fT3, but not for TSH - fT4; 4) no differences were found in feedforward or feedback synchrony of TSH and TH.

Like other pituitary hormones, TSH secretion is partially pulsatile and non-pulsatile (basal), although relative proportions vary between the hormone systems(5, 19). The basic mechanisms involved in the generation of TSH pulses are unknown. Infusions

with TRH do not change the intrinsic pulse frequency, but increase pulse amplitude(20). In this study, TSH pulse frequency, as well as the pulse mass were similar between offspring and partners. This finding suggests that the increased TSH secretion is not mediated by enhanced hypothalamic TRH release. In line with this view, we previously found that the approximate entropy (ApEn) of TSH was unchanged(9), which should be increased under amplified TRH drive, as observed in primary hypothyroidism(21).

TSH secretion is also under restraint of inhibitory hormones and neurotransmitters. Somatostatin(22) and dopamine directly inhibit the thyrotrophs via specific receptors, while leptin(23) acts indirectly by diminishing the TRH signal(24). Cortisol also has a physiological important inhibitory effect on TSH secretion(21). Since there was no difference between offspring and partners in serum leptin levels, and body weight and body composition were similar in offspring and partners, a role of leptin in causing the TSH difference is unlikely. With respect to cortisol, detailed analysis of ACTH-cortisol secretion in this cohort did not reveal major differences between the two groups, indicating that the adrenal gland is not likely involved in the increased TSH in longevity(25). Another possibility for increased basal TSH secretion is diminished central dopaminergic tone. Interestingly, TSH profiles in obese women closely resemble those of the offspring participants, by increased basal secretion, but unchanged pulse frequency, secretory regularity (ApEn) and serum fT4 concentration(24). It may seem counter-intuitive that both longevity, which is associated with superior metabolic health(26), and obesity, which is associated with reduced metabolic health, are associated with increased TSH secretion. However, other examples exist of common features that are observed both in long-lived and short-lived models. For example, it was shown that the transcription profile of mice that are short-lived due to mutations in DNA repair resembled that of long-lived mice, suggesting that in short-lived mice protective transcriptional programs are activated by the accumulation of damage that are constitutively active in long-lived mice(27). Theoretically, it is possible that increased TSH secretion represents a constitutive feature of familial longevity, while in obesity it represents a response to overweight. In rats, overconsumption of palatable food gradually decreased responsiveness of dopaminergic brain circuits(28). Administration of low dose bromocriptine, a dopamine agonist, normalized TSH secretion, while fT4 levels remained unchanged in obese pre-menopausal women(29). In addition, we had no clinical evidence for iodine deficiency. Another less likely mechanism may be impaired production of iodine, caused by reduced iodine intake or impaired storage/processing. Iodine is needed for the production of thyroid hormones, and during shortage of iodine, the euthyroid state can be maintained through adaptation to preferential synthesis and secretion of T3 over T4(30, 31). However, since most offspring and partners have shared the previous decades of their lives with each other and had no medical history of goiter, reduced iodine levels because of reduced intake or other underlying mechanisms is not very likely.

The circadian properties of TSH, including the acrophase and circadian timing, were not different between offspring and partners. Generally, these properties of the HPT-axis are very robust in healthy participants(32), unless the sleep-wake cycle is manipulated(5), or in diseases including depression(33), Alzheimer's disease(10) and metabolic decompensation in diabetes mellitus type I and II(34).

Remarkably, TH concentrations were similar in offspring and partners despite a 60% higher TSH secretion. This observation may be the result of either diminished biological activity of TSH, increased peripheral deiodinase activity or decreased sensitivity of the thyroid gland to TSH. Recently, we found that the biological TSH activity was not different between groups(9). In this study we found that the temporal relationship between TSH and fT3 was significantly stronger in the offspring, mainly caused by a significantly increased cross correlation during the nocturnal surge. FT3 is predominantly produced by peripheral conversion while a small amount is secreted by the thyroid gland. In a previous study we did not find differences between offspring and partners in estimates of peripheral conversion(9), therefore it seems likely that changes in fT3 relate to TSH stimulation of thyroid hormone release. Since the fT3 and total T3 levels were comparable between offspring and partners, all together this may be indicative for decreased sensitivity of the thyroid gland to TSH. We found in both offspring and partners a strong pattern synchrony between diurnal pulsatile TSH and TH concentrations and vice versa. This reflects the known stimulating effect of TSH on the release of TH and conversely its negative feedback mechanism. However, no differences were found between offspring and partners in pattern synchrony between TSH – TH and TH – TSH, indicating no loss of coupling between TSH and TH and vice versa.

The strength of our study is that we measured TSH every 10 min and TH hourly over a 24-h period and that we were therefore able to study the HPT-axis in detail using state of the art mathematical techniques. From a methodological viewpoint, the potentially confounding effect of intra-individual variation and reagent batch variation were abolished as per participant all analyses from all time points were run using the same reagent and calibrator batches. Moreover, we performed our study in a special cohort, in which we are able to study familial human longevity. One of the limitations of this study was that not every offspring of a nonagenarian LLS participant is enriched for longevity, which may have diluted potential differences.

In population-based studies, mean TSH levels tend to increase with age(35-38), although some studies suggest that 24-h TSH levels are decreased in aging men(39). In other studies, in participants aged up to 85 years(40) or even 90 years(6), higher levels of TSH have been associated with lower mortality. Also long-lived siblings and their offspring were shown to have higher levels of TSH compared to controls, although underlying mechanisms remained elusive. In this study, evaluating 24-h hypothalamic pituitary thyroid axis activity in depth, we found that familial longevity is

associated with increased basal TSH secretion and a stronger temporal relationship between TSH and fT3 especially during the nocturnal TSH surge. We did not detect differences in ultradian or circadian rhythmicity of TSH release between offspring enriched for longevity and partners, or in the pattern synchrony between TSH and TH. Underlying mechanisms of the increased basal TSH secretion may include an enhanced resistance of the thyroid gland to TSH and/or diminished central dopaminergic tonus. Challenge experiments using TSH, TH or dopamine agonist are needed to mechanistically unravel these mechanisms. Further studies are also needed to investigate the pleiotropic effects of increased basal TSH secretion and its role in human healthy longevity.

## REFERENCES

1. **Russell W, Harrison RF, Smith N, Darzy K, Shalet S, Weetman AP, and Ross RJ.** Free triiodothyronine has a distinct circadian rhythm that is delayed but parallels thyrotropin levels. *J Clin Endocrinol Metab.* 2008;93(6):2300-6.
2. **Brabant G, Prank K, Ranft U, Schuermeyer T, Wagner TO, Hauser H, Kummer B, Feistner H, Hesch RD, and von zur Muhlen A.** Physiological regulation of circadian and pulsatile thyrotropin secretion in normal man and woman. *J Clin Endocrinol Metab.* 1990;70(2):403-9.
3. **Behrends J, Prank K, Dogu E, and Brabant G.** Central nervous system control of thyrotropin secretion during sleep and wakefulness. *Horm Res.* 1998;49(3-4):173-7.
4. **Samuels MH, Veldhuis J, and Ridgway EC.** Copulsatile release of thyrotropin and prolactin in normal and hypothyroid subjects. *Thyroid.* 1995;5(5):369-72.
5. **Roelfsema F, and Veldhuis JD.** Thyrotropin secretion patterns in health and disease. *Endocr Rev.* 2013;34(5):619-57.
6. **Bowers J, Terrier J, Clerget-Froidevaux MS, Gothie JD, Rozing MP, Westendorp RG, van Heemst D, and Demeneix BA.** Thyroid hormone signaling and homeostasis during aging. *Endocr Rev.* 2013;34(4):556-89.
7. **Atzmon G, Barzilai N, Surks MI, and Gabriely I.** Genetic predisposition to elevated serum thyrotropin is associated with exceptional longevity. *J Clin Endocrinol Metab.* 2009;94(12):4768-75.
8. **Rozing MP, Houwing-Duistermaat JJ, Slagboom PE, Beekman M, Frolich M, de Craen AJ, Westendorp RG, and van Heemst D.** Familial longevity is associated with decreased thyroid function. *J Clin Endocrinol Metab.* 2010;95(11):4979-84.
9. **Jansen SW, Akintola AA, Roelfsema F, van der Spoel E, Cobbaert CM, Ballieux BE, Egri P, Kvarta-Papp Z, Gereben B, Fekete C, Slagboom PE, van der Grond J, Demeneix BA, Pijl H, Westendorp RGJ, and van Heemst D.** Human longevity is characterised by high thyroid stimulating hormone secretion without altered energy metabolism. *Sci Rep.* 2015;5(
10. **Chen JM, Huang CQ, Ai M, and Kuang L.** Circadian rhythm of TSH levels in subjects with Alzheimer's disease (AD). *Aging Clin Exp Res.* 2013;25(2):153-7.
11. **Froy O.** Circadian rhythms, aging, and life span in mammals. *Physiology (Bethesda).* 2011;26(4):225-35.
12. **Westendorp RG, van Heemst D, Rozing MP, Frolich M, Mooijaart SP, Blauw GJ, Beekman M, Heijmans BT, de Craen AJ, Slagboom PE, and Leiden Longevity Study G.** Nonagenarian siblings and their offspring display lower risk of mortality and morbidity than sporadic nonagenarians: The Leiden Longevity Study. *J Am Geriatr Soc.* 2009;57(9):1634-7.
13. **Akintola AA, Jansen SW, Wilde RBP, Hultzer G, Rodenburg R, van Heemst D.** A simple and versatile method for frequent 24 h blood sample collection in healthy older adults. *MethodsX.* 2015(2):33-8.
14. **Fraser CG.** *Biological Variation: From Principles to Practice.* Washington, DC: AACCC Press; 2001.
15. **Keenan DM, Roelfsema F, Biermasz N, and Veldhuis JD.** Physiological control of pituitary hormone secretory-burst mass, frequency, and waveform: a statistical formulation and analysis. *Am J Physiol Regul Integr Comp Physiol.* 2003;285(3):R664-73.
16. **Devlin SCSJ.** Locally Weighted Regression: An Approach to Regression Analysis by Local Fitting. *Journal of the American Statistical Association.* 1988;83(403):596-610.
17. **Veldhuis JD, Straume M, Iranmanesh A, Mulligan T, Jaffe C, Barkan A, Johnson ML, and Pincus S.** Secretory process regularity monitors neuroendocrine feedback and feedforward signaling strength in humans. *Am J Physiol Regul Integr Comp Physiol.* 2001;280(3):R721-9.
18. **Veldhuis JD, Roelfsema F, Iranmanesh A, Carroll BJ, Keenan DM, and Pincus SM.** Basal, pulsatile, entropic (patterned), and spiky (staccato-like) properties of ACTH secretion: impact of age, gender, and body mass index. *J Clin Endocrinol Metab.* 2009;94(10):4045-52.
19. **Veldhuis JD, Keenan DM, and Pincus SM.** Motivations and methods for analyzing pulsatile hormone secretion. *Endocr Rev.* 2008;29(7):823-64.
20. **Samuels MH, Henry P, Luther M, and Ridgway EC.** Pulsatile TSH secretion during 48-hour continuous TRH infusions. *Thyroid.* 1993;3(3):201-6.
21. **Re RN, Kourides IA, Ridgway EC, Weintraub BD, and Maloof F.** The effect of glucocorticoid administration on human pituitary secretion of thyrotropin and prolactin. *J Clin Endocrinol Metab.* 1976;43(2):338-46.

22. **Arimura A, and Schally AV.** Increase in basal and thyrotropin-releasing hormone (TRH)-stimulated secretion of thyrotropin (TSH) by passive immunization with antiserum to somatostatin in rats. *Endocrinology.* 1976;98(4):1069-72.
23. **Casanueva FF, and Dieguez C.** Neuroendocrine regulation and actions of leptin. *Front Neuroendocrinol.* 1999;20(4):317-63.
24. **Kok P, Roelfsema F, Frolich M, Meinders AE, and Pijl H.** Spontaneous diurnal thyrotropin secretion is enhanced in proportion to circulating leptin in obese premenopausal women. *J Clin Endocrinol Metab.* 2005;90(11):6185-91.
25. **Steffy W, Jansen FR, Abimbola A, Akintola, Nicole Y. Oei, Christa M. Cobbaert, Bart E. Ballieux, Jeroen van der Grond, Rudi G. Westendorp, Hanno Pijl, Diana van Heemst.** Characterization of the Hypothalamic-Pituitary-Adrenal-Axis in Familial Longevity under Resting Conditions. *Plos One.* 2015.
26. **Rozing MP, Westendorp RG, de Craen AJ, Frolich M, de Goeij MC, Heijmans BT, Beekman M, Wijsman CA, Mooijaart SP, Blauw GJ, Slagboom PE, van Heemst D, and Leiden Longevity Study G.** Favorable glucose tolerance and lower prevalence of metabolic syndrome in offspring without diabetes mellitus of nonagenarian siblings: the Leiden longevity study. *J Am Geriatr Soc.* 2010;58(3):564-9.
27. **Schumacher B, van der Pluijm I, Moorhouse MJ, Kosteas T, Robinson AR, Suh Y, Breit TM, van Steeg H, Niedernhofer LJ, van Ijcken W, Bartke A, Spindler SR, Hoeijmakers JH, van der Horst GT, and Garinis GA.** Delayed and accelerated aging share common longevity assurance mechanisms. *PLoS Genet.* 2008;4(8):e1000161.
28. **Johnson PM, and Kenny PJ.** Dopamine D2 receptors in addiction-like reward dysfunction and compulsive eating in obese rats. *Nat Neurosci.* 2010;13(5):635-41.
29. **Kok P, Roelfsema F, Frolich M, van Pelt J, Meinders AE, and Pijl H.** Bromocriptine reduces augmented thyrotropin secretion in obese premenopausal women. *J Clin Endocrinol Metab.* 2009;94(4):1176-81.
30. **Fukuda H, Yasuda N, and Greer MA.** Changes in plasma thyrotrophin, thyroxine, and triiodothyronine after acute or chronic administration of iodide to iodine-deficient rats. *Endocrinology.* 1975;97(5):1196-204.
31. **Fukuda H, Yasuda N, Greer MA, Kutas M, and Greer SE.** Changes in plasma thyroxine, triiodothyronine, and TSH during adaptation to iodine deficiency in the rat. *Endocrinology.* 1975;97(2):307-14.
32. **Roelfsema F, Pereira AM, Veldhuis JD, Adriaanse R, Ender E, Fliers E, and Romijn JA.** Thyrotropin secretion profiles are not different in men and women. *J Clin Endocrinol Metab.* 2009;94(10):3964-7.
33. **Bartalena L, Placidi GF, Martino E, Falcone M, Pellegrini L, Dell'Osso L, Pacchiarotti A, and Pinchera A.** Nocturnal serum thyrotropin (TSH) surge and the TSH response to TSH-releasing hormone: dissociated behavior in untreated depressives. *J Clin Endocrinol Metab.* 1990;71(3):650-5.
34. **Bartalena L, Cossu E, Grasso L, Velluzzi F, Loviselli A, Cirillo R, and Martino E.** Relationship between nocturnal serum thyrotropin peak and metabolic control in diabetic patients. *J Clin Endocrinol Metab.* 1993;76(4):983-7.
35. **Kratzsch J, Fiedler GM, Leichtle A, Brugel M, Buchbinder S, Otto L, Sabri O, Matthes G, and Thiery J.** New reference intervals for thyrotropin and thyroid hormones based on National Academy of Clinical Biochemistry criteria and regular ultrasonography of the thyroid. *Clin Chem.* 2005;51(8):1480-6.
36. **Vadiveloo T, Donnan PT, Murphy MJ, and Leese GP.** Age- and gender-specific TSH reference intervals in people with no obvious thyroid disease in Tayside, Scotland: the Thyroid Epidemiology, Audit, and Research Study (TEARS). *J Clin Endocrinol Metab.* 2013;98(3):1147-53.
37. **Yoshihara A, Noh JY, Ohye H, Sato S, Sekiya K, Kosuga Y, Suzuki M, Matsumoto M, Kunii Y, Watanabe N, Mukasa K, Ito K, and Ito K.** Reference limits for serum thyrotropin in a Japanese population. *Endocr J.* 2011;58(7):585-8.
38. **Bremner AP, Feddema P, Leedman PJ, Brown SJ, Beilby JP, Lim EM, Wilson SG, O'Leary PC, and Walsh JP.** Age-related changes in thyroid function: a longitudinal study of a community-based cohort. *J Clin Endocrinol Metab.* 2012;97(5):1554-62.
39. **van Coevorden A, Laurent E, Decoster C, Kerkhofs M, Neve P, van Cauter E, and Mockel J.** Decreased basal and stimulated thyrotropin secretion in healthy elderly men. *J Clin Endocrinol Metab.* 1989;69(1):177-85.
40. **Gussekloot J, van Exel E, de Craen AJ, Meinders AE, Frolich M, and Westendorp RG.** Thyroid status, disability and cognitive function, and survival in old age. *JAMA.* 2004;292(21):2591-9.





# PART III

## Hypothalamic-pituitary-adrenal axis and longevity





# CHAPTER 6

## Familial longevity is marked by lower diurnal salivary cortisol levels: The Leiden Longevity Study

Noordam R, Jansen SW\*, Akintola AA\*, Oei NY, Maier AB, Pijl H, Slagboom PE, Westendorp RG, van der Grond J, de Craen AJ, van Heemst D.  
*PLoS One.* 2012;7(2):e31166. doi: 10.1371.

\*equal contribution of both authors



## ABSTRACT

**Background:** Reported findings are inconsistent whether hypothalamic-pituitary-adrenal (HPA) signaling becomes hyperactive with increasing age, resulting in increasing levels of cortisol. Our previous research strongly suggests that offspring from long-lived families are biologically younger. In this study we assessed whether these offspring have a lower HPA axis activity, as measured by lower levels of cortisol and higher cortisol feedback sensitivity.

**Methods:** Salivary cortisol levels were measured at four time points within the first hour upon awakening and at two time points in the evening in a cohort comprising 149 offspring and 154 partners from the Leiden Longevity Study. A dexamethasone suppression test was performed as a measure of cortisol feedback sensitivity. Age, gender and body mass index, smoking and disease history (type 2 diabetes and hypertension) were considered as possible confounding factors.

**Results:** Salivary cortisol secretion was lower in offspring compared to partners in the morning (Area Under the Curve = 15.6 versus 17.1 nmol/L, respectively;  $p = 0.048$ ) and in the evening (Area Under the Curve = 3.32 versus 3.82 nmol/L, respectively;  $p = 0.024$ ). Salivary cortisol levels were not different after dexamethasone (0.5 mg) suppression between offspring and partners (4.82 versus 5.26 nmol/L, respectively;  $p = 0.28$ ).

**Conclusion:** Offspring of nonagenarian siblings are marked by a lower HPA axis activity (reflected by lower diurnal salivary cortisol levels), but not by a difference in cortisol feedback sensitivity. Further in-depth studies aimed at characterizing the HPA axis in offspring and partners are needed.

## INTRODUCTION

Cortisol secretion is tightly regulated by the hippocampus and the hypothalamic-pituitary-adrenal (HPA) axis through a negative feedback mechanism (1). In the brain, binding of cortisol to high affinity mineralocorticoid receptors plays an important role in negative feedback control under basal conditions, while binding of cortisol to low affinity glucocorticoid receptors plays an important role in feedback control during stress. In healthy individuals, cortisol levels show a distinct rise directly after awakening, which reaches peak levels at 30 minutes and returns to baseline levels 60 minutes after awakening. Cortisol levels then gradually fall as the day progresses and reach a trough around midnight (2). The distinct rise in cortisol levels upon awakening (3) is considered as a response to awakening (this distinct pattern is therefore also known as the cortisol awakening response or CAR), which is superimposed on the ultradian rhythm during the circadian cycle (4). Because of its intra-individual stability, the cortisol awakening response is considered a trait measure for HPA axis activity (3).

Changes in HPA axis activity are associated with numerous pathophysiological conditions, for example persons under chronic stress or with depression have, on average, higher levels of cortisol (5, 6). In addition, the cortisol awakening response is blunted or even absent in subjects having hippocampal damage, diabetes and hypertension (7, 8). Higher evening cortisol levels (within normal physiological ranges) are associated with several clinical and physiological parameters, including a higher blood pressure and a more insulin resistant metabolic profile (9-11). However, (cross-sectional) studies yielded inconsistent results regarding the changes that occur in HPA axis activity with increasing age. In some studies an increase in the cortisol awakening response was observed with increasing age (12), while others showed an opposite (13) or unaffected association (14). Moreover, some studies showed an increase in cortisol levels in the evening with increasing age, while others showed no effect (12, 15). Additionally, research showed that the HPA axis becomes less resilient in response to stress and becomes less sensitive to the negative feedback signals of glucocorticoids with increasing age (16). In dogs, it was shown that hippocampal volume as well as the number of hippocampal mineralocorticoid receptors decrease with age (17). These anatomical and functional changes are indicative of a reduced inhibition of the HPA axis, resulting in an increase in cortisol secretion.

Since the aforementioned studies compare young and old subjects, results from these studies might be confounded by a difference in prevalence of age-related diseases and depression. In the Leiden Longevity Study we have previously shown

that middle aged offspring from long lived nonagenarian siblings seem biologically younger than their age and environmentally matched partners as reflected in a lower prevalence of age-related diseases (18), lower mortality (19), lower glucose levels (20), and higher insulin sensitivity (21, 22). If diurnal cortisol levels increase with age, we would expect lower cortisol levels in these subjects compared to controls. To test this hypothesis, three research aims were addressed. First, saliva cortisol levels within the first hour upon awakening were measured as an assessment of the cortisol awakening response. Second, evening cortisol levels were assessed as an estimation of the lowest cortisol levels during the day. And third, a dexamethasone suppression test was performed to assess the cortisol feedback sensitivity. Measurements were performed in a random subpopulation from the Leiden Longevity Study comprising of 149 offspring and 154 partners.

## MATERIALS AND METHODS

### Study design

The Leiden Longevity Study was designed to identify genetic and phenotypic markers related to longevity. A more detailed description of the recruitment strategy of the Leiden Longevity Study can be found elsewhere (23). In short, a total of 421 families were recruited consisting of long-lived Caucasian siblings together with their offspring and partners thereof. The selection was based on the presence of at least two long-lived siblings that were still alive and fulfilled the age criteria of 89 years in case of males and 91 years for females (19), irrespective of health conditions and demographics. Because proper controls at high age are lacking, the offspring from these nonagenarian siblings were asked to participate and serve as cases, as they have an increased propensity to reach an old age. The partners of the offspring were asked to participate in the study as environmental- and age-matched controls.

For the present study 388 subjects (194 offspring and 194 partners) were enrolled from the Leiden Longevity Study. Saliva cortisol data were incomplete (at least one missing cortisol measurement out of the seven measurements or at least one missing time point of saliva collection) or invalid in 84 subjects (45 offspring and 39 partners) and these subjects were therefore excluded from the analyses. One subject (partner) used oral corticosteroids at the time of the study and was thus excluded from the analyses as well. None of the participants used inhaled corticosteroids. In total, data from 149 offspring from 93 families and 154 controls (their partners) were used for analyses. *This study was approved by the Medical Ethical Committee of the Leiden University Medical Center and written informed consent was obtained from all participants.*

### Salivary cortisol samples

Subjects were asked to collect saliva samples at home on an average weekday. Instructions for saliva sampling were given both orally (by a research nurse) and written. In total, six saliva samples for cortisol determination were obtained at one day. Four samples were taken at different time points in the first hour after awakening (at awakening and at 30 min, 45 min and one hour after awakening). These four time points were used to assess the CAR. The other two samples were taken in the evening, namely at 10 pm and 11 pm, as an estimation of the lowest cortisol levels during the day. For analyses, we refer to these samples to be taken at day "0". After the last saliva sample (at 11 pm), subjects were asked to ingest one dexamethasone tablet (0.5 mg). At awakening the next day (day "1"), one additional saliva sample was taken for an estimation of the cortisol level after dexamethasone treatment.

### Salivary cortisol measurements

Measurements were performed using fully automatic equipment. Cortisol was measured using an Electrochemoluminescence Immunoassay (ECLIA) on the Modular E-170 Immunoanalyser (Roche Diagnostics, Mannheim, Germany). Coefficients of variance were below 5.7% in the morning and below 9.7% in the evening samples.

### Other variables

Additionally, weight and height were measured by research nurses at the study center. Information about current smoking habits was obtained using a questionnaire and information on disease history was obtained via the general practitioner and antidepressant drug use was obtained via the pharmacies.

### Statistical analyses

All data used for this study were normally distributed. The Area Under the Curve was calculated with respect to the ground ( $y = 0$ ; cortisol levels were zero) as a measure for cortisol secretion in the first hour after awakening and for the evening time points ( $AUC_g$ ) (24). To assess the increase in cortisol upon awakening during the CAR, we calculated the Area Under the Curve ( $AUC_c$ ) with respect to the level of cortisol at time point 0 (24). To account for differences in time interval between individuals, both  $AUC$ 's were divided by the time of saliva collection between the first and last time sample. As a measure of suppression by dexamethasone, the difference between the awakening salivary cortisol concentration on day 0 and the awakening salivary cortisol concentration after overnight dexamethasone treatment was calculated.

Analyses of the general characteristics were performed using student t test (continuous data) and chi square statistics (for categorical data). Analyses concerning the comparison between offspring and partners in salivary cortisol concentrations were performed using linear regression models. First, data are presented unadjusted

for possible confounding factors. Second, data are presented after adjustment for the possible confounding factors: age, gender, body mass index and current smoking habits. Third, an additional analysis was performed in which adjustment was made for the history of type 2 diabetes and hypertension. Fourth, analyses were additionally adjusted for the use of antidepressant drugs, as these were previously described to associate with cortisol levels. Correlation between morning and evening cortisol levels was calculated using Pearson chi square. The analysis concerning the dexamethasone suppression test was additionally adjusted for the cortisol salivary concentration at awakening at day 0 to account for possible differences observed at day 0 that might modify the results at day 1. In addition, an interaction term in the statistical model was used to assess whether the association between age and the  $AUC_g$  of the cortisol awakening response and cortisol levels in the evening, and the effectiveness of the dexamethasone tablet was similar in offspring and partners.

All statistical analyses were performed using SPSS for Windows (version 17.0, USA). In addition, analyses were adjusted for familial relationship using residual weight in SPSS. P-Values below 0.05 were considered statistically significant.

## RESULTS

### Population characteristics

Characteristics of the study population are presented in table 1. The offspring and partner groups were similar with regard to the percentage of females, age, body mass index and smoking habits. Offspring had a lower prevalence of type-2 diabetes compared to their partners, but were similar in the prevalence of the other diseases and the usage of antidepressant drugs.

### Salivary cortisol levels

A graphical presentation of the cortisol awakening response in offspring and partners is presented in figure 1A. The analyses were adjusted for age, gender, body mass index and current smoking habits. At all four time points mean salivary cortisol tended to be lower in offspring compared to their partners. A trend of lower salivary cortisol levels in offspring was present in both females and males (figure 1B en 1C).

To estimate the total cortisol secretion within the first hour on awakening, the AUC was calculated with respect to the ground as well as to the cortisol level on awakening. Results on total cortisol secretion on awakening are presented in table 2. After adjustment for the possible confounding factors, including gender, age, body mass index and current smoking, offspring had a nearly significant tendency toward a lower total cortisol secretion compared to their partners ( $AUC_g = 15.9$  vs  $17.4$  nmol/L, respectively;  $p = 0.051$ ). After additional adjustment for disease history (type 2



**Table 1** General characteristics of the study population

	Offspring (n = 149)	Partners (n = 154)	P-Value
<b>Demographics</b>			
Females, no.(%)	72 (48.3)	84 (54.5)	0.28
Age (years)	66.0 (5.9)	65.5 (7.2)	0.57
Body Mass Index (kg/m <sup>2</sup> )	26.4 (3.9)	26.7 (4.2)	0.50
Current smokers, no.(%)	17 (11.5)	20 (13.2)	0.66
<b>Disease History, no.(%)</b>			
Type 2 Diabetes	4 (2.7)	15 (9.7)	0.010
Hypertension	32 (21.5)	41 (26.6)	0.27
Myocardial Infarction	1 (0.7)	3 (1.9)	0.32
Stroke	2 (1.3)	4 (2.6)	0.44
Rheumatoid arthritis	2 (1.3)	1 (0.6)	0.56
COPD	8 (5.4)	6 (3.9)	0.57
Antidepressant drugs, no.(%)	6 (4.0)	7 (4.5)	0.82

Age and body mass index are presented as means with the standard deviation.

Abbreviation: COPD Chronic Obstructive Pulmonary Disease

diabetes and hypertension), the difference in  $AUC_g$  between offspring and partners persisted, and reached statistical significance ( $p = 0.048$ ). Additionally, adjusting for antidepressant drug use did not materially change the difference in morning  $AUC_g$  between offspring and partners. Restriction to couples comprising an offspring and partner did not materially change the difference either. Furthermore, the  $AUC_i$  with saliva cortisol concentration at awakening as a reference was not different between offspring and partners ( $p = 0.66$ ).

Evening salivary cortisol was lower in offspring compared to their partners (figure 2A), which was significant at 11 pm ( $p = 0.045$ ) and nearly significant at 10 pm ( $p = 0.078$ ). On calculating the Area Under the Curve on the two time points (as a measure of the average cortisol levels per hour in the evening; lower half of table 2), offspring had lower salivary cortisol levels compared to their partners (3.41 vs 3.89 nmol/L;  $p = 0.026$ ). The differences in evening  $AUC_g$  between offspring and partners were similar when the analysis was additionally adjusted for disease history as well as when antidepressant drug use was included as a potential confounding factor. The trend towards lower evening cortisol levels in offspring was similar in females and males (figure 2B and C). The difference between offspring and partners persisted when the analysis was restricted to a subsample comprising only couples of offspring and partners.

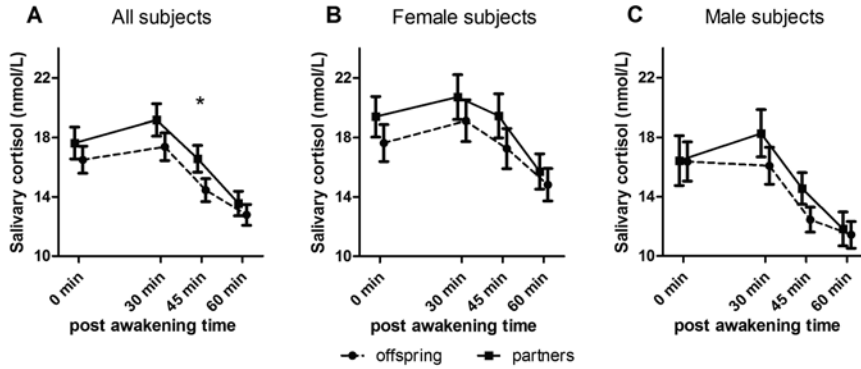

**Figure 1** Awakening response in offspring and partners

Cortisol Awakening Response (CAR). All three graphs present the mean cortisol level measured at the four time points. **A)** CAR in all offspring and partners. Analysis adjusted for age, gender, body mass index and current smoking habits. **B)** CAR in female offspring and partners. **C)** CAR in male offspring and partners. **B,C)** analysis adjusted for age, body mass index and current smoking habits. Data presented as means with the standard error of the mean (SEM). Statistical significance ( $p < 0.05$ ) denoted as an asterisk.

**Table 2** Salivary cortisol in offspring and partners

	Offspring (n = 149)	Partners (n = 154)	P - Value
<b>Morning (AUC<sub>g</sub>)</b>			
Model 1	15.4 (14.5 – 16.3)	16.7 (15.4 – 17.9)	0.12
Model 2	15.9 (14.5 – 17.2)	17.4 (15.9 – 18.9)	0.051
Model 3	15.6 (13.4 – 17.7)	17.1 (15.1 – 19.2)	0.048
<b>Evening (AUC<sub>g</sub>)</b>			
Model 1	3.21 (2.96 – 3.45)	3.68 (3.34 – 4.01)	0.027
Model 2	3.41 (3.05 – 3.76)	3.89 (3.47 – 4.30)	0.026
Model 3	3.32 (2.75 – 3.90)	3.82 (3.26 – 4.38)	0.024

Means presented as mean salivary cortisol in nmol/L with 95% confidence interval.  
 Model 1: Crude; Model 2: Adjusted for age, gender, body mass index and current smoking; Model 3: Adjusted for age, gender, body mass index, current smoking and disease history (Type 2 Diabetes and Hypertension). All analyses were adjusted for familial relationship. Data presented as means with 95% confidence interval. Abbreviation; AUC<sub>g</sub> Area Under the Curve with reference to the ground.

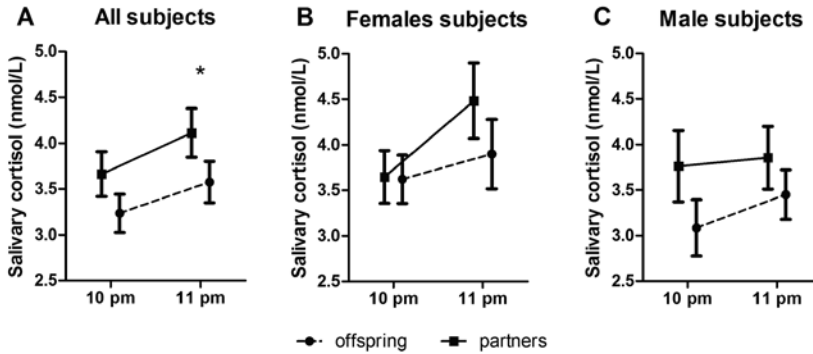

**Figure 2** Evening cortisol in offspring and partners

Evening cortisol. All three graphs present the mean cortisol level measured at the two time points. **A)** Evening cortisol in all offspring and partners. Analysis adjusted for age, gender, body mass index and current smoking habits. **B)** Evening cortisol in female offspring and partners. **C)** Evening cortisol in male offspring and partners. **B,C)** analysis adjusted for age, body mass index and current smoking habits. Data presented as means with the standard error of the mean (SEM). Statistical significance ( $p < 0.05$ ) denoted as an asterisk.

The AUC of the cortisol awakening response and the AUC of the evening cortisol were positively correlated to each other (Pearson Correlation,  $r = 0.25$ ,  $p = <0.001$ ). The association between the AUC of the cortisol awakening response and the AUC of the evening cortisol was similar for offspring and partners ( $p$  for interaction = 0.51, when adjusted for age, gender, body mass index, current smoking and disease history).

### Dexamethasone suppression test

Results of the overnight dexamethasone test are presented in table 3. After adjusting for possible confounding factors, awakening salivary cortisol levels after dexamethasone treatment were not different between offspring and partners (4.82 vs 5.26 nmol/L, respectively;  $p = 0.26$ ). Moreover, adjustment for the salivary cortisol concentration at awakening on day 0 did not materially change this analysis. Furthermore, the difference between salivary cortisol levels at awakening with and without dexamethasone, as a measure of effectiveness, was similar for offspring and partners (10.0 vs 11.0 nmol/L;  $p = 0.37$ ). The association between age and the effectiveness of the dexamethasone tablet was similar for offspring and partners ( $p$  for interaction = 0.63 when adjusted for age, gender, body mass index, current smoking and disease history).

**Table 3** Salivary cortisol levels after overnight dexamethasone

	Offspring (n = 149)	Partners (n = 154)	P - Value
<b>Salivary cortisol level<sup>1</sup></b>			
Model 1:	4.34 (3.89 – 4.80)	4.79 (4.16 – 5.42)	0.26
Model 2:	4.75 (4.09 – 5.42)	5.21 (4.43 – 6.00)	0.25
Model 3:	4.82 (3.76 – 5.88)	5.26 (4.21 – 6.31)	0.28
Model 4:	4.94 (3.91 – 5.97)	5.26 (4.24 – 6.28)	0.43
<b>Difference levels<sup>2</sup></b>			
Model 1:	11.8 (10.6 – 13.1)	11.9 (10.2 – 13.6)	0.94
Model 2:	11.6 (9.8 – 13.4)	12.3 (10.2 – 14.4)	0.50
Model 3:	10.0 (7.2 – 12.9)	11.0 (8.2 – 13.8)	0.37

Means presented as mean salivary cortisol in nmol/L with 95% confidence interval. Model 1: Crude; Model 2: Adjusted for age, gender, body mass index and current smoking; Model 3: Adjusted for age, gender, body mass index, current smoking and disease history (Type 2 Diabetes and Hypertension); Model 4: Adjusted for age, gender, body mass index, current smoking and disease history (Type 2 Diabetes and Hypertension) and salivary cortisol concentration at awakening on the first day. All analyses were adjusted for familial relationships. 1) Awakening salivary cortisol levels after overnight dexamethasone. 2) Difference between salivary cortisol level on awakening at day 0 and overnight dexamethasone.

## DISCUSSION

In this study we aimed to investigate cortisol levels and cortisol feedback sensitivity in relation to familial longevity. We first showed that salivary cortisol levels were lower in the offspring compared to their partners both in the morning and in the evening. Second, we showed that cortisol feedback sensitivity, as estimated by a dexamethasone suppression test, was similar between offspring and partners, suggesting that the difference between offspring and partners in salivary cortisol concentration is most likely not caused by a difference in cortisol feedback sensitivity.

### Cortisol levels and familial longevity

Previous research showed that, when comparing young and old subjects, cortisol levels were higher during the night in older subjects compared to younger subjects (12, 15). One of the possible reasons for the increase in cortisol is the neuronal loss in the hippocampus resulting in an impaired negative feedback mechanism (14). Research on twins suggests a substantial heritability of 62% on cortisol levels, suggesting a genetic contribution(25). Compared to their partners, the offspring have

a lower incidence of age-related diseases (18), rate of mortality (19) and serum glucose (20) and higher insulin sensitivity (21, 22), suggesting that they are biologically younger. Therefore, the results of the present study might suggest that in middle aged individuals low HPA activity marks better metabolic/cardiovascular health and a lower biological age. In addition, as cortisol was shown to be associated with insulin resistance (9), this study might suggest that the enhanced insulin sensitivity in the offspring might be facilitated by the lower cortisol levels. After adjustment for the two most prevalent age-related diseases (hypertension and type- 2 diabetes), the difference in cortisol levels between offspring and partners persisted, suggesting that is not caused by a difference in disease prevalence.

The cortisol awakening response is dependent on both the circadian rhythm as well as on awakening itself (4). Interestingly, the increase upon awakening (estimated by the AUC<sub>0-30</sub>), was similar in both groups. Because the increase upon awakening was similar in both groups and because the offspring had lower levels of cortisol in both the morning and evening it might be suggested that offspring have lower total cortisol secretion compared to their partners.

Socio- economic status is described to influence the cortisol awakening response also (26). Persons with a low socio-economic status have higher levels of cortisol in the morning compared to persons with a high status. In this study, we compared offspring from nonagenarian siblings with environmentally matched controls (their partners). It is therefore unlikely that the difference between the offspring and partners is confounded by social- economic status.

### **Cortisol sensitivity and familial longevity**

With increasing age, sensitivity to cortisol is decreasing. A recent study showed that increasing the dexamethasone dose has no additional effect on inhibiting cortisol secretion in elderly, whereas it does in younger subjects (16). These results indicate that the negative feedback on the HPA axis is becoming less effective. One of the mechanisms described is the decreased expression of mineralocorticoid receptors in the hippocampus with increasing age (17). In the present study, we showed that cortisol levels after overnight dexamethasone and the effectiveness of dexamethasone were similar in offspring and partners. These results indicate that cortisol sensitivity is similar in both study groups. The lower salivary cortisol levels in the offspring therefore seem not to be due to a difference in cortisol sensitivity. The dose used in this study (0.5 mg) is used for clinical purposes only. As the present study was performed in healthy individuals, the difference in responses may be clearer when a lower dose of dexamethasone was used. Repetition of this experiment with a lower dexamethasone dose might further elucidate whether cortisol feedback sensitivity is associated with familial longevity.

### **Study limitations**

This study has a few limitations to address. As this study was performed home-based, strict standardization and timing by which the saliva samples were taken cannot be ascertained. Additionally, we observed an increase in cortisol levels at 11 pm compared to 10 pm, in which a decrease was expected. A possible explanation could be that subjects who normally slept earlier were subjected to stress when asked to take saliva samples at 11 p.m. (thereby increasing their cortisol level). A third limitation of this study was that we did not have information on depression at the time of the study. Instead, we used information from the pharmacies on antidepressant drug use. The limitation of this strategy is that also participants with, for example, neuropathic pain and anxiety disorders might take antidepressant medication. However, as the number of participants taking antidepressant medication is small, the effect will likely be negligible. Despite these shortcomings, which probably resulted in an increased variation in the dataset, we were still able to demonstrate lower salivary cortisol levels in offspring from long-lived families both in the morning and evening.

### **Conclusion**

In conclusion, the results of this study show that familial longevity might be marked by lower levels of morning and evening cortisol. Dexamethasone suppression tests revealed that it is unlikely that a major change in cortisol feedback sensitivity explains these effects, although a repetition with a lower dose is recommendable. This study describes an association between cortisol levels and familial longevity. More research should be performed to characterize what mechanism is responsible for the lower levels of cortisol in the offspring group. Moreover, more research and replication with increased precision and standardization should be performed to further characterize the differences in HPA axis activity between longevity families and controls.

## REFERENCES

1. **Beyer HS, Matta SG, and Sharp BM.** Regulation of the messenger ribonucleic acid for corticotropin-releasing factor in the paraventricular nucleus and other brain sites of the rat. *Endocrinology*. 1988; 123(4):2117-23.
2. **Kirschbaum C, and Hellhammer DH.** Salivary cortisol in psychobiological research: an overview. *Neuropsychobiology*. 1989;22(3):150-69.
3. **Pruessner JC, Wolf OT, Hellhammer DH, Buske-Kirschbaum A, von Auer K, Jobst S, Kaspers F, and Kirschbaum C.** Free cortisol levels after awakening: a reliable biological marker for the assessment of adrenocortical activity. *Life Sci*. 1997;61(26):2539-49.
4. **Wilhelm I, Born J, Kudielka BM, Schlotz W, and Wust S.** Is the cortisol awakening rise a response to awakening? *Psychoneuroendocrinology*. 2007;32(4):358-66.
5. **Pruessner M, Hellhammer DH, Pruessner JC, and Lupien SJ.** Self-reported depressive symptoms and stress levels in healthy young men: associations with the cortisol response to awakening. *Psychosom Med*. 2003;65(1):92-9.
6. **Tafet GE, Idoyaga-Vargas VP, Abulafia DP, Calandria JM, Roffman SS, Chiovetta A, and Shinitzky M.** Correlation between cortisol level and serotonin uptake in patients with chronic stress and depression. *Cogn AffectBehavNeurosci*. 2001;1(4):388-93.
7. **Bruehl H, Wolf OT, and Convit A.** A blunted cortisol awakening response and hippocampal atrophy in type 2 diabetes mellitus. *Psychoneuroendocrinology*. 2009;34(6):815-21.
8. **Wirtz PH, von Kanel R, Emini L, Ruedisueli K, Groessbauer S, Maercker A, and Ehler U.** Evidence for altered hypothalamus-pituitary-adrenal axis functioning in systemic hypertension: blunted cortisol response to awakening and lower negative feedback sensitivity. *Psychoneuroendocrinology*. 2007; 32(5):430-6.
9. **Phillips DI, Barker DJ, Fall CH, Seckl JR, Whorwood CB, Wood PJ, and Walker BR.** Elevated plasma cortisol concentrations: a link between low birth weight and the insulin resistance syndrome? *J Clin Endocrinol Metab*. 1998;83(3):757-60.
10. **Walker BR, Phillips DI, Noon JP, Panarelli M, Andrew R, Edwards HV, Holton DW, Seckl JR, Webb DJ, and Watt GC.** Increased glucocorticoid activity in men with cardiovascular risk factors. *Hypertension*. 1998;31(4):891-5.
11. **Walker BR, Soderberg S, Lindahl B, and Olsson T.** Independent effects of obesity and cortisol in predicting cardiovascular risk factors in men and women. *J Intern Med*. 2000;247(2):198-204.
12. **Van Cauter E, Leproult R, and Kupfer DJ.** Effects of gender and age on the levels and circadian rhythmicity of plasma cortisol. *J Clin Endocrinol Metab*. 1996;81(7):2468-73.
13. **Knoops AJ, van der Graaf Y, Mali WP, and Geerlings MI.** Age-related changes in hypothalamic-pituitary-adrenal axis activity in patients with manifest arterial disease. *Endocrine*. 2010;37(1):231-8.
14. **Heaney JL, Phillips AC, and Carroll D.** Ageing, physical function, and the diurnal rhythms of cortisol and dehydroepiandrosterone. *Psychoneuroendocrinology*. 2011.
15. **Dotz C, Theine KJ, Uthgenannt D, Born J, and Fehm HL.** Basal secretory activity of the hypothalamo-pituitary-adrenocortical axis is enhanced in healthy elderly. An assessment during undisturbed night-time sleep. *Eur J Endocrinol*. 1994;131(5):443-50.
16. **Hatzinger M, Brand S, Herzig N, and Holsboer-Trachsler E.** In healthy young and elderly adults, hypothalamic-pituitary-adrenocortical axis reactivity (HPA AR) varies with increasing pharmacological challenge and with age, but not with gender. *J Psychiatr Res*. 2011.
17. **Rothuizen J, Reul JM, van Sluijs FJ, Mol JA, Rijnberk A, and de Kloet ER.** Increased neuroendocrine reactivity and decreased brain mineralocorticoid receptor-binding capacity in aged dogs. *Endocrinology*. 1993;132(1):161-8.
18. **Westendorp RG, van Heemst D, Rozing MP, Frolich M, Mooijaart SP, Blauw GJ, Beekman M, Heijmans BT, de Craen AJ, and Slagboom PE.** Nonagenarian siblings and their offspring display lower risk of mortality and morbidity than sporadic nonagenarians: The Leiden Longevity Study. *JAmGeriatrSoc*. 2009;57(9):1634-7.

19. **Schoenmaker M, de Craen AJ, de Meijer PH, Beekman M, Blauw GJ, Slagboom PE, and Westendorp RG.** Evidence of genetic enrichment for exceptional survival using a family approach: the Leiden Longevity Study. *Eur J Hum Genet.* 2006;14(1):79-84.
20. **Roziing MP, Westendorp RG, Frolich M, de Craen AJ, Beekman M, Heijmans BT, Mooijaart SP, Blauw GJ, Slagboom PE, and van Heemst D.** Human insulin/IGF-1 and familial longevity at middle age. *Aging (Albany NY).* 2009;1(8):714-22.
21. **Roziing MP, Westendorp RG, de Craen AJ, Frolich M, de Goeij MC, Heijmans BT, Beekman M, Wijsman CA, Mooijaart SP, Blauw GJ, Slagboom PE, and van Heemst D.** Favorable glucose tolerance and lower prevalence of metabolic syndrome in offspring without diabetes mellitus of nonagenarian siblings: the Leiden longevity study. *J Am Geriatr Soc.* 2010;58(3):564-9.
22. **Wijsman CA, Roziing MP, Streefland TC, le Cessie S, Mooijaart SP, Slagboom PE, Westendorp RG, Pijl H, and van Heemst D.** Familial longevity is marked by enhanced insulin sensitivity. *Aging Cell.* 2011;10(1):114-21.
23. **Schoenmaker M, de Craen AJ, de Meijer PH, Beekman M, Blauw GJ, Slagboom PE, and Westendorp RG.** Evidence of genetic enrichment for exceptional survival using a family approach: the Leiden Longevity Study. *Eur J Hum Genet.* 2006;14(1):79-84.
24. **Pruessner JC, Kirschbaum C, Meinlschmid G, and Hellhammer DH.** Two formulas for computation of the area under the curve represent measures of total hormone concentration versus time-dependent change. *Psychoneuroendocrinology.* 2003;28(7):916-31.
25. **Bartels M, Van den Berg M, Sluyter F, Boomsma DI, and de Geus EJ.** Heritability of cortisol levels: review and simultaneous analysis of twin studies. *Psychoneuroendocrinology.* 2003;28(2):121-37.
26. **Miller GE, Chen E, Fok AK, Walker H, Lim A, Nicholls EF, Cole S, and Kobor MS.** Low early-life social class leaves a biological residue manifested by decreased glucocorticoid and increased proinflammatory signaling. *Proc Natl Acad Sci U S A.* 2009;106(34):14716-21.







# CHAPTER 7

## Characterization of the Hypothalamic-Pituitary-Adrenal-Axis in Familial Longevity under Resting Conditions

Jansen SW, Roelfsema F, Akintola AA, Oei NY, Cobbaert CM, Ballieux PB, van der Grond J, Westendorp RG, Pijl H, van Heemst D.

*PLoS One.* 2015; 10(7): e0133119 doi: 10.1371



## ABSTRACT

**Objective.** The hypothalamic-pituitary-adrenal (HPA)-axis is the most important neuro-endocrine stress response system of our body which is of critical importance for survival. Disturbances in HPA-axis activity have been associated with adverse metabolic and cognitive changes. Humans enriched for longevity have less metabolic and cognitive disturbances and therefore diminished activity of the HPA axis may be a potential candidate mechanism underlying healthy familial longevity. Here, we compared 24-h plasma ACTH and serum cortisol concentration profiles and different aspects of the regulation of the HPA-axis in offspring from long-lived siblings, who are enriched for familial longevity and age-matched controls.

**Design.** Case-control study within the Leiden Longevity study cohort consisting of 20 middle-aged offspring of nonagenarian siblings (offspring) together with 18 partners (controls).

**Methods.** During 24 h, venous blood was sampled every 10 minutes for determination of circulatory ACTH and cortisol concentrations. Deconvolution analysis, cross approximate entropy analysis and ACTH-cortisol-dose response modeling were used to assess, respectively, ACTH and cortisol secretion parameters, feedforward and feedback synchrony and adrenal gland ACTH responsivity.

**Results.** Mean (95% Confidence Interval) basal ACTH secretion was higher in male offspring compared to male controls (645 (324-1286) ng/L/24 h *versus* 240 (120-477) ng/L/24 h,  $P = 0.05$ ). Other ACTH and cortisol secretion parameters did not differ between offspring and controls. In addition, no significant differences in feedforward and feedback synchrony and adrenal gland ACTH responsivity were observed between groups.

**Conclusions.** These results suggest that familial longevity is not associated with major differences in HPA-axis activity under resting conditions, although modest, sex-specific differences may exist between groups that might be clinically relevant.

## INTRODUCTION

The hypothalamic-pituitary-adrenal (HPA)-axis is the most important neuro-endocrine stress response system of our body which is of critical importance for survival. Different stressors can trigger the neurons in paraventricular nuclei of the hypothalamus to secrete corticotrophin-releasing-hormone (CRH). CRH stimulates the pituitary gland to secrete adrenocorticotrophic hormone (ACTH), which binds to ACTH receptors on the adrenal gland and stimulates the secretion of glucocorticoids, of which cortisol is the most important(1). Cortisol inhibits the HPA-axis via classical negative feedback mechanisms involving the hippocampus, hypothalamus and pituitary(1). Tightly controlled regulation of hypothalamic-pituitary-adrenal (HPA)-axis responses is of importance for maintaining both mental and physical health, since both hyper and hypo-activity of the HPA-axis are linked to disease states(1, 2). If untreated, patients with severe Cushing's syndrome, who is characterized by cortisol excess, and patients with adrenal insufficiency, which are cortisol deficient, have a remaining life expectancy of a few years, while restoration of the HPA-axis recues health and substantially increases remaining life expectancy. In addition, diabetes, hippocampal damage(3) and hypertension(4) are associated with a blunted or absent cortisol response after waking up, and higher cortisol levels in the evening are associated with increased blood pressure and insulin resistance(5-7).

The Leiden Longevity Study (LLS) was designed to identify genetic mechanisms underlying healthy familial longevity(8) and comprises nonagenarians with at least one nonagenarian sibling, their offspring and the offspring's partners serving as an age-matched control group. To assess whether our recruitment strategy had resulted in enrichment for familial longevity, we compared the mortality rates of included first degree relatives with those of their respective birth cohorts. We found that all groups of first degree relatives (including parents, additional siblings and offspring) had on average a 30% lower mortality rate compared to their birth cohorts, illustrating a successful enrichment for familial longevity(8). In line, compared to their partners (controls), already at middle age, offspring from nonagenarian siblings (offspring) had lower prevalence of cardiovascular and metabolic diseases(9) and better cognitive performance also after adjustment for potential confounders, including myocardial infarction and type 2 diabetes(10). Moreover, among non-diabetic participants, offspring compared to their partners, had better glucose tolerance(11) and higher insulin sensitivity(12). It is unknown which mechanisms underlie the favorable cardiovascular and metabolic health profile and the survival advantage displayed by the offspring. Since changes in HPA-axis activity have been associated with the adverse metabolic and cognitive changes that typify partners as compared to offspring, diminished basal activity of the HPA axis may a potential candidate mechanism underlying healthy familial longevity. In previous studies in the LLS, we

found in a single morning blood sample no significant difference in cortisol concentrations between offspring and controls(13). However, when taking multiple saliva samples in the morning and evening, the area under the curve (AUC) of morning and evening salivary cortisol concentrations were slightly lower in the offspring(14).

Therefore the purpose of this study was to investigate whether offspring from long-lived siblings enriched for familial longevity, compared to controls, had differences in HPA-axis activity and/or regulation, reflected by different plasma ACTH and serum cortisol concentration profiles over 24 h or distinct hormonal interactions. In the present study we collected blood samples every 10 minutes, which allows for detailed deconvolution analysis of the 24-h ACTH and cortisol concentration profiles to estimate basal, pulsatile and total secretion of ACTH and cortisol over 24 h as well as specific secretion parameters. In addition, we studied the regularity of ACTH and cortisol secretion using approximate entropy (ApEn). Furthermore, we assessed ACTH-cortisol feedforward and cortisol-ACTH feedback synchrony using cross-ApEn. Finally, we assessed adrenal gland sensitivity to ACTH in offspring and controls by modelling an endogenous ACTH-cortisol dose-response relationship.

## **SUBJECTS AND METHODS**

### **Study population**

Participants were derived from the Leiden Longevity Study (LLS), a family based study consisting of 421 families with at least two long-lived siblings (men  $\geq$  89 year, women  $\geq$  91 year) of Dutch descent, without any selection on demographics or health(8, 9). For the current study (Switchbox), 20 offspring from long-lived siblings and 18 controls (partners from offspring) from the LLS were included who met the inclusion criteria of being middle-aged (55-77 years) and having a stable body mass index (BMI) between 19 and 33 kg/m<sup>2</sup>. Exclusion criteria were: any significant chronic, renal, hepatic or endocrine disease, mild depression ( $>$  10 point for the Geriatric depression scale-30) or medication use known to influence any hormonal axis including estrogen replacement therapy for women, anaemia (haemoglobin  $<$  7.1 mmol/L), fasting plasma glucose  $>$  7 mmol/L, recent blood donation or trans-meridian flights, smoking addiction, use of more than 20 units of alcohol per week, or extreme diet therapies. To enhance the contrast in familial longevity between groups, controls with a nonagenarian parent who had one or more nonagenarian siblings were excluded (based on telephone questioning). The Switchbox protocol was approved by the Medical Ethical Committee of the Leiden University Medical Center and was performed according to the Helsinki declaration. All participants gave written informed consent for participation after full explanation of the purpose and nature of all procedures used.

### Clinical protocol

Participants were admitted to the research center at 0800 h, where a catheter was placed in a vein of the forearm of the non-dominant hand. After approximately an hour rest, blood sampling started at 0900 h. During 24 h, every 10 minutes 1.2 mL of blood was collected in a K3-EDTA tube and 2 mL in a serum separator (SST) tube. In total 461 mL of blood was withdrawn from each participant. All participants received standardized feeding at three fixed times during the day (between 0900-1000 h, 1200-1300 h, and 1800-1900 h), each consisting of 600 kcal Nutridrink (Nutricia Advanced Medical Nutrition, Zoetermeer, The Netherlands). Light exposure was standardized and lights were switched off between 2300-0800 h. No naps were allowed and participants ambulated only to the bathroom. All participants were sampled in the same room.

### Assays and assay performance

All measurements were performed at the department of clinical chemistry and laboratory medicine (AKCL) of Leiden University Medical Center, which is accredited according to CCKL (National Coordination Committee for Quality Assurance for Health Care Laboratories in The Netherlands).

Cortisol was measured using an ECLIA assay on a Modular E170 analyser from Roche (Roche Diagnostics, Almere, The Netherlands), ACTH and DHEAS on an Immulite 2000 Xpi analyser (Siemens Healthcare diagnostics, The Hague, The Netherlands) and HbA1c on a Primus Ultra 2 HPLC analyser (Trinity Biotech, Bray, Ireland), using boronate affinity separation. For each participant, all samples from one time series were measured within the same lot number and in the same batch. For this study, the precision and quality of all assayed analytes met or surpassed the level of desirable quality specifications<sup>(15)</sup> (further details see Supporting information methods: Assays and assay performance). In our laboratory the reference range for is ACTH is 3-75 ng/L, for cortisol 0.1-0.6  $\mu\text{mol/L}$ , for HbA1c 20-42 mmol/mol Hb.

### Deconvolution analyses

Each hormone concentration time series was analyzed using an automated deconvolution method. This method was validated using frequent blood sampling, and simulated pulsatile time series, as previously described<sup>(16-18)</sup>. Outcome parameters included number of pulses per 24 h, mean pulse mass, basal and pulsatile secretion, hormone half-lives, pulse mode (time to reach the maximal value) and the Weibull gamma value, representing the regularity of the statistically significant hormone pulses.

### Approximate entropy (ApEn)

ApEn is a scale- and model-independent univariate regularity statistic used to quantitate the orderliness (subpattern consistency) of serial stationary measurements.

Mathematical models and feedback experiments have established that pattern orderliness monitors feedback and/or feed-forward interactions within an interlinked axis with high sensitivity and specificity, both greater than 90%(19). Reduced pattern regularity typifies hormone secretion in puberty and aging, during diminished negative feedback or fixed exogenous stimulation, and by autonomous neuroendocrine tumors(20).

### **Cross-ApEn**

Cross-ApEn is a bivariate, scale-and model-independent two-variable regularity statistic used to quantitate the relative pattern synchrony of coupled time series(21). Changes in the cross-ApEn of cortisol-ACTH reflect feedback synchrony and in the cross-ApEn of ACTH-cortisol reflect the feedforward synchrony with high sensitivity and specificity(22).

### **ACTH-cortisol-dose response measurements**

To explore adrenal gland sensitivity to ACTH in more detail, an endogenous ACTH-cortisol dose response curve was modelled. Details of the dynamic dose-response methodology were described in two previous papers(23, 24). The goal was to relate time-varying plasma ACTH concentrations (input or effector) to time-varying cortisol secretion rates (output or response), based on fitted (deconvolved) ACTH concentrations and (deconvolved) cortisol secretion rates via the four-parameter (basal, potency, sensitivity and efficacy) logistic dose-response model modified to include a potency-down-regulated parameter and matching inflection time(25).

### **Statistical analysis**

All analyses were done using linear regression analysis adjusted for age and BMI to investigate differences between offspring and partners. All data are presented as mean with standard error of the mean (SEM). Logarithmic transformation of data that were not normally distributed (basal, pulsatile and total secretion of ACTH and cortisol) was used to decrease the variation and these data are presented as a geometric mean with 95%-confidence interval (CI).

For all above-mentioned analyses, SPSS for Windows, version 20 (SPSS, Chicago, IL) was used. Graphs were made using GraphPad Prism version 5 (GraphPad, San Diego, CA) and Sigmaplot version 11 (Systat Software, Erkrath, Germany).  $P \leq 0.05$  was considered significant.



## RESULTS

### Baseline characteristics

Baseline characteristics of offspring and controls are presented in Table 1 (for men and women combined and stratified for sex). Participants were selected on the basis of the age of their parents. Consequently, mothers of offspring were significantly older (men and women combined  $P < 0.001$ ). Compared to controls, offspring were of similar age and BMI.

**Table 1** Baseline characteristics of offspring from long-lived siblings and controls, in all participants and stratified for sex.

	All participants		Men		Women	
	Offspring n=20	Controls n=18	Offspring n=10	Controls n=10	Offspring n=10	Controls n=8
<b>Parental age</b>						
Mother (yr)	94.5 (89-97)	81.5 (77-88)	96.0 (88-98)	83.0 (77-88)	93.0 (89-97)	79.5 (68-88)
Father (yr)	89.5 (72-96)	78.0 (74-82)	89.5 (68-96)	77.0 (71-80)	89.5 (71-97)	80.0 (73-85)
<b>Demographics</b>						
Age (yr)	65.5 (5.4)	64.6 (4.9)	66.6 (6.4)	64.6 (4.0)	64.7 (4.4)	64.5 (6.1)
BMI (kg/m <sup>2</sup> ) <sup>a</sup>	25.4 (4.0)	25.5 (3.9)	26.0 (3.4)	25.9 (3.2)	24.7 (4.6)	24.9 (4.8)
<b>Laboratory results</b>						
HbA1c (mmol/mol Hb)	34.6 (1.5)	35.4 (2.0)	34.6 (1.9)	35.5 (1.8)	34.7 (1.3)	35.3 (2.4)

All data are presented as the median with interquartile range or as the mean with standard deviation.

<sup>a</sup>BMI: Body Mass Index.

### Twenty-four hour hormone concentration profiles

Mean 24-h plasma ACTH and serum cortisol concentration profiles are displayed in Fig 1. By visual inspection, ACTH concentrations seemed higher in offspring between 1700 and 0100 h, while there were no differences in cortisol concentrations (all participants, Fig. 1A and 1B). In males no differences in 24-h ACTH concentrations were visible while cortisol levels during the day seemed lower in male offspring (Fig. 1C and 1D). Female offspring seemed to have higher plasma concentrations of ACTH

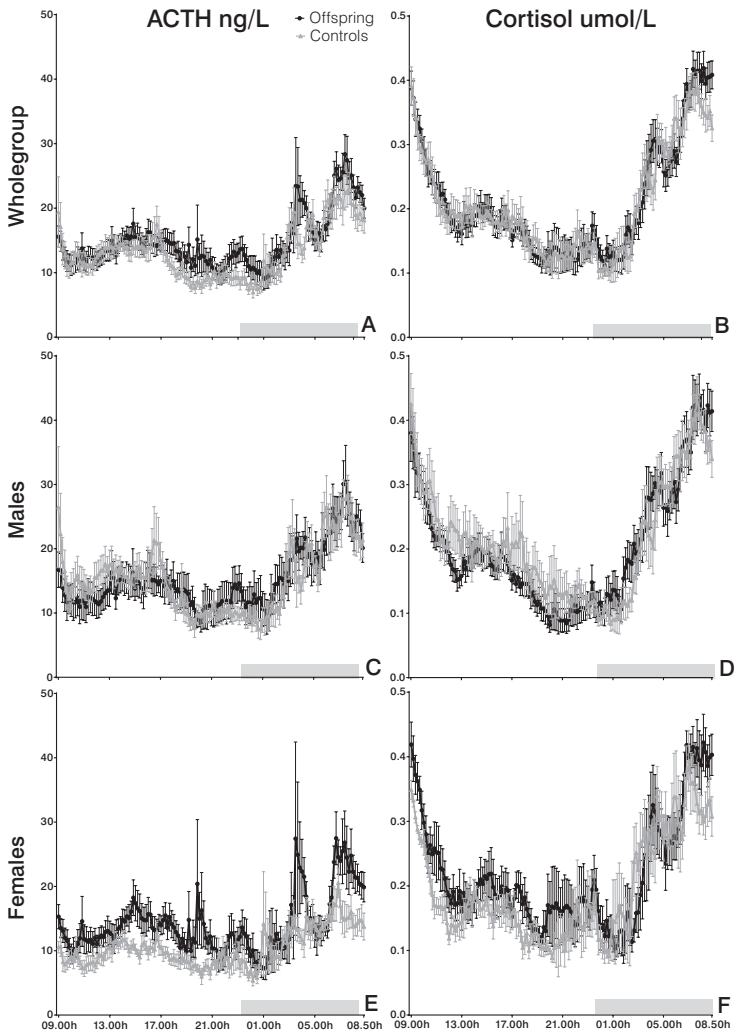

**Figure 1** Mean 24-h concentration profiles of ACTH and cortisol in all participants and stratified for sex.

The black dots represent hormone concentrations of 20 offspring and the grey triangles represent hormone concentrations of 18 controls every 10 minutes over a 24-h period for (A) ACTH and (B) cortisol. The black dots represent hormone concentrations of 10 male offspring and the grey triangles represent hormone concentrations of 8 male controls every 10 minutes over a 24-h period for (C) ACTH and (D) cortisol. The black dots represent hormone concentrations of 10 female offspring and the grey triangles represent hormone concentrations of 10 female controls every 10 minutes over a 24-h period for (E) ACTH and (F) cortisol. Error bars represents the standard error of the mean. Grey rectangle represents the night period (0000h-0700 h).

and serum concentrations of cortisol during the day (Fig. 1E and 1F). However, mean plasma ACTH and mean serum cortisol concentrations did not differ between groups in any of these time periods (Table 2).

### ACTH and cortisol secretion

Results of the deconvolution analyses are displayed in Table 3. In men and women combined, there were no significant differences in basal, pulsatile and total ACTH and cortisol secretion between offspring and controls over 24 h. Mean (95% CI) basal ACTH secretion was higher in male offspring compared to male controls (645 (324-1286) ng/L/24 h *versus* 240 (120-477) ng/L/24 h,  $P = 0.05$ ). When basal ACTH secretion was measured over 3 different time periods (0900-1700 h, 1700-2400 h and 2400-0800 h), it tended to be higher in male offspring, but did not reach statistical significance in one of the three time periods (S1 Table). Except for a lower basal cortisol secretion from 1700 – 2400 h in offspring, no differences were observed in cortisol secretion between groups over the three time periods in men (S1 Table). In women, there were no significant differences in basal, pulsatile or total ACTH or cortisol secretion between offspring and controls over 24 h (Table 3). When analyzed over the three time periods separately, no differences were observed between groups in women, except for a higher pulsatile ACTH secretion in offspring between 0900-1700 h (188 (141-251) ng/L *versus* 107 (78-148) ng/L,  $P = 0.02$ ) and a higher basal cortisol secretion from 1700 – 2400 h in the offspring (S1 Table).

ACTH and cortisol parameters e.g. the slow half-life, pulse frequency, mean pulse mass and pulse mode during day and night were not different in offspring and controls, neither when men and women were combined nor when stratified for sex (S1 Fig.).

There were no significant differences between offspring compared to controls in ACTH ApEn when men and women were combined ( $1.26 \pm 0.07$  *versus*  $1.24 \pm 0.07$ ,  $P = 0.86$ ) or in cortisol ApEn ( $1.07 \pm 0.04$  *versus*  $1.13 \pm 0.05$ ,  $P = 0.34$ ), nor when stratified for sex (Table 4).

### HPA-axis dynamics

ACTH-cortisol cross-ApEn, reflecting feedforward synchrony, was not different between offspring and partners when men and women were combined ( $1.41 \pm 0.07$  *versus*  $1.39 \pm 0.07$ ,  $P = 0.84$ ), nor when stratified for sex (Table 4). In addition, cortisol-ACTH cross-ApEn, reflecting feedback synchrony, was not significantly different in offspring and controls when men and women were combined ( $1.33 \pm 0.06$  *versus*  $1.29 \pm 0.06$ ,  $P = 0.67$ ), and also not when stratified for sex (Table 4).

The sensitivity of the adrenal gland for ACTH in both offspring and controls was assessed by modeling the endogenous ACTH-cortisol dose-response relationship (Fig. 2). There were no differences in the endogenous ACTH-cortisol dose-response

**Table 2** Mean plasma ACTH and serum cortisol concentrations in all participants and stratified for sex.

	All participants			Men			Women		
	Offspring n=20	Controls n=18	P-value	Offspring n=10	Controls n=10	P-value	Offspring n=10	Controls n=8	P-value
<b>ACTH (ng/L)</b>									
24-h period	14.0 (11.8-16.5)	13.0 (10.9-15.6)	0.57	14.6 (11.4-18.8)	15.5 (12.0-19.9)	0.74	13.4 (10.8-16.6)	10.5 (8.3-13.4)	0.14
0900-1700 h	12.8 (10.7-15.3)	12.6 (10.5-15.2)	0.91	13.0 (10.0-17.0)	15.3 (11.7-20.0)	0.38	12.6 (10.1-15.8)	9.9 (7.7-12.8)	0.15
1700-0100 h	11.0 (9.3-13.2)	9.2 (7.7-11.1)	0.16	11.4 (8.7-14.9)	10.0 (7.6-13.0)	0.47	10.7 (8.3-13.9)	8.4 (6.3-11.2)	0.19
0100-0900 h	17.8 (14.8-21.3)	16.8 (13.8-20.3)	0.66	19.1 (14.7-25.0)	20.4 (15.6-26.7)	0.72	16.5 (13.0-20.9)	13.1 (10.1-17.1)	0.19
<b>Cortisol (nmol/L)</b>									
24-h period	206 (188-226)	204 (186-225)	0.92	201 (177-227)	211 (186-239)	0.57	211 (181-245)	196 (166-233)	0.52
0900-1700 h	210 (187-236)	209 (184-236)	0.95	204 (171-244)	229 (191-274)	0.36	216 (185-253)	186 (156-222)	0.20
1700-0100 h	126 (106-152)	127 (105-154)	0.95	110 (86-142)	128 (100-164)	0.38	145 (110-192)	126 (92-173)	0.50
0100-0900 h	249 (251-302)	268 (243-296)	0.68	282 (254-313)	267 (240-296)	0.45	269 (227-320)	270 (223-326)	0.99

Data are presented as a geometric mean with 95% confidence interval. Statistical significance was calculated with linear regression.

**Table 3** ACTH and cortisol secretion in all participants and stratified for sex.

	All participants			Men			Women		
	Offspring n = 20	Controls n = 18	P-value	Offspring n = 10	Controls n = 10	P -value	Offspring n = 10	Controls n = 8	P -value
<b>ACTH</b>									
Basal (ng/L/24 h)	556 (360-859)	351 (222-555)	0.15	645 (324-1286)	240 (120-477)	0.05	485 (266-884)	556 (284-1088)	0.75
Pulsatile (ng/L/24 h)	609 (482-770)	786 (614-1007)	0.14	676 (490-933)	895 (649-1235)	0.21	556 (377-821)	657 (425-1016)	0.55
Total (ng/L/24 h)	1333 (1091-1629)	1235 (1000-1525)	0.60	1477 (1112-1965)	1234 (976-1639)	0.36	1206 (871-1669)	1234 (858-1774)	0.92
<b>Cortisol</b>									
Basal (nmol/L/24 h)	476 (216-1049)	708 (308-1631)	0.49	486 (146-1662)	721 (217-2392)	0.63	483 (133-1742)	662 (158-2774)	0.73
Pulsatile (nmol/L/24 h)	4487 (4000-5034)	4320 (3828-4880)	0.65	4298 (3678-5019)	4803 (4109-5608)	0.31	4708 (3971-5586)	3767 (3112-4555)	0.08
Total (nmol/L/24 h)	5481 (4803-6248)	5324 (4638-6118)	0.76	5351 (4452-6438)	5773 (4798-6940)	0.56	5631 (4583-6926)	4793 (3805-6039)	0.28

Data are presented as adjusted geometric mean with 95% confidence interval. Secretion rates were calculated with deconvolution analysis. Linear regression analyses were adjusted for age and BMI.

**Table 4** ApEn reflecting regularity of ACTH and cortisol secretory patterns and their cross-ApEn reflecting feedforward and feedback synchrony.

	All participants			Men			Women		
	Offspring n=20	Controls n=18	P-value	Offspring n=10	Controls n=10	P-value	Offspring n=10	Controls n=8	P-value
<b>ApEn</b>									
ACTH	1.26 (0.07)	1.24 (0.07)	0.86	1.29 (0.09)	1.11 (0.09)	0.22	1.23 (0.09)	1.41 (0.10)	0.18
Cortisol	1.07 (0.04)	1.13 (0.05)	0.34	1.07 (0.07)	1.12 (0.07)	0.62	1.08 (0.06)	1.16 (0.07)	0.36
<b>cross-ApEn</b>									
ACTH-Cortisol (feedforward)	1.41 (0.07)	1.39 (0.07)	0.84	1.40 (0.10)	1.23 (0.10)	0.24	1.42 (0.09)	1.60 (0.10)	0.19
Cortisol-ACTH (feedbackward)	1.33 (0.06)	1.29 (0.06)	0.67	1.34 (0.09)	1.21 (0.09)	0.31	1.31 (0.07)	1.40 (0.07)	0.37

Data are presented as mean with standard error of the mean (SEM). Linear regression analyses were adjusted for age and BMI.

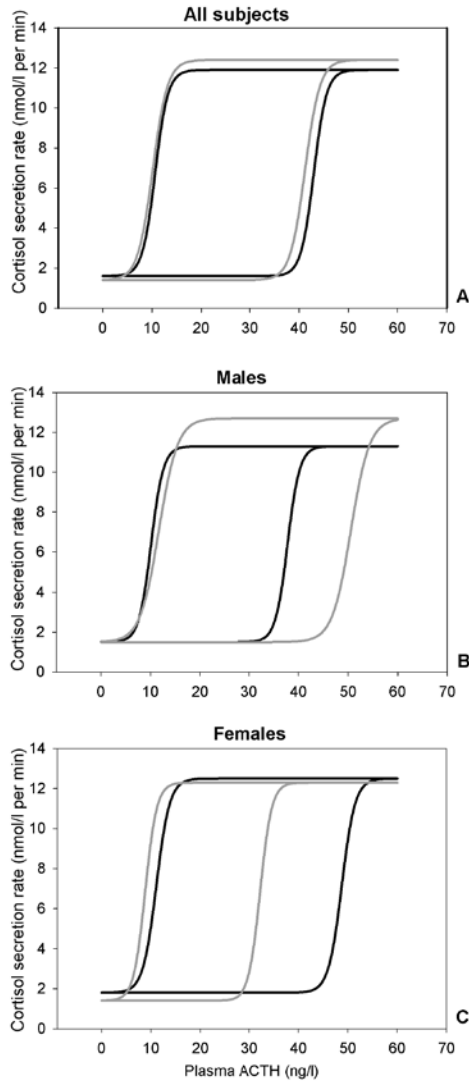

**Figure 2** Adrenal gland responsivity to ACTH in all participants and stratified for sex.

Adrenal gland responsivity to ACTH in an estimated endogenous ACTH-cortisol dose-response relationship in (A) 20 offspring (black line) and 18 controls (grey line). (B) 10 female offspring (black line) and 8 female controls (grey line). (C) 10 male offspring (black line) 10 male controls (grey line).

In all panels, the left curves represent the dose-response during the initial phase of the secretory ACTH pulse, and the right curves represent the recovery phase, i.e. the decreasing part of the ACTH pulse, displaying the down-regulation.

relationship between offspring and controls (Fig. 2A). Male offspring compared to controls had a tendency towards a lower mean (95% CI) recovery  $EC_{50}$ , but this did not reach statistical significance (38.0 (31.0-46.6) ng/L *versus* 50.5 (41.1-61.9) ng/L,  $P = 0.06$ ) (Fig 2B). In women, there were no differences between groups in the endogenous ACTH-cortisol dose-response relationship (Fig 2C).

## DISCUSSION

In this study, we investigated whether human longevity is associated with differences in HPA-axis regulation in offspring enriched for familial longevity compared to controls. We did not observe significant differences between offspring compared to controls in 24-h mean plasma concentrations of ACTH and serum concentrations of cortisol, or in their mean concentrations over 8 hr periods, although mean plasma ACTH concentrations tended to be non-significantly higher in female offspring compared to female controls over all time windows analyzed. In addition, male offspring had a higher basal ACTH secretion compared to male controls but no other differences were observed between groups in the deconvolution-derived 24-h secretion parameters of ACTH and cortisol. We did also not observe significant differences between groups in secretory regularity of ACTH and cortisol; in ACTH-cortisol feedforward and cortisol-ACTH feedback synchrony; or in endogenous ACTH-cortisol dose-response relationship, except for a trend towards a lower recovery  $EC_{50}$  in the endogenous ACTH-cortisol dose-response relationship in male offspring. These results suggest that familial longevity is not associated with major differences in the HPA-axis activity under resting conditions, although modest, sex-specific differences may exist between groups that might be clinically relevant.

Modest, sex-specific differences between groups included the trend towards a higher mean 24h ACTH in female offspring, and in males a significantly higher basal ACTH secretion in offspring and a borderline non-significant lower recovery  $EC_{50}$  in the endogenous ACTH-cortisol dose-response relationship. Although these measures reflect different features of the complex interplay between ACTH drive and cortisol output and feedback inhibition, these observations may hint at the existence of subtle, sex-specific differences between groups in the dynamics of the HPA axis. Previously, genetic polymorphisms in the glucocorticoid receptor which were associated in vivo with subtle differences in glucocorticoid feedback sensitivity have been associated with a more favorable glucose and lipid profiles as well as increased survival in a cohort of elderly men(26, 27). Although a similar survival benefit was not found in another cohort of elderly(28), these results indicate that subtle changes in the dynamics of the HPA axis might have long-lasting clinical impact. Moreover, ACTH may have direct effects on metabolic tissues. Cold exposure activates the HPA



axis, with ACTH having stimulatory and corticosterone having inhibitory effects on brown adipose tissue activity and browning of white adipose tissue(29). Thus, subtle differences in the dynamic interplay between ACTH and cortisol may have pleiotropic effects on physiological processes beyond adrenal output that may have implications for metabolic health.

The HPA-axis can be modified by several factors, including age, sex, BMI, social economic status, chronic illness, psychiatric disorders and sleep disruption(30, 31). Some studies have observed increased cortisol levels in aged compared to young participants(32-34) or in cortisol production rate(35), others found a potential age-dependent decline in total 24-h cortisol secretion(36) or no significant relationship between age and various measures of cortisol secretion(37-39). No differences between young and aged participants were found in single ACTH levels during day and night(38) or in 24-h secretion rate(40), while one study found only in women age-related higher ACTH(41). The two other important determinants of the HPA-axis are BMI and sex. Higher BMI leads to amplified ACTH and cortisol secretion, the latter without increased serum levels(35, 40, 42), while the influence of sex on the HPA-axis is less clear. One study found higher cortisol secretion in men(43), in other studies, women above 50 yr had higher cortisol levels than men(32). Twenty-four hour secretion rate decreased by age in men, but increased in women(44), while no sex difference was found in two other studies(35, 45). On the other hand, ACTH secretion is higher in men than women(40, 45). In the present study, in which the two groups were comparable with respect to mean BMI, age and sex distribution, no differences in mean 24-h hormone levels were found, except for a slightly higher basal (but not total) ACTH secretion in male offspring. Thus, our hypothesis that longevity is associated with lower cortisol secretion was not confirmed in this study. The findings that there were no differences in cortisol secretion and mean cortisol levels were not in agreement with previous data of this cohort, where a slightly lower area under the curve (AUC) of morning and evening saliva cortisol was found in 149 offspring compared to 154 controls(14). This contradictory result may be caused by differences in the analytical methods (saliva *versus* intensive blood sampling), in data analysis (AUC by four and two data points *versus* deconvolution-derived secretion rates based on 144 blood samples in each individual), in setting (home-based *versus* clinical setting), in the study sample size, or by differences in selection criteria on health of the participants(14). Aging in the Brown Norway rat, who are long-living with a 50% survival beyond 2.5 year, is characterized by unchanged serum corticosterone levels with amplified ACTH secretion(46). Long-lived Brown Norway rat(47) exhibit distinct differences in HPA-axis activity and reactivity. These include a faster recovery after restraint stress, larger adrenals that are less reactive to ACTH, higher efficiency of glucocorticoid receptor, and an apparent insensitivity to adrenalectomy. These later differences have been associated with genetic differences, amongst others in

the mineralocorticoid receptor(48). The Wistar Kyoto (WKY) rat is characterized by shorter life-span and hyper-reactivity to stressors(49). Thus in rats, genetic differences in HPA-axis activity and reactivity have been associated with differences in lifespan.

The secretory regularity of ACTH in humans is age- and sex-independent(40), but obesity amplifies ACTH secretion, which is accompanied by decreased pattern regularity (increased ApEn)(50). Cortisol secretion during normal aging becomes less regular, but not with obesity(40, 50). Pattern synchrony, both feedforward and feedback, diminishes during aging(40). In the present study, a comparable feed-forward drive on cortisol, feedback on ACTH (respectively no differences in ApEn ACTH and Cortisol) and synchrony coupling between both hormone rhythms were found in offspring and controls (cross-ApEn ACTH cortisol and cross-ApEn cortisol ACTH). The finding of unchanged ACTH ApEn is also in line with previous research where we demonstrated no differences in cortisol feedback sensitivity between offspring enriched for longevity compared to controls, assessed by overnight dexamethasone suppression test and salivary cortisol levels the next morning in a home-based setting(14).

A new development in the HPA field is assessment of the endogenous ACTH-cortisol dose-response relationship, using prevailing physiological ACTH concentrations and resulting cortisol secretion rates(44). Obesity in women is associated with decreased efficacy (maximal secretion) and sensitivity (slope), together with increased  $ED_{50}$ , fully explaining non-increased serum cortisol levels in spite of increased plasma ACTH concentrations(24). Increasing age and BMI diminishes sensitivity, while efficacy is increased in women, but decreased in men during aging. These changes in dose-response relationship tend to increase cortisol secretion in elderly women, in contrast to decreasing secretion in men, as found in some studies(32, 44). In this study, no group and gender differences in efficacy or sensitivity of the adrenal gland to ACTH were observed.

In this study we were not able to detect major differences in HPA-axis in human enriched for familial longevity, although modest, sex-specific differences may exist between groups that might be clinically relevant. The moderate differences that we observed between groups have resulted in limited power to detect differences in parameters of the HPA axis between groups in the relatively small sample sizes that were available for the current study. The biggest difference observed between groups was a higher mean 24h ACTH concentration in female offspring compared to female controls. Given the observed mean (SD) 24h ACTH concentrations in female offspring and female controls, a sufficiently powered study (with significance of 0.05 and power of 80%) would have required double the sample size of the current study to detect significant differences between groups, namely 20 female offspring and 20 female controls. The observed differences between groups for mean (SD) 24h cortisol were even smaller and would thus have required even bigger sample sizes

for sufficient power to detect significant differences between groups. Although the small study sample is a limitation of this study, the differences in age of the parents between offspring and controls is more than 12 years, which strongly suggests that our recruitment strategy to enrich for familial longevity was successful. Moreover, using the same sample size, we have been able to detect relatively large differences between groups in parameters of the hypothalamic-pituitary-thyroid (HPT)-axis, notably 60% higher mean 24-h concentrations of TSH(51). Differences in the HPT-axis have been associated with longevity in animal models as well as in different human cohorts(52). Future research should focus on disentangling differences between groups in acute rise in cortisol level in response to acute psychological stressors and physiological challenges.

## REFERENCES

1. **Sapolsky RM, Krey LC, and McEwen BS.** The neuroendocrinology of stress and aging: the glucocorticoid cascade hypothesis. *Endocr Rev.* 1986;7(3):284-301.
2. **Lupien SJ, de Leon M, de Santi S, Convit A, Tarshish C, Nair NP, Thakur M, McEwen BS, Hauger RL, and Meaney MJ.** Cortisol levels during human aging predict hippocampal atrophy and memory deficits. *Nat Neurosci.* 1998;1(1):69-73.
3. **Bruehl H, Wolf OT, and Convit A.** A blunted cortisol awakening response and hippocampal atrophy in type 2 diabetes mellitus. *Psychoneuroendocrinology.* 2009;34(6):815-21.
4. **Wirtz PH, von Kanel R, Emini L, Ruedisueli K, Groessbauer S, Maercker A, and Ehler U.** Evidence for altered hypothalamus-pituitary-adrenal axis functioning in systemic hypertension: blunted cortisol response to awakening and lower negative feedback sensitivity. *Psychoneuroendocrinology.* 2007;32(5):430-6.
5. **Walker BR, Phillips DI, Noon JP, Panarelli M, Andrew R, Edwards HV, Holton DW, Seckl JR, Webb DJ, and Watt GC.** Increased glucocorticoid activity in men with cardiovascular risk factors. *Hypertension.* 1998;31(4):891-5.
6. **Walker BR, Soderberg S, Lindahl B, and Olsson T.** Independent effects of obesity and cortisol in predicting cardiovascular risk factors in men and women. *J Intern Med.* 2000;247(2):198-204.
7. **Phillips DI, Barker DJ, Fall CH, Seckl JR, Whorwood CB, Wood PJ, and Walker BR.** Elevated plasma cortisol concentrations: a link between low birth weight and the insulin resistance syndrome? *J Clin Endocrinol Metab.* 1998;83(3):757-60.
8. **Schoenmaker M, de Craen AJ, de Meijer PH, Beekman M, Blauw GJ, Slagboom PE, and Westendorp RG.** Evidence of genetic enrichment for exceptional survival using a family approach: the Leiden Longevity Study. *Eur J Hum Genet.* 2006;14(1):79-84.
9. **Westendorp RG, van Heemst D, Rozing MP, Frolich M, Mooijaart SP, Blauw GJ, Beekman M, Heijmans BT, de Craen AJ, Slagboom PE, and Leiden Longevity Study G.** Nonagenarian siblings and their offspring display lower risk of mortality and morbidity than sporadic nonagenarians: The Leiden Longevity Study. *J Am Geriatr Soc.* 2009;57(9):1634-7.
10. **Stijntjes M, de Craen AJ, van Heemst D, Meskers CG, van Buchem MA, Westendorp RG, Slagboom PE, and Maier AB.** Familial longevity is marked by better cognitive performance at middle age: the Leiden Longevity Study. *PLoS One.* 2013;8(3):e57962.
11. **Rozing MP, Westendorp RG, de Craen AJ, Frolich M, de Goeij MC, Heijmans BT, Beekman M, Wijsman CA, Mooijaart SP, Blauw GJ, Slagboom PE, van Heemst D, and Leiden Longevity Study G.** Favorable glucose tolerance and lower prevalence of metabolic syndrome in offspring without diabetes mellitus of nonagenarian siblings: the Leiden longevity study. *J Am Geriatr Soc.* 2010;58(3):564-9.
12. **Wijsman CA, Rozing MP, Streefland TC, le Cessie S, Mooijaart SP, Slagboom PE, Westendorp RG, Pijl H, van Heemst D, and Leiden Longevity Study g.** Familial longevity is marked by enhanced insulin sensitivity. *Aging Cell.* 2011;10(1):114-21.
13. **Noordam R, Gunn DA, Tomlin CC, Rozing MP, Maier AB, Slagboom PE, Westendorp RG, van Heemst D, de Craen AJ, and Leiden Longevity Study g.** Cortisol serum levels in familial longevity and perceived age: the Leiden longevity study. *Psychoneuroendocrinology.* 2012;37(10):1669-75.
14. **Noordam R, Jansen SW, Akintola AA, Oei NY, Maier AB, Pijl H, Slagboom PE, Westendorp RG, van der Grond J, de Craen AJ, van Heemst D, and Leiden Longevity Study g.** Familial longevity is marked by lower diurnal salivary cortisol levels: the Leiden Longevity Study. *PLoS One.* 2012;7(2):e31166.
15. **Fraser CG.** *Biological Variation: From Principles to Practice.* Washington, DC: AACC Press; 2001.
16. **Liu PY, Keenan DM, Kok P, Padmanabhan V, O'Byrne KT, and Veldhuis JD.** Sensitivity and specificity of pulse detection using a new deconvolution method. *Am J Physiol Endocrinol Metab.* 2009;297(2):E538-44.
17. **Keenan DM, Chattopadhyay S, and Veldhuis JD.** Composite model of time-varying appearance and disappearance of neurohormone pulse signals in blood. *J Theor Biol.* 2005;236(3):242-55.
18. **Keenan DM, Roelfsema F, Biermasz N, and Veldhuis JD.** Physiological control of pituitary hormone secretory-burst mass, frequency, and waveform: a statistical formulation and analysis. *Am J Physiol Regul Integr Comp Physiol.* 2003;285(3):R664-73.

19. **Veldhuis JD, Keenan DM, and Pincus SM.** Motivations and methods for analyzing pulsatile hormone secretion. *Endocr Rev.* 2008;29(7):823-64.
20. **Pincus SM.** Irregularity and asynchrony in biologic network signals. *Methods Enzymol.* 2000;321(149-82).
21. **Pincus S, and Singer BH.** Randomness and degrees of irregularity. *Proc Natl Acad Sci U S A.* 1996; 93(5):2083-8.
22. **Veldhuis JD, Straume M, Iranmanesh A, Mulligan T, Jaffe C, Barkan A, Johnson ML, and Pincus S.** Secretory process regularity monitors neuroendocrine feedback and feedforward signaling strength in humans. *Am J Physiol Regul Integr Comp Physiol.* 2001;280(3):R721-9.
23. **Keenan DM, Licinio J, and Veldhuis JD.** A feedback-controlled ensemble model of the stress-responsive hypothalamo-pituitary-adrenal axis. *Proc Natl Acad Sci U S A.* 2001;98(7):4028-33.
24. **Roelfsema F, Pijl H, Keenan DM, and Veldhuis JD.** Diminished adrenal sensitivity and ACTH efficacy in obese premenopausal women. *Eur J Endocrinol.* 2012;167(5):633-42.
25. **Keenan DM, Roelfsema F, and Veldhuis JD.** Dose-response downregulation within the span of single interpulse intervals. *Am J Physiol Regul Integr Comp Physiol.* 2010;299(1):R11-8.
26. **van Rossum EF, Feelders RA, van den Beld AW, Uitterlinden AG, Janssen JA, Ester W, Brinkmann AO, Grobbee DE, de Jong FH, Pols HA, Koper JW, and Lamberts SW.** Association of the ER22/23EK polymorphism in the glucocorticoid receptor gene with survival and C-reactive protein levels in elderly men. *Am J Med.* 2004;117(3):158-62.
27. **van Rossum EF, Koper JW, Huizenga NA, Uitterlinden AG, Janssen JA, Brinkmann AO, Grobbee DE, de Jong FH, van Duyn CM, Pols HA, and Lamberts SW.** A polymorphism in the glucocorticoid receptor gene, which decreases sensitivity to glucocorticoids in vivo, is associated with low insulin and cholesterol levels. *Diabetes.* 2002;51(10):3128-34.
28. **Kuningas M, Mooijaart SP, Slagboom PE, Westendorp RG, and van Heemst D.** Genetic variants in the glucocorticoid receptor gene (NR3C1) and cardiovascular disease risk. The Leiden 85-plus Study. *Biogerontology.* 2006;7(4):231-8.
29. **van den Beukel JC, Grefhorst A, Quarta C, Steenbergen J, Mastroberardino PG, Lombes M, Delhanty PJ, Mazza R, Pagotto U, van der Lely AJ, and Themmen AP.** Direct activating effects of adrenocorticotrophic hormone (ACTH) on brown adipose tissue are attenuated by corticosterone. *FASEB J.* 2014;28(11):4857-67.
30. **Seeman T, Epel E, Gruenewald T, Karlamangla A, and McEwen BS.** Socio-economic differentials in peripheral biology: cumulative allostatic load. *Ann N Y Acad Sci.* 2010;1186(223-39).
31. **Veldhuis JD, Sharma A, and Roelfsema F.** Age-dependent and gender-dependent regulation of hypothalamic-adrenocorticotrophic-adrenal axis. *Endocrinol Metab Clin North Am.* 2013;42(2):201-25.
32. **Van Cauter E, Leproult R, and Kupfer DJ.** Effects of gender and age on the levels and circadian rhythmicity of plasma cortisol. *J Clin Endocrinol Metab.* 1996;81(7):2468-73.
33. **Halbreich U, Asnis GM, Zumoff B, Nathan RS, and Shindeldecker R.** Effect of age and sex on cortisol secretion in depressives and normals. *Psychiatry Res.* 1984;13(3):221-9.
34. **Deuschle M, Gotthardt U, Schweiger U, Weber B, Korner A, Schmider J, Standhardt H, Lammers CH, and Heuser I.** With aging in humans the activity of the hypothalamus-pituitary-adrenal system increases and its diurnal amplitude flattens. *Life Sci.* 1997;61(22):2239-46.
35. **Purnell JQ, Brandon DD, Isabelle LM, Loriaux DL, and Samuels MH.** Association of 24-hour cortisol production rates, cortisol-binding globulin, and plasma-free cortisol levels with body composition, leptin levels, and aging in adult men and women. *J Clin Endocrinol Metab.* 2004;89(1):281-7.
36. **Sharma M, Palacios-Bois J, Schwartz G, Iskandar H, Thakur M, Quirion R, and Nair NP.** Circadian rhythms of melatonin and cortisol in aging. *Biol Psychiatry.* 1989;25(3):305-19.
37. **Sherman B, Wysham C, and Pfohl B.** Age-related changes in the circadian rhythm of plasma cortisol in man. *J Clin Endocrinol Metab.* 1985;61(3):439-43.
38. **Waltman C, Blackman MR, Chrousos GP, Riemann C, and Harman SM.** Spontaneous and glucocorticoid-inhibited adrenocorticotrophic hormone and cortisol secretion are similar in healthy young and old men. *J Clin Endocrinol Metab.* 1991;73(3):495-502.

39. **Toutiou Y, Sulon J, Bogdan A, Reinberg A, Sodoyez JC, and Demey-Ponsart E.** Adrenocortical hormones, ageing and mental condition: seasonal and circadian rhythms of plasma 18-hydroxy-11-deoxycorticosterone, total and free cortisol and urinary corticosteroids. *J Endocrinol.* 1983;96(1):53-64.
40. **Veldhuis JD, Roelfsema F, Iranmanesh A, Carroll BJ, Keenan DM, and Pincus SM.** Basal, pulsatile, entropic (patterned), and spiky (staccato-like) properties of ACTH secretion: impact of age, gender, and body mass index. *J Clin Endocrinol Metab.* 2009;94(10):4045-52.
41. **Ferrari E, Magri F, Dori D, Migliorati G, Nescis T, Molla G, Fioravanti M, and Solerte SB.** Neuroendocrine correlates of the aging brain in humans. *Neuroendocrinology.* 1995;61(4):464-70.
42. **Roelfsema F, Kok P, Frolich M, Pereira AM, and Pijl H.** Disordered and increased adrenocorticotropin secretion with diminished adrenocorticotropin potency in obese in premenopausal women. *J Clin Endocrinol Metab.* 2009;94(8):2991-7.
43. **Vierhapper H, Nowotny P, and Waldhausl W.** Production rates of cortisol in men with hypogonadism. *Metabolism.* 2004;53(9):1174-6.
44. **Keenan DM, Roelfsema F, Carroll BJ, Iranmanesh A, and Veldhuis JD.** Sex defines the age dependence of endogenous ACTH-cortisol dose responsiveness. *Am J Physiol Regul Integr Comp Physiol.* 2009;297(2):R515-23.
45. **Veldhuis JD, Iranmanesh A, Roelfsema F, Aoun P, Takahashi P, Miles JM, and Keenan DM.** Tripartite control of dynamic ACTH-cortisol dose responsiveness by age, body mass index, and gender in 111 healthy adults. *J Clin Endocrinol Metab.* 2011;96(9):2874-81.
46. **van Eekelen JA, Rots NY, Sutanto W, and de Kloet ER.** The effect of aging on stress responsiveness and central corticosteroid receptors in the brown Norway rat. *Neurobiol Aging.* 1992;13(1):159-70.
47. **Mos J, and Hollander CF.** Analysis of survival data on aging rat cohorts: pitfalls and some practical considerations. *Mech Ageing Dev.* 1987;38(1):89-105.
48. **Marissal-Arvy N, Lombes M, Petterson J, Moisan MP, and Mormede P.** Gain of function mutation in the mineralocorticoid receptor of the Brown Norway rat. *J Biol Chem.* 2004;279(38):39232-9.
49. **Tizabi Y, Aguilera G, and Gilad GM.** Age-related reduction in pituitary corticotropin-releasing hormone receptors in two rat strains. *Neurobiol Aging.* 1992;13(2):227-30.
50. **Kok P, Roelfsema F, Frolich M, van Pelt J, Meinders AE, and Pijl H.** Bromocriptine reduces augmented thyrotropin secretion in obese premenopausal women. *J Clin Endocrinol Metab.* 2009;94(4):1176-81.
51. **SW Jansen AA, F Roelfsema, E van der Spoel, CM Cobbaert et al.,.** Human Longevity is characterized by high thyroid stimulating hormone secretion without altered energy metabolism. *Scientific reports (in press).* 2015.
52. **Bowers J, Terrien J, Clerget-Froidevaux MS, Gothie JD, Rozing MP, Westendorp RG, van Heemst D, and Demeneix BA.** Thyroid hormone signaling and homeostasis during aging. *Endocr Rev.* 2013; 34(4):556-89.







# CHAPTER 8

## Physiological Responding to Stress in Middle-Aged Males Enriched for Longevity: A Social Stress Study

Jansen SW, van Heemst D, van der Grond J, Westendorp RG, Oei NY.  
*Stress*. 2015 Nov 9:1-9. doi:10.3109



## ABSTRACT

Individuals enriched for familial longevity display a lower prevalence of age-related diseases, such as cardiovascular- and metabolic diseases. Since these diseases are associated with stress and increased cortisol levels, one of the underlying mechanisms that may contribute to healthy longevity might be a more adaptive response to stress. To investigate this, male middle-aged offspring from long-lived families (n=31) and male non-offspring (with no familial history of longevity) (n=26) were randomly allocated to the Trier Social Stress Test or a control condition in an experimental design. Physiological (cortisol, blood pressure, heart rate) and subjective responses were measured during the entire procedure. The results showed that Offspring had lower overall cortisol levels compared to Non-offspring regardless of condition, and lower absolute cortisol output (AUC<sub>G</sub>) during stress compared to Non-Offspring, while the increase (AUC<sub>I</sub>) did not differ between groups. In addition, systolic blood pressure in Offspring was lower compared to Non-offspring during the entire procedure. At baseline, Offspring had significantly lower systolic bloodpressure and reported less subjective stress than Non-offspring and showed a trend towards lower heart rate. Offspring from long-lived families might thus be less stressed prior to potentially stressful events and consequently show overall lower levels in physiological responses. Although attenuated physiological responding cannot be ruled out, lower starting points and a lower peak level in physiological responding when confronted with an actual stressor, might already limit damage due to stress over a lifetime. Lower physiological responding may also contribute to the lower prevalence of cardiovascular diseases and other stress-related diseases in healthy longevity.

## INTRODUCTION

With the expansion of the aging population, the prevalence of all major age related diseases is increasing. Studies investigating individuals who have the propensity to reach old age in good health are important to disentangle mechanisms that lead to healthy human longevity. For instance, individuals from long-lived families display lower prevalence of age-related diseases, such as cardiovascular and metabolic diseases(1-4). Since cardiovascular diseases, diabetes mellitus, metabolic syndrome have been associated with stress and increased cortisol levels(5-9), one of the underlying mechanisms that may contribute to healthy human familial longevity might be a more adaptive stress response.

Evidence from animal and human aging studies suggest that activity of the hypothalamic-pituitary-adrenal (HPA) axis contributes to biological aging, for instance through elevated cortisol release(10). Aging has been associated with increased basal cortisol levels(11-13), and high basal cortisol levels have been associated with e.g., physical frailty, insulin resistance, high blood pressure, impaired memory, which are all hallmarks of aging(5, 14-17). Interestingly, middle-aged individuals from long-lived families show lower basal HPA-activity(18), lower circulating glucose levels(3), increased insulin sensitivity(19), a lower prevalence of cardiovascular disease(4), metabolic syndrome(2) and mortality(1) than individuals who are not “enriched for longevity”. Therefore, one of the underlying mechanism of healthy longevity may be an altered HPA-axis reactivity.

With regard to HPA-axis reactivity in aging, older individuals generally respond with an increased cortisol response to pharmacological challenge compared to young individuals(20). Studies using psychological challenges, such as the Trier Social Stress Test (TSST), showed that stress-induced cortisol elevations in aged individuals were higher than in young individuals(20, 21), especially in male participants(22-26). Aging thus appears to be related to an increased salivary cortisol response to social stress, particularly in aged males.

Given that individuals enriched for familial longevity are thought to be biologically younger than age-matched peers(4), their physiological response to stress might be more reflective of that of younger individuals, with a lower cortisol response to stress. This lower stress responsiveness could be one of the underlying mechanisms of their healthy phenotype. To investigate this, we randomly allocated male offspring from long-lived families (“Offspring”), and males who did not meet our criteria for familial longevity (“Non-offspring”) to acute stress using the TSST or a non-stressful control condition in an experimental design. We hypothesized that offspring would respond with lower cortisol levels in response to social stress than their matched peers. As aging has been shown to be related to higher blood pressure (Bp) in response to challenges (e.g. cold water stress) than younger individuals(27, 28), we also expected

that offspring would respond with lower Bp to social stress than non-offspring. We had no clear expectation on the heart rate (HR) response to the TSST, given that findings on heart rate response to stress are contradictory(21, 23, 26-29).

## METHODS

### Participants

For the present study, 59 male volunteers who were eligible and willing to participate were included. Only males were included given the sex dependency of the cortisol response to stress in both the young(30, 31) and aged individuals, showing a significantly higher free salivary cortisol response to stress in aged men than in aged women (22-24). Participants were recruited via letters from the participant-pool of the Leiden Longevity Study (LLS). The LLS is a study consisting of 421 Caucasian families, enrolled between 2002 and 2006(1, 4). The LLS families comprise nonagenarians, their male or female offspring and the offspring's partners. Criteria for familial longevity are that at least 2 long-lived siblings are still alive and meet the age criteria of  $\geq 89$  yrs for men and  $\geq 91$  yrs for women. Only male volunteers from the LLS were screened for inclusion, half of them were included because their parents met the above described criteria for familial longevity (Offspring), the other half consisted of males whose parents did not meet the criteria for familial longevity (male Non-offspring, who are partners of female Offspring). Besides being male, other inclusion criteria were: being middle-aged (55-77 years) and having a stable body mass index (BMI) between  $19\text{kg/m}^2 < \text{BMI} < 33\text{kg/m}^2$ . The following exclusion criteria were used: the use of any hormone medication (including oral, nasal and inhalation corticosteroids) or having a current depression or other psychiatric disease influencing the HPA-axis as assessed with the MINI(32) and the Geriatric depression scale (GDS)(33). In addition, participants were excluded if their fasting plasma glucose was above 7 mmol/L, or if they had any significant chronic, renal, hepatic or endocrine disease, or if they used any medication known to influence lipolysis, thyroid function, glucose metabolism, GH/IGF-1 secretion or any other hormonal axis. Other exclusion criteria were smoking- and alcohol addiction, and extreme diet therapies. Based on the exclusion criteria, one male (Non-offspring) who scored  $> 11$  points on the 30 items geriatric depression scale (GDS-30), indicating a mild depression was excluded. In addition, 1 participant (Offspring) was excluded for analysis due to abnormally high saliva cortisol levels ( $> 92$  nmol/L). The final sample thus consisted of 57 male participants (31 Offspring and 26 Non-offspring). Upon inclusion, participants of each Group (Offspring vs Non-offspring) were randomly allocated to the Stress or Control condition in an experimental design.

**Table 1** Participant characteristics of Group (Offspring vs Non-offspring) by Condition (Control vs Stress)

	Offspring		Non-offspring	
	Control (n=15)	Stress (n=16)	Control (n=15)	Stress (n=11)
Age mother (yrs)	87.6 ± 11.2*	93.6 ± 4.7*	77.2 ± 17.8*	80.1 ± 15.1*
Age father (yrs)	88.7 ± 11.0*	81.6 ± 19.5*	74.8 ± 9.1*	71.3 ± 10*
Age (yrs)	67.1 ± 5.0	66.1 ± 8.3	67.1 ± 5.4	64.7 ± 3.3
BMI (kg/m <sup>2</sup> )	27.2 ± 4.0	26.6 ± 3.2	26.0 ± 3.1	25.9 ± 3.0
STAI trait	32.3 ± 5.9	28.8 ± 5.2	30.2 ± 6.3	28.8 ± 4.4
SCL-90	114.8 ± 12.2	109.4 ± 12	116.7 ± 14.7	115.4 ± 15.7
Cardiovascular disease (%)	2 (15)	1 (6.3)	3 (20)	1 (9.1)
Hypertension (%)	4 (26.7) <sup>a</sup>	3 (18.8) <sup>b</sup>	5 (33.3) <sup>c</sup>	2 (18.2) <sup>d</sup>

BMI = Body Mass Index; STAI-trait = Trait version of the State-trait anxiety inventory; SCL-90 = symptom checklist 90.

<sup>a</sup> 1 offspring used a combination of AT2-antagonist, β-blocker and diuretic; 1 offspring used a combination of diuretics, a calcium channel blocker and an ACE-inhibitor; 1 offspring used an ACE-inhibitor; 1 Offspring used diuretics;

<sup>b</sup> 1 Offspring used a combination of β-blocker, ACE-inhibitor and diuretics, 2 Offspring used a combination of β-blocker and diuretic;

<sup>c</sup> 1 Non-offspring used a combination of diuretics and ACE-inhibitor, 1 used a combination of diuretic, calcium channel blocker and AT2-antagonist, 3 used an AT2-antagonist;

<sup>d</sup> 1 non-offspring used a combination of diuretics and ACE-inhibitor; 1 used an ACE-inhibitor.

ACE-inhibitor = angiotensin-converting-enzyme inhibitor; AT2-antagonist= angiotensin 2 receptor antagonist;

\* = Offspring ≠ Non-offspring, *p* = .001

Means and standard deviations (*SDs*) of subject characteristics of the study population are presented in Table 1. As we selected the Offspring group on the age of the parents, both the age of the mother and father were significantly higher in the Offspring group compared to the Non-Offspring (Age mother:  $F(1, 57) = 11.97, p = .001$ ; Age father:  $F(1, 57) = 11.22, p = .001$ ). There were no differences between groups or condition in age, BMI, prevalence of cardiovascular disease or hypertension. Only in the Offspring group beta blockers were used in combination with other anti-hypertensive medication, whereas the Non-offspring used different types of anti-hypertensive medication without additional beta blockers. Mean total scores on psychoneuroticism (symptom checklist 90; SCL-90(34)) and trait anxiety (STAI(35)) were within the normal range according to norm scores for a healthy population.

The study was approved by the Medical Ethics Committee of the Leiden University Medical Centre and was performed according to the Helsinki declaration(36). All participants gave written informed consent before participation.

### **Stress-induction**

To induce psychological stress the Trier Social Stress Test (TSST) was used(37). This is a widely used laboratory protocol that reliably stimulates biomarkers of stress, and consists of a 10-min speech preparation period in anticipation of a 5-minute free speech and a 5-min arithmetic task (counting backwards from 1033 to zero, in steps of 13) performed in front of a selection committee of three alleged experts in non-verbal signs of stress, a camera and band recorder. During the arithmetic task, one committee member responded to incorrect answers by saying out loud “incorrect, please start again from 1033”, while keeping up the participants performance by means of a clearly visible score sheet.

In the control condition, participants used the same anticipation period of 10-min to prepare a speech about a book or movie of their own choice. Thereafter they had to speak out loud about this book or movie for 5 minutes followed by a 5 min period of arithmetics (counting backwards from 50 to zero at their own pace)(38). The presentation and arithmetics were performed in the same laboratory room as in the stress condition, but without an audience, camera or other recording devices.

### **Physiological assessments**

Salivary cortisol was assessed using Salivettes (Sarstedt, Nümbrecht, Germany). All saliva samples were immediately stored after the experiment at -20°C.

Systolic blood pressure (SBP, mmHg), diastolic blood pressure (DBP, mmHg) and heart rate (HR, bpm) were recorded using an automatic blood pressure monitor (OMRON, R5-I). BP and HR were measured in the same arm during the whole study period.

### **Subjective stress**

Subjective stress was measured using a visual analogue scale (VAS) score during the whole study period at the same time points when the physiological measurements were taken. Participants were asked to rate their current level of stress on a scale from 0 to 10, (“0” *not stressed at all*, to “10” *highly stressed*).

### **Procedure**

Screening. Volunteers first underwent a standardized screening by telephone. Participants were asked about their present medication use and medical history, and the given information was then checked with data records obtained from the pharmacy and general practitioner (see Table 1 for medication use). Past and present

psychiatric symptoms were also assessed using a shortened version of the MINI international neuropsychiatric interview (MINI)(32).

Experiment. All participants started the stress or control procedure at 08.00h, or at 09.15h. The timing of stress and control condition were balanced over participants, to reduce variation in morning cortisol levels due to differences in clock time as much as possible between groups. Participants were asked to refrain from taking medication, eating and drinking caffeine-, sugar- or alcohol-containing beverages starting at 22.00h the evening before the experiment. After arrival, participants were seated in a quiet room where information was given about the study day and written informed consent was obtained. Next, each participant was brought to the dressing room to change into the obligatory hospital clothing. Subsequently the TSST protocol started with instructions (i.e., to prepare a presentation). Saliva samples were obtained at four times: immediately before TSST instructions (T0 "baseline"), after the preparation phase of the TSST (T1 "pre-speech"), at the end of the TSST (T2 "post-TSST"), and 50 minutes later (T3 "post-experiment"). Between the last two samples, tasks were performed inside a MRI-scanner (to be published elsewhere). Blood pressure, heart rate and subjective stress were sampled at the four sample time points. After the final sample time point, participants were administered questionnaires and weight and height were measured using the same weighing scale and height meter for all participant. Thereafter participants continued with a protocol unrelated to the present experiment.

### Chemical analysis

All saliva cortisol samples were assayed at Professor Kirschbaum`s laboratory (<http://biopsychologie.tu-dresde.de>). Cortisol concentrations in saliva were measured using a commercially available chemiluminescence-immunoassay kit with high sensitivity (IBL, Hamburg, Germany). Inter-and intra-assay coefficients of variation were below 10%.

### Data analysis

Raw cortisol levels, SBP, DBP and heart rate measurements were checked for outliers. Outliers were defined as values beyond 3 standard deviations (*SD*) below or above the mean and were replaced by the mean plus 3 *SD*s. Missing cortisol values, due to limited amount of saliva, were replaced by the mean per group (Stress vs Control). The dependent variables cortisol, BP, HR and subjective measurements of stress were analyzed using repeated measures (RM) ANOVAs, with Group (Offspring/ Non-offspring) and Condition (Stress/No-Stress) as between-subjects factors and Time (T0-T3) as within-subject factors and followed up by *t*-tests. Greenhouse-Geisser corrections were applied when appropriate.

For analyses the Statistical Package for the Social Sciences program for Windows, version 20 (SPSS, Chicago, IL) was used.  $p < .05$  was considered statistically significant.

## RESULTS

### Cortisol

A RM-ANOVA was performed with Group (Offspring vs. Non-offspring) and Condition (Control vs. Stress) as between-subjects factors and Time (T0, T1, T2, T3) as within-subject factor, and cortisol levels as dependent variable. There was a significant effect of Time ( $F[2.25; 119.46] = 4.15, p = .02, \eta^2 = 0.07$ ), and Condition ( $F(1, 53) = 5.93, p = .02, \eta^2 = 0.101$ ), with higher cortisol levels in the Stress condition ( $M \pm SE: 15.8 \pm 1.0$ ) compared to the Control condition ( $M \pm SE: 12.4 \pm 0.9$ ), and a significant Condition by Time interaction ( $F(3, 159) = 4.06, p = .008, \eta^2 = 0.07$ ), showing that the stress manipulation was successful with no difference between Stress and Control at baseline (T0) ( $t_{55} = -0.13, p = .89$ ) or after the preparation phase (T1) ( $t_{55} = -1.47, p = .15$ ), and significantly higher cortisol levels in the Stress- than in the Control condition immediately after the TSST (T2) ( $t_{55} = 2.25, p = .03$ ), and 50 minutes after the TSST (T3) ( $t_{55} = 2.31, p = .03$ ) (see Figure 1).

In addition, there was a significant between-subjects effect of Group ( $F[1, 53] = 5.52, p = .02, \eta^2 = 0.094$ ), indicating that overall mean cortisol levels, regardless of Condition, were lower in Offspring ( $M \pm SE: 12.5 \pm 0.9$ ) than in Non-offspring ( $M \pm SE: 15.7 \pm 1.0$ ) (see Figure 2A). There was no Group by Time interaction ( $F[3, 159] = 1.37,$

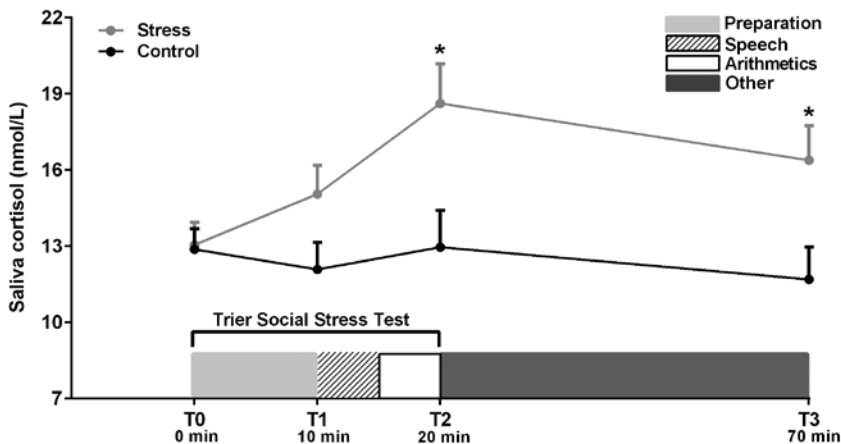

**Figure 1** Mean saliva cortisol levels and standard error in the Stress- and in the Control condition

Cortisol levels rise significantly in response to the Trier Social Stress Test in the stress condition compared to the control condition. \* $p \leq .05$



$p = .25$ ), but there was a significant quadratic contrast of Group by Time ( $F[1, 53] = 5.84, p = .019, \eta^2 = 0.099$ ). Follow-up  $t$ -tests showed that there was no difference between Offspring ( $M \pm SE = 11.97 \pm 0.77$ ) and Non-Offspring ( $M \pm SE = 13.81 \pm 0.93$ ) at T0 ( $t_{55} = 1.55, p = .13$ ), a significantly lower mean cortisol in Offspring than in Non-Offspring ( $M \pm SE$ , Offspring =  $11.45 \pm 0.77$ ; Non-Offspring =  $15.34 \pm 1.47$ ) after the anticipation phase, T1 ( $t_{38,18} = 2.35, p = .024$ , equal variances not assumed) and a trend towards lower cortisol levels at T2 in Offspring ( $M \pm SE = 13.52 \pm 1.45$ ) compared to Non-offspring ( $M \pm SE = 17.43 \pm 1.73$ ) ( $t_{55} = 1.75, p = .086$ ). Finally, there was no significant Group by Condition interaction ( $F(1, 53) = 2.46, p = .12, \eta^2 = 0.044$ ) and no three-way interaction between Group, Condition and Time ( $F[3, 159] = 0.30, p = .83$ ).

A univariate ANOVA with baseline cortisol level as dependent variable showed that cortisol levels at baseline were not significantly different between Groups ( $F[1, 56] = 2.65, p = .11$ ) or Condition ( $F[1, 56] = 0.02, p = .89$ ). There was also no Group by Condition interaction at baseline ( $F[1, 56] = 1.89, p = .18$ ), which suggested that overall lower mean cortisol levels in the Offspring group were not indicative of pre-existing differences, but of lower responses to stress over time (see figure 3). We therefore additionally calculated the area under the curve with respect to the ground ( $AUC_g$ ) to assess the differences in total cortisol output between the groups, and the area under the curve with respect to increase ( $AUC_i$ ), to assess the differences in the rate of change (39). An ANOVA with Group as fixed factor and  $AUC_g$  as dependent variable showed that under control conditions,  $AUC_g$  did not differ between groups ( $F[1, 30] = 0.61, p = .44$ ), nor did the  $AUC_i$  differ between groups ( $F[1, 30] = 0.09, p = .76$ ). In the stress condition, Offspring had a significantly smaller  $AUC_g$  in comparison to the non-Offspring ( $F[1, 27] = 5.37, p = .029, \eta^2 = 0.177$ ), but there was no difference in  $AUC_i$  ( $F[1, 27] = 0.86, p = .36$ ).

### Heart rate

The RM-ANOVA with heart rate (HR) as dependent variable showed an effect of Condition at trend levels ( $F[1, 51] = 3.11, p = .08, \eta^2 = 0.058$ ), with slightly higher HR in the Stress condition ( $M \pm SE: 67.9 \pm 1.8$ ) compared to the Control condition ( $M \pm SE: 63.7 \pm 1.6$ ), no effect of Time,  $F(3, 153) = 1.93, p = .13$ , but a significant Condition by Time interaction ( $F[3, 153] = 10.11, p < .0005, \eta^2 = 0.165$ ). Follow-up  $t$ -tests showed that at baseline (T0) ( $t_{54} = -1.11, p = .91$ ), and at T1 ( $t_{42,8} = 0.71, p = .48$ ), there were no differences between the groups. Directly after stress (T2) participants in the Stress condition had significantly higher HR compared to the Control condition ( $t_{37,6} = 2.42, p = .02$ ), and no differences 50 minutes after the TSST (T3) ( $t_{53} = 0.79, p = .43$ ). Only right after the TSST (T2), HR was significantly higher in the Stress condition ( $M \pm SE: 69.3 \pm 2.6$ ) compared to the Control condition ( $M \pm SE: 62.1 \pm 1.4, t_{37,6} = 2.42, p = .02$ ). There was a significant between-subjects effect of Group  $F(1, 51) = 4.58,$

$p = .037$ ,  $\eta^2 = 0.082$ , with lower overall HR in Offspring ( $M \pm SE: 63.3 \pm 1.6$ ) compared to the Non-offspring ( $M \pm SE: 68.3 \pm 1.8$ ). There was no significant Group by Time interaction ( $F[3, 153] = 0.93$ ,  $p = .43$ ), no Group by Condition interaction ( $F(1, 51) = 0.72$ ,  $p = .40$ ) and no significant three-way interaction between Group, Condition and Time ( $F(3, 153) = 1.02$ ,  $p = .39$ ).

Univariate ANOVA's showed that HR at baseline was lower in the Offspring group ( $M \pm SE: 62.3 \pm 1.6$ ) compared to the Non-offspring group ( $M \pm SE: 67.8 \pm 1.8$ ) ( $F[1, 56] = 4.75$ ,  $p = .034$ ,  $\eta^2 = 0.081$ ), but there were no other pre-stress differences in HR (Condition: ( $F[1, 56] = 0.012$ ,  $p = .91$ ); Group by Condition: ( $F[1, 56] = 1.06$ ,  $p = .31$ ,  $\eta^2 = 0.020$ ).

## Blood pressure

*Systolic blood pressure (SBP)*. The RM ANOVA with SBP as dependent variable showed a significant between-subjects effect of Condition ( $F(1, 51) = 7.52$ ,  $p = .008$ ,  $\eta^2 = 0.128$ , with higher mean SBP in the stress condition ( $M \pm SE: 162 \pm 2.8$ ) compared

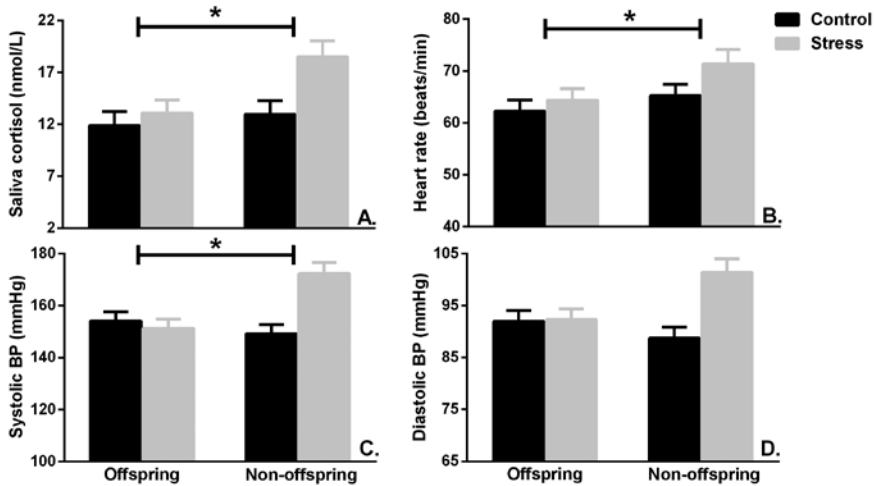

**Figure 2** Overall mean physiological responses of Group (Offspring vs Non-offspring) by Condition (Control vs Stress)

Mean cortisol, heart rate and systolic blood pressure are significantly lower in Offspring compared to Non-offspring during the experiment regardless of stress or control condition.

A. Cortisol; B. Heart rate; C. Systolic blood pressure; D. Diastolic blood pressure.

Error bars represent the standard error of the mean.

\* = Significant difference between Offspring and Non-offspring: cortisol ( $p = .02$ ), heart rate ( $p = .037$ ) and systolic blood pressure ( $p = .03$ ).

to the control condition ( $M \pm SE: 152 \pm 2.5$ ). We found a significant effect of Time,  $F(2.38; 121.46) = 3.27, p = .03, \eta^2 = 0.06$ , and a significant Condition by Time interaction  $F(3, 153) = 7.92, p < .0005, \eta^2 = 0.134$ . Follow-up  $t$ -tests showed no difference between Stress and Control condition, before the start of the TSST, at baseline (T0) ( $t_{54} = 0.63, p = .53$ ) and at T1 ( $t_{42.1} = 1.43, p = .16$ ), while right after the TSST (T2), SBP was significantly higher in the Stress- compared to the Control condition ( $t_{54} = 4.13, p < .0005$ ), a difference that had disappeared 50 minutes after TSST ( $t_{39.7} = 0.64, p = .52$ ).

There was a significant between-subjects effect of Group  $F(1, 51) = 4.72, p = .03, \eta^2 = 0.085$  with lower mean SBP in Offspring ( $M \pm SE: 153 \pm 2.5$ ) compared to Non-offspring ( $M \pm SE: 161 \pm 2.9$ ). There was no significant Group by Time interaction  $F(3, 153) = 0.81, p = .49$ , and no significant three-way interaction between Group, Condition and Time ( $F[3, 153] = 0.85, p = .47$ ). There was, however, a significant Group by Condition interaction  $F(1, 51) = 12.18, p = .001, \eta^2 = 0.193$ . Follow-up  $t$ -tests showed that during the Control condition Offspring and Non-offspring did not differ in SBP ( $t_{28} = 1.10, p = .28$ ), whereas in the stress condition Non-Offspring had significantly higher mean SBP than Offspring ( $t_{24} = -3.60, p = .001$ ) (see Figure 3C). However, although SBP at baseline did not differ between Offspring ( $M \pm SE: 153.6 \pm 3.3$ ) and Non-offspring ( $M \pm SE: 160.1 \pm 3.7, F[1, 56] = 1.71, p = .20$ ), and also not between Control ( $M \pm SE: 155 \pm 3.4$ ) and Stress condition ( $M \pm SE: 158 \pm 3.7$ ) ( $F(1, 56) = 0.40, p = .53$ ), an interaction of Condition by Group showed that the Non-Offspring in the stress condition already had higher SBP at baseline ( $F[1, 56] = 4.59, p = .037, \eta^2 = 0.081$ ). To check whether the significant RM ANOVA Condition by Group interaction was driven by pre-stress baseline differences, we calculated difference scores by subtracting baseline (T0) mean from T1, T2 and T3. A RM ANOVA performed with these new variables showed that the Condition by Group interaction was not significant when taking these baseline differences into account ( $F[1, 51] = 1.15, p = .29$ ).

*Diastolic blood pressure (DBP)*. The RM ANOVA with DBP as dependent variable showed a significant between-subjects effect of Condition  $F(1, 51) = 8.27, p = .006, \eta^2 = 0.140$ , with higher mean DBP in the stress condition ( $M \pm SE: 96.8 \pm 1.7$ ) compared to the control condition ( $M \pm SE: 90.3 \pm 1.5$ ), but no significant within-subjects effect of Time ( $F[3, 153] = 1.08, p = .36$ ) and a trend for a Condition by Time interaction ( $F[3, 153] = 2.53, p = .06$ ).

There was no significant between-subjects effect of Group  $F(1, 51) = 1.71, p = .20$ , no Group by Time interaction  $F(3, 153) = 1.06, p = .37$ , and no three-way interaction between Group, Condition and Time  $F(3, 153) = 0.28, p = .84$ . However, there was a significant Group by Condition interaction  $F(1, 51) = 7.48, p = .009, \eta^2 = 0.128$ , showing a similar pattern to SBP (see Figure 3D), with significantly higher mean DBP in the Stress condition in the Non-offspring compared to the Offspring ( $t_{24} = -2.90, p = .008$ ), and no differences between Offspring and Non-offspring in the Control

condition ( $t_{28} = 1.08, p = .29$ ). However, again, to check whether baseline differences were not driving this interaction, we ran a univariate ANOVA on the baseline means. DBP at baseline did not differ between Offspring ( $M \pm SE: 92.7 \pm 1.56$ ) and Non-offspring ( $M \pm SE: 93.6 \pm 1.77, F(1, 56) = 0.15, p = .69$ ), and also not between Control ( $M \pm SE: 91.4 \pm 1.58$ ) and Stress condition ( $M \pm SE: 94.9 \pm 1.75$ ) ( $F[1, 56] = 2.23, p = .14$ ), but an interaction of Condition by Group showed that the Non-Offspring in the stress condition already had higher DBP at baseline ( $F[1, 56] = 4.60, p = .037, = 0.081$ ). To investigate whether the overall Condition by Group interaction would still stand when baseline was taken into account, another RM ANOVA was performed with difference scores, which showed that the interaction was not significant anymore ( $F[1, 51] = 0.69, p = .41$ ).

**Subjective stress**

The RM ANOVA with VAS-scores of subjective stress as dependent variable showed a significant effect of Time ( $F[2.60; 132.38] = 10.96, p < .0005, = 0.177$ ), a significant between-subjects effect of Condition  $F(1, 51) = 4.00, p = .05, = 0.073$ , with higher VAS score in the Stress condition ( $M \pm SE: 3.2 \pm 0.3$ ) compared to the Control condition ( $M \pm SE: 2.3 \pm 0.3$ ), and a significant Condition by Time interaction  $F(3, 153) = 7.43, p < .0005, = 0.127$ . Follow-up  $t$ -tests showed that there was a significant

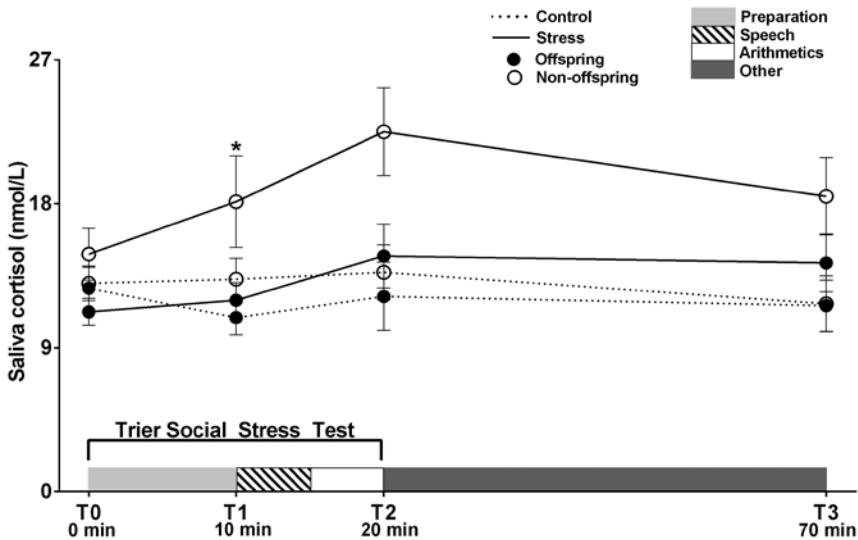

**Figure 3** Mean cortisol levels on all time points in Offspring and Non-Offspring in the Control and Stress condition.

rise in VAS-scores due to the TSST in the Stress condition. At baseline (T0) ( $t_{54} = -0.80$ ,  $p = .43$ ) and at T1 ( $t_{54} = 0.71$ ,  $p = .48$ ) mean VAS-scores did not differ between the Stress and Control condition, while mean VAS-scores right after the TSST (T2) ( $t_{54} = 3.13$ ,  $p = .003$ ) and 50 minutes after TSST (T3) ( $t_{53} = 2.4$ ,  $p = .02$ ) were significantly higher in the Stress condition than in the Control condition. There was no between-subjects effect of Group  $F(1, 51) = 0.92$ ,  $p = .34$ , no Group by Time interaction  $F(3, 153) = 2.10$ ,  $p = .10$ , no three-way interaction between Group, Condition and Time  $F(3, 153) = 0.34$ ,  $p = .80$ , and no Group by Condition interaction  $F(1, 51) = 0.52$ ,  $p = .48$ .

A univariate ANOVA showed that Offspring ( $M \pm SE: 1.6 \pm 0.3$ ) initially had lower VAS-scores at baseline than Non-offspring ( $M \pm SE: 2.8 \pm 0.3$ ) ( $F[1, 56] = 7.39$ ,  $p = .009$ ,  $\eta^2 = 0.124$ ), but there were no differences between groups at all other time points in VAS assessments (see supplementary Table 1 for means and SDs at all time points).

### Analyses without beta blocker users

Although the participants were fasted from 22h the day before and did not take their standard medication the morning of the experiment, the lower baseline HR in the Offspring might have been caused by beta blocker users (3 Offspring in the Stress- and 1 Offspring in the Control condition). Beta blockers are known to interfere with the sympathetic nervous system and the HPA-axis stress response, by decreasing adrenergic indices such as HR and Bp, and increasing cortisol levels(40-42). When the analyses were rerun without the 4 beta blocker users, the Group difference in HR at baseline was only a trend ( $F(1, 52) = 3.43$ ,  $p = .07$ ) and the RM ANOVA between-subjects effect of Group was not significant anymore ( $F[1, 47] = 2.58$ ,  $p = .12$ ). Exclusion of the beta blocker users, however, did not significantly change the results on cortisol or Bp (see Supplementary material for the analyses without the 4 beta blocker users).

## DISCUSSION

Because physiological responses to stress, in particular increases in cortisol and blood pressure, have shown to increase with age(20-23, 27, 28), it was hypothesized that individuals who come from long-lived families would display attenuated physiological responses to stress compared to individuals who do not come from long-lived families. To investigate this, we exposed middle-aged males from long-lived families ("offspring") and age-matched controls ("non-offspring") to acute social stress using the TSST or a non-stressful condition. The stress manipulation increased cortisol, heart rate (HR), blood pressure (Bp) and subjective stress. However, during the entire procedure offspring had lower cortisol levels and systolic blood pressure

compared to non-offspring. Although the relative cortisol *increase* between groups did not differ, offspring had smaller absolute overall cortisol output in response to stress compared to non-offspring, specifically during stress anticipation.

Finding lower overall cortisol levels in offspring is consistent with earlier studies showing a tendency towards lower cortisol levels in offspring from long-lived families in the cortisol awakening response and in evening cortisol levels(18). In times of stress, cortisol levels may increase at the same rate in offspring as in non-offspring, however, the net result would be a lower lifetime exposure to cortisol. Given the strong associations between, for instance, cortisol exposure and declining cognitive function(43, 44), one of the consequences of lower exposure to cortisol could be a better maintained cognitive function, as was previously found in middle-aged offspring(45). It may be too soon, however, to conclude that offspring do not respond with attenuated cortisol to stress. First, baseline cortisol levels in offspring were not significantly lower than those of the non-offspring before stress was induced, although they were slightly lower on a descriptive level. This suggests that the overall lower cortisol levels in offspring were not specifically due to pre-existing lower cortisol levels, but - at least partly - a consequence of a smaller cortisol response to stress. Indeed, the area under the curve with respect to the ground showed significantly smaller absolute cortisol output in offspring only during stress, but not during the control condition. Because the magnitude, or relative rise, in stress-induced cortisol levels did not differ significantly between offspring and non-offspring, our results point at the importance of subtle – non-significant- baseline differences in cortisol level. Furthermore, individual differences may have prevented finding a robust attenuated cortisol response to stress in offspring, as some individuals within this group did respond with high cortisol to stress. As longevity is an inheritable phenotype, not every offspring from long-lived siblings may be enriched with familial longevity. Finally, the effect size of the interaction was between small and medium, which, together with our small sample size, indicates that the chance of a Type 2 error is not negligible. In sum, on the basis of the current results we cannot exclude the possibility that offspring actually do have an attenuated cortisol response to stress.

Similar to cortisol, systolic Bp (but not diastolic Bp) was lower in offspring than in non-offspring throughout the entire procedure, also when taking beta blocker use into account. Although Bp appeared to be specifically attenuated due to stress in the offspring, this was not the case. Regretfully, the non-offspring in the stress condition already had significantly higher Bp compared to all others, regardless of group or condition, before the stress procedure had even started. This was despite random allocation, and despite the fact that both experimenters and stress committee were blind to the offspring or non-offspring status of the participants. Still, an overall lower Bp, with a standard rise due to stress, would consistently lead to less pressure on the arteries compared to individuals with higher overall Bp. A Bp response with lower

peaks to life's stressors reduces atherosclerotic risk factors and might thus be an important protective factor with regard to the development of cardiovascular disease(46-49). Whether offspring actually has an attenuated response to stress, apart from a lower general baseline, should be studied in preferably a larger group than used in the present study to minimize unfortunate Bp distributions.

HR was also lower in offspring during the entire procedure compared to non-offspring, and the relative HR increase in response to stress did not appear to be attenuated. We, however, did not have a clear hypothesis on HR response after psychological stress, due to the inconsistent and limited amount of literature in relation to ageing(21, 23, 29), and when taking beta blocker use into account, this effect was abolished. Still, baseline heart rate tended to be lower in offspring. As lower HR at rest is associated with longer lifespan across all species(50), lower HR in offspring may be a reflection of their longevity phenotype, however, this should be investigated in a larger sample.

With regard to subjective stress, offspring were significantly more relaxed than non-offspring in the run-up to participating in the experiment but as apprehensive as non-offspring during the stress experiment itself. In addition, offspring responded with lower cortisol than non-offspring, specifically after the anticipation phase of the procedure. Maybe offspring from long-lived families have less anticipatory stress, subjectively and physiologically, prior to stressful events because they worry less. Worry in anticipation of what might be stressful in the near future and ruminations prior to actual stressful events are related to enhanced activation of cardiovascular, immune, endocrine and neurovisceral systems(51), which might contribute to diseases related to these systems(52).

A limitation of this study is the family-based study recruitment strategy. Although we selected both groups on the age of the parents, the non-offspring may also become long-lived, whereas the offspring group may very well consist of some individuals who will not live up to a high age. This might explain the individual differences in responses, such as a few offspring with a high cortisol response to stress or non-offspring with low cortisol response to stress. Another limitation of this study was the medication use of the aged participants, although these are commonly prescribed in this age category. Apart from beta blockers, that were used by 4 offspring, the use of anti-hypertensive medication was comparable between groups. All participants were fasted from 22h the day before and thus did not take their standard medication the evening before, and morning of the experiment. Another limitation was our small sample size. Given the small to medium effect sizes, this study was probably underpowered. Finally, this study cannot be generalized to females and conclusions are thus limited to males.

In sum, male offspring from long-lived families compared to male non-offspring feel less stressed before encountering a potentially stressful situation, and have

overall lower cortisol and systolic Bp compared to non-offspring during the entire event, whether it was stressful or not. Consequently, offspring reach lower peak physiological levels than non-offspring regardless of the situation they find themselves in. Offspring might actually have an attenuated physiological response to stress, as we did find indications of reduced responding to stress, such as a lower total cortisol output. As psychological stress in daily life is common up to a high age, lower physiological output may delay the onset of cardiovascular disease, and cognitive deterioration, and might therefore contribute to a healthy long-living phenotype.



## REFERENCES

1. Schoenmaker M, de Craen AJ, de Meijer PH, Beekman M, Blauw GJ, Slagboom PE, and Westendorp RG. Evidence of genetic enrichment for exceptional survival using a family approach: the Leiden Longevity Study. *Eur J Hum Genet.* 2006;14(1):79-84.
2. Rozing MP, Westendorp RG, de Craen AJ, Frolich M, de Goeij MC, Heijmans BT, Beekman M, Wijsman CA, Mooijaart SP, Blauw GJ, Slagboom PE, van Heemst D, and Leiden Longevity Study G. Favorable glucose tolerance and lower prevalence of metabolic syndrome in offspring without diabetes mellitus of nonagenarian siblings: the Leiden longevity study. *J Am Geriatr Soc.* 2010;58(3):564-9.
3. Rozing MP, Westendorp RG, Frolich M, de Craen AJ, Beekman M, Heijmans BT, Mooijaart SP, Blauw GJ, Slagboom PE, van Heemst D, and Leiden Longevity Study G. Human insulin/IGF-1 and familial longevity at middle age. *Aging (Albany NY).* 2009;1(8):714-22.
4. Westendorp RG, van Heemst D, Rozing MP, Frolich M, Mooijaart SP, Blauw GJ, Beekman M, Heijmans BT, de Craen AJ, Slagboom PE, and Leiden Longevity Study G. Nonagenarian siblings and their offspring display lower risk of mortality and morbidity than sporadic nonagenarians: The Leiden Longevity Study. *J Am Geriatr Soc.* 2009;57(9):1634-7.
5. Wallerius S, Rosmond R, Ljung T, Holm G, and Bjorntorp P. Rise in morning saliva cortisol is associated with abdominal obesity in men: a preliminary report. *J Endocrinol Invest.* 2003;26(7):616-9.
6. Seeman T, Epel E, Gruenewald T, Karlamangla A, and McEwen BS. Socio-economic differentials in peripheral biology: cumulative allostatic load. *Ann N Y Acad Sci.* 2010;1186(223-39).
7. Champaneri S, Xu X, Carnethon MR, Bertoni AG, Seeman T, Diez Roux A, and Golden SH. Diurnal salivary cortisol and urinary catecholamines are associated with diabetes mellitus: the Multi-Ethnic Study of Atherosclerosis. *Metabolism.* 2012;61(7):986-95.
8. Cohen S, Janicki-Deverts D, and Miller GE. Psychological stress and disease. *JAMA.* 2007;298(14):1685-7.
9. Rosmond R. Role of stress in the pathogenesis of the metabolic syndrome. *Psychoneuroendocrinology.* 2005;30(1):1-10.
10. Aguilera G. HPA axis responsiveness to stress: implications for healthy aging. *Exp Gerontol.* 2011;46(2-3):90-5.
11. Van Cauter E, Leproult R, and Kupfer DJ. Effects of gender and age on the levels and circadian rhythmicity of plasma cortisol. *J Clin Endocrinol Metab.* 1996;81(7):2468-73.
12. Nater UM, Hoppmann CA, and Scott SB. Diurnal profiles of salivary cortisol and alpha-amylase change across the adult lifespan: evidence from repeated daily life assessments. *Psychoneuroendocrinology.* 2013;38(12):3167-71.
13. Deuschle M, Gotthardt U, Schweiger U, Weber B, Korner A, Schmider J, Standhardt H, Lammers CH, and Heuser I. With aging in humans the activity of the hypothalamus-pituitary-adrenal system increases and its diurnal amplitude flattens. *Life Sci.* 1997;61(22):2239-46.
14. Lupien SJ, de Leon M, de Santi S, Convit A, Tarshish C, Nair NP, Thakur M, McEwen BS, Hauger RL, and Meaney MJ. Cortisol levels during human aging predict hippocampal atrophy and memory deficits. *Nat Neurosci.* 1998;1(1):69-73.
15. Kumari M, Badrick E, Sacker A, Kirschbaum C, Marmot M, and Chandola T. Identifying patterns in cortisol secretion in an older population. Findings from the Whitehall II study. *Psychoneuroendocrinology.* 2010;35(7):1091-9.
16. Chrousos GP. The role of stress and the hypothalamic-pituitary-adrenal axis in the pathogenesis of the metabolic syndrome: neuro-endocrine and target tissue-related causes. *Int J Obes Relat Metab Disord.* 2000;24 Suppl 2(S50-5).
17. Parker KJ, Schatzberg AF, and Lyons DM. Neuroendocrine aspects of hypercortisolism in major depression. *Horm Behav.* 2003;43(1):60-6.
18. Noordam R, Jansen SW, Akintola AA, Oei NY, Maier AB, Pijl H, Slagboom PE, Westendorp RG, van der Grond J, de Craen AJ, van Heemst D, and Leiden Longevity Study g. Familial longevity is marked by lower diurnal salivary cortisol levels: the Leiden Longevity Study. *PLoS One.* 2012;7(2):e31166.

19. **Wijsman CA, Rozing MP, Streefland TC, le Cessie S, Mooijaart SP, Slagboom PE, Westendorp RG, Pijl H, van Heemst D, and Leiden Longevity Study g.** Familial longevity is marked by enhanced insulin sensitivity. *Aging Cell*. 2011;10(1):114-21.
20. **Otte C, Hart S, Neylan TC, Marmar CR, Yaffe K, and Mohr DC.** A meta-analysis of cortisol response to challenge in human aging: importance of gender. *Psychoneuroendocrinology*. 2005;30(1):80-91.
21. **Almela M, Hidalgo V, Villada C, van der Meij L, Espin L, Gomez-Amor J, and Salvador A.** Salivary alpha-amylase response to acute psychosocial stress: the impact of age. *Biol Psychol*. 2011;87(3):421-9.
22. **Kudielka BM, Buske-Kirschbaum A, Hellhammer DH, and Kirschbaum C.** HPA axis responses to laboratory psychosocial stress in healthy elderly adults, younger adults, and children: impact of age and gender. *Psychoneuroendocrinology*. 2004;29(1):83-98.
23. **Strahler J, Mueller A, Rosenloecher F, Kirschbaum C, and Rohleder N.** Salivary alpha-amylase stress reactivity across different age groups. *Psychophysiology*. 2010;47(3):587-95.
24. **Hidalgo V, Almela M, Villada C, and Salvador A.** Acute stress impairs recall after interference in older people, but not in young people. *Horm Behav*. 2014;65(3):264-72.
25. **Rohleder N, Kudielka BM, Hellhammer DH, Wolf JM, and Kirschbaum C.** Age and sex steroid-related changes in glucocorticoid sensitivity of pro-inflammatory cytokine production after psychosocial stress. *J Neuroimmunol*. 2002;126(1-2):69-77.
26. **Kudielka BM, Schmidt-Reinwald AK, Hellhammer DH, Schurmeyer T, and Kirschbaum C.** Psychosocial stress and HPA functioning: no evidence for a reduced resilience in healthy elderly men. *Stress*. 2000;3(3):229-40.
27. **Hess KL, Wilson TE, Sauder CL, Gao Z, Ray CA, and Monahan KD.** Aging affects the cardiovascular responses to cold stress in humans. *J Appl Physiol (1985)*. 2009;107(4):1076-82.
28. **Uchino BN, Birmingham W, and Berg CA.** Are older adults less or more physiologically reactive? A meta-analysis of age-related differences in cardiovascular reactivity to laboratory tasks. *J Gerontol B Psychol Sci Soc Sci*. 2010;65B(2):154-62.
29. **Kudielka BM, Buske-Kirschbaum A, Hellhammer DH, and Kirschbaum C.** Differential heart rate reactivity and recovery after psychosocial stress (TSST) in healthy children, younger adults, and elderly adults: the impact of age and gender. *Int J Behav Med*. 2004;11(2):116-21.
30. **Kudielka BM, Hellhammer J, Hellhammer DH, Wolf OT, Pirke KM, Varadi E, Pilz J, and Kirschbaum C.** Sex differences in endocrine and psychological responses to psychosocial stress in healthy elderly subjects and the impact of a 2-week dehydroepiandrosterone treatment. *J Clin Endocrinol Metab*. 1998;83(5):1756-61.
31. **Kirschbaum C, Kudielka BM, Gaab J, Schommer NC, and Hellhammer DH.** Impact of gender, menstrual cycle phase, and oral contraceptives on the activity of the hypothalamus-pituitary-adrenal axis. *Psychosom Med*. 1999;61(2):154-62.
32. **Sheehan DV, Lecrubier Y, Sheehan KH, Amorim P, Janavs J, Weiller E, Hergueta T, Baker R, and Dunbar GC.** The Mini-International Neuropsychiatric Interview (M.I.N.I.): the development and validation of a structured diagnostic psychiatric interview for DSM-IV and ICD-10. *J Clin Psychiatry*. 1998;59 Suppl 20(22-33):quiz 4-57.
33. **Yesavage JA, Brink TL, Rose TL, Lum O, Huang V, Adey M, and Leirer VO.** Development and validation of a geriatric depression screening scale: a preliminary report. *J Psychiatr Res*. 1982;17(1):37-49.
34. **W. A. Arrindell JHME. SCL-90. Handleiding bij Multidimensionele Psychopathologie-Indicator.** Lisse: Swets & Zeitlinger B.V. ; 1986.
35. **Spielberger CD. Manual for the State-Trait Anxiety Inventory (STAI).** Palo Alto, CA: Consulting Psychologists; 1983.
36. **Helsinki Do.** 52nd WMA General Assembly. *Declaration of Helsinki: Edinburgh, UK*. 2000.
37. **Kirschbaum C, Pirke KM, and Hellhammer DH.** The 'Trier Social Stress Test'--a tool for investigating psychobiological stress responses in a laboratory setting. *Neuropsychobiology*. 1993;28(1-2):76-81.
38. **Het S, Rohleder N, Schoofs D, Kirschbaum C, and Wolf OT.** Neuroendocrine and psychometric evaluation of a placebo version of the 'Trier Social Stress Test'. *Psychoneuroendocrinology*. 2009;34(7):1075-86.

39. **Pruessner JC, Kirschbaum C, Meinischmid G, and Hellhammer DH.** Two formulas for computation of the area under the curve represent measures of total hormone concentration versus time-dependent change. *Psychoneuroendocrinology*. 2003;28(7):916-31.
40. **Maheu FS, Joober R, and Lupien SJ.** Declarative memory after stress in humans: differential involvement of the beta-adrenergic and corticosteroid systems. *J Clin Endocrinol Metab*. 2005;90(3):1697-704.
41. **Simeckova M, Jansky L, Lesna II, Vybiral S, and Sramek P.** Role of beta adrenoreceptors in metabolic and cardiovascular responses of cold exposed humans. *J Therm Biol*. 2000;25(6):437-42.
42. **Oei NY, Tollenaar MS, Elzinga BM, and Spinhoven P.** Propranolol reduces emotional distraction in working memory: a partial mediating role of propranolol-induced cortisol increases? *Neurobiol Learn Mem*. 2010;93(3):388-95.
43. **Lupien S, Lecours AR, Lussier I, Schwartz G, Nair NP, and Meaney MJ.** Basal cortisol levels and cognitive deficits in human aging. *J Neurosci*. 1994;14(5 Pt 1):2893-903.
44. **Lupien SJ, Nair NP, Briere S, Maheu F, Tu MT, Lemay M, McEwen BS, and Meaney MJ.** Increased cortisol levels and impaired cognition in human aging: implication for depression and dementia in later life. *Rev Neurosci*. 1999;10(2):117-39.
45. **Stijntjes M, de Craen AJ, van Heemst D, Meskers CG, van Buchem MA, Westendorp RG, Slagboom PE, and Maier AB.** Familial longevity is marked by better cognitive performance at middle age: the Leiden Longevity Study. *PLoS One*. 2013;8(3):e57962.
46. **Kaplan JR, Pettersson K, Manuck SB, and Olsson G.** Role of sympathoadrenal medullary activation in the initiation and progression of atherosclerosis. *Circulation*. 1991;84(6 Suppl):VI23-32.
47. **McEwen BS, and Tucker P.** Critical biological pathways for chronic psychosocial stress and research opportunities to advance the consideration of stress in chemical risk assessment. *Am J Public Health*. 2011;101 Suppl 1(S131-9).
48. **Everson SA, Lynch JW, Chesney MA, Kaplan GA, Goldberg DE, Shade SB, Cohen RD, Salonen R, and Salonen JT.** Interaction of workplace demands and cardiovascular reactivity in progression of carotid atherosclerosis: population based study. *BMJ*. 1997;314(7080):553-8.
49. **Steptoe A, and Kivimaki M.** Stress and cardiovascular disease: an update on current knowledge. *Annu Rev Public Health*. 2013;34(337-54).
50. **Levine HJ.** Rest heart rate and life expectancy. *J Am Coll Cardiol*. 1997;30(4):1104-6.
51. **Brosschot JF, Gerin W, and Thayer JF.** The perseverative cognition hypothesis: a review of worry, prolonged stress-related physiological activation, and health. *J Psychosom Res*. 2006;60(2):113-24.
52. **Thomsen DK, Mehlsen MY, Hokland M, Viidik A, Olesen F, Avlund K, Munk K, and Zachariae R.** Negative thoughts and health: associations among rumination, immunity, and health care utilization in a young and elderly sample. *Psychosom Med*. 2004;66(3):363-71.



# CHAPTER 9

## General discussion





## GENERAL DISCUSSION

The overall hypothesis of the Switchbox study is that maintenance of homeostasis is pivotal for maintenance of health in old age. Therefore, the aim of this thesis as part of the Switchbox study, was to expand our knowledge of homeostatic mechanisms at old age, thus trying to unravel underlying mechanisms of healthy human longevity. The primary endocrine systems of investigation of this thesis were the hypothalamic-pituitary-thyroid (HPT) and the hypothalamic-pituitary-adrenal (HPA) axes.

Previous research, done on thyroid function in relation with human longevity in the Leiden Longevity Study (LLS) found that families with the lowest family mortality history score, had the highest levels of thyroid stimulating hormone (TSH) and the lowest levels of free thyroxine (fT4) and free triiodothyronine (fT3)(1). Moreover in the Leiden 85-plus study, survival advantages were associated with higher TSH levels in 85 and 90 years old participants(2, 3). Also in other cohorts high TSH was associated with longevity(4). Taken together, this may imply that lower thyroid status is a heritable phenotype that contributes to exceptional longevity. However, underlying mechanisms and the effects of changes in HPT-axis function on familial longevity remained elusive.

The HPA-axis is the most important neuro-endocrine stress response system of our body and is of critical importance for survival. Changes in HPA-axis function are associated with different diseases including diabetes, hypertension, high blood pressure and insulin resistance(5-9); however no data is available on the changes in HPA-axis function and human longevity.

### Hypothalamic-pituitary-thyroid axis function in longevity

Although we and others have previously found multiple indications for changes in the HPT-axis in human longevity, the precise mechanisms behind these findings and their physiological effects were not yet established(3). In chapter 4 we found that familial longevity was characterized by higher thyroid stimulating hormone (TSH) secretion, in the absence of differences in thyroid hormone (TH) levels and energy metabolism. In this study we explored a number of different candidate mechanisms that might underlie the increased TSH secretion (Figure 1A). One potential mechanism was reduced bioactivity of TSH (Figure 1B) in the offspring; however in both offspring and partners TSH was equally bioactive. Moreover, we considered diminished sensitivity of the thyrotrophs to negative feedback by thyroid hormones less likely, because if thyrotrophs would be less sensitive, the levels of fT4 would also increase(10). Furthermore, the regularity of TSH secretion (assessed by approximate entropy (ApEn) of TSH) was comparable between groups, which is indicative of intact thyroid hormone mediated feedback on TRH and TSH secretion (Figure 1C)(11). Another explanation of the increased TSH secretion was enhanced thyroid hormone turnover in peripheral tissues (Figure 1D). This is likely not the case in our study

population, since the T3/reverse T3 (rT3) ratio, which is correlated with deiodinase 1 activity in the liver(12), was not different between the groups. In **chapter 5** we further investigated the underlying mechanisms for the increased total TSH secretion by studying ultradian and circadian rhythmicity of TSH. There were no differences between offspring and partners in the pulsatile secretion of TSH or in the TSH circadian rhythmicity, both measures which have previously been associated with ageing and disease(11, 13, 14). We found that the increase in total TSH secretion was fully attributable to increased basal (non-pulsatile) TSH secretion (Figure 1A). Besides Thyrotropin releasing hormone (TRH), TSH is also under the influence of somatostatin (SST), glucocorticoids and dopamine. We considered changes in SST and glucocorticoids as causes of enhanced TSH secretion unlikely, since there were no differences in leptin levels and body weight or in ACTH and cortisol levels between the groups (**chapter 7**). Taken together, three remaining possible underlying mechanisms for the increased TSH secretion might be 1) diminished responsiveness of the thyroid gland to TSH, thus overall more TSH would be needed to ensure the same amount of thyroid hormone output (Figure 1 E) diminished central dopaminergic tone or 3) a combination of both. It is a hypothetical possibility that offspring from their birth onwards have a lower dopaminergic tone, leading to decreased suppression of TSH (more TSH) secretion and that the decreased thyroidal sensitivity to TSH is a compensatory mechanisms to maintain fT4 and fT3 within the normal range to maintain energy homeostasis. To test these hypotheses, future experiments should focus on challenge experiments with a low dose of thyrogen (recombinant TSH), which significantly increases TSH and TH levels in healthy volunteers(15) or bromocriptine(16), a dopamine agonist, which lowers TSH secretion, in offspring of long-lived siblings and their partners. Many ageing theories have linked energy metabolism to the ageing process, including the 'rate of living theory' which states that the positive correlation between lifespan and size implicates that species differences in resting metabolic rate and the 'free radical theory of ageing' which proposed that byproducts of oxidative metabolism may underlie the negative correlation between life span and resting metabolic rate. In **chapter 4 and 5** we did not find differences in circulatory thyroid hormone levels (fT3, fT4 and T3) between the groups of offspring and partners included in the Switchbox study. In line in **chapter 4** we did not find differences between groups in resting metabolic rate or in core body temperature, implying that differences in energy metabolism are not likely an underlying mechanisms for healthy familial longevity. However besides metabolism, the HPT-axis plays also a key role in developmental processes. In adult mammalian tissues, damaged and worn-out mature cells are continuously being replaced during normal tissue homeostasis and in response to stress or damage. The decline in regenerative capacity of tissues is a characteristic of ageing as is stated in the stem cell theory of ageing(17). This process is dependent on differentiation of



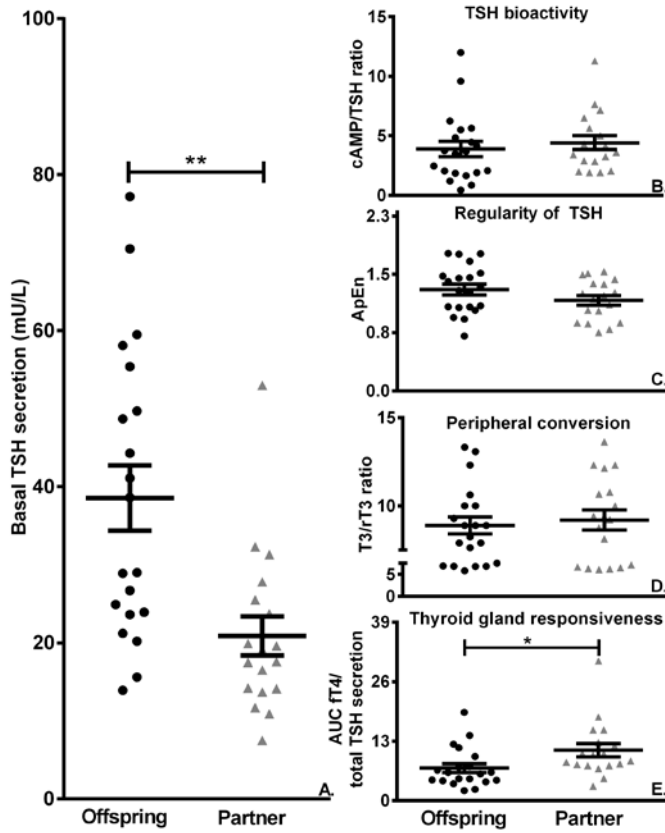

**Figure 1** Exploration of mechanisms underlying increased levels of TSH secretion in offspring from long-lived siblings and partners.

Black circles represent 20 offspring, grey triangles represent 18 partners. Solid lines represent mean with standard error of the mean (SEM) of **A.** basal TSH secretion **B.** cAMP/TSH ratio **C.** ApEn **D.** T3/rT3 ratio **E.** AUC ft4/total TSH secretion. AUC= area under the curve. \*  $P < 0.05$  \*\*  $P \leq 0.01$ .

self-renewing, tissue-specific stem cells. Recently, it was found that the TSH-receptor was expressed on bone marrow-derived mesenchymal stem cells in humans(18). Moreover, TSH was found to induce gene expression of mediators involved in self-renewal, maintenance, development and differentiation(18). If TSH may play a role in self-renewal, maintenance, development and differentiation of (mesenchymal) stem cells, we hypothesize that high TSH might prevent precocious depletion of tissue specific stem cells by slowing tissue turnover rates. For example, during bone

remodeling, bone is renewed by a balanced process of resorption of old bone and new bone formation preventing damage accumulation and maintaining bone strength and mineral homeostasis. To investigate our hypothesis we measured bone turnover markers (e.g.  $\beta$ -crosslaps, P1NP and Alkaline Phosphatase) and found indications that osteoclastogenesis may be suppressed by high circulatory TSH levels. Besides on bone cells and mesenchymal stem cells, the TSH-receptor is also expressed in brown adipose tissue (BAT), skeletal muscles and the brain. Therefore we suggest that pleiotropic effects of the HPT-axis may protect long-lived families by extra-thyroidal effects of TSH on target tissues and cells that are important for maintenance of health up to old age.

### Hypothalamic-pituitary-adrenal axis function in longevity

Many different adverse conditions have been associated with changes in HPA-axis function, however no data is available on HPA-axis function in relation with longevity. Therefore, in **chapter 6**, in 330 offspring and partners from the LLS, cortisol was measured from saliva samples collected in a home based setting in the morning, to assess the awakening response, and in the evening. Moreover, to test HPA-axis feedback sensitivity an 0.5 mg overnight dexamethasone test was performed. We observed that offspring from long-lived siblings had a slightly lower cortisol awakening response and lower cortisol levels in the evening. However, no differences were found in the HPA-axis feedback sensitivity. This may indicate that offspring from long-lived siblings had a slightly lower HPA-axis function. To further explore the HPA-axis function in relation with familial longevity, we measured in 38 offspring and partners from the LLS, 24-hour levels of both cortisol and ACTH. Since cortisol alone does not reflect HPA-axis activity. In **chapter 7**, we used state of the art mathematical models to study secretion profiles of ACTH and cortisol in a relative small subgroup under resting conditions in a laboratory setting. We found no significant differences between offspring and partners in 24-hour mean plasma concentrations of ACTH and serum cortisol concentrations, although we did find some modest, sex-specific differences, including non-significantly higher mean plasma ACTH levels in female offspring and significantly higher basal ACTH secretion in male offspring. Likewise, offspring and partners did not exhibit major differences in secretory regularity of ACTH and cortisol or feedforward and feedback synchrony and the endogenous ACTH-cortisol dose-response relationship. These results were seemingly conflicting with the differences observed in saliva cortisol in a much larger study sample (**chapter 6**). One of the explanations may be the strict inclusion and exclusion-criteria for the 24-hour blood sampling study that may have resulted in the inclusion of very healthy offspring and partners. Another explanation may be the difference in study setting; the study described in **chapter 6** was in a home-based setting while the study in **chapter 7** was performed under laboratory conditions. A third possible

explanation is the difference in sampling methods. In **chapter 6** we investigated saliva cortisol levels, which correlate most with free cortisol levels, while in **chapter 7**, serum cortisol levels were measured which predominantly reflect total cortisol. Under resting conditions, 70% of the cortisol is bound to Corticosteroid Binding Globulin (CBG), 20% is bound to albumin and only 10% of the cortisol is unbound and in its free form(19). Possibly, the proportion between bound and unbound cortisol is different between offspring and partners. Moreover, the sample size in the 24-hour ACTH and cortisol measurements study was small compared to that of the saliva cortisol sample study. As a consequence, it may thus only have been possible to detect relatively large differences between groups, such as the 60% higher TSH secretion in the offspring group (**chapter 4** and **chapter 5**).

Overall we may conclude that familial longevity is not associated with major differences in the HPA-axis activity under resting conditions, although modest, sex-specific differences may exist between the groups that are clinically relevant. Since the differences in resting conditions were small, in **chapter 8** we challenged the HPA-axis using the Trier Social Stress Test (TSST), to induce acute social stress. The TSST is a well validated laboratory stress test also up to higher ages(20). We found that male offspring enriched for familial longevity compared to male non-offspring may have a slightly lower overall physiological response to a psychological stressor. Moreover, we found that offspring were more relaxed than non-offspring in the run-up to participating in the experiment, although during the stress experiment both scored comparable for their subjective stress. Cortisol acts through 2 types of receptors which both have a different function during the stress reaction. The mineralocorticoid receptor (MR) is involved in the appraisal process and the onset of the stress response, the glucocorticoid receptor (GR) is only activated by large amounts of corticosteroids and is involved in termination of the stress reaction(21). Different SNP's of the MR are associated with positive appraisal of a stressor(22). Moreover, during ageing the MR expression is lower resulting in increased ACTH secretion. As mentioned above we found in **chapter 7** in female offspring a non-significant tendency towards higher mean plasma ACTH concentrations compared to female controls and in male offspring higher basal ACTH secretion compared to male controls. In line, the Brown Norway rat, who are long-living, is characterized by unchanged serum corticosterone levels with amplified ACTH secretion and a faster recovery after restraint stress(23, 24). Based on the findings of the TSST another explanation for the differences in findings under resting conditions emerges. In the home based settings, participants had to do the experiment themselves, and partners might have worried more in anticipation of the experiment while the offspring were more relaxed and therefore had lower cortisol levels. In the study under laboratory conditions, both offspring and partners were already in the hospital the day before and were both adapted to their new situation.

Thus, offspring enriched for longevity tended to have slightly lower salivary cortisol levels in a home based setting. This may be a reflection of their more healthy phenotype. In addition offspring may tend to worry less prior to and have a lower peak when confronted with an actual stressor. During one's life one is repetitively exposed to social stressors, such as (negative) social interactions with -or evaluations from- family or (voluntary) work. So offspring from long-lived families may tend to worry less prior to events, which together with a lower starting point in physiological responses, and a lower peak when confronted with an actual stressor, might limit damage due to stress over a lifetime.

### Future perspectives

This thesis explored homeostatic mechanisms, in particular the hypothalamic-pituitary –thyroid- and –adrenal axis, and gave insight in healthy human longevity. First we found that offspring from long-lived siblings had a 60% higher TSH secretion, without changes in thyroid hormones (fT4 and fT3). In line, there were no differences between offspring and partners in available measures of energy metabolism (basal metabolic rate and core body temperature). Second, offspring tended to have lower saliva (free) cortisol in the morning and evening compared to partners. However, no major differences comparable to those observed for TSH, were detected in the regulation of ACTH and cortisol over 24 hours under resting conditions. However, offspring tended to have a smaller overall cortisol output in response to stress and tended to worry less prior to a stressful event. These results indicate that subtle differences in the HPA-axis between groups may exist and underpin the important role of challenge experiments in amplifying such subtle differences.

Future studies should aim to disentangle underlying mechanisms of the increased TSH secretion and lower overall cortisol output during a stress experiment in offspring. One underlying mechanism that might explain both the increased TSH levels and lower overall cortisol response to stress in offspring compared to their partners is a lower dopamine release. Future experiments may therefore focus on dopamine release in relation with familial longevity. One way in humans is to measure prolactin secretion, which is mainly regulated by dopamine. Moreover, future studies should focus on performing challenge experiments using recombinant TSH (Thyrogen) to test the resistance of the thyroid gland for TSH, which also might be an underlying mechanism of the increased TSH. Moreover the extra-thyroidal effects of TSH should be studied in more detail, since this may result in therapeutic options. For example, recently it was found that intermittent injections with recombinant TSH can prevent and restore bone loss, at least in mice(25). Moreover we should explore the underlying mechanisms, that explain why offspring tend to worry less prior to stress full events and have a smaller overall cortisol output during a stress experiment as these are also of clinical relevance in our 24.7 society.

## REFERENCES

1. **Rozing MP, Houwing-Duistermaat JJ, Slagboom PE, Beekman M, Frolich M, de Craen AJ, Westendorp RG, and van Heemst D.** Familial longevity is associated with decreased thyroid function. *J Clin Endocrinol Metab.* 2010;95(11):4979-84.
2. **Gussekkloo J, van Exel E, de Craen AJ, Meinders AE, Frolich M, and Westendorp RG.** Thyroid status, disability and cognitive function, and survival in old age. *JAMA.* 2004;292(21):2591-9.
3. **Bowers J, Terrien J, Clerget-Froidevaux MS, Gothie JD, Rozing MP, Westendorp RG, van Heemst D, and Demeneix BA.** Thyroid hormone signaling and homeostasis during aging. *Endocr Rev.* 2013;34(4):556-89.
4. **Atzmon G, Barzilai N, Surks MI, and Gabriely I.** Genetic predisposition to elevated serum thyrotropin is associated with exceptional longevity. *J Clin Endocrinol Metab.* 2009;94(12):4768-75.
5. **McEwen BS.** Protective and damaging effects of stress mediators. *N Engl J Med.* 1998;338(3):171-9.
6. **Phillips DI, Barker DJ, Fall CH, Seckl JR, Whorwood CB, Wood PJ, and Walker BR.** Elevated plasma cortisol concentrations: a link between low birth weight and the insulin resistance syndrome? *J Clin Endocrinol Metab.* 1998;83(3):757-60.
7. **Walker BR, Phillips DI, Noon JP, Panarelli M, Andrew R, Edwards HV, Holton DW, Seckl JR, Webb DJ, and Watt GC.** Increased glucocorticoid activity in men with cardiovascular risk factors. *Hypertension.* 1998;31(4):891-5.
8. **Walker BR, Soderberg S, Lindahl B, and Olsson T.** Independent effects of obesity and cortisol in predicting cardiovascular risk factors in men and women. *J Intern Med.* 2000;247(2):198-204.
9. **Wirtz PH, von Kanel R, Emimi L, Ruedisueli K, Groessbauer S, Maercker A, and Ehler U.** Evidence for altered hypothalamus-pituitary-adrenal axis functioning in systemic hypertension: blunted cortisol response to awakening and lower negative feedback sensitivity. *Psychoneuroendocrinology.* 2007;32(5):430-6.
10. **Yagi H, Pohlenz J, Hayashi Y, Sakurai A, and Refetoff S.** Resistance to thyroid hormone caused by two mutant thyroid hormone receptors beta, R243Q and R243W, with marked impairment of function that cannot be explained by altered in vitro 3,5,3'-triiodothyronine binding affinity. *J Clin Endocrinol Metab.* 1997;82(5):1608-14.
11. **Roelfsema F, and Veldhuis JD.** Thyrotropin secretion patterns in health and disease. *Endocr Rev.* 2013;34(5):619-57.
12. **Peeters RP, Wouters PJ, van Toor H, Kaptein E, Visser TJ, and Van den Berghe G.** Serum 3,3',5'-triiodothyronine (rT3) and 3,5,3'-triiodothyronine/rT3 are prognostic markers in critically ill patients and are associated with postmortem tissue deiodinase activities. *J Clin Endocrinol Metab.* 2005;90(8):4559-65.
13. **Chen JM, Huang CQ, Ai M, and Kuang L.** Circadian rhythm of TSH levels in subjects with Alzheimer's disease (AD). *Aging Clin Exp Res.* 2013;25(2):153-7.
14. **Bartalena L, Placidi GF, Martino E, Falcone M, Pellegrini L, Dell'Osso L, Pacchiarotti A, and Pinchera A.** Nocturnal serum thyrotropin (TSH) surge and the TSH response to TSH-releasing hormone: dissociated behavior in untreated depressives. *J Clin Endocrinol Metab.* 1990;71(3):650-5.
15. **Nielsen VE, Bonnema SJ, and Hegedus L.** Effects of 0.9 mg recombinant human thyrotropin on thyroid size and function in normal subjects: a randomized, double-blind, cross-over trial. *J Clin Endocrinol Metab.* 2004;89(5):2242-7.
16. **Kok P, Roelfsema F, Frolich M, van Pelt J, Meinders AE, and Pijl H.** Bromocriptine reduces augmented thyrotropin secretion in obese premenopausal women. *J Clin Endocrinol Metab.* 2009;94(4):1176-81.
17. **Lopez-Otin C, Blasco MA, Partridge L, Serrano M, and Kroemer G.** The hallmarks of aging. *Cell.* 2013;153(6):1194-217.
18. **Bagriacik EU, Yaman M, Haznedar R, Sucak G, and Delibasi T.** TSH-induced gene expression involves regulation of self-renewal and differentiation-related genes in human bone marrow-derived mesenchymal stem cells. *J Endocrinol.* 2012;212(2):169-78.
19. **Brien TG.** Human corticosteroid binding globulin. *Clin Endocrinol (Oxf).* 1981;14(2):193-212.

20. **Kudielka BM, Buske-Kirschbaum A, Hellhammer DH, and Kirschbaum C.** HPA axis responses to laboratory psychosocial stress in healthy elderly adults, younger adults, and children: impact of age and gender. *Psychoneuroendocrinology*. 2004;29(1):83-98.
21. **de Kloet ER, Joels M, and Holsboer F.** Stress and the brain: from adaptation to disease. *Nat Rev Neurosci*. 2005;6(6):463-75.
22. **Klok MD, Giltay EJ, Van der Does AJ, Geleijnse JM, Antypa N, Penninx BW, de Geus EJ, Willemsen G, Boomsma DI, van Leeuwen N, Zitman FG, de Kloet ER, and DeRijk RH.** A common and functional mineralocorticoid receptor haplotype enhances optimism and protects against depression in females. *Transl Psychiatry*. 2011;1(e62).
23. **Marissal-Arvy N, Lombes M, Petterson J, Moisan MP, and Mormede P.** Gain of function mutation in the mineralocorticoid receptor of the Brown Norway rat. *J Biol Chem*. 2004;279(38):39232-9.
24. **van Eekelen JA, Rots NY, Sutanto W, and de Kloet ER.** The effect of aging on stress responsiveness and central corticosteroid receptors in the brown Norway rat. *Neurobiol Aging*. 1992;13(1):159-70.
25. **Sun L, Vukicevic S, Baliram R, Yang G, Sendak R, McPherson J, Zhu LL, Iqbal J, Latif R, Natrajan A, Arabi A, Yamoah K, Moonga BS, Gabet Y, Davies TF, Bab I, Abe E, Sampath K, and Zaidi M.** Intermittent recombinant TSH injections prevent ovariectomy-induced bone loss. *Proc Natl Acad Sci U S A*. 2008;105(11):4289-94.







## Nederlandse samenvatting



## INTRODUCTIE

Door de vooruitgang in de medische wetenschap is er een afname van kindersterfte en een afname van sterfte op middelbare leeftijd ten gevolge van hart- en vaatziekten. Hierdoor zijn er wereldwijd grote demografische veranderingen die worden gekenmerkt door een toename in de levensverwachting alsmede in het aandeel van ouderen(1). Hierdoor is het van belang om genetische, omgevings-gerelateerde en biologische mechanismen te bestuderen die ervoor kunnen zorgen dat mensen gezond en actief blijven tot in de tachtig, negentig of zelfs daarboven(2). Wij kunnen van deze gezonde ouderen leren hoe de levensverwachting in goede gezondheid verlengd kan worden.

### Leiden Langleven studie

Een voorbeeld van een studie die de genetische, omgevings-gerelateerde en biologische mechanismen bestudeert is de Leiden Langleven studie (LLS)(2). Deze studie onderzoekt waardoor mensen gezond kunnen blijven tot op hoge leeftijd. In de LLS zijn tussen 2002 en 2006 421 Nederlandse families geïncludeerd. Van deze families moesten tenminste twee broers en/of zussen van een generatie in leven zijn, die minimaal 89 jaar oud in geval van mannen en 91 jaar in geval van vrouwen waren. De gezondheidsstatus maakte hierbij niet uit. Eerdere studies hebben aangetoond dat nakomelingen van deze negentig of honderdjarigen zelf ook een grotere kans hebben om langlevend te worden, hetgeen pleit voor een familiale component van menselijke langlevendheid(3). Om factoren die mogelijk gerelateerd zijn aan langlevendheid te vinden, werd aan de nakomelingen van deze langlevende broers en zussen gevraagd om ook aan de studie deel te nemen, tezamen met hun partners, die dienden als controlegroep. Deze nakomelingen en hun partners delen vaak al voor langere tijd hun leven en hebben daarom een vergelijkbare leefstijl, socio-economische status en achtergrond.

### Switchbox studie

Het werk beschreven in dit proefschrift is uitgevoerd in het kader van het Europese project Switchbox, dat gecoördineerd wordt door Professor Barbara Demeneix van het 'Centre National de la Recherche Scientifique Paris, France'. In Switchbox hebben zes partners van vijf verschillende Europese landen de gezamenlijke hypothese getoetst dat gezondheid tot op hoge leeftijd behouden kan worden door een betere homeostase. Al in 1865 definieerde de Franse fysioloog Claude Bernard homeostase als de mogelijkheid van het lichaam om zich dynamisch aan te passen aan invloeden van buitenaf, zodat de condities in het lichaam binnen bepaalde grenzen blijven. Er zijn twee belangrijke systemen die zorgen voor het behoud van homeostase: ten eerste het centrale zenuwstelsel dat informatie doorgeeft door middel van elektrische signalen via neuronen en ten tweede hormonen die informatie doorgeven via chemische

signalen en receptoren. Dit proefschrift richt zich met name op de hypothalamus-hypofysaire-schildklier-as (schildklier-as) en de hypothalamus-hypofysaire-bijnier-as (bijnier-as).

### **Hormonen en langlevendheid**

De schildklier-as speelt een belangrijke rol gedurende het hele leven en stuurt belangrijke processen in het lichaam aan zoals weefselontwikkeling en -vernieuwing, energiemetabolisme. Daarbij is bekend dat in modelorganismen de schildklierhormoonwaarden de snelheid van verouderen beïnvloeden(4). Er is een negatief verband gevonden tussen het schildklierhormoon thyroxine (T4) en de maximale leeftijd van kleine zoogdieren waaronder de cavia, naakte molrat en Damara molrat(5). In verschillende muizensoorten werd er een associaties gevonden tussen een laag T4 op jonge leeftijd en een stabiel T4 gedurende het leven en het hebben van een langer leven(4). Maar ook bij mensen zijn er associaties gevonden tussen schildklierhormonen en langlevendheid. Zo is er bijvoorbeeld binnen de LLS gevonden dat negentigjarigen uit de families met de laagste sterfte over het algemeen de hoogste waardes van het schildklierstimulerend hormoon hadden en de laagste waardes van de schildklierhormonen(6). In een andere studie bij honderdjarige Askenazische Joden en hun nakomelingen is gevonden dat zij ook hogere schildklierstimulerende hormoonwaardes hadden in vergelijking met een controlegroep(7).

De bijnier-as is van belang voor overleving en speelt een belangrijke rol bij allostase (stabiliteit door verandering). Hierdoor is het lichaam in staat om op fysiologische maar ook psychologische stressoren te reageren. Dagelijks staan wij bloot aan chronische en acute (vecht- of vluchtreactie) stress, waardoor er schade aan de stress-reactieve fysiologische systemen van ons lichaam kan ontstaan. Voorbeelden van deze systemen zijn het hart-en vaatstelsel en de glucose regulerende systemen. Schade hieraan kan op langere termijn negatieve gevolgen hebben voor onze gezondheid. Veranderingen in de bijnier-as worden geassocieerd met hoge bloeddruk, cognitieve stoornissen en andere negatieve metabole veranderingen. In een speciale soort rat (Brown Norway rat)(8) is gevonden dat een sneller herstel van de bijnier-as na een stressor is geassocieerd met een langer leven, terwijl een ander type rat (Wistar Kyoto rat), die sterker reageert op een stressor, een kortere levensduur heeft(9).

### **Hoofdbevindingen**

In dit proefschrift is er gekeken naar de schildklier-as en de bijnier-as in familiäre langlevendheid door aspecten van deze assen te vergelijken tussen nakomelingen van langlevende families en een controlegroep. De 'functie' van de schildklier- en bijnier-as is onderzocht door het meten van een aantal hormonen. Daarnaast zijn de fysiologische processen (zoals hartslag en stofwisseling) die door deze hormonen gereguleerd worden, onder verschillende omstandigheden onderzocht.

Het doel van dit proefschrift was drieledig. In het eerste deel is de studieopzet van de Switchbox Leiden studie omschreven tezamen met de dataverzameling en de 24-uursbloedafnamemethode. In het tweede deel is de hypothalamus-hypofysaire-schildklier-as en in het derde deel is de hypothalamus-hypofysaire-bijnier-as in relatie met familiale langlevendheid onderzocht.

## **De hypothalamus-hypofysaire-schildklier-as en familiale langlevendheid**

Hoewel er in eerdere onderzoeken aanwijzingen zijn gevonden voor veranderingen in de schildklier-as in relatie met familiale langlevendheid, waren de onderliggende mechanismen en de fysiologische effecten hiervan onbekend. In hoofdstuk 4 is gevonden dat familiale langlevendheid gekenmerkt wordt door een hogere secretie van het schildklierstimulerende hormoon (TSH). Echter, schildklierhormoonwaarden en de stofwisseling in rust waren niet verschillend. Er zijn vier mechanismen onderzocht die mogelijk kunnen bijdragen aan een verhoogde TSH secretie (figuur 1). Een van de onderliggende mechanismen is een verminderde bioactiviteit van TSH in de nakomelingen van langlevende families. Er is geen verschil in TSH bioactiviteit tussen beide groepen gevonden (figuur 1A). Een ander mogelijk mechanisme is een verminderde gevoeligheid van de thyrotrofe cellen in de hypofyse voor de negatieve regulatie van de schildklierhormonen. Deze hypothese is minder aannemelijk, omdat dan de schildklierhormoonwaarden juist hoger zouden moeten zijn. Daarbij was de regulariteit van de TSH secretie vergelijkbaar in beide groepen (figuur 1B). Dit betekent dat er een intacte schildklierhormoongemedieerde feedback is op de TRH en TSH secretie(10). Een andere mogelijke verklaring voor de verhoogde TSH secretie is een toegenomen schildklierhormoonverbruik in de perifere weefsels. Echter, deze hypothese was ook niet aannemelijk omdat de T3/reverseT3(rT3)-ratio, welke gecorreleerd is aan deiodinase 1 activiteit in de lever(11), vergelijkbaar was in beide groepen (figuur 1C). De meest waarschijnlijke oorzaak voor de verhoogde TSH-secretie is een verminderde gevoeligheid van de schildklier voor TSH. Figuur 1D geeft de verhouding weer tussen de totale secretie van fT4 over 24 uur en TSH. Deze is significant lager bij nakomelingen van langlevende families in vergelijking met hun partners. Dit wil zeggen dat er meer TSH nodig is voor dezelfde hoeveelheid fT4 over 24 uur. In hoofdstuk 5 werd de toegenomen TSH-secretie in meer detail bestudeerd. In dit hoofdstuk hebben we de secretie bestudeerd. Dit omvat korte terugkerende cycli (ultradiane secretie) en de secretie over 24 uur (circadiaanse ritme). Er werden geen verschillen gevonden tussen de nakomelingen van langlevende families en hun partners in het ultradiane of het circadiaanse ritme. Wel werd er gevonden dat de verhoogde totale TSH-secretie over 24 uur werd veroorzaakt door de basale (niet-pulsatieve) TSH-secretie. De secretie van TSH staat onder invloed van verschillende hormonen waarvan thyrotropin-releasing hormoon (TRH) het meest bekend is.

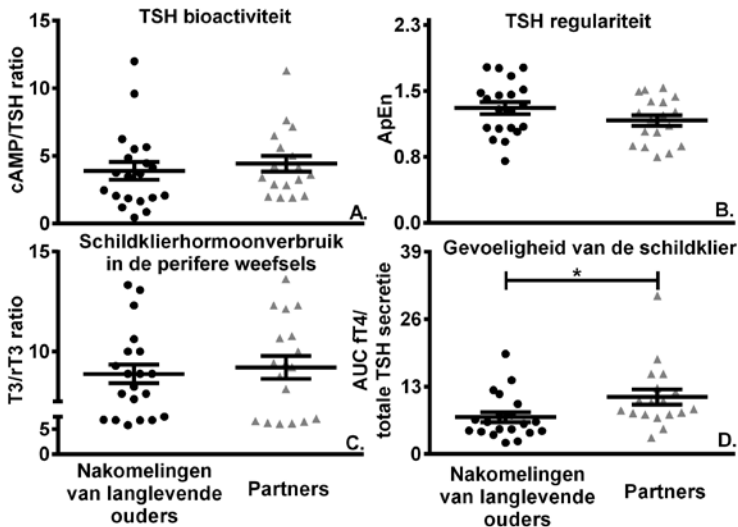

**Figure 1** Vier mechanismen die mogelijk kunnen bijdragen aan een verhoogde TSH-secretie.

De zwarte bolletjes vertegenwoordigen 20 nakomelingen van langlevende families en de grijze driehoekjes zijn 18 partners. De zwarte lijn is het gemiddelde met de standaard fout van het gemiddelde van **A.** de TSH bioactiviteit, **B.** de TSH regulariteit, **C.** het schildklierhormoonverbruik in de perifere weefsels, **D.** de gevoeligheid van de schildklier.

TSH-secretie staat echter ook onder invloed van somatostatine, glucocorticoïden en dopamine, maar veranderingen in somatostatine en glucocorticoïden als onderliggend mechanisme voor verhoogde TSH-secretie zijn onwaarschijnlijk. Dit omdat er geen verschillen zijn gevonden in leptinewaarden, lichaamsgewicht, ACTH en cortisolwaarden tussen nakomelingen van langlevende families en hun partners (hoofdstuk 7).

Samenvattend resteren er drie mogelijke onderliggende mechanismen die kunnen zorgen voor een verhoogde TSH-secretie. Ten eerste zou een verminderde gevoeligheid van de schildklier voor TSH een verklaring kunnen zijn. Hierdoor is er meer TSH nodig om dezelfde hoeveelheid schildklierhormoon te krijgen. Ten tweede zou er centraal minder dopamine kunnen zijn. Ten slotte zou er sprake kunnen zijn van een combinatie van beide. Een van de hypothesen is dat de nakomelingen vanaf hun geboorte centraal minder dopamine hebben, waardoor TSH minder onderdrukt wordt en de TSH secretie hoger is. De verminderde gevoeligheid van de schildklier voor TSH zou hierop een reactie kunnen zijn om de schildklierhormoonwaarden binnen hun grenzen te houden en zo een normaal energie metabolisme te waarborgen

waardoor homeostase behouden blijft. Deze hypothese zullen we in de toekomst moeten testen om meer zekerheid te verkrijgen.

Er zijn verschillende verouderingstheorieën die het energie metabolisme aan het verouderingsproces relateren. Een voorbeeld daarvan is de 'rate of living theory' waarin een positieve correlatie wordt beschreven tussen de levensverwachting en de snelheid van de stofwisseling in rust bij verschillende diersoorten. Een ander voorbeeld, de 'free radical theory of ageing', stelt dat bijproducten van het zuurstof-metabolisme mogelijk ten grondslag liggen aan de negatieve correlatie tussen levensverwachting en de snelheid van de stofwisseling in rust. In hoofdstuk 4 en 5 werden geen verschillen in circulerende waardes van de schildklierhormonen (fT3, fT4, T3) gevonden tussen de nakomelingen van langlevende families en hun partners. In hoofdstuk 4 werden ook geen verschillen gevonden tussen deze groepen in energiemetabolisme in rust of in de centrale lichaamstemperatuur. Dit betekent dat verschillen in het energiemetabolisme hoogstwaarschijnlijk geen onderliggend mechanisme zijn voor gezond ouder worden. Echter, de schildklier-as is naast het energiemetabolisme ook betrokken bij groei en ontwikkeling. Gedurende het leven vervangt het lichaam beschadigde en oude volgroeide cellen voortdurend tijdens de normale weefselhomeostase en in reactie op stress of ten gevolge van schade. In de 'stem cell theory of ageing' wordt de afname van deze regenererende capaciteit van het weefsel als eigenschap van veroudering gezien. Dit proces is afhankelijk van de differentiatie van zichzelf hernieuwende weefsel-specifieke stamcellen. Recent is ontdekt dat er bij mensen sprake was van TSH-receptorexpressie op mesenchymale stamcellen. Daarbij is gevonden dat TSH kan zorgen voor gen-expressie van mediators die betrokken zijn bij differentiatie, ontwikkeling, behoud en zichzelf hernieuwende capaciteit van stamcellen. Als TSH een rol speelt in deze processen van (mesenchymale) stamcellen, kan een hypothese zijn dat een hoog TSH voorkomt dat er een tekort is aan weefsel-specifieke stamcellen en daarmee de weefselvernieuwing kan vertragen. Behalve mesenchymale stamcellen, wordt de TSH-receptor ook tot expressie gebracht op botcellen, bruin vetweefsel, skeletspieren en de hersenen. Wij denken dat pleiotrope effecten van de schildklier-as deze langlevende families beschermen door effecten van TSH op andere weefsels dan de schildklier en dat dit een belangrijke rol speelt in het behoud van gezondheid tot op hoge leeftijd.

### **De hypofysaire-bijnieras en familiale langlevendheid**

In hoofdstuk 6 wordt een studie beschreven waarbij speekselcortisolmonsters zijn afgenomen bij 330 nakomelingen van langlevende families en hun partners. Deze monsters zijn in de ochtend door de deelnemers zelf in hun eigen thuissituatie afgenomen met behulp van een wattenstaafje. Met behulp van deze methode is de cortisol concentratie in de ochtend en in de avond gemeten. Verder is ook de terugkoppeling van de bijnier-as onderzocht door deelnemers voor het slapen gaan

0.5 mg dexamethason te laten innemen gevolgd door een nieuwe meting de volgende morgen. Er is gevonden dat de nakomelingen in vergelijking met hun partners in de ochtend in nuchtere conditie een lagere plasma cortisol concentratie hadden en lagere cortisolwaarden in de avond, maar we vonden geen verschillen in de gevoeligheid van de bijnier-as. Om dit in meer detail te bestuderen hebben we in hoofdstuk 7 gedurende 24 uur bij 38 deelnemers elke 10 minuten zowel cortisol als ACTH gemeten. Dit omdat alleen cortisol geen goede weerspiegeling is van de HPA-as functie. Met behulp van deconvolutie analyse zijn deze 24-uurs profielen in meer detail bestudeerd. Er werden geen significante verschillen gevonden tussen nakomelingen van langlevende families en hun partners in 24-uursconcentratie van ACTH en cortisol, al waren er wel enkele geslachtsafhankelijke verschillen. Verder waren er geen grote verschillen in de terugkoppeling en aansturing van ACTH en cortisol en de endogene ACTH-cortisol dosis-response curves. De resultaten gevonden in hoofdstuk 6 en hoofdstuk 7 lijken elkaar tegen te spreken. Een mogelijke verklaring voor de verschillen tussen de studies kan gezocht worden in verschillen in de in- en exclusiecriteria. Mogelijk hebben de strenge in- en exclusiecriteria die gebruikt zijn voor de 24-uursbloedafnamestudie geresulteerd in inclusie van zeer gezonde nakomelingen en partners. Een andere mogelijkheid is het verschil in studiesetting. In de studie beschreven in hoofdstuk 6 waren de deelnemers thuis, terwijl de deelnemers in de studie van hoofdstuk 7 in het LUMC verbleven. Een andere mogelijkheid is het verschil in materiaal en meetmethode. In hoofdstuk 6 werd cortisol in speeksel gemeten. Dit komt het meest overeen met vrij cortisol. In hoofdstuk 7 is echter serum cortisol gemeten wat meer overeenkomt met het totale cortisol. In rust is 70% van het cortisol gebonden aan corticosteroid bindend globuline (CB) en 20% is gebonden aan albumine en slechts 10% van het cortisol bevindt zich in vrije toestand(12). Het is mogelijk dat de verhouding tussen gebonden en vrij cortisol verschillend is tussen de groepen. Daarbij komt nog dat de groepsgrootte van de 24-uursstudie veel kleiner was dan die van de speekselcortisolstudie. Als gevolg hiervan is het dus mogelijk dat wij alleen grote verschillen konden vinden in de 24-uursstudie, zoals de 60% hogere TSH-secretie die we vonden in de nakomelingen-groep in hoofdstuk 4 en hoofdstuk 5.

Het is onwaarschijnlijk dat familiale langlevendheid wordt gekenmerkt door grote veranderingen in de bijnier-as activiteit in rust, al zijn er wel kleine geslachtsafhankelijke verschillen gevonden tussen de groepen. Omdat de verschillen in rust zo klein waren zijn de deelnemers in de studie beschreven in hoofdstuk 8 onderworpen aan de 'Trier Social Stress Test (TSST) om acute sociale stress te onderzoeken. De TSST is een gevalideerde stresstest om de stressreactie te onderzoeken van jong tot oud(13). In vergelijking met mannelijke controles hadden de mannelijke nakomelingen van langlevende families mogelijk een iets lagere fysiologische response op een psychologische stressor. Daarnaast waren de nakomelingen meer ontspannen in



aanloop naar het onderzoek toe. Echter, gedurende het stressonderzoek scoorden beide groepen gelijk ten aanzien van de subjectieve stresswaarneming. Cortisol heeft effect op 2 type receptoren welke beiden een andere functie hebben tijdens stress. De mineralocorticoid receptor (MR) is belangrijk voor de taxatie van een nieuwe situatie en belangrijk voor het begin van de stressreactie. De glucocorticoid receptor (GR) is alleen geactiveerd bij grote hoeveelheden corticosteroiden en is van belang bij het beëindigen van de stressreactie(14). Veranderingen in de MR kunnen leiden tot een positieve benadering van een stressor(15). Daarbij is bekend dat met verouderen de expressie van de MR receptor lager is wat zorgt voor meer secretie van ACTH. Wij vonden in hoofdstuk 7, dat vrouwelijke nakomelingen van langlevende families een niet significante trend hadden voor een hogere gemiddelde ACTH concentratie in vergelijking met vrouwelijke controles. In mannelijke nakomelingen van langlevende families vonden we een significant hogere basale ACTH secretie in vergelijking met mannelijke controles. Deze bevindingen zijn vergelijkbaar met de 'Brown Norway Rat', welke ook langlevend is. Deze rat wordt gekenmerkt door onveranderde corticosteron waarden met een versterkte ACTH secretie en een sneller herstel na stress(16, 17). Op basis van TSST bevindingen was er nog een verklaring voor de verschillen in hoofdstuk 6 en 7. In hoofdstuk 6, waar de deelnemers in de thuisituatie hun speekselmonsters zelf moesten afnemen is het mogelijk dat de partners zich meer zorgen maakten over de procedure dan de nakomelingen. In de studie in hoofdstuk 7 waren ze al in het ziekenhuis en waren ze gewend aan de nieuwe situatie.

We kunnen concluderen dat nakomelingen van langlevende families een iets lagere speekselcortisolwaarde hebben in de thuisituatie. Daarbij maken deze nakomelingen zich waarschijnlijk minder zorgen voorafgaand aan een stresssituatie en reageren ze met een lagere cortisolpiek wanneer ze daadwerkelijk met stress geconfronteerd worden. Mensen worden gedurende hun gehele leven herhaaldelijk bloot gesteld aan sociale stressoren (werk, privé, studie). Hierbij maken nakomelingen van langlevende families zich mogelijk minder zorgen voorafgaand aan dergelijke gebeurtenissen, waardoor ze een lager startpunt hebben van de fysiologische response op stress. Daarnaast hebben ze ook een lagere piek wanneer zij daadwerkelijk met stress geconfronteerd worden. Tezamen zorgt dit mogelijk voor minder schade door stress gedurende het leven.

### **Toekomstperspectieven**

In dit proefschrift is gekeken naar homeostatische mechanismen en in het bijzonder de hypothalame-hypofysaire-schilddklier en de bijnier-as. Er zijn verschillende inzichten verworven over gezond ouder worden. Allereerst is er gevonden dat nakomelingen van langlevende families een 60% hogere TSH-secretie hadden zonder veranderingen in de schildklierhormonen. Daarbij waren er geen verschillen in het energiemetabo-

lisme (stofwisseling in rust en centrale lichaamstemperatuur). Ten tweede hadden de nakomelingen een iets lager vrij speekselcortisol in de ochtend en avond. Echter, in rust zijn geen grote verschillen waargenomen in de regulatie van ACTH en cortisol over 24 uur. Echter, na stress hadden de nakomelingen van langlevende families een iets lagere cortisoloutput en maakten ze zich minder zorgen voorafgaand aan een stressvolle situatie. Deze resultaten laten zien dat er subtiele verschillen aanwezig zijn in de HPA-as tussen de groepen en ze onderschrijven het belang van de rol van experimenten die het lichaam 'uitdagen' om zo subtiele verschillen te vergroten.

Vervolgstudies moeten erop gericht zijn de mechanismen die mogelijk ten grondslag liggen aan de verhoogde TSH-secretie en lagere cortisoloutput gedurende stressexperimenten verder te ontrafelen. Een onderliggend mechanisme dat beide bevindingen mogelijk kan verklaren is een lager dopamine bij de nakomelingen. Toekomstige experimenten kunnen gericht zijn op het bestuderen van de dopamine release in relatie met familiale langlevendheid. Door prolactine te meten kan iets gezegd worden over de hoeveelheid dopamine, omdat prolactine hoofdzakelijk door dopamine wordt gereguleerd. Ook zullen toekomstige studies zich moeten richten op het stimuleren van de schildklier met recombinant TSH (thyrogen). Hiermee wordt de gevoeligheid van de schildklier voor TSH getest en kan de hypothese getoetst worden dat een verminderde gevoeligheid voor TSH ten grondslag ligt aan de verhoogde TSH-secretie. Daarnaast is het belangrijk om mogelijke extra-thyroidale effecten van TSH te bestuderen omdat dit kan resulteren in therapeutische opties. Verder zou het interessant zijn om te bestuderen welke mechanismen ten grondslag liggen aan de vragen waarom de nakomelingen van langlevende families zich minder druk maken voorafgaand aan een stressvolle situatie en waardoor ze een lagere cortisoloutput hebben gedurende een stressexperiment. Deze vragen zijn van belang voor onze hectische 24-uursmaatschappij.

## REFERENTIES

1. **Abbott A.** Ageing: growing old gracefully. *Nature*. 2004;428(6979):116-8.
2. **Schoenmaker M, de Craen AJ, de Meijer PH, Beekman M, Blauw GJ, Slagboom PE, and Westendorp RG.** Evidence of genetic enrichment for exceptional survival using a family approach: the Leiden Longevity Study. *Eur J Hum Genet*. 2006;14(1):79-84.
3. **Westendorp RG, van Heemst D, Rozing MP, Frolich M, Mooijaart SP, Blauw GJ, Beekman M, Heijmans BT, de Craen AJ, Slagboom PE, and Leiden Longevity Study G.** Nonagenarian siblings and their offspring display lower risk of mortality and morbidity than sporadic nonagenarians: The Leiden Longevity Study. *J Am Geriatr Soc*. 2009;57(9):1634-7.
4. **Bowers J, Terrien J, Clerget-Froidevaux MS, Gothie JD, Rozing MP, Westendorp RG, van Heemst D, and Demeneix BA.** Thyroid hormone signaling and homeostasis during aging. *Endocr Rev*. 2013;34(4):556-89.
5. **Buffenstein R, and Pinto M.** Endocrine function in naturally long-living small mammals. *Mol Cell Endocrinol*. 2009;299(1):101-11.
6. **Rozing MP, Houwing-Duistermaat JJ, Slagboom PE, Beekman M, Frolich M, de Craen AJ, Westendorp RG, and van Heemst D.** Familial longevity is associated with decreased thyroid function. *J Clin Endocrinol Metab*. 2010;95(11):4979-84.
7. **Atzmon G, Barzilai N, Surks MI, and Gabriely I.** Genetic predisposition to elevated serum thyrotropin is associated with exceptional longevity. *J Clin Endocrinol Metab*. 2009;94(12):4768-75.
8. **Mos J, and Hollander CF.** Analysis of survival data on aging rat cohorts: pitfalls and some practical considerations. *Mech Ageing Dev*. 1987;38(1):89-105.
9. **Tizabi Y, Aguilera G, and Gilad GM.** Age-related reduction in pituitary corticotropin-releasing hormone receptors in two rat strains. *Neurobiol Aging*. 1992;13(2):227-30.
10. **Roelfsema F, and Veldhuis JD.** Thyrotropin secretion patterns in health and disease. *Endocr Rev*. 2013;34(5):619-57.
11. **Peeters RP, Wouters PJ, van Toor H, Kaptein E, Visser TJ, and Van den Berghe G.** Serum 3,3',5'-triiodothyronine (rT3) and 3,5,3'-triiodothyronine/rT3 are prognostic markers in critically ill patients and are associated with postmortem tissue deiodinase activities. *J Clin Endocrinol Metab*. 2005;90(8):4559-65.
12. **Brien TG.** Human corticosteroid binding globulin. *Clin Endocrinol (Oxf)*. 1981;14(2):193-212.
13. **Kudielka BM, Buske-Kirschbaum A, Hellhammer DH, and Kirschbaum C.** HPA axis responses to laboratory psychosocial stress in healthy elderly adults, younger adults, and children: impact of age and gender. *Psychoneuroendocrinology*. 2004;29(1):83-98.
14. **de Kloet ER, Joels M, and Holsboer F.** Stress and the brain: from adaptation to disease. *Nat Rev Neurosci*. 2005;6(6):463-75.
15. **Klok MD, Giltay EJ, Van der Does AJ, Geleijnse JM, Antypa N, Penninx BW, de Geus EJ, Willemsen G, Boomsma DI, van Leeuwen N, Zitman FG, de Kloet ER, and DeRijk RH.** A common and functional mineralocorticoid receptor haplotype enhances optimism and protects against depression in females. *Transl Psychiatry*. 2011;1(e62).
16. **Marissal-Arvy N, Lombes M, Petterson J, Moisan MP, and Mormede P.** Gain of function mutation in the mineralocorticoid receptor of the Brown Norway rat. *J Biol Chem*. 2004;279(38):39232-9.
17. **van Eekelen JA, Rots NY, Sutanto W, and de Kloet ER.** The effect of aging on stress responsiveness and central corticosteroid receptors in the brown Norway rat. *Neurobiol Aging*. 1992;13(1):159-70.



## List of publications



**Jansen SW**, van Heemst D, van der Grond J, Westendorp R, Oei NY. Physiological responding to stress in middle-aged males enriched for longevity: a social stress study. *Stress*. 2015 Nov 9:1-9.

Akintola AA, Noordam R, **Jansen SW**, de Craen AJ, Ballieux BE, Cobbaert CM, Mooijaart SP, Pijl H, Westendorp RG, van Heemst D. Accuracy of Continuous Glucose Monitoring Measurements in Normo-Glycemic Individuals. *PLoS One*. 2015 Oct 7;10(10):e0139973.

**Jansen SW**, Roelfsema F, van der Spoel E, Akintola AA, Postmus I, Ballieux BE, Slagboom PE, Cobbaert CM, van der Grond J, Westendorp RG, Pijl H, van Heemst D. Familial Longevity Is Associated With Higher TSH Secretion and Strong TSH-ft3 Relationship. *J Clin Endocrinol Metab*. 2015 Oct;100(10):3806-13.

Akintola AA, **Jansen SW**, van Bodegom D, van der Grond J, Westendorp RG, de Craen AJ, van Heemst D. Subclinical hypothyroidism and cognitive function in people over 60 years: a systematic review and meta-analysis. *Front Aging Neurosci*. 2015 Aug 11;7:150.

Akintola AA, van den Berg A, Altmann-Schneider I, **Jansen SW**, van Buchem MA, Slagboom PE, Westendorp RG, van Heemst D, van der Grond J. Parameters of glucose metabolism and the aging brain: a magnetization transfer imaging study of brain macro- and micro-structure in older adults without diabetes. *Age (Dordr)*. 2015 Aug;37(4):9802. doi: 10.1007/s11357-015-9802-0

**Jansen SW**, Roelfsema F, Akintola AA, Oei NY, Cobbaert CM, Ballieux BE, van der Grond J, Westendorp RG, Pijl H, van Heemst D. Characterization of the Hypothalamic-Pituitary-Adrenal-Axis in Familial Longevity under Resting Conditions. *PLoS One*. 2015 Jul 20;10(7).

**Jansen SW\***, Akintola AA\*, Roelfsema F, van der Spoel E, Cobbaert CM, Ballieux BE, Egri P, Kvarta-Papp Z, Gereben B, Fekete C, Slagboom PE, van der Grond J, Demeneix BA, Pijl H, Westendorp RG, van Heemst D. Human longevity is characterised by high thyroid stimulating hormone secretion without altered energy metabolism. *Sci Rep*. 2015 Jun 19;5:11525.

Akintola AA, van den Berg A, van Buchem MA, **Jansen SW**, Slagboom EP, Westendorp RG, van der Grond J, van Heemst D. Associations between insulin action and integrity of brain microstructure differ with familial longevity and with age. *Front Aging Neurosci*. 2015 May 28;7:92.

Akintola AA\*, **Jansen SW\***, Wilde RB, Hultzer G, Rodenburg R, van Heemst D. A simple and versatile method for frequent 24 h blood sample collection in healthy older adults. *MethodsX*. 2014 Dec 26;2:33-8.

Noordam R, **Jansen SW\***, Akintola AA\*, Oei NY, Maier AB, Pijl H, Slagboom PE, Westendorp RG, van der Grond J, de Craen AJ, van Heemst D; Leiden Longevity Study group. Familial longevity is marked by lower diurnal salivary cortisol levels: the Leiden Longevity Study. *PLoS One*. 2012;7(2).

Sabayan B, **Jansen S**, Oleksik AM, van Osch MJ, van Buchem MA, van Vliet P, de Craen AJ, Westendorp RG. Cerebrovascular hemodynamics in Alzheimer's disease and vascular dementia: a meta-analysis of transcranial Doppler studies. *Ageing Res Rev*. 2012 Apr;11(2):271-7.

\* equal contribution of both authors.







# Curriculum Vitae



(Steffy) Wilhelmina Maria Jansen was born on the 20<sup>th</sup> of June 1986 in 's-Hertogenbosch, the Netherlands. In 2004 she graduated from high school at gymnasium Beekvliet in Sint-Michielsgestel. She studied medicine from 2004-2010 at Maastricht University. After her graduation in 2010, she followed the 1-year master Vitality and Ageing at the Leyden Academy. In 2011 she was offered a position as a PhD student at the Department of Gerontology and Geriatrics at the Leiden University Medical Center. She became involved in the European funded Switchbox study. She participated in the study design, recruitment, measurements, database management and analyses of data obtained from participants. From June 2015 she started to work as a resident (anios) in Geriatrics at the Catharina Hospital in Eindhoven. In December 2015 she started her specialist training in Geriatrics at the Catharina Hospital in Eindhoven under the supervision of Dr. C. van der Linden.



Dankwoord





Dit dankwoord betekent dat de verdediging van mijn proefschrift en daarmee de afsluiting van een bijzondere periode in mijn leven dichtbij is. De afgelopen vier jaren hebben veelvuldig in het teken van mijn promotietraject gestaan met als resultaat mijn naam pronkend op de voorkant van dit proefschrift. Ondanks dat mijn naam op dit werk staat is dit niet het resultaat van één persoon. Dit proefschrift is tot stand gekomen met hulp van velen. Allereerst wil ik alle deelnemers van de Leiden Langleven studie hartelijk bedanken voor hun inzet en enthousiasme voor de wetenschap en natuurlijk voor het leuke contact tijdens de studiedagen. Het heeft mijn promotietijd zeker verrijkt!

Graag wil ik mijn dank uitspreken aan mijn co-promotor Dr. Ir. D. van Heemst en promotoren prof. dr. H. Pijl en prof. dr. R. Westendorp. Beste Diana, jouw gedrevenheid, toewijding en hulpvaardigheid hebben mij doen groeien als persoon. Ook dank voor al je vertrouwen en positiviteit tijdens het opzetten en uitvoeren van de studie. Beste Hanno, mede door jouw kennis en inzet zijn de studies met 24-uurs bloedafnames geslaagd. Dank voor alle leerzame discussies en betrokkenheid bij het schrijven van de manuscripten. Beste Rudi, jouw enthousiasme heeft me doen kiezen voor de master Vitality and Ageing, een keuze waar ik nooit spijt van heb gehad. Dank voor alle discussies. Ik vond de wijze waarop je de data beschouwde erg inspirerend.

Een bijzondere plaats verdient Dr. F. Roelfsema. Beste Ferdinand, jij hebt jouw omvangrijke kennis over endocrinologie met mij gedeeld en me in de wereld van deconvolutie-analyse geïntroduceerd. Dank voor al je wijze woorden en fijne gesprekken.

Uiteraard wil ik ook mijn collega's bedanken. Zij zorgden ervoor dat ik met nog meer plezier naar mijn werk ging. Ik kon altijd bij hen terecht voor vragen of een gezellig praatje. Dank, Iris, Bart, Stella, Liselotte, Behnam, Marriëtte, Anne Suzanne, Marjon, Roelof, Floor, Evie en Raymond. Abi wil ik in het bijzonder bedanken. Met Abi heb ik alle experimenten uitgevoerd en ruim 4 jaar zeer intensief samen gewerkt. Ondanks dat we twee verschillende persoonlijkheden zijn, en soms letterlijk dag en nacht samen waren, hebben we het maar mooi gedaan. Ik heb veel van je geleerd! Graag wil ik ook Dr. N. Oei bedanken. Beste Nicole, vele uren hebben we samen gescand. Tevens hebben we onze deelnemers, en soms ook onszelf, in stressvolle situaties gebracht. De samenwerking in Amsterdam resulteerde in een prachtig artikel. Je hebt me ontzettend veel geleerd, zowel op wetenschappelijk als persoonlijk gebied, dank hiervoor! Daarnaast wil ik Christine, Marjan, Ellen, Charlotte en Meriam bedanken voor jullie hulp bij het versturen van brieven, het bellen van deelnemers en de administratie hiervan. Jolanda, Bart en de andere medewerkers van het CKCL, bedankt voor jullie tijd en geduld bij het inregelen van alle bepalingen van dit lastige project. Ook Bep dank ik voor jouw hulp tijdens de studiedagen en Rob voor jouw expertise bij het inbrengen van infusen en lijnen tijdens de 24-uurs bloedafnames.

En natuurlijk alle studenten die bij het Switchboxonderzoek stage hebben gelopen; dank voor jullie inzet.

Zonder ontspanning geen inspanning. Daarom bedank ik op deze plaats mijn vrienden. Ik noem er graag een aantal in het bijzonder: Ten eerste de geweldige vriendengroep uit Gestel: Bram, Brams, Carolien, Marieke, Marlot, Nan, Neeltje, Nina, Pieter, Roel en Twan. Daarnaast de lieve en allerleukste 'Calypso' vriendinnen uit Maastricht: Ed, Eef, Gwen, Mies en Myrt. Tenslotte bedank ik het gezellige en sportieve hockeyteam Groen-Geel dames 8!

Tevens wil ik graag mijn familie bedanken, die altijd interesse toonde voor wat ik deed en waar ik altijd bij terecht kon, dank voor alles!

Graag wil ik ook mijn lieve paranimfen Edith en Roel bedanken. Lieve Ed, mijn mede-Haags-hopje. Dank voor je steun en begrip als mede-promovendi maar bovenal dank voor al je gezelligheid en mooie vriendschap. Ook Roel wil ik bedanken. Zonder jou had ik hier nooit gestaan. Bedankt voor het geduld tijdens de wiskunde(bij)lessen en voor jouw steun na het verlies van mijn moeder.

Een bijzonder plekje voor mijn ouders. Zonder de hulp en steun van mijn vader en moeder had ik dit nooit bereikt. Mijn lieve moeder heeft me in 16 jaar zoveel liefde gegeven. Ze leerde me een van de meest belangrijke dingen voor dit promotieonderzoek: doorzetten en niet opgeven. En mijn lieve vader die altijd achter me staat, me steunt en altijd een luisterend oor heeft. Hij heeft de laatste 13 jaar een dubbelrol gehad, die hij met verve vervuld heeft. Zijn harde werkersmentaliteit en 'niet zeuren' zijn een goed voorbeeld geweest om dit proefschrift succesvol af te ronden.

En als allerlaatste bedank ik Michiel. Jij weet intussen ook wel wat van de schildklier en het stresshormoon af en jouw geduld is dan ook vaak op de proef gesteld totdat dit proefschrift af was. Ik vind het heel fijn om elke dag bij jou thuis te komen, dank voor je interesse, steun en liefde!



