



Universiteit  
Leiden  
The Netherlands

## Total synthesis of alginate and zwitterionic SP1 oligosaccharides

Zhang, Q.

### Citation

Zhang, Q. (2018, September 6). *Total synthesis of alginate and zwitterionic SP1 oligosaccharides*. Retrieved from <https://hdl.handle.net/1887/65053>

Version: Not Applicable (or Unknown)

License: [Licence agreement concerning inclusion of doctoral thesis in the Institutional Repository of the University of Leiden](#)

Downloaded from: <https://hdl.handle.net/1887/65053>

**Note:** To cite this publication please use the final published version (if applicable).

Cover Page



Universiteit Leiden



The handle <http://hdl.handle.net/1887/65053> holds various files of this Leiden University dissertation.

**Author:** Zhang, Q.

**Title:** Total synthesis of alginate and zwitterionic SP1 oligosaccharides

**Issue Date:** 2018-09-06

# **Total Synthesis of Alginate and Zwitterionic SP1 Oligosaccharides**

PROEFSCHRIFT

ter verkrijging van

de graad van Doctor aan de Universiteit Leiden

op gezag van Rector Magnificus prof. mr. C. J. J. M. Stolker,

volgens het besluit van het College voor Promoties

te verdedigen op donderdag 6 september 2018

klokke 13:45 uur

door

**Qingju Zhang**

张庆举

Geboren te Biyang, Henan, China in 1982

## Promotiecommissie

Promotor: Prof. dr. G. A. van der Marel

Co-promotor: Dr. J. D. C. Codée

Overig leden:

Prof. dr. B. Yu (Shanghai Institute of Organic Chemistry, CAS)

Prof. dr. G. -J. Boons (Utrecht University)

Dr. M. T. C. Walvoort (University of Groningen)

Prof. dr. H. S. Overkleeft

Prof. dr. J. Brouwer

Doctoral Thesis, Leiden University, 2018

Cover design: Qingju Zhang and Li Kong

Printed by GVO drukkers&vormgevers B.V.

**Where there is a will, there is a way!**

**有志者事竟成**

## **Table of contents**

<b>List of abbreviations</b>	<b>6</b>
<b>General Introduction</b>	<b>9</b>
<b>Chapter 1</b>	<b>17</b>
Synthetic Alginate oligosaccharides	
<b>Chapter 2</b>	<b>33</b>
Synthetic Zwitterionic polysaccharides	
<b>Chapter 3</b>	<b>47</b>
On the Reactivity of Gulose and Guluronic Acid Building Blocks in the Context of Alginate Assembly	
<b>Chapter 4</b>	<b>87</b>
Acceptor Reactivity in the Total Synthesis of $\alpha$ -L-guluronic acid and $\beta$ -D-mannuronic acid containing Alginate fragments	

<b>Chapter 5</b>	<b>119</b>
Chemical Synthesis of Guanosine Diphosphate Mannuronic Acid (GDP-ManA) and its C-4- <i>O</i> -methyl and C-4-deoxy Congeners	
<b>Chapter 6</b>	<b>137</b>
Selective Oxidation of primary alcohol to carboxylic acid by use of two-step one-pot TEMPO/BAIB-Pinnick oxidation	
<b>Chapter 7</b>	<b>155</b>
Total Synthesis of Zwitterionic SP1 Oligosaccharides	
<b>Chapter 8</b>	<b>215</b>
Summary and Future prospects	
<b>Curriculum Vitae</b>	<b>225</b>
<b>List of Publications</b>	<b>226</b>

## List of abbreviations

Ac	acetyl	eq	molar equivalents
ACN	acetonitrile	ESI	electrospray ionization
All	allyl	Et	ethyl
AIBN	2,2'-azobis(2-methyl-propionitrile)	GDP	Guanosine diphosphate
Arom	aromatic	Gla	glactose
aq.	aqueous	Gul	gulose
BAIB	[bis(acetoxy)iodo]benzene	h	hour
Bn	benzyl	HRMS	high resolution mass spectrometry
BOM	Benzyloxyl methyl	Hz	Hertz
bs	broad	HSQC	Heteronuclear single quantum coherence
BSP	1-benzenesulfinyl piperidine	IR	infrared spectroscopy
Bu	butyl	isoprop	isopropylidene
Bz	benzoyl	IC <sub>50</sub>	Inhibitor concentration resulting in half-maximal enzyme activity
cat.	catalytic	<i>J</i>	coupling constant
CEM	cyanoethylmethyl	LCMS	liquid chromatography mass spectrometry
ClAc	chloroacetyl	Lev	levulinoyl
Cq	quarternary carbon atom	m	multiplet
Cbz	benzyloxycarbonyl	MALDI	Matrix-associated laser Desorption/ionization
COSY	Correlation spectroscopy	Man	D-mannose
d	doublet	MannA	D-mannuronic acid
DBU	1,8-diazabicyclo[5.4.0]undec-7-ene	Me	methyl
DCM	dichloromethane	min	minute
DCE	1,2-dichloroethane	NAc	<i>N</i> -acetyl
dd	doublet of doublets	NBS	<i>N</i> -bromosuccinimide
DIBAL-H	di- <i>iso</i> -butylaluminium hydride	NCS	<i>N</i> -chlorosuccinimide
DiPEA	<i>N,N</i> -di- <i>iso</i> -propyl- <i>N</i> -ethylamine	NIS	<i>N</i> -iodosuccinimide
DMAP	4-dimethylaminopyridine		
DMF	<i>N,N</i> -dimethylformamide		
DMSO	dimethylsulfoxide		
DTBMP	2,6-di- <i>tert</i> -butyl-4-methylpyridine		



PE	petroleum ether
Ph	phenyl
Phth	phthaloyl
Piv	pivaloyl
ppm	parts per million
Pr	propyl
py	pyridine
rt	room temperature
s	singlet
Sat.	saturated
t	triplet
TBAB	tetra- <i>n</i> -butylammonium bromide
TBAI	tetra- <i>n</i> -butylammonium iodide
<i>t</i> Bu	<i>tert</i> -butyl
TBDPS	<i>tert</i> -butyldiphenylsilyl
TBS	<i>tert</i> -butyldimethylsilyl
Tf	trifluoromethanesulfonyl
TFA	trifluoroacetic acid
THF	tetrahydrofuran
TEMPO	2,2,6,6-tetramethyl-1-piperidinyloxy
TLC	thin layer chromatography
TLR	Toll like receptor
Tol	<i>para</i> -toluyl
TMS	trimethylsilyl
Ts	tosyl / <i>para</i> -toluenesulfonyl
TTBP	2,4,6-tri- <i>tert</i> -butylpyrimidine
UV	ultraviolet



# General Introduction

## Introduction

Carbohydrates are one of the major classes of biopolymers, alongside nucleic acids and proteins, and they fulfill a plethora of biological functions.<sup>[1]</sup> Carbohydrates not only serve as intermediates in cellular energy production but also as important structural components (cellulose is the most abundant biomolecule on earth) and as signaling molecules. They also play an important role in normal cell functions as well as in major pathologies, including cancer, cardiovascular disease and inflammatory diseases.<sup>[2]</sup> To investigate their biological functions,<sup>[3]</sup> enable medical applications such as the development of carbohydrate-based vaccines,<sup>[4]</sup> generate functional materials,<sup>[5]</sup> sufficient amounts of structurally well-defined and pure oligo- and polysaccharides and glycoconjugates are needed. Often it is difficult to get enough pure carbohydrates from natural resources and therefore synthesis, either through organic chemical or enzymatic means, has become one of the main suppliers delivering these molecules.

Synthetic carbohydrate chemistry has made considerable progress over the last half century. Effective protecting group strategies have been developed to address the multitude of different hydroxyls functions in the carbohydrate building blocks.<sup>[6]</sup> Many powerful glycosylation methods have been developed,<sup>[7]</sup> employing various donor glycosides, such as anomeric halides (in the classical Koenigs-Knorr method for example),<sup>[7e]</sup> thioglycosides,<sup>[7m]</sup> trichloroacetimidates<sup>[7c]</sup> and the closely related N-phenyl trifluoroacetimidates<sup>[7l]</sup> and O-alkynylbenzoates.<sup>[7o]</sup> To streamline oligosaccharide assembly, various effective strategies have been developed, including reactivity-based,<sup>[8]</sup>

## General Introduction

---

orthogonal activation<sup>[9]</sup> or pre-activation<sup>[10]</sup> enabled one-pot syntheses. Automated solid phase oligosaccharide synthesis is growing into a mature synthesis technique,<sup>[11]</sup> with a commercial instrument now available. Long (up to a 50-mer) and complex oligosaccharides have already been assembled using a fully automated set-up. Over the years many enzymes have become available for the regio- and stereoselective construction of glycosidic linkages and many of the mammalian glycosides can now in principle be generated using enzymatic or chemoenzymatic synthesis.<sup>[12]</sup> Especially for the construction of sialic acid containing oligosaccharides enzymatic synthesis has become the method of choice.

Despite all the progress made, the stereoselective introduction of 1,2-*cis*-glycosidic bonds still remains a major challenge in many oligosaccharide synthesis campaigns. Scheme 1 summarizes some of the methods that are currently available for the stereoselective construction of glycosidic linkages. In an intramolecular aglycon delivery (IAD) strategy (Scheme 1A), as developed by Stork,<sup>[13]</sup> Bols,<sup>[14]</sup> and Ogawa and Ito<sup>[15]</sup> for example, the donor and acceptor are tethered together and this way the activated donor glycoside can only be attacked from one face of the ring. Recently, hydrogen bond-mediated aglycon delivery (HAD) was introduced by Demchenko to direct the acceptor to the desired face of the donor glycoside.<sup>[16]</sup> Boons and co-workers developed C2-chiral auxiliaries, to selectively shield one face of the donor glycoside as depicted in Scheme 1C.<sup>[17]</sup> Takahashi and Toshima<sup>[18]</sup> reported on the use of borinic esters to glycosylate minimally protected carbohydrates in an S<sub>N</sub>i-type reaction with glycosyl epoxides.<sup>[19]</sup> Several conformationally restricted donor systems have been introduced over the years to allow the stereoselective construction of glycosidic linkages (See Scheme 1E). A major

breakthrough was accomplished by Crich and co-workers,<sup>[20]</sup> who introduced 4,6-benzylidene mannosyl donors for the stereoselective formation of  $\beta$ -mannosides. Silylidene protected galactosides reliably provide 1,2-*cis*-galactosides in glycosylation reactions by effective steric shielding of the  $\beta$ -face of the donor.<sup>[21]</sup> Lactone donors have been used by the groups of van der Marel and Codée,<sup>[22]</sup> Ito,<sup>[23]</sup> and Boltje.<sup>[24]</sup> Cyclic 2*N*,3*O*-carbamates, introduced by Kerns and co-workers, have successfully been employed for the stereoselective introduction of  $\alpha$ -glucosamine linkages.<sup>[25]</sup> Later this principle was translated to cyclic carbonates and applied for the construction of  $\alpha$ -sialic acids.<sup>[26]</sup> Also, furanosyl donors have been equipped with cyclic protecting groups to control the conformation of the glycosylating species in order to attain stereoselective glycosylation reactions.<sup>[27]</sup> 3,5-silylidene protected arabinofuranoses can be used for the construction of 1,2-*cis*-arabinosides.<sup>[28]</sup> Much recent effort is directed at the *in situ* generation of reactive species that allow for stereoselective glycosylation reactions through the use of nucleophilic additives, or reactivity modulators. Notable achievements include the use of DMF in the construction of 1,2-*cis*-glucosides as initiated by Mong and co-workers.<sup>[29]</sup> An important asset of the use of nucleophilic additives is the fact that they can tune the reactivity of the glycosylating species to match the reactivity of the acceptor at hand as shown by Wang *et al.*<sup>[30]</sup>

## General Introduction

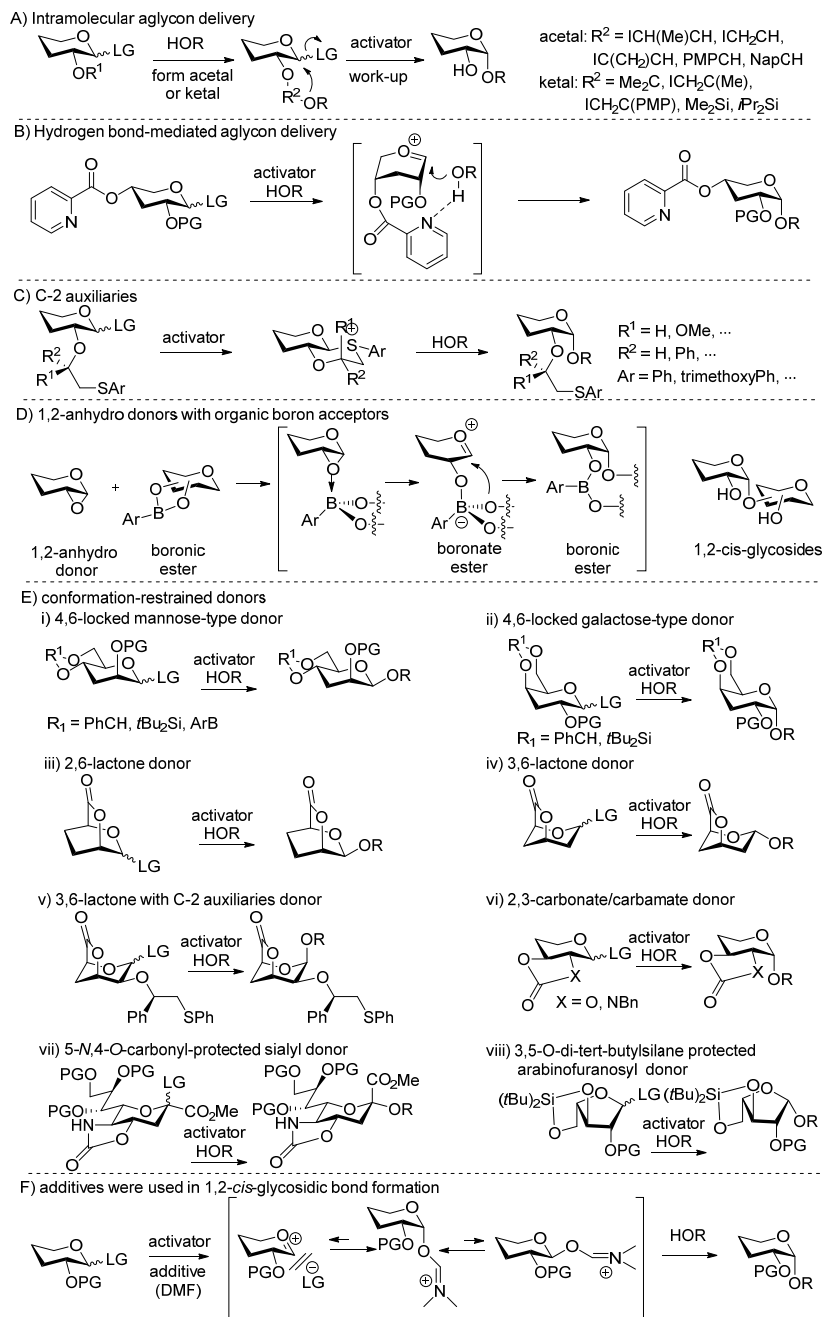

**Scheme 1.** Examples of 1,2-*cis*-stereoselective glycosylation. A) intramolecular aglycon delivery; B) hydrogen bond-mediated aglycon delivery; C) C-2 auxiliaries; D) 1,2-anhydro donors with stannylated acceptors; E) conformation-restrained donors; F) using additives.

The methods depicted in Scheme 1 show that many clever solutions have been conceived for the stereoselective synthesis of 1,2-cis-glycosidic linkages. The diversity of the methods however, also makes it clear that there is not a unified solution to the problem and the assembly of complex oligosaccharides, featuring rare (deoxy) building blocks, labile functional groups or complex substitution patterns requires the development of ever more sophisticated synthesis strategies. This thesis addresses the synthesis of two classes of complex polysaccharides: the alginates and zwitterionic polysaccharides.

### **Aim and outline of this thesis**

This Thesis reports the synthesis of fragments of alginates and zwitterionic *Streptococcus pneumoniae* SP1 polysaccharides. Alginate is an important constituent of the biofilm produced by *Pseudomonas aeruginosa* and Chapter 1 provides a concise overview of the synthesis of alginate oligosaccharides, featuring  $\beta$ -d-mannuronic acid or  $\alpha$ -l-guluronic acid linkages. Chapter 2 describes all syntheses of zwitterionic polysaccharides fragments, reported to date. Chapter 3 and Chapter 4 describe the synthesis of alginate fragments containing both  $\beta$ -d-mannuronic and  $\alpha$ -l-guluronic acids. Chapter 5 shows the synthesis of guanosine diphosphate mannuronic acid (GDP-ManA) and its C-4-O-methyl and C-4-deoxy congeners to be used for alginate biosynthesis studies. Chapter 6 introduces a new oxidation protocol for the selective oxidation of primary alcohols to carboxylic acids by use of a two-step one-pot TEMPO/BAIB-Pinnick oxidation sequence, which can be used for the generation of complex uronic acid containing oligosaccharides. Chapter 7 describes the total synthesis and structural analysis of long zwitterionic SP 1 oligosaccharides. Chapter 8 finally summarizes the results obtained in this Thesis and outlines some future prospects.

### References

- [1] *Carbohydrate Chemistry, Biology and Medical Applications: 1st Edition*, H. Garg, M. Cowman and C. Hales (eds), Elsevier Science, **2008**.
- [2] A. Varki, *Glycobiology* **1993**, *3*, 97-130.
- [3] C. R. Bertozzi and L. Kiessling, *Science*, **2001**, *291*, 2357-2364.
- [4] a) J. Hütter and B. Lepenies, *Methods Mol Biol*, 2015,1331,1-10. b) J. I. Zhu, J. David Warren and S. J. Danishefsky, *Expert Rev Vaccines*, **2009**, *8*, 1399-1413. c) *Carbohydrate-based Drug Discovery*. Volume 1. C. H. Wong (Ed.) **2003** Wiley-VCH, Weinheim. Chapter 15 pp 407-433. d) A. A. Klyosov, *Glycobiology and drug design*, ACS Symposium Series; American Chemical Society: Washington, DC, **2012**.
- [5] A. S. Carlini, L. Adamiak, and N. C. Gianneschi, *Macromolecules*, **2016**, *49*, 4379-4394.
- [6] K. Ágoston, H. Streicher, P. Fügedi, *Tetrahedron: Asymmetry*, **2016**, *27*, 707-728.
- [7] Some reviews on glycosylation methods. a) G. Wulff and G. Röhle, *Angew. Chem. Int. Ed. Engl*, **1974**, *13*, 157-170. b) H. Paulsen, *Angew. Chem. Int. Ed. Engl*, **1982**, *21*, 155-173. c) R. R. Schmidt, *Angew. Chem. Int. Ed. Engl*, **1986**, *25*, 212-235. d) H. Kunz, *Angew. Chem. Int. Ed. Engl*, **1987**, *26*, 294-308. e) K. Toshima and K. Tatsuta, *Chem. Rev*, **1993**, *93*, 1503-1531. f) G. J. Boons, *Tetrahedron*, **1996**, *52*, 1095-1121. g) S. J. Danishefsky and M. T. Bilodeau, *Angew. Chem. Int. Ed. Engl*, **1996**, *35*, 1380-1419. h) B. G. Davis, *J. Chem. Soc, Perkin Trans. 1*, **2000**, 2137-2160. i) K. C. Nicolaou and H. Mitchell, *Angew. Chem. Int. Ed*, **2001**, *40*, 1576-1624. j) A. V. Demchenko, *Synlett*, **2003**, 1225-1240; k) X. Zhu and R. R. Schmidt, *Angew. Chem., Int. Ed.*, **2009**, *48*, 1900-1934. l) B. Yu and J. S. Sun, *Chem. Commun*, **2010**, *46*, 4668-4679. m) G. Lian, X. Zhang, B. Yu, *Carbohydr. Res*, **2015**, *403*, 13-22. n) P. Peng, R. R. Schmidt, *Acc. Chem. Res*. **2017**, *50*, 1171-1183. o) B. Yu, *Acc. Chem. Res*. **2018**, *51*, 507-516.
- [8] a) J. D. C. Codée, R. E. J. N. Litjens, L. J. van den Bos, H. S. Overkleeft and G. A. van der Marel, *Chem. Soc. Rev*, **2005**, *34*, 769-782. b) L. Huang, Z. Wang and X. Huang, *Chem. Commun*, **2004**, 1960-1961.
- [9] a) B. Yu, Z. Yang and H. Cao, *Current Organic Chemistry*, **2005**, *9*, 179-194. b) Y. Hu, K. Yu, L. Shi, L. Liu, J. Sui, D. Liu, B. Xiong and S. Sun, *J. Am. Chem. Soc*. **2017**, *139*, 12736-12744.
- [10] a) X. Huang, L. Huang, H. Wang and X. Ye, *Angew. Chem. Int. Ed*, **2004**, *43*, 5221-5224. b) Y. Wu, D. Xiong, S. Chen, Y. Wang and X. Ye, *Nat. Comm*, **2017**, *8*, 14151.
- [11] a) O. J. Plante, E. R. Palmacci, P. H. Seeberger, *Science*, **2001**, *271*, 1523-1527. b) P. H. Seeberger and W. C. Haase, *Chem. Rev*, **2000**, *100*, 4349. c) M. T. C. Walvoort, H. van den Elst, O. J. Plante, L. Kröck, P. H. Seeberger, H. S. Overkleeft, G. A. van der Marel, J. D. C. Codée. *Angew. Chem. Int. Ed. Engl*. **2012**, *51*, 4393-4396. d) C. S. Bennett, *Org. Biomol. Chem*, **2014**, *12*, 1686-1698.



- [12] a) N. Wymer and E. J. Toone, *Current Opinion in Chemical Biology*, **2000**, *4*, 110-119. b) A. M. Daines, B. A. Maltman and S. L. Flitsch, *Current Opinion in Chemical Biology*, **2004**, *8*, 106-113. c) R. M. Schmaltz, S. R. Hanson, and C. -H. Wong, *Chem. Rev.* **2011**, *111*, 4259-4307. d) Z. Wang, Z. S. Chinoy, S. G. Ambre, W. Peng, R. McBride, R. P. de Vries, J. Glushka, J. C. Paulson, G. -J. Boons, *Science*, **2013**, *341*, 379-383. e) I. A. Gagarinov, T. Li, J. S. Toraño, T. Caval, A. D. Srivastava, J. A. W. Kruijtzter, A. J. R. Heck, and G. -J. Boons, *J. Am. Chem. Soc.* **2017**, *139*, 1011-1018. f) X. Meng, W. Yao, J. Cheng, X. Zhang, L. Jin, H. Yu, X. Chen, F. Wang and H. Cao, *J. Am. Chem. Soc.*, **2014**, *136*, 5205-5208. g) L. Wen, K. Huang, M. Wei, J. Meisner, Y. Liu, K. Garner, P. G. Wang, *Angewandte Chemie*, **2015**, *127*, 12845-12849.
- [13] G. Stork, G. J. Kim, *J. Am. Chem. Soc.* **1992**, *114*, 1087-1088.
- [14] M.J. Bols, *J. Chem. Soc., Chem. Commun.* **1992**, 913-914.
- [15] Y. Ito, T. Ogawa, *Angew. Chem., Int. Ed.* **1994**, *33*, 1765-1767.
- [16] J. P. Yasomanee, A. V. Demchenko, *J. Am. Chem. Soc.* **2012**, *134*, 20097-20102.
- [17] a) J. -H. Kim, G. -J. Boons, *Angew. Chem., Int. Ed.* **2005**, *44*, 947-949. b) J. -H. Kim, H. Yang, J. Park, G. -J. Boons, *J. Am. Chem. Soc.* **2005**, *127*, 12090-12097. c) M. A. Fascione, S. J. Adshead, S. A. Stalford, C. A. Kilner, A. G. Leach, W. B. Turnbull, *Chem. Commun.* **2009**, 5841-5843. d) D. J. Cox, A. J. Fairbanks, *Tetrahedron: Asymmetry* **2009**, *20*, 773-780. e) R. A. Mensink, T. J. Boltje, *Chem. Eur. J.* **2017**, *23*, 17637-17653.
- [18] a) A. Nakagawa, M. Tanaka, S. Hanamura, D. Takahashi, K. Toshima, *Angew. Chem., Int. Ed.* **2015**, *54*, 10935-10939. b) M. Tanaka, D. Takahashi, K. Toshima, *Org. Lett.* **2016**, *18*, 5030-5033. c) D. Takahashi, M. Tanaka, N. Nishi and K. Toshima, *Carbohydr. Res.* **2017**, *452*, 64-77.
- [19] K. K. C. Liu, S. J. Danishefsky, *J. Org. Chem.* **1994**, *59*, 1895-1897.
- [20] D. Crich, *Acc. Chem. Res.* **2010**, *43*, 1144-1153.
- [21] N. Yagami, A. Imamura, *Reviews in Agricultural Science*, **2018**, *6*, 1-20.
- [22] a) L. J. van den Bos, R. E. J. N. Litjens, R. J. B. H. N. van den Berg, H. S. Overkleeft and G. A. van der Marel, *org. Lett.* **2005**, *7*, 2007-2010. b) A. E. Christina, L. J. van den Bos, H. S. Overkleeft, G. A. van der Marel and J. D. C. Codée, *J. Org. Chem.* **2011**, *76*, 1692-1706. c) A. E. Christina, J. A. Muns, J. Q. A. Olivier, L. Visser, B. Hagen, L. J. van den Bos, H. S. Overkleeft, J. D. C. Codée and G. A. van der Marel, *Eur. J. Org. Chem.* **2012**, 5729-5737.
- [23] S. Manabe, K. Ishii, Y. Ito, *J. Am. Chem. Soc.* **2006**, *128*, 10666-10667.
- [24] H. Elferink, R. A. Mensink, P. B. White, T. J. Boltje, *Angew. Chem., Int. Ed.* **2016**, *55*, 11217-11220.
- [25] K. Benakli, C. Zha, R. J. Kerns, *J. Am. Chem. Soc.* **2001**, *123*, 9461-9462.
- [26] H. Tanaka, Y. Nishiura and T. Takahashi, *J. Am. Chem. Soc.* **2006**, *128*, 7124-7125.
- [27] Y. Geng, Q. Qin and X. Ye, *J. Org. Chem.* **2012**, *77*, 5255-5270.
- [28] X. Zhu, S. Kawatkar, Y. Rao, and G. -J. Boons, *J. Am. Chem. Soc.* **2006**, *128*, 11948-11957.

## General Introduction

---

- [29] S-R. Lu, Y-H. Lai, J-H. Chen, C-Y. Liu, and K-K. T. Mong, *Angew. Chem. Int. Ed.* **2011**, *50*, 7315 – 7320.
- [30] L. Wang, H. S. Overkleeft, G. A. van der Marel, J. D. C. Codée, *J. Am. Chem. Soc.* **2018**, *140*, 4632-4638.

# 1

## Synthetic Alginate oligosaccharides

### 1.1 Introduction

Alginates are linear polysaccharides composed of D-mannuronic acid and L-guluronic acid residues, which are interconnected by (1→4) glycosidic linkages with a 1,2-*cis* configuration. Alginates are not randomly arranged but consist of segments of similar residues, that are homopolymannuronates (-MM-) and homopolyguluronates (-GG-) or segments with alternating residues (-MG-/GM-).<sup>[1]</sup> Alginates are produced by marine brown algae, such as laminaria and by bacteria, such as *Azobacter Vinelandii* and *Pseudomonas aeruginosa*. Alginates have found wide application in food industry for their favourable gelling properties and are applied among others as stabilizer and emulsifiers.<sup>[2]</sup> Alginates are also considered as interesting biomaterials and are used and investigated for

many biomedical applications. In this context it is important that alginates have shown anti-tumour, antiviral and immunomodulatory properties.<sup>[1,3]</sup> For instance, a mixture of alginate oligomers, in particular those with high (MM) content, has been shown to stimulate cytokine production from human monocytes, a process in which Toll-like receptors (TLRs) may be involved.<sup>[1a,3c,4]</sup> To establish structure-activity relations and to elucidate the mechanism of this immunomodulation and other important biological processes in which alginates are involved, well-defined fragments of alginates are needed.<sup>[5]</sup> Organic synthesis is the most straightforward approach to obtain a coherent row of well-defined alginate fragments in sufficient amounts.

The assembly of alginate oligomers by organic synthesis presents several challenges. Alginates are anionic polysaccharides containing solely uronic acids. The introduction of a carboxylic acid in each residue of the alginates chain can be accomplished following two distinct synthetic strategies; a post-glycosylation oxidation approach or a pre-glycosylation oxidation approach. In the post-glycosylation oxidation approach, the C-5 carboxylic acids are introduced at the oligomer stage by selective removal of all the C-6 hydroxyl protecting groups and subsequent oxidation of the liberated primary alcohols. In this approach, besides the need for an orthogonal protecting group that is stable during the glycosylation events and other (protecting) manipulations en route to the oligomer, the simultaneous oxidation of multiple primary alcohols to carboxylates is a major hurdle to take.<sup>[7]</sup> In the pre-glycosylation oxidation approach, the oligo/polysaccharide chain is assembled using suitably protected uronic acid building blocks. The presence of the C-5 carboxylic ester in these building blocks makes both donor and acceptor less reactive in the glycosylation reactions. Besides, possible side reactions originating from the presence of the C-5

carboxylic ester, such as epimerization and  $\beta$ -elimination can also reduce the yields of the glycosylations.<sup>[8]</sup> Both approaches share the main challenge to stereoselectively introduce 1,2-*cis* glycosidic linkages.<sup>[6]</sup> Several methods for the introduction of 1,2-*cis* glycosidic bonds have been developed (see for example the Introductory chapter) and some of these methods have been used for synthesis of alginate oligo/polysaccharides.<sup>[9]</sup>

## 1.2 Synthesis of $\beta$ -D-mannuronic acid alginates

The first synthesis of an alginate oligosaccharide, an  $\beta$ -D-mannuronic acid trisaccharide was reported by Van den Bos *et al.*<sup>[10]</sup> Three 1-thio-mannuronate esters (donors **1-3**, Table 1.1) were selected to establish their glycosylating properties in terms of reactivity and stereoselectivity. Using the pre-activation glycosylation protocol of the group of Crich, both 4-*O*-Ac donor **1** and tri-*O*-Bn donor **3** were coupled with primary and/or secondary alcohol acceptors **4**, **5** and **6** to afford 1,2-*cis* ( $\beta$ ) disaccharide products in 55-81% yield with excellent stereoselectivity (Table 1.1, entry 1, 3, 4, 5). It was hypothesized that the anomeric  $\alpha$ -triflate was stabilized by the presence of the C5-carboxylic acid ester, and that this species could undergo a  $S_N2$ -like substitution to provide the  $\beta$ -products. Contrary, coupling of the 3-*O*-Ac donor **2** with acceptor **4** gave the disaccharide with the opposite anomeric configuration (Table 1.1, entry 2). A possible explanation is the participation of the 3-*O*-Ac moiety thereby shielding attack from the  $\beta$ -side. Also, the standard NIS/TMSOTf mediated glycosylation protocol was examined by the coupling of donor **1** with acceptors **4** and **5**, to give the desired disaccharides with excellent stereoselectivity (Table 1.1, entry 6, 7). However, the stereoselectivity of the condensation of donor **1** with galacturonic acceptor **7** was moderate (Table 1.1, entry 8). With this information available,

## Chapter 1

1-thio-mannuronic acid donor **7** was applied in the synthesis of spacer containing mannuronic acid trisaccharide **13**, using the NIS/TMSOTf mediated glycosylation protocol (Scheme 1.1).

**Table 1.1** Glycosylation of 1-thio mannuronic acid donors **1**, **2** and **3**.

entry	donor	acceptor	yield	α/β	entry	donor	acceptor	yield	α/β
1 <sup>[a]</sup>	<b>1</b>	<b>4</b>	81%	1/>10	5 <sup>[a]</sup>	<b>1</b>	<b>6</b>	71%	1/>10
2 <sup>[a]</sup>	<b>2</b>	<b>4</b>	66%	1/0	6 <sup>[b]</sup>	<b>1</b>	<b>4</b>	91%	1/>10
3 <sup>[a]</sup>	<b>3</b>	<b>5</b>	55%	1/>10	7 <sup>[b]</sup>	<b>1</b>	<b>5</b>	58%	1/>10
4 <sup>[a]</sup>	<b>1</b>	<b>5</b>	69%	1/>10	8 <sup>[b]</sup>	<b>1</b>	<b>7</b>	99%	1/2

[a] Ph<sub>2</sub>SO/Tf<sub>2</sub>O; [b] NIS/TMSOTf.

Condensation of 1-thio mannuronic acid donor **8** with acceptor **9** afforded the 1,2-*cis* disaccharide product **10** in 78% yield. Subsequent delevulinoylation delivered disaccharide acceptor **11**, which was coupled with donor **8** to give the all-*cis* trisaccharide **12** in 50%. After global deprotection, target trisaccharide **13** was obtained in 35% yield over the three final steps.

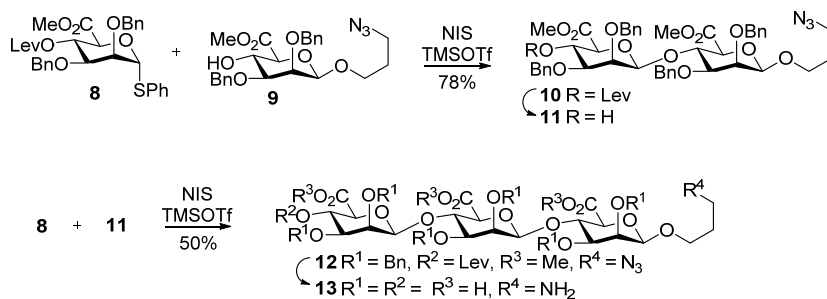

**Scheme 1.1** Synthesis of an alginate trisaccharide.

The high stereoselectivity of the mannuronate ester donors to give 1,2-*cis*-linked products initiated several studies to the underlying mechanism.<sup>[11]</sup> First, it was shown that the stereoselectivity of the glycosylations are independent of the applied donor (thioglycosides, carboxylbenzyl and *N*-phenyl trifluoroacetimidate donors) and the activation protocol, as all condensations proceeded in a 1,2-*cis*-manner.<sup>[11a]</sup> To establish the stereodirecting effect of the C5-carboxylate ester, the stripped pyranosyl uronate ester donor **14** and its “non-oxidized” counterpart **15** donor were coupled with a range of acceptors of varying size (Scheme 1.2 A). Although the selectivity in the coupling reactions depended on the steric demands of the nucleophile, the highly 1,5-*cis*-directing influence of the C5-carboxylate ester in **14** became obvious. This outcome was explained by postulating that the reaction proceeds via an S<sub>N</sub>1-type mechanism, in which two half-chair oxocarbenium ions **14-I/15-I** and **14-II/15-II** act as product-forming intermediates. The incoming nucleophile will preferentially attack the half chairs from the face that leads to a chair-like transition state, as opposed to the higher energy twist-boat transition state that would result from attack on the opposite face. The *pseudo*-axially oriented C5-carboxylate ester stabilizes the half-chair oxocarbenium ion intermediate **14-I** by through-space

interaction of the electron-rich carbonyl function with the anomeric cation and by minimizing the electron-withdrawing effect of the carboxylate ester. Combining the favorable axial orientation of the C5 carboxylate ester with the preferred orientation of alkoxy substituents at the C2, C3 and C4 positions the most stable half-chair conformer of the manuronate ester oxocarbenium ion can be estimated. Alkoxy groups at the C3 and C4 preferentially take up axial positions to allow through-space stabilization of the anomeric cation, while C2-alkoxy groups prefer an equatorial position to enable hyperconjugative stabilization by the axial C-H  $\sigma$  bond. On this basis, manuronate ester oxocarbenium conformer **1-I** is much more stable than conformer **1-II**, because all substituents in the  ${}^3\text{H}_4$  conformer **1-I** occupy a preferred position whereas all substituents in the  ${}^4\text{H}_3$  conformer **1-II** are in an unfavorable position (Scheme 1.2 B).<sup>[11a]</sup> Nucleophilic attack on the  $\beta$ -face of the  ${}^3\text{H}_4$  conformer leads to the formation of the 1,2-*cis*- $\beta$ -mannuronate ester products (Scheme 1.2 B). These findings are supported by low-temperature NMR experiments. Monitoring the activation of mannosazide uronate **18** showed the formation of a conformational mixture of anomeric triflates in which the  ${}^1\text{C}_4$  chair conformer **18a\*** dominated. Both the electron-withdrawing triflate at C-1 and the methyl ester at C-5 render the anomeric center of the manuronate triflate so electron-depleted that the structure of the covalent triflate approaches the conformation of the oxocarbenium ion  ${}^3\text{H}_4$  half-chair **18-I** (Scheme 1.2 C).<sup>[11b,11g]</sup> Further support was found in the NMR spectroscopic and X-ray crystallographic analysis of manuronate lactone **20**, the C-1 of which carries a partial positive charge and which is  $\text{sp}^2$ -hybridized. This lactone adopts a flattened  ${}^1\text{C}_4$  chair, very similar to the  ${}^3\text{H}_4$  half-chair, at room temperature (Scheme 1.2 C).<sup>[11b]</sup>



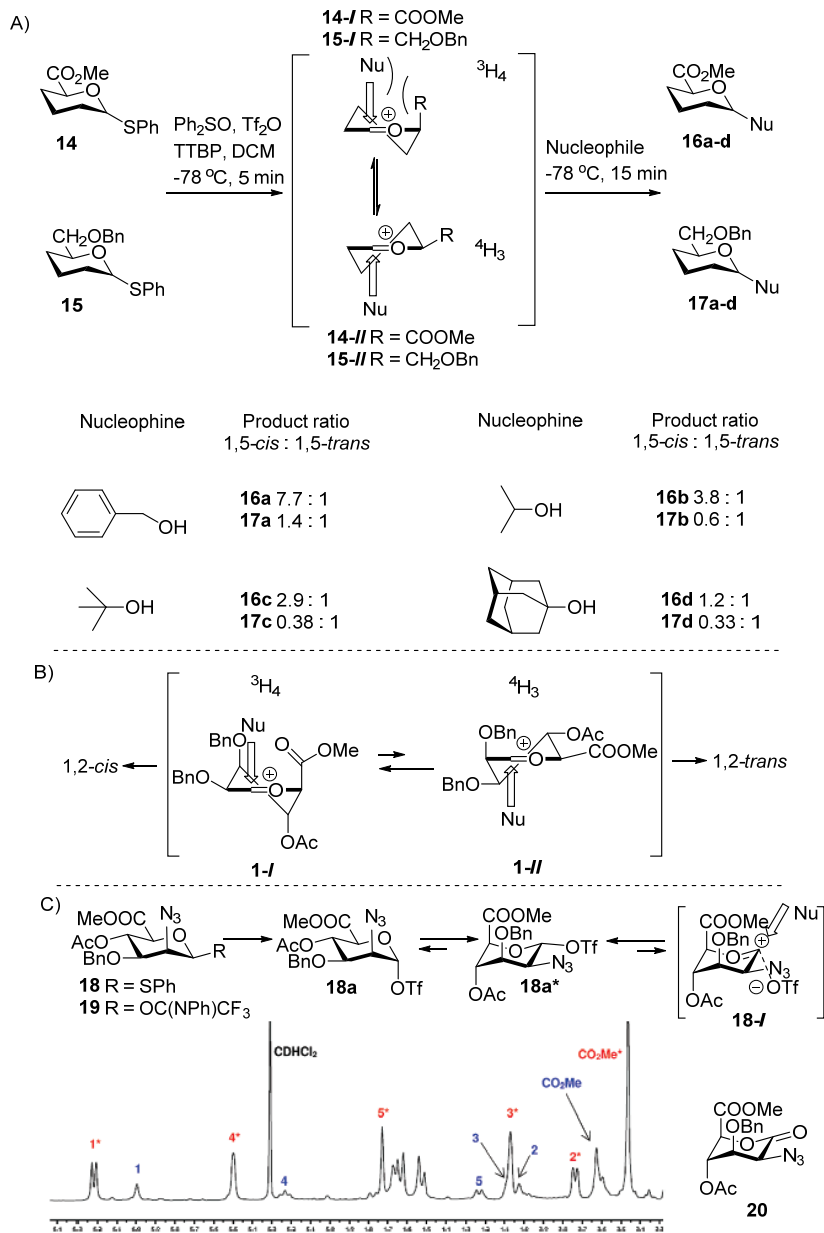

**Scheme 1.2** A): Oxocarbenium ions of “stripped” uronate ester **14** and its benzyloxymethyl counterpart **15**; B): the mannuronic acid oxocarbenium ion; C): part of the  $^1\text{H}$  NMR spectrum obtained after activation of mannuronic acid ester **18** and **19**; and the structure of lactone **20**.

Next, the scope of the method to prepare  $\beta$ -D-mannuronic acid alginate oligosaccharides in solution phase was investigated (Scheme 1.3 A).<sup>[11a]</sup> In a chemoselective coupling approach, thiomannoside donors **21** and **3** were coupled with thiomannoside acceptor **24** to give disaccharide thiodonors **25** and **26**, respectively. The moderate yield of these glycosylations can be explained by activation of the thiomannosyl acceptor and/or the dimer products. Conversion of thiomannoside donors **21** and **3** into carboxylbenzyl (CB) donors **22** and **23**, allowed for an orthogonal glycosylation approach and the desired disaccharides **25** and **26** were both obtained in 65% yield, with excellent 1,2-*cis*-selectivity. The spacer containing disaccharides **10** and **27** were synthesized in 62% and 67% yield by condensation of **9** with thiomannoside donors **21** and **3**, using the 1-benzenesulfinyl piperidine BSP/Tf<sub>2</sub>O couple instead of the Ph<sub>2</sub>SO/Tf<sub>2</sub>O activator. Removal of the levulinoyl group in dimer **10** provided acceptor **11**. Disaccharide donors **25** and **26** were coupled with monosaccharide acceptor **9** and disaccharide acceptor **11** to yield desired trisaccharides **28** and **12** (74% and 51% yield respectively) and tetrasaccharide **29** (67% yield) with good stereoselectivity again. The pentasaccharide **30** was obtained from the [2+3] coupling in 69% yield and excellent stereoselectivity. Fully protected **27**, **28**, **31** and **30** were subjected to saponification and subsequent hydrogenolysis to give the target di-, tri-, tetra- and pentamer (**32**, **13**, **33** and **34**).

The high 1,2-*cis* selectivity of mannuronate donors was an incentive to explore a solid-phase synthesis. Walvoort *et al.* reported the automated solid-phase synthesis of an alginate tetramer **39**, octamer **40** and dodecamer **41** using monomannuronic acid imidate donor **35**. Three equivalents of donor **35** in combination with TfOH as activator and three repetitive coupling cycles gave an efficiency/yield per coupling step of 90% (Scheme 1.3

B).<sup>[11c]</sup> Metathesis mediated cleavage of the oligomers from the solid support led to the isolation of crude reaction mixtures, containing approximately 90%, 55% and 40% of the desired all-*cis*-products of the partially protected alginate tetramer **36**, octamer **37** and dodecamer **38**, respectively.

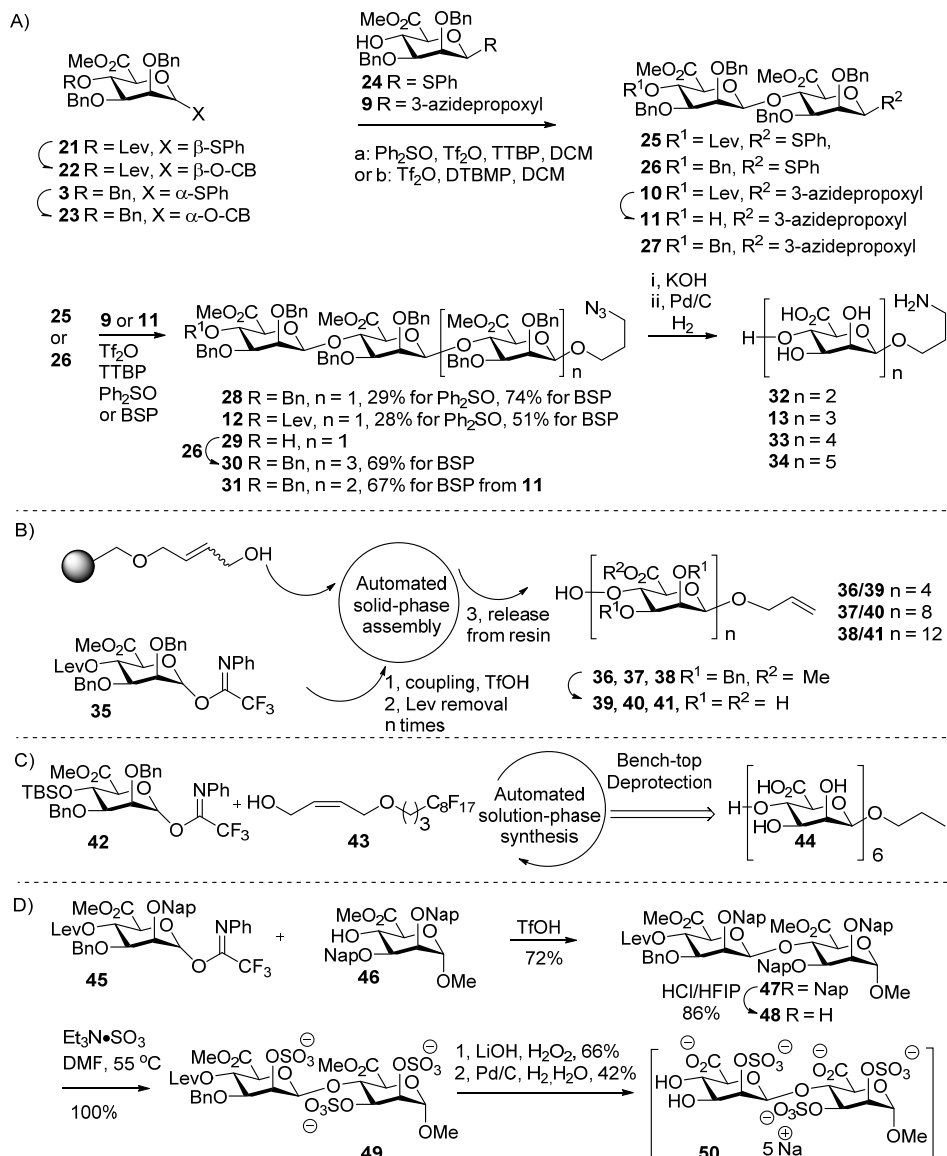

Scheme 1.3 Synthesis of the alginate oligosaccharides.

Pohl and coworkers synthesized  $\beta$ -D-mannuronic acid alginate oligomers up to the hexasaccharide **44** from monomannuronic acid imidate donor **42** by utilizing a strategy employing fluororous-tag assisting purification in 7% yield over 9 steps (75% average yield per reaction step and 56% efficiency/yield per coupling cycle, see Scheme 1.3C).<sup>[11e]</sup> Recently, Volbeda *et al.* synthesized a sulfated  $\beta$ -D-mannuronic acid alginate disaccharide **50** by use of mannuronic acid imidate donor **45** (Scheme 1.3D).<sup>[11f]</sup> The disaccharide **47** was synthesized from donor **45** and acceptor **46** in 72%. The 2-naphthylmethyl (Nap) protecting group was chemoselectively removed by using a new protocol employing a catalytic amount of HCl in hexafluoro-2-propanol. Three sulfate groups were installed using  $\text{SO}_3 \cdot \text{Et}_3\text{N}$ , and ensuing saponification and final debenzoylation gave the desired sulfated  $\beta$ -D-mannuronic acid alginate disaccharide **50**.

Utilizing a post-glycosylation oxidation approach, Huang and Jiang assembled an oligo- $\beta$ -(1-4)-D-mannuronic acid neoglycolipid (Scheme 1.4).<sup>[11h]</sup> Building on the stereoselectivity of the benzylidene mannose technology of Crich, **57** and dimer **58** were generated and further functionalized into the neoglycolipid **63** and dimer **64**.

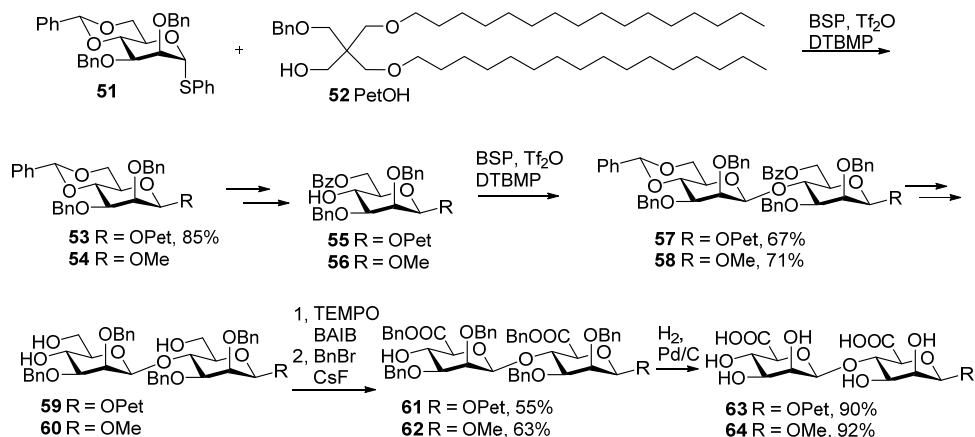

Scheme 1.4 Synthesis of  $\beta$ -(1-4)-oligo-D-mannuronic acid neoglycolipids.

### 1.3 Synthesis of $\alpha$ -L-guluronic acid alginate

Short oligomers of  $\alpha$ -L-guluronic acid alginate have been synthesized by two groups.<sup>[12,13]</sup>

Dinkelaar *et al.* described an evaluation of the glycosylating properties of gulose and guluronate ester donors and the first synthesis of a guluronic acid trimer (Scheme 1.5A and Table 1.2).<sup>[12]</sup> Key compound  $\beta$ -S-phenyl-gulopyranose **70** was obtained from L-gulonic acid  $\gamma$ -lactone **65** on 500 mmol scale (100 g) with only one chromatographic purification. Starting from compound **70**, guluronate donors (**72** and **74**), gulose donors (**71**, **73**, **75** and **76**) and acceptors (**81** and **82**) were obtained (Table 1.2). The glycosylating properties of guluronate donors (**72** and **74**), gulose donors (**71**, **73**, **75** and **76**) were examined using acceptors **77-82** (Table 1.2). This study shows that the presence of the carboxylic acid ester at C-5 in the guluronate donors does not contribute favorably to the formation of the 1,2-*cis*-gulosidic linkage. The best  $\alpha$ -selectivity was obtained by the 2,3-di-*O*-benzyl-4,6-*O*-silylidine-1-thioguloside donor **76**. It is important to note that the poor nucleophilicity of the hydroxyl group at C-4 in gulose acceptor **82** and especially in guluronic acceptor **81**

reduced the yield of the glycosylations (Table 1.2).

**Table 1.2** Glycosylations of guluronate donors (**72** and **74**), glucose donors (**71**, **73**, **75** and **76**).

Entry	Donor	Acceptor	Yield(%)	( $\alpha/\beta$ )	Entry	Donor	Acceptor	Yield(%)	( $\alpha/\beta$ )
1	<b>71</b> <sup>[a]</sup>	<b>77</b>	71	13:1	9	<b>74</b> <sup>[b]</sup>	<b>80</b>	77	1:3
2	<b>71</b> <sup>[a]</sup>	<b>78</b>	91	10:1	10	<b>74</b> <sup>[b]</sup>	<b>81</b>	34	3:1
3	<b>71</b> <sup>[a]</sup>	<b>79</b>	73	>20:1	11	<b>73</b> <sup>[a]</sup>	<b>80</b>	86	3:1
4	<b>72</b> <sup>[b]</sup>	<b>77</b>	73	3:1	12	<b>73</b> <sup>[a]</sup>	<b>82</b>	48	6:1
5	<b>72</b> <sup>[b]</sup>	<b>78</b>	94	>20:1	13	<b>75</b> <sup>[a]</sup>	<b>80</b>	88	3:1
6	<b>72</b> <sup>[b]</sup>	<b>79</b>	79	10:1	14	<b>75</b> <sup>[a]</sup>	<b>82</b>	45	6:1
7	<b>74</b> <sup>[b]</sup>	<b>77</b>	66	1:3	15	<b>76</b> <sup>[a]</sup>	<b>80</b>	75	5:1
8	<b>74</b> <sup>[b]</sup>	<b>78</b>	64	>20:1	16	<b>76</b> <sup>[a]</sup>	<b>82</b>	48	10:1

[a] Ph<sub>2</sub>SO, TTBP, CH<sub>2</sub>Cl<sub>2</sub>, -78 °C, Tf<sub>2</sub>O, 10 min, nucleophile, to 0 °C. [b] Ph<sub>2</sub>SO, TTBP, CH<sub>2</sub>Cl<sub>2</sub>, -45 °C, Tf<sub>2</sub>O, 10 min, then -78 °C, nucleophile, to 0 °C.

It was decided to use a dehydrative condensation strategy because this glycosylation approach is well suited to couple unreactive nucleophiles. Hemiacetal donor **83**, prepared by hydrolysis of thioglucose **76**, was coupled with acceptor **82** to yield disaccharide **84** with excellent  $\alpha$ -selectivity (Scheme 1.5A). Removal of the 4,6-*O*-silylidine group and protection of C6-hydroxyl gave disaccharide acceptor **86**. Subsequent dehydrative coupling of **86** with hemiacetal donor **83** afforded  $\alpha$ -trisaccharide **87** with excellent stereoselectivity but in a moderate 42% yield. Having fully protected dimer **86** and trimer **87** available the target  $\alpha$ -L-guluronic acid alginate fragments **88** and **89** were prepared by desilylation, subsequent selective oxidation of primary C-6 hydroxyl and final hydrogenolysis.<sup>[12]</sup>

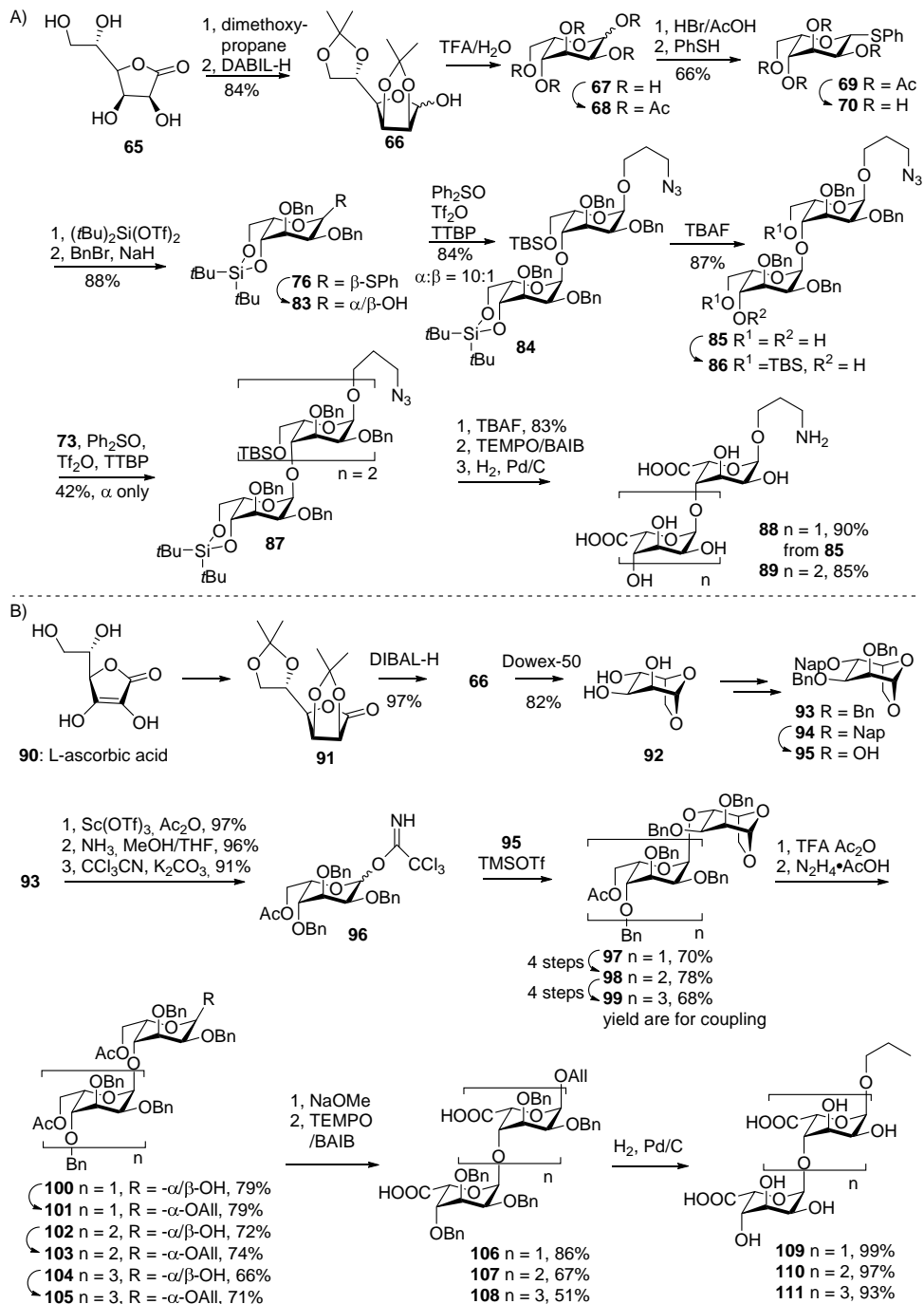

Scheme 1.5. Synthesis of α-L-guluronic acid alginate.

Hung and coworkers circumvented the low nucleophilicity of the gulose acceptors by the application of 1,6-anhydro- $\beta$ -L-gulopyranosyl-4-alcohol **95**, which places the C-4 hydroxyl in a more accessible position. Acceptor **95** was synthesized from L-ascorbic acid **90** in an efficient way as depicted in Scheme 1.5B.<sup>[13]</sup> Trichloroacetimidate donor **96** was generated from tri-benzyl 1,6-anhydro- $\beta$ -L-gulopyranose **93** by sequential acetolysis, anomeric deacetylation and trichloroacetimidation. Condensation of **96** with acceptor **95** afforded the expected disaccharide **97** in 70% yield ( $\alpha$ : $\beta$  = 4:1). Conversion of **97** into hemiacetal **100** was achieved by cleavage of the 1,6-anhydro ring in **97** with TFA and Ac<sub>2</sub>O followed by anomeric deacetylation with N<sub>2</sub>H<sub>4</sub>·HOAc. Coupling of the the anomeric hydroxyl in **86** with allyl bromide via Williamson etherification using potassium tert-butoxide as a base furnished the  $\alpha$ -linked dimer **101** (79%) as a single product. Contrary, condensation of the imidate donor, obtained by trichloroacetimidation of **100**, with allyl alcohol yielded 8% of the desired  $\alpha$ -dimer **101** and 68% of the undesired  $\beta$ -dimer. The synthesis of fully protected trimer **103** and tetramer **105** was completed by the same sequence of events (elongation with donor **96**, 1,6-anhydro ring opening, O1-deacetylation and O1-allylation). Finally, the target  $\alpha$ -L-guluronic acid alginate dimer **109**, trimer **110** and tetramer **111** were obtained from compounds **101**, **103**, and **105** by deacetylation, oxidation of primary alcohol and hydrogenolysis.<sup>[13]</sup>

### 1.4 Conclusion

$\beta$ -D-mannuronic acid alginate oligosaccharides up to the dodecasaccharide were assembled by use of newly developed mannuronate ester donors. Glycosylations using these mannuronate ester donors proceed with excellent 1,2-*cis*-selectivity both in solution and automated solid phase syntheses. With the objective to explain the origin of this 1,2-



*cis*-selectivity details of the underlying reaction mechanism have been elucidated. Whereas a pre-glycosylation oxidation approach is the most efficient in the construction of mannuronic acid alginate oligosaccharides,  $\alpha$ -L-guluronic acid alginate oligosaccharides are best accessible by a post-glycosylation oxidation approach. Two successful strategies have been developed. One comprises elongation from the non-reducing to the reducing end using 1,6-anhydro- $\beta$ -L-gulopyranosyl-4-alcohol as a repeating glycosyl acceptor and the other one comprises elongation from the reducing to the non-reducing end using a 2,3-di-*O*-Bn-4,6-*O*-silylidene hemiacetal gulose donor. In chapter 4 of this thesis the first synthesis of mixed-sequence alginate oligosaccharides, featuring both  $\beta$ -D-mannuronic acids (M) and  $\alpha$ -L-guluronic acid (G), is described.

## 1.5 References

- [1] a) T. H. Flo, L. Ryan, E. Latz, O. Takeuchi, B. G. Monks, E. Lien, Ø. Halaas, S. Akira, G. Skjåk-Bræk, D. T. Golenbock, T. Espevik, *J. Biol. Chem*, **2002**, *277*, 35489-35495; b) B. H. A. Rehm, S. Valla, *Appl. Microbiol. Biotechnol*, **1997**, *48*, 281-288.
- [2] a) S. T. Moe, K. I. Draget, G. Sjøk-Bræk, O. Smidsrød, in *Food Polysaccharides and Their Applications*, (Ed: Stephen, A. M.); Marcel Dekker, Inc.; New York, **1995**, p. 245-286; b) J. Sun, H. Tan, *Materials*, **2013**, *6*, 1285-1309.
- [3] a) V. L. Campodónico, N. J. Llosa, L. V. Bentancor, T. Maira-Litran, G. B. Pier, *Infect. Immun*, **2011**, *79*, 3455-3464; b) D. M. Ramsey, D. J. Wozniak, *Mol. Microbiol*, **2005**, *56*, 309-322; c) M. Iwamoto, M. Kurachi, T. Nakashima, D. Kim, K. Yamaguchi, T. Oda, Y. Iwamoto, T. Muramatsu, *FEBS Lett*, **2005**, *579*, 4423-4429.
- [4] C. A. Janeway, R. Medzhitov, *Annu. Rev. Immunol*, **2002**, *20*, 197-216.
- [5] a) F. Wolfram, E. N. Kitova, H. Robinson, M. T. C. Walvoort, J. D. C. Codée, J. S. Klassen, P. L. Howell, *J. Biol. Chem*, **2014**, *289*, 6006-6019; b) P. Baker, T. Ricer, P. J. Moynihan, E. N. Kitova, M. T. C. Walvoort, D. Little, J. C. Whitney, K. Dawson, J. T. Weadge, H. Robinson, D. E. Ohman, J. D. C. Codée, J. S. Klassen, A. J. Clarke, P. L. Howell, *PLoS Pathog*, **2014**, *10*, e1004334.
- [6] D. Takahashi, M. Tanaka, N. Nishi and K. Toshima, *Carbohydr. Res*, **2017**, *452*, 64-77.
- [7] a) W. Yang, S. Ramadan, B. Yang, K. Yoshida and X. Huang, *J. Org. Chem*, **2016**, *81*, 12052-12059; b) L. Huang, N. Teumelsan and X. Huang, *Chem. Eur. J*, **2006**, *12*, 5246-5252; c) B. Hagen, J.

## Chapter 1

---

- Hessel, M. van Dijk, Q. Zhang, H.S. Overkleeft, G. A. van der Marel and J. D. C. Codée, *Org. Lett*, **2017**, *19*, 2514-2517.
- [8] J. D. C. Codée, A. E. Christina, M. T. C. Walvoort, H. S. Overkleeft and G. A. Van den Marel, *Top Curr Chem*, **2011**, *301*, 253-289.
- [9] See general introduction of this thesis.
- [10] L. J. van den Bos, J. Dinkelaar, H. S. Overkleeft, G. A. van der Marel, *J. Am. Chem. Soc*, **2006**, *128*, 13066-13067.
- [11] a) J. D. C. Codée, L. J. van den Bos, A.R. de Jong, J. Dinkelaar, G. Lodder, H. S. Overkleeft, G. A. van der Marel, *J. Org. Chem*, **2009**, *74*, 38-47; b) M. T. C. Walvoort, G. Lodder, J. Mazurek, H. S. Overkleeft, G. A. van der Marel, J. D. C. Codée, *J. Am. Chem. Soc*, **2009**, *131*, 12080-12081; c) M. T. C. Walvoort, H. van den Elst, O. J. Plante, L. Kröck, P. H. Seeberger, H. S. Overkleeft, G. A. van der Marel, J. D. C. Codée, *Angew. Chem., Int. Ed. Engl*, **2012**, *51*, 4393-4396; d) J. D. C. Codée, M. T. C. Walvoort, A. R. de Jong, J. Dinkelaar, G. Lodder, H. S. Overkleeft, G. A. van der Marel, *J. Carbohydr. Chem*, **2011**, *30*, 438-457; e) S. L. Tang, N. L. B. Pohl, *Org. Lett*, **2015**, *17*, 2642-2645; f) A. G. Volbeda, H. A. V. Kistemaker, H. S. Overkleeft, G. A. van der Marel, D. V. Filippov, J. D. C. Codée, *J. Org. Chem*, **2015**, *80*, 8796-8806; g) M. T. C. Walvoort, J. Dinkelaar, L. J. van den Bos, G. Lodder, H. S. Overkleeft, J. D. C. Codée, G. A. van der Marel, *Carbohydr. Res*, **2010**, *345*, 1252-1263; h) Z. Jiang, R. Xu, C. Wilson and A. Brenk, *Tetrahedron Lett*, **2007**, *48*, 2915-2918.
- [12] J. Dinkelaar, L. J. van den Bos, W. F. J. Hogendorf, G. Lodder, H. S. Overkleeft, J. D. C. Codée, G. A. van der Marel, *Chem. Eur. J*, **2008**, *14*, 9400-9411.
- [13] F. -C. Chi, S. S. Kulkarni, M. M. L. Zulueta, S. -C. Hung, *Chem. Asian J*, **2009**, *4*, 386-390.

## Synthetic Zwitterionic Polysaccharides

Published in: *Current Opinion in Chemical Biology*, 2017, 40, 95-101.

### 2.1 Zwitterionic polysaccharides: structure and activity

Bacteria are generally covered in polysaccharides featuring rare monosaccharide constituents and structural elements that differ from the mammalian glycan repertoire.<sup>[1]</sup> As such they represent excellent targets for the (human) innate and adaptive immune system to respond to.<sup>[2]</sup> However, bacterial polysaccharides behave poorly as stand-alone vaccine entities. Carbohydrates in general are poor immunogens and only trigger B-cell mediated IgM response, without switching to IgG production and memory development. Thus, in designing carbohydrate-based vaccines, bacterial oligo/polysaccharides are conjugated to a carrier protein to induce T-cell response to peptide epitopes embedded in

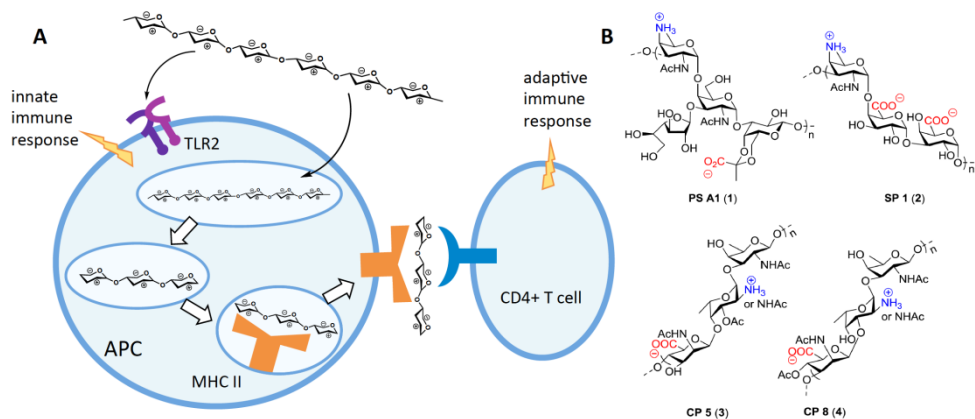

**Figure 2.1** Zwitterionic polysaccharides. A) ZPS can stimulate the innate and adaptive arm of the immune system through interaction with TLR2 and by binding to MHC II, respectively. B) Examples of naturally occurring ZPS from *Bacteroides fragilis* (PS A1, **1**), *Streptococcus pneumoniae* (SP1, **2**), *Staphylococcus aureus* (type 5, **3** and type 8, **4**).

the carrier protein.<sup>[3,4,5]</sup> This holds not true however for a unique class of carbohydrates that are characterized by the presence of both positively and negatively charged functionalities: the zwitterionic polysaccharides (ZPSs). These bacterial polysaccharides feature amino groups, protonated at physiological pH, and carboxylates or phosphates that are negatively charged at neutral pH. It is now well established that these unique structural features endow these saccharides with exceptional immunological properties.<sup>[6]</sup> Zwitterionic polysaccharides are T-cell dependent antigens as they can be processed by antigen presenting cells, loaded onto MHC II molecules and presented to T-cells, and thus are able to elicit an immune response.<sup>[7]</sup> As such, ZPSs behave like foreign proteins and this surprising activity has been shown to arise from their unique structural elements.<sup>[8,9]</sup> Besides their activity in the adaptive part of the immune system, ZPS also interact with the innate arm of our immune system: various ZPS have been implied to interact with Toll like

receptor (TLR) 2.<sup>[10,11]</sup> Figure 2.1 represents the structures of the most prominent ZPSs: PS A1 from *Bacteroides fragilis* (**1**),<sup>[7]</sup> the *Streptococcus pneumoniae* Sp1 saccharide (**2**)<sup>[7]</sup> and the capsular polysaccharides of *Staphylococcus aureus* type 5 (**3**) and type 8 (**4**).<sup>[12]</sup> Most mechanistic work on these ZPS has been conducted with ZPS **1** and **2**, isolated from the parent bacteria. Chemical modification of the isolated material (acetylation of the amines to remove the positive charge, reduction of the carboxylates) has shown the prerequisite of the zwitterionic motif for activity.<sup>[6]</sup> NMR studies combined with molecular dynamic calculations and supported by circular dichroism (CD) measurements revealed that ZPS **1** and **2** take up a helical structure, positioning their positive and negative charges at approximately equal distance.<sup>[13,14,15]</sup>

Because of the appealing biological activities and their unique structures, the ZPSs have been the subject of several synthetic endeavors.<sup>[16-27]</sup> Given the structural features of the target molecules (*cis*-glycosidic linkages, the presence of multiple functional groups, *i.e.* amines, acetamides, carboxylates and the rare monosaccharide constituents), these total synthesis campaigns have not been without a challenge. This chapter presents an overview of the accomplished syntheses to date and the - limited - biological data that has been gathered with the resulting zwitterionic oligosaccharides.

## 2.2 Zwitterionic polysaccharides: synthesis

Several synthetic routes towards fragments of the ZPS depicted in Figure 2.1B have been disclosed. Because the synthesis strategies towards capsular polysaccharides of *S. aureus* are not compatible with the incorporation of free, positively charged amine functionalities (next to the acetamides) in the generated fragments<sup>[23-27]</sup> these syntheses will not be reviewed here. The overview of the successful syntheses of Sp1 and PS A1 fragments clearly illustrate the challenges associated with the complex structures of these molecules. One of the bottlenecks in the assembly of these structures is represented by the requirement of sufficient amounts of a suitably functionalized trideoxydiaminogalactose (TDDAG) building block. A recent review details the variant approaches taken to generate such building blocks.<sup>[30]</sup>

### 2.2.1 Synthesis of Sp1 polysaccharide fragments

The Sp1 polysaccharide is built up from trimer repeats composed of  $\alpha$ -D-2-*N*-acetamido-4-amino-2,4,6-trideoxy-D-galactopyranose and  $\alpha$ -D-galacturonic acid residues (See Figure 2.1B). The presence of the rare TDDAG and galacturonic acid (GalA) residues and the fact that they are all interconnected through *cis*-glycosidic linkages present a huge synthetic challenge. Bundle and co-workers were the first to complete the assembly of a fragment of this ZPS.<sup>[16]</sup> They reported the synthesis of a monomer and dimer of the repeating trisaccharide as depicted in Figure 2.2. The TDDAG motif was generated from a rather advanced disaccharide synthon (**7** to **8**). After coupling with galactose donor **10**, the trisaccharide **12** was obtained. Of this intermediate the primary alcohol functions were unmasked to set the stage for the double oxidation step. The two carboxylates were installed using a TEMPO/NaOCl oxidation procedure, after which global

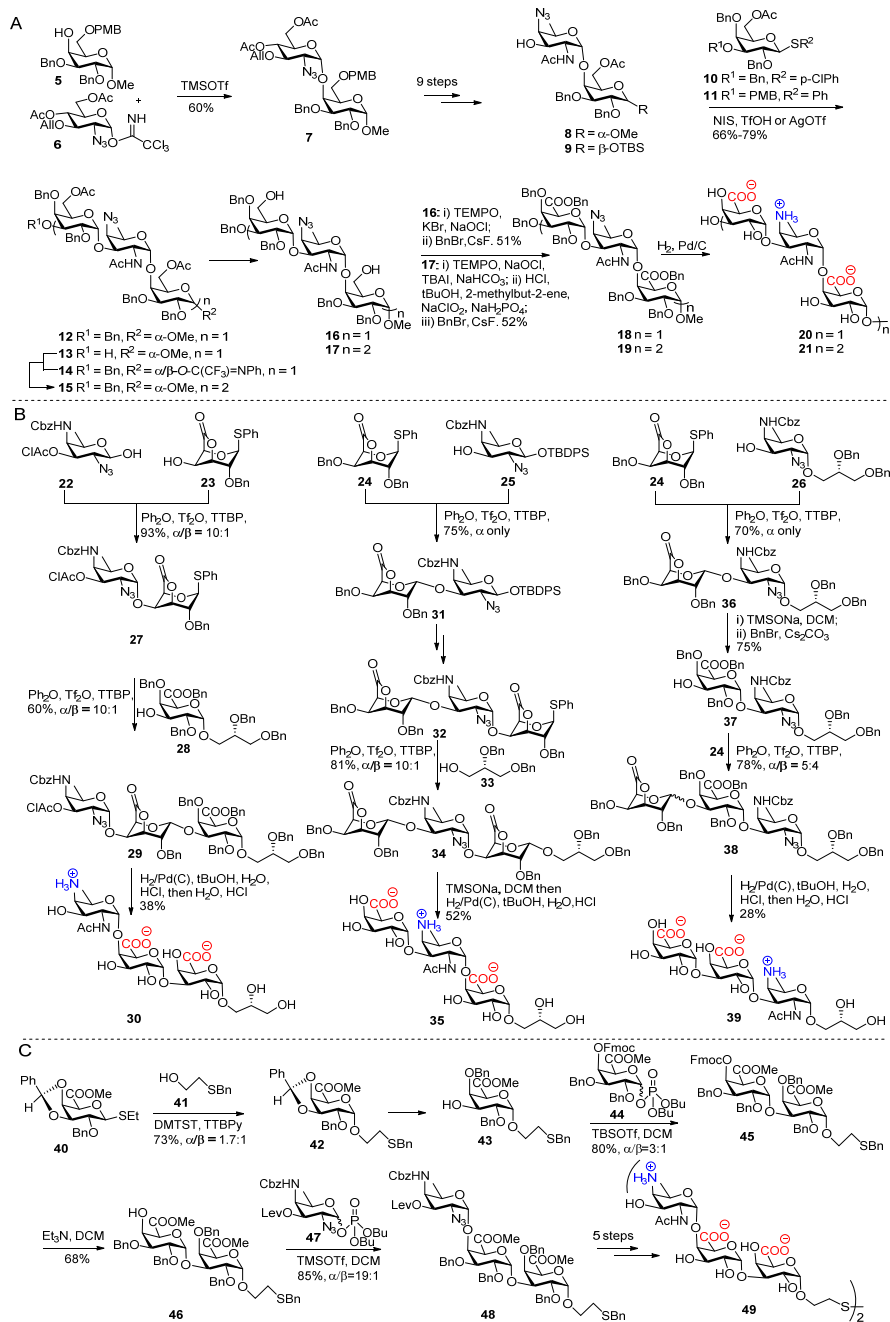

**Figure 2.2** Syntheses towards fragments of ZPS Sp1. A) Approach by Bundle and co-workers generating a trisaccharide and a hexasaccharide. B) GalA-[3,6]-lactones in the synthesis of all three repeating units of Sp1. C) Assembly of Sp1 ready for conjugation.

deprotection of the trisaccharide was accomplished by a catalytic hydrogenation event. The assembly of the hexasaccharide, encompassing two repeating units, required the generation of a new trisaccharide. Again, a disaccharide synthon (**9**) was generated, this time bearing an anomeric *tert*-butyldimethyl (TBS) group as a temporary protecting, to allow for the generation of a trisaccharide donor (**14**). The crucial condensation of the trisaccharide donor **14** and acceptor **13** required careful tuning of the reaction conditions and hexasaccharide **15** could be obtained in 85% yield. Deacetylation of **15** then provided the tetraol, ready for the crucial oxidation step. Complete oxidation of the tetraol **17** proved more difficult than the corresponding oxidation of diol **16**. It is commonly observed in the assembly of uronic acid containing oligosaccharides that it is significantly more challenging to perform multiple oxidations on a large substrate than to oxidize smaller fragments. Using Huang's oxidation procedure that entails a biphasic TEMPO oxidation, followed by a Pinnick oxidation of the formed aldehydes, the tetra uronic acid was obtained. After benzylation of the esters the hexasaccharide **19** could be purified and it was obtained in 52% yield starting from tetra-acetate **15**. A single hydrogenation event then delivered the target hexasaccharide **21**. The authors report that the tri- and hexasaccharide **20** and **21**, respectively, were evaluated for their T-cell activating capacity but that no activity was found. However, no details for these experiments have been disclosed. It has been postulated that ZPSs take up helical shapes and that this 3-dimensional structure may be relevant for the unique MHC-II binding capacity of the ZPSs. The NMR spectra of the tri- and hexasaccharide **20** and **21** were compared to the NMR of the native polysaccharide. Although there were clear similarities between the spectra, also significant differences were observed, indicating that the structures of the synthesized



fragments were quite distinct from their polymeric counterpart. Given the synthetic challenges that were encountered, Bundle and co-workers reached the conclusion that the solution to the question what the minimal structure is for MHC-II binding will not be delivered through an organic synthesis approach.

After this first synthetic effort, Christina *et al.* described the assembly of the three unique trimer repeats of the Sp1 ZPS (see Figure 2.2B).<sup>[17]</sup> To circumvent the challenges associated with late stage introduction of multiple carboxylates, to tackle the generally poor reactivity of galacturonic acid acceptors and to install the desired  $\alpha$ -GalA linkages in a stereoselective manner, galacturonic acid lactone synthons **23** and **24** were produced. GalA-[3,6]-lactones are reactive GalA donors that normally provide condensation products in excellent *cis*-selectivity. The lactone bridge in GalA **23** places the C4-OH in a reactive and accessible equatorial position, which explains productive couplings with this building block. As depicted in figure 2.2B, the three trimer repeats **30**, **35** and **39** were assembled through a modular approach employing building blocks **22-26** and spacer **33**. All glycosylations towards the three trimer repeats proceeded in good yield and stereoselectivity, except for the condensation of donor **24** and acceptor **37**. The reason for the poor selectivity in the latter glycosylation is not clear. This result does indicate that the use of a GalA-TDDAG-GalA trisaccharide building block with a GalA-[3,6]-lactone donor moiety is not attractive to assemble larger Sp1 oligosaccharides. Nonetheless, the GalA-[3,6]-lactones have proven their merits in these syntheses. No biological evaluation of the trisaccharides has been reported yet.

Schumann *et al.* reported on the synthesis of a Sp1 trisaccharide, functionalized with a thiol handle for conjugation purposes. As depicted in Figure 2.2C, they built the

trisaccharide from the monomeric building blocks **40**, **44** and **47**. The TDDAG building block was assembled using a *de novo* approach.<sup>[18]</sup> The trisaccharide chain was built up by first condensing mercaptoethanol spacer **41** and GalA donor **40**. This glycosylation proceeded with poor selectivity to give the spacer-GalA building block **42** in 73% ( $\alpha/\beta = 1.7 : 1$ ). After regioselective benzylidene ring opening the resulting GalA was coupled with donor **44** again with moderate stereoselectivity. After Fmoc-removal the TDDAG building block was attached to give the fully protected trisaccharide. Unmasking of the trimer required the exchange of the C3"-levulinoyl (Lev) ester for a benzyloxymethyl (BOM) ether, to prevent base mediated carbamate formation on the TDDAG moiety, a side reaction also observed by Christina *et al.*<sup>[17]</sup> After installation of the acetamides, Birch reduction provided the desired trimer as a disulfide. This trisaccharide was used to interrogate rabbit sera raised against the Sp1 polysaccharide in a microarray binding study. To this end disulfide **49** was reduced *in situ* and coupled to a maleimide functionalized micro array glass slide. Binding was observed between the immobilized synthetic trisaccharide and the serum indicating that structural elements of the polysaccharide that are recognized by antibodies in the serum are also present in the trisaccharide. The structure was not recognized by serum raised against PS A1 (*vide infra*).

### 2.2.2 Synthesis of PS A1 polysaccharide fragments

To date only two synthetic approaches have been reported towards the assembly of the ZPS of *Bacteroides fragilis*, PS A1. Just like Sp1 saccharide, the PS A1 ZPS is built up from galactose configured monosaccharides and contains the TDDAG residue as well. As shown in Figure 2.1B, next to the TDDAG, it contains a GalNAc, a galactofuranose (Gal<sub>f</sub>) and a pyruvate functionalized galactopyranose residue. Van den Bos *et al.* were the first to

40

describe the synthesis of a protected tetrasaccharide (Figure 2.3A).<sup>[20]</sup> The trisaccharide **55** was assembled using an efficient one-pot sequential glycosylation strategy in which first

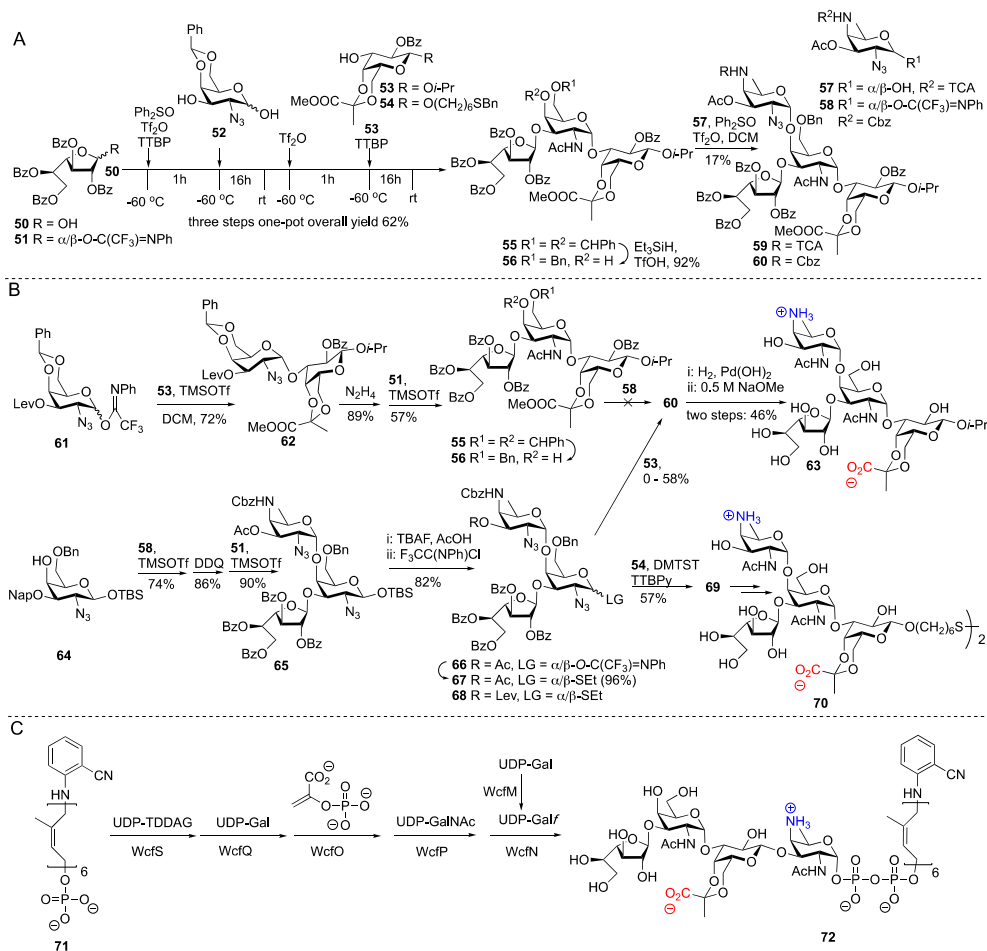

**Figure 2.3.** Syntheses toward the repeating unit of the ZPS PS A1. A) First assembly of a protected tetrasaccharide **59**. B) First completed synthesis of the PS A1 tetrasaccharide. C) Reconstitution of the biosynthesis of PS A1.

the Galf hemiacetal **50** was coupled to the diol **52** in a chemoselective dehydrative glycosylation following Gin's protocol. Next, triflic anhydride (Tf<sub>2</sub>O) was added to activate

the thus-generated disaccharide lactol. Ensuing addition of pyruvate galactose **53** led to the desired trisaccharide in 62% yield. After benzylidene opening the final condensation was attempted with the TDDAG donor **57**. Unfortunately, the desired tetrasaccharide **59** was formed in disappointing yield and not enough of the material was procured to deprotect the tetramer.

Pragani and Seeberger described a similar approach to generate the PS A1 tetrasaccharide and they also found that the condensation of a TDDAG donor (**58**) and the trisaccharide acceptor (**56**) was unproductive (Figure 2.3B).<sup>[21]</sup> According to molecular mechanics (MM2) energy minimized models of nucleophile **56**, the  $\alpha$ -pyruvylated galactose preferentially occupies the space below the galactosamine residue near the C6 benzyl ether. This steric crowding likely forces the C6 benzyl ether to the top face of the galactosamine residue, thereby shielding the already poorly nucleophilic C4-OH. Therefore, the synthesis route was adapted, changing the order of the glycosidic bond formations. The TDDAG (**58**) and GalN3 (**64**) building blocks could be coupled in 71% yield. Next the Nap ether was removed and the Galf attached (90%), eventually leading to the trisaccharide donor **66**. It proved challenging to couple this trimer in a stereoselective fashion to the pyruvate galactose acceptor. After screening several condensation conditions, it was found that the use of a thioglycoside donor (**67**) in combination with a mild activator (DMTST) performed best and tetramer **60** could be obtained in 58% yield. Deprotection of the tetrasaccharide **60** had to be done under carefully controlled conditions to prevent  $O \rightarrow N$  acyl migration. By transformation of the azides into acetamides, reduction of the benzyl ether and carbamate and ensuing saponification the final tetrasaccharide **63** was obtained in 46%. The NMR of this tetrasaccharide proved to

be remarkably similar to the NMR of the native polysaccharide, leading Pragani and Seeberger to conclude that the crowded nature of the tetrasaccharide repeating unit determines -to a large extent- the overall structure of the saccharide. This synthetic strategy also allowed for the assembly of spacer containing tetrasaccharide **69**. Deprotection of this molecule again required the Lev to BOM exchange as described above for the Sp1 saccharide. Ensuing azide to acetamide conversion and final dissolving metal reduction gave tetrasaccharide **70** as a disulfide. This molecule was reduced *in situ* and immobilized on a micro array slide and probed with rabbit sera raised against *Bacteroides fragilis*. Minimal interaction was detected using this experimental set-up (in contrast to the Sp1 micro array results described above).

Very recently, Troutman and co-workers reconstituted the biosynthesis pathway of the PS A1 repeating unit using heterologously expressed glycosyl and pyruvate transferases (Figure 2.3C).<sup>[22]</sup> They showed that in a one-pot operation the tetrasaccharide repeat could be built up on a fluorescently labelled bactoprenyl phosphate (BP). Through the consecutive action of the TDDAG-transferase WcfS (obtained in a membrane fraction) using UDP-TDDAG and the galactosyl transferase WcfQ (also in a membrane fraction) employing UDP-Gal as the donor substrate the BP linked TDDAG-Gal disaccharide was formed. This was shown to be the substrate for the pyruvate transferase, WcfO, which uses phosphoenol pyruvate (PEP) for pyruvate incorporation. Of note WcfO was incapable of transferring the pyruvate to simpler galactose substrates, such as UDP-Gal or nitrophenyl-Gal. The pyruvylated disaccharide serves as a substrate for the next transferase, WcfP, that introduces the GalNAc moiety. The non-pyruvylated BP-TDDAG-Gal is not elongated by this enzyme. Finally, WcfN transfers Galf from UDP-Galf, obtained from UDP-Gal through the

action of the galactopyranose mutase WcfM, to the BP-trisaccharide to complete the assembly of the PS A1 tetrasaccharide. It is expected that the polyprenylpyrophosphate tetrasaccharide can be used as a substrate to study the down-stream biosynthesis enzymes, including the polymerase that generates the polymeric PS A1 and the flippase that transposes the polysaccharide over the membrane to the outside of the bacterial cell wall. Generating larger oligomers or larger quantities of the fragments will represent a significant challenge as it will require harnessing the flippase and polymerase enzymes and demands the availability of sufficient donor glycosides or co-expression of the complete biomachinery to assemble these (the rare UDP-TDDAG donor is not readily available). Finally, controlling the length of the growing polymer will represent a significant challenge.

### 2.3 Conclusion

Synthetic organic chemistry is now at the level that short fragments of ZPSs are accessible, and the repeating units of the “archetype” ZPS, PS A1, and the Sp1 have been assembled by different laboratories. The longest ZPS to date, the Sp1 hexasaccharide encompassing two repeating units, has been synthesized by Bundle and co-workers. This molecule was evaluated for its T-cell stimulating activity, but shown to be inactive. The synthetic challenges encountered during the synthesis led Bundle and co-workers to conclude that “the resolution of the unresolved issue of the minimal size oligosaccharide for biological activity is unlikely to be addressed by oligosaccharide synthesis”. Although no syntheses have appeared yet to challenge this statement, there have been important advancements in synthetic oligosaccharide synthesis that set the stage for the construction of longer fragments. Effective routes of synthesis have been laid out to assemble the rare TDDAG building blocks<sup>[28-30]</sup> and our knowledge of reactive intermediates and their

stereoselectivity in glycosylation reactions has significantly deepened. New oxidation protocols have been introduced and ever more effective functional and protecting group chemistry is introduced. Finally, automated synthesis now allows for the generation of very large oligosaccharides in an automated manner.<sup>[31-33]</sup> It is therefore not unlikely that these complex and intriguing molecules will be man-made in the future. The availability of synthetic long fragments will allow the study of the interaction of these with MHC molecules in atomic detail to explain their mode of action in a definitive manner. Likewise, they can be used to unravel how these saccharides interact with players of the innate immune system and how this activity may be used to elicit a tailor made immune response.

## 2.4 References

- [1] A. Adibekian, P. Stallforth, M. L. Hecht, D. B. Werz, P. Gagneux and P. H. Seeberger, *Chem. Sci.*, **2011**, *2*, 337-344.
- [2] L. Sun, D. R. Middleton, P. L. Wantuch, A. Ozdilek, F. Y. Avci, *Glycobiology*, **2016**, *26*, 1029-1040.
- [3] F. Berti, R. Adamo, *ACS Chem. Biol.*, **2013**, *8*, 1653-1663
- [4] C. C. Daniels, P. D. Rogers, C. m. Shelton, *The Journal of Pediatric Pharmacology and Therapeutics*, **2016**, *21*, 27-35.
- [5] S. Nishat, P. R. Andreana, *Vaccines (Basel)*, **2016**, *4*, 19.
- [6] A. Tzianabos, A. Onderdonk, B. Rosner, R. Cisneros, D. L. Kasper, *Science*, **1993**, *262*, 416-419.
- [7] B. A. Cobb, Q. Wang, A. O. Tzianabos, D. L. Kasper, *Cell*, **2004**, *117*, 677-687.
- [8] A. Tzianabos, J. Y. Wang, D. L. Kasper, *Carbohydr. Res.*, **2003**, *338*, 2531-2538.
- [9] S. K. Mazmanian, D. L. Kasper, *Nat. Rev. Immunol.*, **2006**, *6*, 849-858.
- [10] Q. Wang, R. M. McLoughlin, B. A. Cobb, M. Charrel-Dennis, K. J. Zaleski, D. Golenbock, A. O. Tzianabos, D. L. Kasper, *J Exp Med*, **2006**, *203*, 2853-2863.
- [11] A. Wack, S. Gallorini, *Immunopharmacol Immunotoxicol*, **2008**, *30*, 761-770.
- [12] C. Jones, *Carbohydr. Res.*, **2005**, *340*, 1097-1106.
- [13] Y. Wang, W. M. Kalka-Moll, M. H. Roehrl, D. L. Kasper, *Proc Natl Acad Sci, USA*, **2000**, *97*, 13478-13483.
- [14] Y. H. Choi, M. H. Roehrl, D. L. Kasper, J. Y. Wang, *Biochemistry*, **2002**, *41*, 15144-15151.

## Chapter 2

---

- [15] L. S. Kreisman, J. H. Friedman, A. Neaga, B. A. Cobb, *Glycobiology*, **2007**, *17*, 46-55.
- [16] X. Wu, L. Cui, T. Lipinski, D. R. Bundle, *Chem. Eur. J.* **2010**, *16*, 3476-3488.
- [17] A. E. Christina, L. J. van den Bos, H. S. Overkleeft, G. A. van der Marel, J. D. C. Codée, *J. Org. Chem.*, **2011**, *76*, 1692-1706.
- [18] B. Schumann, R. Pragani, C. Anish, C. L. Pereira, P. H. Seeberger, *Chem. Sci.*, **2014**, *5*, 1992.
- [19] A. Ní Cheallaigh, S. Oscarson, *Can. J. Chem.*, **2016**, *94*, 940-960.
- [20] L. J. van den Bos, T. J. Boltje, T. Provoost, J. Mazurek, H. S. Overkleeft, G. A. van der Marel, *Tetrahedron Lett.*, **2007**, *48*, 2697-2700.
- [21] R. Pragani, P. H. Seeberger, *J. Am. Chem. Soc.*, **2011**, *133*, 102-107.
- [22] S. Sharma, K. M. Erickson, J. M. Troutman, *ACS Chemical Biology*, **2017**, *12*, 92-101.
- [23] E. Danieli, D. Proietti, G. Brogioni, M. R. Romano, E. Cappelletti, M. Tontini, F. Berti, L. Lay, P. Costantino, R. Adamo, *Bioorg. Med. Chem.*, **2012**, *20*, 6403-6415.
- [24] I. A. Gagarinov, T. Fang, L. Liu, A. D. Srivastava, G. J. Boons, *Org. Lett.*, **2015**, *17*, 928-931.
- [25] J. P. Yasomanee, S. Visansirikul, P. Pornsuriyasak, M. Thompson, S. A. Kolodziej, A. V. Demchenko, *J. Org. Chem.*, **2016**, *81*, 5981-5987.
- [26] S. Visansirikul, J. P. Yasomanee, P. Pornsuriyasak, M. N. Kamat, N. M. Podvalnyy, C. P. Gobble, M. Thompson, S. A. Kolodziej, A. V. Demchenko, *Org. Lett.*, **2015**, *17*, 2382-2384.
- [27] B. Hagen, S. Ali, H. S. Overkleeft, G. A. van der Marel, J. D. C. Codée, *J. Org. Chem.*, **2017**, *82*, 848-868.
- [28] A. E. Christina, V. M. Blas Ferrando, F. de Bordes, W. A. Spruit, H. S. Overkleeft, J. D. C. Codée, G. A. van der Marel, *Carbohydr. Res.*, **2012**, *356*, 282-287.
- [29] M. Emmadi, S. S. Kulkarni, *Nat. Protoc.*, **2013**, *8*, 1870-1889.
- [30] M. Emmadi, S. S. Kulkarni, *Nat. Prod. Rep.*, **2014**, *31*, 870-879.
- [31] O. J. Plante, E. R. Palmacci, P. H. Seeberger, *Science*, **2001**, *291*, 1523-1527.
- [32] M. T. C. Walvoort, A. G. Volbeda, N. R. Reintjens, H. van den Elst, O. J. Plante, H. S. Overkleeft, G. A. van der Marel, J. D. C. Codée, *Org. Lett.*, **2012**, *14*, 3776-3779.
- [33] O. Calin, S. Eller, P. H. Seeberger, *Angew. Chem., Int. Ed.*, **2012**, *52*, 5862-5865.



# 3

## On the Reactivity of Gulose and Guluronic Acid Building Blocks in the Context of Alginate Assembly

Partly published in: *Eur. J. Org. Chem*, **2016**, 2393-2397.

*Angew. Chem. Int. Ed*, **2015**, 54, 7670-7673.

### 3.1 Introduction

Gulose (Figure 3.1) is a rare monosaccharide that can be found in bacteria, archaea and algae. It can be considered to be the C-3 epimer of galactose or the C-5 epimer of mannose. L-guluronic acid and D-mannuronic acid are the two constituting monomers of alginate (see Figure 3.1), an important cell-wall polysaccharide of brown algae that is used in the pharmaceutical industry and food industry because of its gelating properties.<sup>[1]</sup>

Alginate also represents the exopolysaccharide of *Pseudomonas aeruginosa*, an opportunistic pathogen that is responsible for, amongst others, urinary tract, kidney, lung and burn wound infections.<sup>[2]</sup> *P. aeruginosa* uses alginate to create a protective biofilm, which makes it difficult to combat the bacterium by the host immune system and antibiotic therapies. Short alginate fragments can interact with the innate part of our immune system through interactions with Toll like receptors (TLRs)<sup>[3]</sup> and poly-mannuronic acid alginates have been used as a carbohydrate antigen in protein conjugate vaccine modalities to generate a potential *Pseudomonas aeruginosa* vaccine.<sup>[4]</sup> Well-defined synthetic fragments of the alginate polysaccharide are very valuable tools to unravel the mode of action of alginate at the molecular level.<sup>[5]</sup> Therefore several synthetic strategies to assemble different stretches of the alginate polymer have been developed,<sup>[6]</sup> and efficient routes towards the assembly of oligo-mannuronates,<sup>[7]</sup> and short oligo-guluronates<sup>[8]</sup> have been reported so far. The assembly of mixed sequence alginated has not been described so far.<sup>[9]</sup>

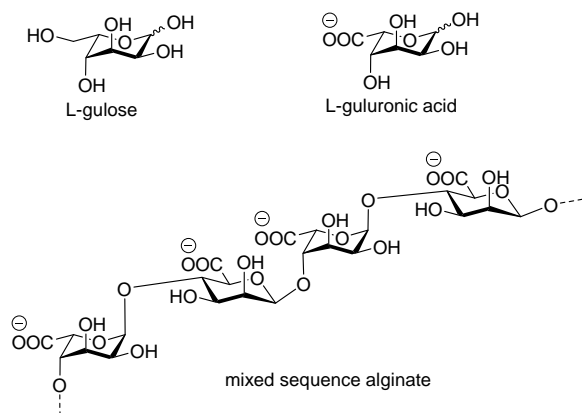

**Figure 3.1** Structure of L-gulose, L-guluronic acid and mixed sequence alginate.

During the assembly of guluronic acid containing alginate fragments, it has become apparent that gulosyl donor building blocks have the tendency to provide 1,2-*cis*-glycosidic linkages with unusual selectivity.<sup>[10]</sup> This behaviour has been rationalized by taking into account the reactivity of the intermediate oxocarbenium ion (-like) intermediates. An L-gulose oxocarbenium ion can adopt a <sup>4</sup>H<sub>3</sub>-half chair conformation, in which all substituents occupy an orientation considered favourable for the stability of the cation.<sup>[11]</sup> Attack on this ion by the incoming nucleophile occurs from the diastereotopic face that leads, *via* a chair-like transition state, to the 1,2-*cis*-product. Thus, the stereoselective introduction of the  $\alpha$ -gulosyl linkage can be effected with relative ease. The use of guluronic acid and gulose acceptor building blocks however, represents a challenge, as the gulosyl C-4-OH is a relatively poor nucleophile. To circumvent this problematic reactivity, Hung and co-workers have reported on the use of 1,6-anhydrogulose synthons, in which the steric and electronic surroundings of the alcohol are changed for the better.<sup>[6]</sup> Functional groups on a carbohydrate not only influence the reactivity of a carbohydrate donor building block but also the nucleophilicity of carbohydrate acceptors, and it is often surmised that uronic acid acceptors are relatively poor nucleophiles because of the electron withdrawing effect of the C-5-carboxylate.<sup>[12]</sup> To find an effective gulose / guluronic acid acceptor building block for the assembly of mixed alginate sequences and to shed light on the influence of the neighbouring C-5-functionality on the reactivity of the gulose acceptors this Chapter reports a study of a panel of gulose and guluronic acid acceptors in a variety of glycosylation reactions.

## 3.2 Results and Discussion

---

A set of glycosylation reactions was investigated using gulosyl acceptors, varying in the nature of their C-5 functionality and using coupling partners of varying size. Both monomeric and dimeric donors and acceptors were combined and both guluronic acid acceptors and gulose acceptors were examined. Also, the nature of the C-6-*O*-protecting group in the gulose acceptors was varied to see whether this has any influence on the efficiency of the condensation reactions.

The synthesis of the new gulosyl acceptors (**3-6**, **10-11**, **14-15**) and disaccharide donors (**16** and **18**) is shown in Scheme 3.1. Starting from silylidene protected  $\alpha$ -azidopropyl L-guloside **1**, the synthesis of which was reported previously by Dinkelaar *et al.*,<sup>[8]</sup> monomeric acceptors **3-6** were obtained. Thus, the silylidene functionality was removed to provide diol **2**, of which the primary alcohol was protected with an acetyl group (in **3**), as an allyl ether (in **4**) or masked with a cyanoethoxymethyl (CEM) group (in **5**). The latter group has not been employed in oligosaccharide synthesis before, but has found applications in RNA assembly and serves as a minimally intrusive base labile alcohol protecting group.<sup>[13]</sup> All these regioselective protections were achieved using Taylor's 2-aminoethyl diphenylborinic acid catalyst in conjunction with the appropriate electrophiles (acetyl chloride, allylbromide, cyanoethoxymethylchloride).<sup>[14]</sup> Guluronic ester acceptor **6** was obtained from **2** by a regioselective oxidation using the combination of tetramethylpiperidinyloxy free radical (TEMPO) and bisacetoxo iodobenzene (BAIB) and ensuing ester formation as described before.<sup>[9]</sup> The assembly of the disaccharide acceptors is also depicted in Scheme 3.1. A set of four disaccharide alcohols (**10-11** and **14-15**) was generated, having either a guluronic ester or a gulose acceptor at the non-reducing end end with either an anomeric  $\alpha$ -thiocresol (STol) or an  $\beta$ -azidopropyl group attached to the

Scheme 3.1 Synthesis of building blocks.

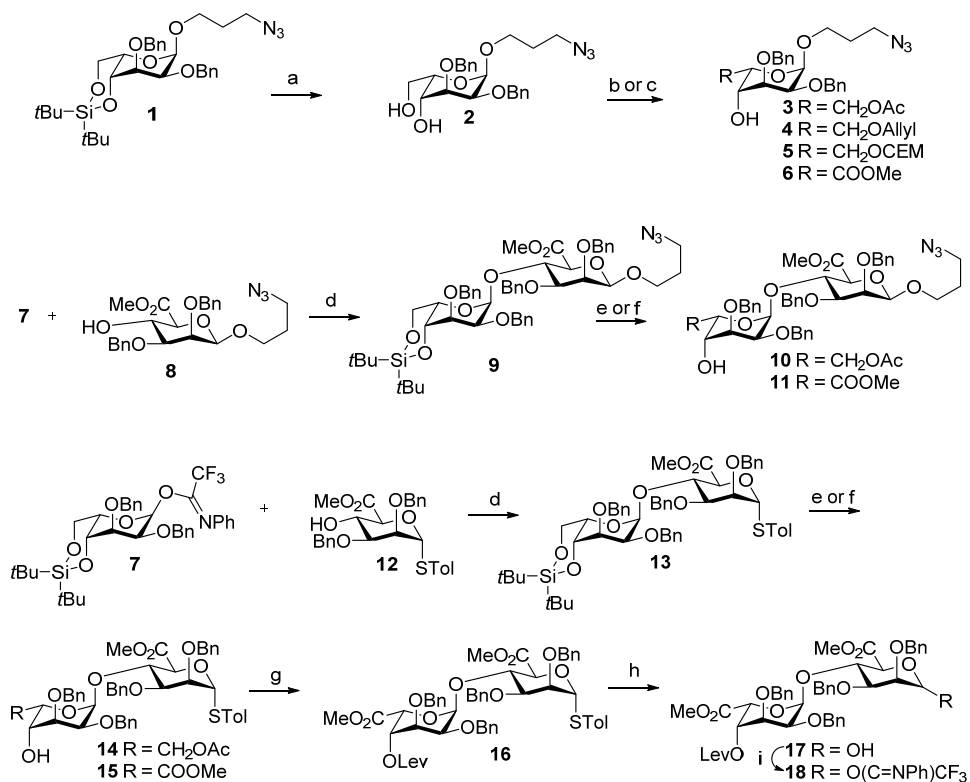

**Reagents and conditions:** (a) HF/Pyridine, Pyridine, THF, 0 °C to room temperature, yield: 81%. (b) 2-aminoethyl diphenylborinic acid, MeCN, AcCl for **3**: 90%; 2-aminoethyl diphenylborinic acid, MeCN, K<sub>2</sub>CO<sub>3</sub>, KI, AlBr for **4**: 83%; 2-aminoethyl diphenylborinic acid, MeCN, cyanoethoxymethylchloride for **5**: 97%. (c) i) TEMPO, BAIB, DCM/tBuOH/H<sub>2</sub>O (4/4/1,v/v/v); ii) MeI, K<sub>2</sub>CO<sub>3</sub>, DMF, 87%. (d) TMSOTf (cat.), CH<sub>2</sub>Cl<sub>2</sub>, -78 °C - -20 °C, **9**: 58%; **13**: 91%. (e) for **10** and **14**: i. HF.pyridine, pyridine, THF; ii. 2-aminoethyl diphenylborinic acid, MeCN, AcCl, **10**: 98%; **14**: 87%. (f) for **11** and **15**: i. HF.pyridine, pyridine, THF; ii. TEMPO, BAIB, tBuOH, THF, H<sub>2</sub>O, iii. MeI, K<sub>2</sub>CO<sub>3</sub>, DMF, **11**: 84% (3 steps); **15**: 83% (3 steps). (g) LevOH, EDCl, DMAP, CH<sub>2</sub>Cl<sub>2</sub>, 92%; (h) NIS, TFA, CH<sub>2</sub>Cl<sub>2</sub>, 91%; (i) F<sub>3</sub>CC(=NPh)Cl, K<sub>2</sub>CO<sub>3</sub>, acetone, 98%.

mannuronic acid side. The disaccharide acceptors were obtained from the fully protected gulose-mannuronic acid disaccharides **9** and **12**, which are synthesized from gulose donor

**7** and mannuronic acid acceptors **8** and **12**, respectively. Unmasking of the silylidene as described above and ensuing regioselective acetylation of the C-6-OH, again using Taylor's borinic acid catalyst and acetyl chloride, gave the gulose-mannuronic acid coupling partners **10** and **14**. Oxidation of the liberated primary alcohol functionalities and methyl ester formation gave the guluronic acid-mannuronic acid acceptors **11** and **15**. To generate donors **16-18**, the C-4-OH of disaccharide **15** was protected with a Lev group to form **16**. Hydrolysis of of the thioacetal using NIS/TFA produced lactol **17**, which was then transformed into imidate donor **18**.

With the set of donors (**16-19**)<sup>[7d]</sup> and acceptors (**3-6**, **10** and **11**) in hand the series of glycosylation reactions tabularized in Table 3.1 was performed. First, the mannuronic acid monosaccharide donor **19** was combined with the three differentially protected monomeric gulose acceptors **3-5** (Table 3.1, Entries 1-3). The three condensation reactions proceeded under TMSOTf catalysis and gave the disaccharides **22-24** with excellent stereoselectivity but in relatively poor yields. Where it could be reasoned that a more electron rich protecting group at C-6 would lead to a more nucleophilic C-4-OH, this was not apparent from the obtained results: the C-6-OAc gulose acceptor outperformed the acceptors protected with the allyl ether or cyanoethoxymethyl protecting groups (Table 3.1, Entries 1-3). In the next set of optimizations, it was found that the efficiency of the condensation of mannuronic acid donor **13** and the C-6-OAc gulose acceptor **3** could be improved by the use of TBSOTf, but not TfOH, in stead of TMSOTf under otherwise unchanged conditions (Table 3.1, Entries 4 and 5). When TBSOTf was used as a promotor in the condensation of guluronic acid acceptor **6** and donor **19**, disaccharide **25** was obtained in 55% yield (Table 3.1, entry 6). Notably the stereoselectivity of this coupling

reaction was significantly worse than the other glycosylations of mannuronic acid donor **19**, for which there currently is no adequate explanation.

Next, glycosylations of disaccharide imidate donor **18** were investigated. In the first instance, **18** was reacted with either C-6-OAc gulose acceptor **3** or guluronic ester acceptor **6**, under the agency of a catalytic amount of TBSOTf (Table 3.1, entry 7 and 8). Strikingly, these condensations proceeded with higher yields than the glycosylations of the monomeric donors and the guluronic acid acceptor gave the most productive glycosylation reaction (84% vs 69% for the C-6-OAc acceptor). Trisaccharide **27** was obtained as a single anomer, in contrast to the condensation of **6** with monosaccharide donor **19** (Table 3.1, entry 6). Next, the disaccharide acceptors **10**, **11**, **14** and **15** were probed. When the azidopropyl-functionalized dimers **10** and **11** were condensed with dimer donor **18**, tetrasaccharides **28** and **29** were obtained in low yields (33% and 26%, respectively, Table 3.1, entry 9 and 10). Increasing the amount of activator and prolonged reaction time gave **29** in 45% yield (Table 3.1, entry 11). The use of other donor types (**16** or **17**) and a pre-activation strategy to generate a higher concentration of the reactive intermediate anomeric triflate did not lead to a better outcome (Table 3.1, entries 12-14). Apparently, the larger size of the disaccharide nucleophiles (**10** vs **3** and **11** vs **6**) has a large impact on the reactivity of the gulosyl and guluronic acid C-4-OH.

Switching to the acceptor disaccharides with the anomeric  $\alpha$ -thiocresol moiety gave a significant increase in yield both for the C-6-OAc gulose acceptor **14** and the guluronic acid acceptor **15**. Tetrasaccharides **32** and **33** were obtained in 80% and 91% yield, respectively (Table 3.1, entry 15 and 16). When the two disaccharide acceptors **14** and **15** were condensed with monosaccharide donor **19** (Table 3.1, Entries 17 and 18) the two

trisaccharides **30** and **31** were also obtained in good yield and excellent stereoselectivity.

Remarkably, the large difference in yield for the glycosylations between disaccharide acceptors **10**, **11** and **14**, **15**, is caused by the difference in the anomeric functionality - a thiocresol (**14**, **15**) or azidopropanol group (**10**, **11**) - at the reducing end of the disaccharide acceptor, rather far removed from the reacting C4'-OH. To identify the underlying cause for the difference in reactivity of **10-11** and **14-15** a set of model couplings was performed. Thioether additives have previously been reported to modulate glycosylation reactions and anomeric sulfonium ions can serve as glycosylating species.<sup>[15]</sup> To probe whether the anomeric thio function was at the basis of the improved reactivity of acceptor **15** we added thiophene<sup>[15b]</sup> to the condensation of **18** and **11**, to find that this external sulphide had no notable effect on the reaction (Table 3.1, entry 19). Having established that the presence of a sulfur containing molecule in the mixture is not the main contributing factor at play, it was reasoned that the conformational flexibility of the acceptor could be the cause for the difference in reactivity between **10-11** and **14-15**. Where the  $\alpha$ -mannuronic acid moiety in **10-11** occupies a 'normal'  ${}^4C_1$  chair conformation, the  $\alpha$ -mannuronic acid in **14-15** takes up either a  ${}^4C_1$  or the 'inverted'  ${}^1C_4$  conformation, with a strong preference for the latter chair.<sup>[16]</sup>



## Reactivity of Gulose and Guluronic acid Building blocks

**Table 3.1** Glycosylation reactions using different gulosyl acceptors with mannuronic acid donors.

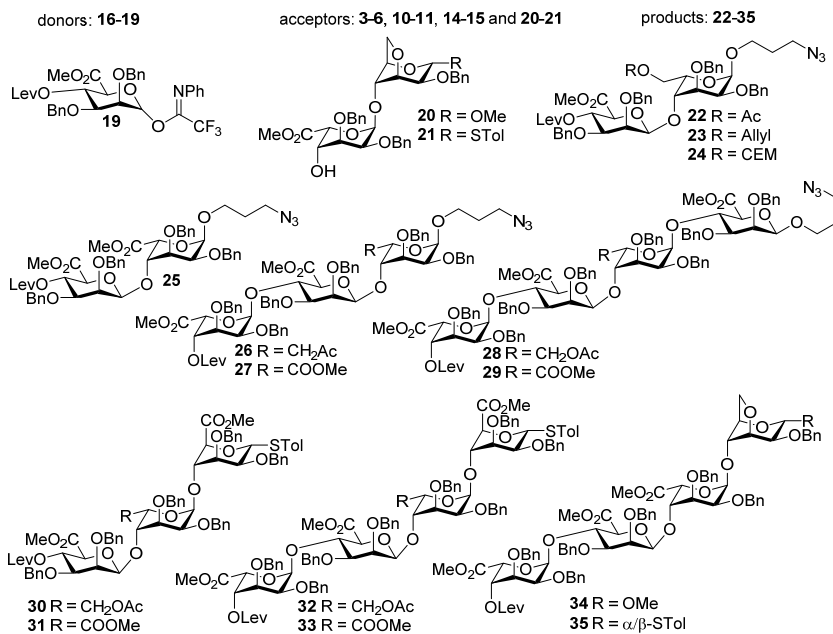

Entry	Donor	Acceptor	Conditions <sup>a</sup>	Product	Yield (α : β) <sup>b</sup>
1	19	3	TMSOTf	22	49% (0 : 1)
2	19	4	TMSOTf	23	23% (0 : 1)
3	19	5	TMSOTf	24	35% (0 : 1)
4	19	3	TfOH	22	30% (0 : 1)
5	19	3	TBSOTf	22	65% (0 : 1)
6	19	6	TBSOTf	25	55% (1 : 3)
7	18	3	TBSOTf	26	69% (0 : 1)
8	18	6	TBSOTf	27	84% (0 : 1)
9	18	10	TBSOTf	28	33% (0 : 1)
10	18	11	TBSOTf	29	26% (0 : 1)
11	18	11	TBSOTf	29	45% (0 : 1)
12	17	11	Ph <sub>2</sub> SO/TTBP/Tf <sub>2</sub> O	29	21% (0 : 1)
13	17	11	BSP/TTBP/Tf <sub>2</sub> O	29	32% (0 : 1)
14	16	11	BSP/TTBP/Tf <sub>2</sub> O	29	20% (0 : 1)
15	18	14	TBSOTf	32	80% (0 : 1)
16	18	15	TBSOTf	33	91% (0 : 1)
17	19	14	TBSOTf	30	77% (0 : 1)
18	19	15	TBSOTf	31	100% (0 : 1)
19	18	11	TBSOTf, thiophene	29	32% (0 : 1)
20	18	20	TBSOTf	34	95% (0 : 1)
21	18	21	TBSOTf	35	71% (0 : 1)

The conformational flexibility of **14** and **15** is reflected in their  $^1\text{H}$  NMR and  $^{13}\text{C}$  NMR spectra; the signals of the mannuronic acid ring appear as broad and poorly resolved resonances at room temperature. Figure 3.2 displays the  $^1\text{H}$  NMR spectra of acceptor **15** recorded at different temperatures. At low temperature ( $-60\text{ }^\circ\text{C}$ ), two resonance sets are apparent that coalesce with increasing temperature. The two resonance sets belong to the disaccharides with the mannuronic acid in a “normal”  $^4\text{C}_1$  chair conformation or taking up a  $^1\text{C}_4$  chair conformation. It becomes clear from the spectra that the  $^1\text{C}_4$  chair conformer is the most prevalent acceptor species present in the mixture. The ring flipping of the reducing end mannuronic acid to a  $^1\text{C}_4$  chair, changes the overall structure of the disaccharide and may make the C4' hydroxy group more accessible and, therefore, more reactive. To further test this hypothesis, two model acceptors were generated having a reducing end mannoside, locked in a  $^1\text{C}_4$  chair conformation: disaccharide **20** having an anomeric  $\alpha$ -O-methyl group and disaccharide **21** with an anomeric thiocresol moiety (Table 3.1, Entries 20 and 21). The acceptors could be condensed with donor **18** in good to excellent yield. In the latter condensation, the only notable side reaction that took place was the epimerisation of the anomeric thioacetal. From these experiments, it can be concluded that the overall three dimensional structure of the acceptor is of decisive influence and that the “open” shape of disaccharide **14** and **15** is at the basis of the apt nucleophilicity of the C-4'-OH.

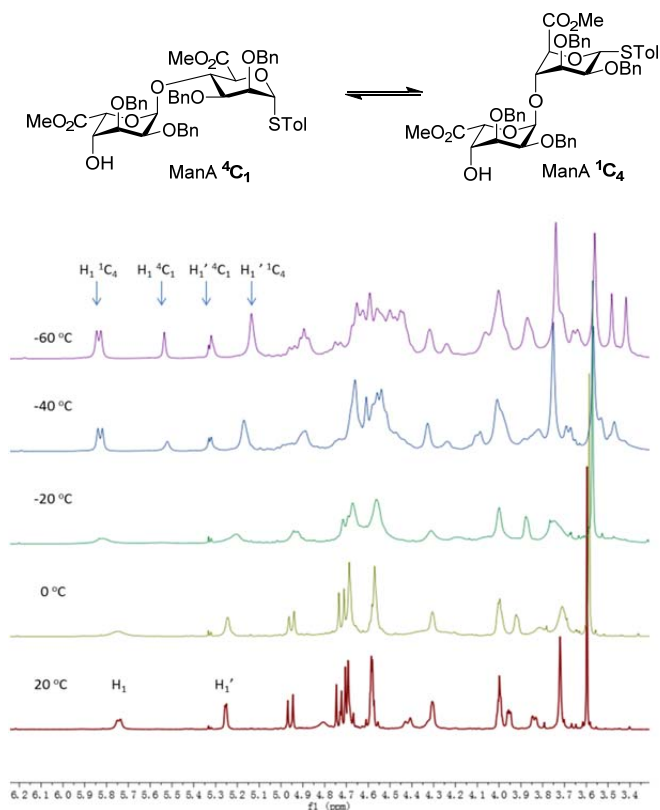

Figure 3.2 variable-temperature NMR spectra showing the converging resonance sets belonging to  ${}^4C_1$  and  ${}^1C_4$  mannuronic acid conformers.

### 3.3 Conclusions

In conclusion, a set of glycosylation reactions has been described to produce fully protected mixed sequence alginate oligomers up to the tetrasaccharide level. It was found that the gulosyl C-4 hydroxyl is a relatively poor nucleophile that can be hard to glycosylate. From the results presented in Table 3.1, it can be concluded that the functional group close to the acceptor alcohol group has little influence on its reactivity and at least in the set of glycosylations studied here no important disarming effect of the

C-5 carboxylate on the reactivity of the C-4-OH was found. In fact, C-5 carboxylic acid ester acceptors can outperform their non-oxidized counterparts (see Table 3.1, Entry 7 vs 8, 9 vs 10, 15 vs 16). An all-important factor, influencing the effectivity of the glycosylations, turned out to be the conformational flexibility of the acceptors at hand. Where the presence of a rigid  $\beta$ -mannuronic acid *O*-glycoside reducing end in the disaccharide acceptors led to poor glycosylation reactions the flexible  $\alpha$ -*S*-tolyl mannuronic acid reducing ends endowed the acceptors with excellent nucleophilicity. Further studies are required to provide detailed insight into how the conformational behaviour of mannuronic acid reducing ends influences the steric and electronic surroundings of the glucose-C-4'-alcohol. Conformational flexibility may prove to be important in many other glycosylations, since glycosylation reactions involving secondary alcohol acceptors generally proceed through a very crowded transition state.

### 3.4 Experimental Section

#### General experimental procedures

All reagents were of commercial grade and used as received. All moisture sensitive reactions were performed under an argon atmosphere. DCM used in the glycosylation was distilled over  $P_2O_5$  and stored on activated 5Å molecular sieves before being used. Reactions were monitored by TLC analysis with detection by UV (254 nm) and where applicable by spraying with 20% sulfuric acid in EtOH or with a solution of  $(NH_4)_6Mo_7O_{24} \cdot 4H_2O$  (25 g/L) and  $(NH_4)_4Ce(SO_4)_4 \cdot 2H_2O$  (10 g/L) in 10% sulfuric acid (aq.) followed by charring at  $\sim 150$  °C. Flash column chromatography was performed on silica gel (40-63 $\mu$ m).  $^1H$  and  $^{13}C$  spectra were recorded on a Bruker AV 400, in  $CDCl_3$ . Chemical shifts ( $\delta$ ) are given in ppm relative to tetramethylsilane as internal standard ( $^1H$  NMR in  $CDCl_3$ ) or the residual signal of the deuterated solvent. Coupling constants ( $J$ ) are given in Hz. All  $^{13}C$  spectra are proton decoupled. NMR peak assignments were made using COSY and HSQC experiments. Where applicable NOESY, HMBC and HMBCipvGATED experiments were used to further elucidate the structure. The anomeric product ratio's were analysed through integration of proton NMR signals.

## Reactivity of Gulose and Guluronic acid Building blocks

### General procedure for deprotecting of the di-*tert*-butyl silylidene ketal

A solution of HF/Pyridine solution (0.5 mmol, 5.0 eq) was added to a solution of starting material in a mixture of THF and pyridine (1/1, v/v, 2 ml) at 0 °C. The reaction was allowed to stir overnight at room temperature. Sat. aq. NaHCO<sub>3</sub> was added to neutralize the mixture, which was then diluted with EtOAc and washed with sat. aq. NaCl. The organic phase was dried over MgSO<sub>4</sub> and concentrated *in vacuo*. Purification by column chromatography yielded the deprotected product.

### General procedure for selective acetylation of the gulosyl C-6-OH

2-Aminoethyl diphenylborinate (20 mol %) and the diol substrate (1 mmol) were transferred to a 25-mL round-bottomed flask containing a magnetic stir bar. The flask was then sealed with a septum and purged with a balloon of argon. Anhydrous acetonitrile (5 mL) was added to the flask, followed by *N,N*-diisopropylethylamine (1.5 mmol) and acetyl chloride (1.3-1.5 mmol). The resulting mixture was stirred at room temperature for 4 hours. The mixture was then transferred to a separatory funnel containing water and ethyl acetate. The organic layer was separated, and the aqueous layer was extracted two more times with ethyl acetate. The combined organic layers were washed with brine, dried over MgSO<sub>4</sub>, filtered, and concentrated *in vacuo*. The resulting crude material was purified by silica gel chromatography.

### General Procedure for selective alkylation of the gulosyl C-6-OH

2-Aminoethyl diphenylborinate (20 mol %), the diol substrate (0.20 mmol), potassium iodide (0.20 mmol) and potassium carbonate (0.22 mmol) were transferred to a round-bottomed flask containing a magnetic stir bar. The vial was then sealed with a septum and purged with a balloon of argon. Anhydrous acetonitrile (1 mL) was added to the flask, followed by allyl bromide (0.30 mmol). The resulting mixture was stirred at 60 °C for 24 hours. The mixture was then transferred to a separatory funnel containing water and ethyl acetate. The organic layer was separated, and the aqueous layer was extracted two more times with ethyl acetate. The combined organic layers were washed with brine, dried over MgSO<sub>4</sub>, filtered, and concentrated *in vacuo*. The resulting crude material was purified by silica gel chromatography.

### General procedure for glycosylation reactions

Imidate donor (1.5-3.0 eq) and acceptor (1.0 eq) were co-evaporated with toluene (three times). The residue was dissolved in dry DCM (0.1 M acceptor in DCM). The solution was cooled to -78 °C, followed by the addition of TBSOTf or TMSOTf (0.2-0.6 eq) and the reaction was allowed to stir for 12h-48h at -78 °C to -20 °C. The reaction was quenched with Et<sub>3</sub>N and diluted with EtOAc, washed with sat. aq. NaCl. The organic phase was dried over Na<sub>2</sub>SO<sub>4</sub> and concentrated *in vacuo*. Purification by column chromatography yielded the product.

**3-Azidopropyl 2,3-*O*-benzyl- $\alpha$ -L-gulopyranoside (2):** This product was prepared following the general procedure for deprotecting of the di-*tert*-butyl silylidene ketal. 590 mg (1.33 mmol), yield: 81%. 1H

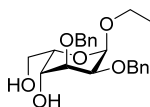

## Chapter 3

NMR (CDCl<sub>3</sub>, 400 MHz, HH-COSY, HSQC):  $\delta$  7.32-7.24 (m, 10H, CH<sub>arom</sub>), 4.94-4.79 (m, 2H, H-1, CHH Bn), 4.71-4.44 (m, 3H, CHH Bn), 4.07 (dd,  $J = 3.7, 1.3$  Hz, 1H, H-4), 3.99 (dd,  $J = 3.8, 1.3$  Hz, 1H, H-5), 3.93-3.73 (m, 5H, H-2, H-3, H-6, -OCH<sub>2</sub>CH<sub>2</sub>CH<sub>2</sub>N<sub>3</sub>), 3.45 (dt,  $J = 9.8, 5.5$  Hz, 1H, -OCH<sub>2</sub>CH<sub>2</sub>CH<sub>2</sub>N<sub>3</sub>), 3.37 (t,  $J = 6.6$  Hz, 2H, OCH<sub>2</sub>CH<sub>2</sub>CH<sub>2</sub>N<sub>3</sub>), 1.99-1.71 (m, 2H, -OCH<sub>2</sub>CH<sub>2</sub>CH<sub>2</sub>N<sub>3</sub>); <sup>13</sup>C-APT NMR (CDCl<sub>3</sub>, 100 MHz, HSQC):  $\delta$  138.9, 138.2(C<sub>q</sub>), 128.5, 128.3, 127.9, 127.7, 127.7, 127.6(CH<sub>arom</sub>), 98.0(C-1), 75.6(C-3), 73.4(C-2), 73.2 (CH<sub>2</sub> Bn), 71.6(CH<sub>2</sub> Bn), 71.3(C-5), 65.6(C-4), 64.8(-OCH<sub>2</sub>CH<sub>2</sub>CH<sub>2</sub>N<sub>3</sub>), 64.4(C-6), 48.4(-OCH<sub>2</sub>CH<sub>2</sub>CH<sub>2</sub>N<sub>3</sub>), 29.0(-OCH<sub>2</sub>CH<sub>2</sub>CH<sub>2</sub>N<sub>3</sub>).

**3-Azidopropyl 6-O-acetyl-2,3-O-benzyl- $\alpha$ -L-gulopyranoside (3):** This product was prepared following the general

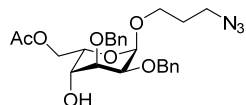

procedure for selective acetylation of the gulosyl C-6-OH. Yield: 346 mg (0.71 mmol), 90%. TLC:  $R_f = 0.69$  (pentane:ethyl acetate = 1:1). <sup>1</sup>H NMR (CDCl<sub>3</sub>, 400 MHz, HH-COSY, HSQC):  $\delta$  7.45 – 7.16 (m, 10H, CH<sub>arom</sub>), 4.69 – 4.52 (m, 5H, CH<sub>2</sub> Bn, H-1), 4.37 – 4.06 (m, 3H, H-5, H-6), 3.92 – 3.69 (m, 4H, H-3, H-2, H-4, -OCH<sub>2</sub>CH<sub>2</sub>CH<sub>2</sub>N<sub>3</sub>), 3.50-3.36 (m, 3H, -OCH<sub>2</sub>CH<sub>2</sub>CH<sub>2</sub>N<sub>3</sub>), 2.60 (bs, 1H, 4-OH), 2.05 (s, 3H, CH<sub>3</sub>CO), 2.01 – 1.72 (m, 2H, -OCH<sub>2</sub>CH<sub>2</sub>CH<sub>2</sub>N<sub>3</sub>); <sup>13</sup>C –APT NMR (CDCl<sub>3</sub>, 100 MHz, HSQC):  $\delta$  171.2(C=O Ac), 138.8, 138.1(C<sub>q</sub> arom), 128.5, 128.3, 127.9, 127.7, 127.7, 127.6(CH<sub>arom</sub>), 97.6(C-1), 75.9(C-3), 73.2(C-2), 73.2, 71.7(CH<sub>2</sub>Bn), 68.7(C-4), 64.9(C-5), 64.9(-OCH<sub>2</sub>CH<sub>2</sub>CH<sub>2</sub>N<sub>3</sub>), 63.5(C-6), 48.4(-OCH<sub>2</sub>CH<sub>2</sub>CH<sub>2</sub>N<sub>3</sub>), 29.0(CH<sub>3</sub>CO), 20.9(-OCH<sub>2</sub>CH<sub>2</sub>CH<sub>2</sub>N<sub>3</sub>). [ $\alpha$ ]<sub>D</sub><sup>20</sup> = -113° (c = 1.0, CHCl<sub>3</sub>). IR (neat): 606, 652, 696, 734, 817, 908, 955, 1026, 1069, 1115, 1140, 1234, 1302, 1369, 1454, 1717, 1738, 2093, 2875, 2924. HR-MS: [M+Na<sup>+</sup>] Calculated for C<sub>25</sub>H<sub>31</sub>N<sub>3</sub>O<sub>7</sub>: 508.20542; found: 508.20518.

**3-Azidopropyl 6-O-allyl-2,3-O-benzyl- $\alpha$ -L-gulopyranoside (4):** This product was prepared following the general

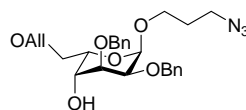

procedure for selective alkylation of the gulosyl C-6-OH. Yield: 160 mg, (0.33 mmol), 83%. TLC:  $R_f = 0.64$  (pentane:ethyl acetate = 2:1). <sup>1</sup>H NMR (CDCl<sub>3</sub>, 400 MHz, HH-COSY, HSQC):  $\delta$  7.44 – 7.14 (m, 10H, CH<sub>arom</sub>), 5.87 (m, 1H, CH All), 5.32 – 5.10 (m, 2H, CH<sub>2</sub> All), 4.95 – 4.81 (m, 2H, CHH Bn, H-1), 4.71 – 4.49 (m, 3H, CH<sub>2</sub> Bn), 4.23 – 4.11 (m, 1H, H-5), 4.10 – 3.61 (m, 8H, CH<sub>2</sub> All, H-4, H-2, H-3, H-6, -OCH<sub>2</sub>CH<sub>2</sub>CH<sub>2</sub>N<sub>3</sub>), 3.46 (dt,  $J = 9.9, 5.5$  Hz, 1H, -OCH<sub>2</sub>CH<sub>2</sub>CH<sub>2</sub>N<sub>3</sub>), 3.36 (t,  $J = 6.7$  Hz, 2H, -OCH<sub>2</sub>CH<sub>2</sub>CH<sub>2</sub>N<sub>3</sub>), 2.00 – 1.76 (m, 2H, -OCH<sub>2</sub>CH<sub>2</sub>CH<sub>2</sub>N<sub>3</sub>); <sup>13</sup>C –APT NMR (CDCl<sub>3</sub>, 100 MHz, HSQC):  $\delta$  139.1, 138.3(C<sub>q</sub> arom), 133.8(CH All), 128.4, 128.2, 127.8, 127.7, 127.6, 127.5(CH<sub>arom</sub>), 118.0(CH<sub>2</sub>=CH All), 98.2(C-1), 75.5(C-3), 73.4(C-2), 73.1(CH<sub>2</sub>Bn), 72.8(CH<sub>2</sub> All), 72.0(C-6), 71.5(CH<sub>2</sub>Bn), 71.2(C-4), 64.8(C-5), 64.7(-OCH<sub>2</sub>CH<sub>2</sub>CH<sub>2</sub>N<sub>3</sub>), 48.4(-OCH<sub>2</sub>CH<sub>2</sub>CH<sub>2</sub>N<sub>3</sub>), 29.0(-OCH<sub>2</sub>CH<sub>2</sub>CH<sub>2</sub>N<sub>3</sub>). [ $\alpha$ ]<sub>D</sub><sup>20</sup> = -45° (c = 1.0, CHCl<sub>3</sub>). IR (neat): 633, 696, 731, 822, 910, 1026, 1067, 1088, 1207, 1265, 1306, 1339, 1456, 2095, 2870, 2920. HR-MS: [M+Na<sup>+</sup>] Calculated for C<sub>26</sub>H<sub>33</sub>N<sub>3</sub>O<sub>6</sub>: 506.22616; found: 506.22587.

**3-Azidopropyl 6-O-cyanoethoxymethyl-2,3-O-benzyl- $\alpha$ -L-gulopyranoside (5):** This product was prepared following

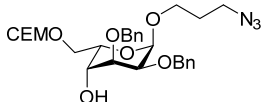

the general procedure for selective acetylation of the gulosyl C-6-OH. Yield: 206 mg, (0.39 mmol), 97%. TLC:  $R_f = 0.39$  (pentane:ethyl acetate = 1:1). <sup>1</sup>H NMR

## Reactivity of Gulose and Guluronic acid Building blocks

(CDCl<sub>3</sub>, 400 MHz, HH-COSY, HSQC):  $\delta$  7.40 – 7.20 (m, 10H, CH<sub>arom</sub>), 4.97 – 4.83 (m, 2H, CHH Bn, H-1), 4.73 (d,  $J$  = 1.3 Hz, 2H, CH<sub>2</sub>OCH<sub>2</sub>CH<sub>2</sub>CN), 4.70 – 4.51 (m, 3H, CH<sub>2</sub>Bn), 4.25 (t,  $J$  = 4.1, 1H, H-5), 3.97 (bs, 1H, H-3), 3.93 – 3.79 (m, 5H, H-2, H-4, H-6, -OCH<sub>2</sub>CH<sub>2</sub>CH<sub>2</sub>N<sub>3</sub>), 3.79 – 3.70 (m, 2H, CH<sub>2</sub>OCH<sub>2</sub>CH<sub>2</sub>CN), 3.48 (dt,  $J$  = 9.8, 5.5 Hz, 1H, OCH<sub>2</sub>CH<sub>2</sub>CH<sub>2</sub>N<sub>3</sub>), 3.39 (t,  $J$  = 6.7 Hz, 2H, OCH<sub>2</sub>CH<sub>2</sub>CH<sub>2</sub>N<sub>3</sub>), 2.97 (s, 1H, 4-OH), 2.61 (t,  $J$  = 6.2 Hz, 2H, CH<sub>2</sub>OCH<sub>2</sub>CH<sub>2</sub>CN), 2.06 – 1.76 (m, 2H, OCH<sub>2</sub>CH<sub>2</sub>CH<sub>2</sub>N<sub>3</sub>); <sup>13</sup>C –APT NMR (CDCl<sub>3</sub>, 100 MHz, HSQC):  $\delta$  138.9, 138.2(C<sub>q</sub>arom), 128.4, 128.2, 127.8, 127.7, 127.5 CH<sub>arom</sub>, 117.8 (CH<sub>2</sub>OCH<sub>2</sub>CH<sub>2</sub>CN), 98.0(C-1), 95.7(CH<sub>2</sub>OCH<sub>2</sub>CH<sub>2</sub>CN), 75.5(C-2), 73.2(C-4), 73.1, 71.5(CH<sub>2</sub>Bn), 70.5(C-3), 69.1(C-6), 64.9(OCH<sub>2</sub>CH<sub>2</sub>CH<sub>2</sub>N<sub>3</sub>), 64.8(C-5), 62.8(CH<sub>2</sub>OCH<sub>2</sub>CH<sub>2</sub>CN), 48.3(OCH<sub>2</sub>CH<sub>2</sub>CH<sub>2</sub>N<sub>3</sub>), 29.0(CH<sub>2</sub>OCH<sub>2</sub>CH<sub>2</sub>CN), 19.0(OCH<sub>2</sub>CH<sub>2</sub>CH<sub>2</sub>N<sub>3</sub>).  $[\alpha]^{20}_D = -43^\circ$  ( $c = 0.42$ , CHCl<sub>3</sub>). IR (neat): 698, 735, 820, 910, 1028, 1080, 1117, 1165, 1263, 1456, 1263, 1454, 1735, 2095, 2853, 2924. HR-MS: [M+Na]<sup>+</sup> Calculated for C<sub>27</sub>H<sub>34</sub>N<sub>4</sub>O<sub>7</sub>: 549.23197; found: 549.23166.

### Synthesis of gulose donor (7)

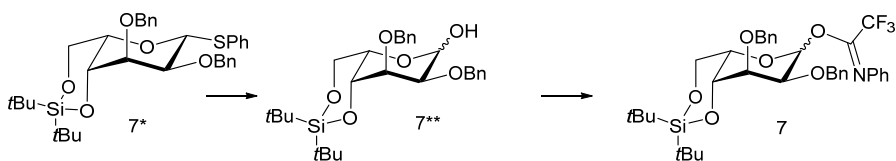

### 2,3-Di-*O*-benzyl-4,6-*O*-di-*tert*-butylsilylidene- $\alpha/\beta$ -L-gulopyranoside (7\*\*)

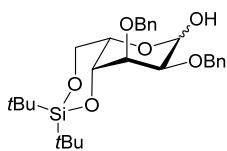

NIS (1.12 g, 5.0 mmol) and TFA (385  $\mu$ l, 5.0 mmol) were added to a solution of **7\*** (2.95 g, 5.0 mmol) in CH<sub>2</sub>Cl<sub>2</sub> (40 ml) at 0 °C. After analysis by TLC showed complete consumption of the starting material, the reaction was quenched with Et<sub>3</sub>N. Saturated Na<sub>2</sub>S<sub>2</sub>O<sub>3</sub> (aq) was added to the reaction mixture, which was then stirred for 30 min. The aqueous layer was extracted twice with CH<sub>2</sub>Cl<sub>2</sub>, and concentrated *in vacuo*. Purification by column chromatography yielded **7\*\*** as a colourless oil (2.2 g, 88%). Spectroscopic data were in accord with those reported previously.<sup>[8]</sup>

### 2,3-Di-*O*-benzyl-4,6-*O*-di-*tert*-butylsilylidene-1-*O*-(*N*-phenyl-trifluoroacetimidoyl)- $\alpha,\beta$ -L-gulopyranoside (7)

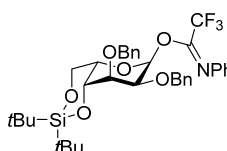

Compound **3\*\*** (4.16 g, 8.3 mmol) was dissolved in acetone (75 ml) and the solution was cooled to 0 °C. *N*-phenyl-trifluoroacetimidoyl chloride (2.27 g, 10.9 mmol) and cesium carbonate (4.06 g, 12.5 mmol) were added and the resulting suspension was stirred overnight at room temperature. Then Et<sub>3</sub>N was added to the reaction mixture, after which it was filtered and the filtrate was concentrated *in vacuo*. Purification by column

## Chapter 3

chromatography (silica gel, pentane/EtOAc/Et<sub>3</sub>N, 20/1/trace, v/v/trace) yielded **3** as a slightly yellow solid (5.57 g, quantitative). Analytical data are reported for the major isomer ( $\alpha$ ). TLC:  $R_f$  = 0.86 (pentane/EtOAc, 10/1, v/v); <sup>1</sup>H NMR (CDCl<sub>3</sub>, 400 MHz, 50°C, HH-COSY, HSQC):  $\delta$  7.48 – 7.15 (m, 12H, CH<sub>arom</sub>), 7.14 – 6.96 (m, 1H, CH<sub>arom</sub>), 6.92 – 6.76 (m, 2H, CH<sub>arom</sub>), 5.94 (s, 1H, H-1), 4.85 (d,  $J$  = 11.8 Hz, 1H, CHH Bn), 4.77 (d,  $J$  = 12.0 Hz, 1H, CHH Bn), 4.65 (d,  $J$  = 12.0 Hz, 1H, CHH Bn), 4.57 (d,  $J$  = 12.0 Hz, 1H, CHH Bn), 4.21 – 4.00 (m, 3H, H-4, H-6), 3.95 – 3.80 (m, 2H, H-3, H-2), 3.61 (bs, 1H, H-5), 1.00 (s, 18H, 6XCH<sub>3</sub>); <sup>13</sup>C–APT NMR (CDCl<sub>3</sub>, 100 MHz, HSQC):  $\delta$  144.0, 138.4, 138.0(C<sub>q</sub>arom), 128.5, 128.4, 128.3, 128.1, 127.8, 127.7, 127.7(C<sub>q</sub>arom), 124.0, 119.6(CH NPh), 96.1(C-1), 77.9(C-2), 74.6(C-3), 73.9, 73.2(CH<sub>2</sub>Bn), 71.8(C-4), 70.9(C-5), 66.7(C-6), 27.6, 27.3(CH<sub>3</sub> *tert*-Bu), 23.2(C<sub>q</sub> *tert*-Bu), 20.5(C<sub>q</sub> *tert*-Bu). HR-MS: [M+Na<sup>+</sup>] Calculated for C<sub>36</sub>H<sub>44</sub>F<sub>3</sub>NO<sub>6</sub>Si: 694.27822; found: 694.27827.

### Synthesis of dissacharide 12

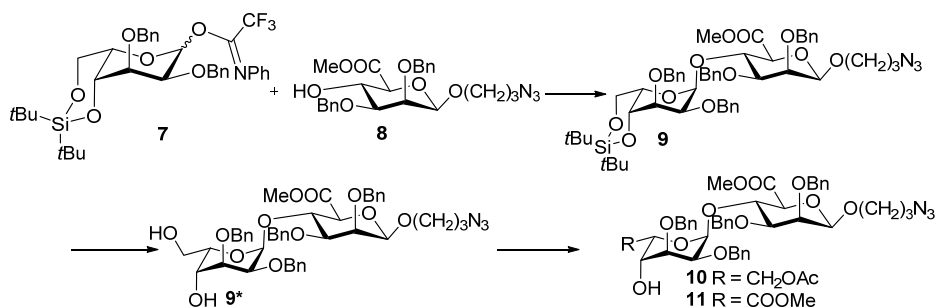

### Methyl (3-Azidopropyl 2,3-di-O-benzyl-4-O-[2,3-di-O-benzyl-4,6-di-tert-Butylsilylidene- $\alpha$ -L-gulopyranosyl]- $\alpha$ -D-

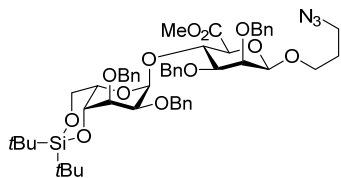

mannopyranosyl uronate) (**9**): Imidate donor **7** (492 mg, 0.733 mmol) and acceptor **8**<sup>[7a]</sup> (230 mg, 0.488 mmol) were co-evaporated with toluene (three times). The residue was dissolved in dry DCM (5 ml). The solution was cooled to -78 °C and TBSOTf (23  $\mu$ l, 0.1 mmol) was added, after which the reaction was allowed to stir for 2 days during

which is was gradually warmed from -78°C to -20°C. The reaction was quenched with Et<sub>3</sub>N and diluted with EtOAc, washed with sat. aq. NaCl and the organic phase was dried over Na<sub>2</sub>SO<sub>4</sub> and concentrated *in vacuo*. Purification by column chromatography (silica gel, pentane/EtOAc, 4/1, v/v) yielded **11** as a colourless syrup (270 mg, 58%). TLC:  $R_f$  = 0.14 (pentane/ EtOAc, 6/1, v/v); <sup>1</sup>H NMR (CDCl<sub>3</sub>, 400 MHz, HH-COSY, HSQC):  $\delta$  7.49 – 7.05 (m, 20H, CH<sub>arom</sub>), 5.12 – 5.00 (m, 1H, H-1<sub>Gul</sub>), 4.97 (d,  $J$  = 11.8 Hz, 1H, CH<sub>2</sub>Bn), 4.83 (d,  $J$  = 12.3 Hz, 1H, CH<sub>2</sub>Bn), 4.73 – 4.48 (m, 6H, CH<sub>2</sub>Bn, H-1<sub>Mann</sub>, H-4<sub>Mann</sub>), 4.45 (d,  $J$  = 10.9 Hz, 1H, CH<sub>2</sub>Bn), 4.27 (d,  $J$  = 10.9 Hz, 1H, CH<sub>2</sub>Bn), 4.13 – 4.01 (m, 3H, H-6<sub>Gul</sub>, H-4<sub>Gul</sub>, H-5<sub>Gul</sub>), 3.98 (dd,  $J$  = 3.6, 1.2 Hz, 1H, H-3<sub>Gul</sub>), 3.90 (dd,  $J$  = 2.8, 1.3 Hz, 1H, H-3<sub>Mann</sub>), 3.79 – 3.71 (m, 3H, H-2<sub>Gul</sub>, H-5<sub>Mann</sub>, -OCH<sub>2</sub>CH<sub>2</sub>CH<sub>2</sub>N<sub>3</sub>), 3.59 (s, 3H), 3.57 – 3.43 (m, 2H, H-6<sub>Gul</sub>, H-2<sub>Mann</sub>), 3.43 – 3.26 (m, 3H, OCH<sub>2</sub>CH<sub>2</sub>CH<sub>2</sub>N<sub>3</sub>), 2.02 – 1.76 (m, 2H, OCH<sub>2</sub>CH<sub>2</sub>CH<sub>2</sub>N<sub>3</sub>), 0.92 (s, 9H, 3XCH<sub>3</sub> *tert*-Bu), 0.84 (s, 9H, 3XCH<sub>3</sub> *tert*-Bu); <sup>13</sup>C–



## Reactivity of Gulose and Gulosonic acid Building blocks

APT NMR (CDCl<sub>3</sub>, 100 MHz, HSQC):  $\delta$  169.1(-COOCH<sub>3</sub>), 139.3, 138.7, 138.1, 137.9(C<sub>q</sub> arom), 128.4, 128.2, 128.2, 128.1, 128.0, 127.7, 127.7, 127.5, 127.5, 127.4(CH<sub>arom</sub>), 101.5(C-1<sub>Mann</sub>), 96.9(C-1<sub>Gul</sub>), 79.9(C-2<sub>Mann</sub>), 75.8(C-2<sub>Gul</sub>, C-4<sub>Gul</sub>), 73.8(C-3<sub>Mann</sub>), 73.8(CH<sub>2</sub>Bn), 73.1(CH<sub>2</sub>Bn), 72.9(C-5<sub>Mann</sub>), 72.6(C-3<sub>Gul</sub>), 72.4(C-4<sub>Mann</sub>), 71.8, 71.1(CH<sub>2</sub>Bn), 66.7(OCH<sub>2</sub>CH<sub>2</sub>CH<sub>2</sub>N<sub>3</sub>, C-6<sub>Gul</sub>), 64.0(C-5<sub>Gul</sub>), 52.2(-COOCH<sub>3</sub>), 48.4(OCH<sub>2</sub>CH<sub>2</sub>CH<sub>2</sub>N<sub>3</sub>), 29.1(OCH<sub>2</sub>CH<sub>2</sub>CH<sub>2</sub>N<sub>3</sub>), 27.6, 27.2(CH<sub>3</sub> *tert*-Bu), 23.2, 20.3(C<sub>q</sub> *tert*-Bu).  $[\alpha]^{20}_D = -65^\circ$  (c = 0.24, CHCl<sub>3</sub>). IR (neat): 650, 698, 737, 826, 860, 1084, 1138, 1362, 1456, 1558, 1684, 1749, 2857, 2932. HR-MS: [M+Na<sup>+</sup>] Calculated for C<sub>52</sub>H<sub>67</sub>O<sub>12</sub>SiN<sub>3</sub>: 976.43862; found: 976.43980.

### Methyl (3-Azidopropyl 2,3-di-O-benzyl-4-O-[2,3-di-O-benzyl-4,6-di-hydroxyl- $\alpha$ -L-gulopyranosyl]- $\alpha$ -D-mannopyranosyl uronate) (9\*):

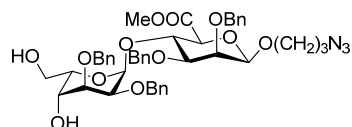

A HF/Pyridine solution (146  $\mu$ l) was added to a solution of compound **11** (300 mg, 0.315 mmol) in a mixture of THF (2 ml) and pyridine (2 ml) at 0  $^\circ$ C. The reaction was allowed to stir overnight at room temperature. Then, a sat. aq. NaHCO<sub>3</sub> was added to neutralize

the mixture, which was diluted with EtOAc, washed with sat. aq. NaCl. The organic phase was dried over Na<sub>2</sub>SO<sub>4</sub> and concentrated *in vacuo*. Purification by column chromatography (silica gel, pentane/EtOAc, 1/1, v/v) yielded **9\*** as a colourless oil (220 mg, 86%). TLC: R<sub>f</sub> = 0.36 (pentane/ EtOAc, 6/1, v/v); <sup>1</sup>H NMR (CDCl<sub>3</sub>, 400 MHz, HH-COSY, HSQC):  $\delta$  7.46 – 7.00 (m, 20H, CH<sub>arom</sub>), 5.08 (d, *J* = 4.0 Hz, 1H, H-1<sub>Gul</sub>), 4.88 (dd, *J* = 12.2, 8.5 Hz, 2H, CH<sub>2</sub>Bn), 4.70 (d, *J* = 12.4 Hz, 1H, CH<sub>2</sub>Bn), 4.66 – 4.45 (m, 5H, H-1<sub>Mann</sub>, H-4<sub>Mann</sub>, CH<sub>2</sub>Bn), 4.41 (d, *J* = 11.0 Hz, 1H, CH<sub>2</sub>Bn), 4.25 (d, *J* = 11.0 Hz, 2H, H-5<sub>Gul</sub>, CH<sub>2</sub>Bn), 4.13 – 3.97 (m, 2H, H-5<sub>Mann</sub>, -OCH<sub>2</sub>CH<sub>2</sub>CH<sub>2</sub>N<sub>3</sub>), 3.90 (d, *J* = 3.1 Hz, 1H, H-3<sub>Mann</sub>), 3.80 (dt, *J* = 7.8, 3.3 Hz, 3H, H-2<sub>Gul</sub>, H-4<sub>Gul</sub>, H-3<sub>Gul</sub>), 3.59 (s, 3H, CH<sub>3</sub> COOCH<sub>3</sub>), 3.58 – 3.40 (m, 3H, -OCH<sub>2</sub>CH<sub>2</sub>CH<sub>2</sub>N<sub>3</sub>, H-6<sub>Gul</sub>, H-2<sub>Mann</sub>), 3.37 (t, *J* = 6.6 Hz, 2H, -OCH<sub>2</sub>CH<sub>2</sub>CH<sub>2</sub>N<sub>3</sub>), 3.23 (dd, *J* = 12.0, 3.8 Hz, 1H, H-6<sub>Gul</sub>), 1.88 (m, 2H, -OCH<sub>2</sub>CH<sub>2</sub>CH<sub>2</sub>N<sub>3</sub>). <sup>13</sup>C-APT NMR (CDCl<sub>3</sub>, 100 MHz, HSQC):  $\delta$  169.1(-COO-), 139.1, 138.7, 137.6(C<sub>q</sub> arom), 128.4, 128.3, 128.3, 128.2, 128.0, 127.8, 127.6, 127.6, 127.5(CH<sub>arom</sub>), 101.7(C-1<sub>Mann</sub>), 96.8(C-1<sub>Gul</sub>), 79.9(C-2<sub>Mann</sub>), 75.8(C-5<sub>Mann</sub>), 75.3(C-3<sub>Gul</sub>), 74.1(C-3<sub>Mann</sub>), 74.1(CH<sub>2</sub>Bn), 73.5(C-2<sub>Gul</sub>), 73.0(CH<sub>2</sub>Bn), 72.3 C-4<sub>Mann</sub>), 72.0, 71.4(CH<sub>2</sub>Bn), 71.3(C-4<sub>Gul</sub>), 66.8(OCH<sub>2</sub>CH<sub>2</sub>CH<sub>2</sub>N<sub>3</sub>), 65.5(C-5<sub>Gul</sub>), 64.0(C-6<sub>Gul</sub>), 52.4(-COOCH<sub>3</sub>), 48.4(OCH<sub>2</sub>CH<sub>2</sub>CH<sub>2</sub>N<sub>3</sub>), 29.2(OCH<sub>2</sub>CH<sub>2</sub>CH<sub>2</sub>N<sub>3</sub>).  $[\alpha]^{20}_D = -83^\circ$  (c = 0.3, CHCl<sub>3</sub>). HR-MS: [M+Na<sup>+</sup>] Calculated for C<sub>44</sub>H<sub>51</sub>O<sub>12</sub>N<sub>3</sub>: 836.33650; found: 836.33755.

### Methyl (3-Azidopropyl 2,3-di-O-benzyl-4-O-[6-O-acetyl-2,3-di-O-benzyl-4-di-hydroxyl- $\alpha$ -L-gulopyranosyl]- $\alpha$ -D-mannopyranosyl uronate) (10):

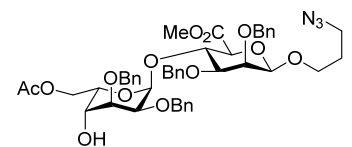

This product was prepared following the general procedure for selective acetylation of the gulosyl C-6-OH. TLC: R<sub>f</sub> = 0.50 (pentane:ethyl acetate = 7:5). Yield: 68 mg, (0.08 mmol), 79%. <sup>1</sup>H NMR (CDCl<sub>3</sub>, 400 MHz, HH-COSY, HSQC):  $\delta$  7.45 – 7.05 (m, 20H, CH<sub>arom</sub>), 5.08 (d, *J* = 4.0 Hz, 1H, H-1<sub>Gul</sub>), 4.86 (dd, *J* = 18.4, 12.2 Hz, 2H, CH<sub>2</sub>Bn), 4.74 – 4.34 (m, 8H, H-1<sub>Mann</sub>, H-4<sub>Mann</sub>, CH<sub>2</sub>Bn), 4.20 – 3.97 (m, 3H, H-6<sub>Gul</sub>, H-5<sub>Mann</sub>, -OCH<sub>2</sub>CH<sub>2</sub>CH<sub>2</sub>N<sub>3</sub>), 3.94 – 3.72 (m, 4H, H-3<sub>Mann</sub>, H-3<sub>Gul</sub>, H-2<sub>Gul</sub>, H-6<sub>Gul</sub>), 3.68 – 3.43 (m, 5H, H-4<sub>Gul</sub>, CH<sub>3</sub> COOCH<sub>3</sub>, H-2<sub>Mann</sub>, -OCH<sub>2</sub>CH<sub>2</sub>CH<sub>2</sub>N<sub>3</sub>), 3.36 (t, *J* = 6.8 Hz, 2H, -OCH<sub>2</sub>CH<sub>2</sub>CH<sub>2</sub>N<sub>3</sub>),

## Chapter 3

2.58 (t,  $J = 4.1$  Hz, 1H,  $G_4$ -OH), 1.94 (s, 3H,  $CH_3$  Ac), 1.92 – 1.77 (m, 2H,  $-OCH_2CH_2CH_2N_3$ );  $^{13}C$ -APT NMR ( $CDCl_3$ , 100 MHz, HSQC):  $\delta$  171.1, 169.2(-COO-), 139.0, 138.1( $C_{q\text{arom}}$ ), 128.5, 128.3, 128.3, 128.2, 128.2, 128.1, 127.9, 127.8, 127.7, 127.7, 127.6, 127.6, 127.5( $CH_{\text{arom}}$ ), 101.4(C-1 $_{Mann}$ ), 96.7(C-1 $_{Gul}$ ), 79.4(C-2 $_{Mann}$ ), 75.6(C-5 $_{Mann}$ ), 75.5(C-3 $_{Mann}$ ), 74.3(C-3 $_{Gul}$ ), 73.9( $CH_2$ Bn), 73.4(C-2 $_{Gul}$ ), 73.2( $CH_2$ Bn), 73.0(C-4 $_{Mann}$ ), 72.1, 71.6( $CH_2$ Bn), 69.2(C-4 $_{Gul}$ ), 66.8( $OCH_2CH_2CH_2N_3$ ), 64.6(C-5 $_{Gul}$ ), 63.6(C-6 $_{Gul}$ ), 52.4(-COOCH $_3$ ), 48.4( $OCH_2CH_2CH_2N_3$ ), 29.2( $OCH_2CH_2CH_2N_3$ ), 20.9( $CH_3$  Ac);  $^{13}C$ -HMBC ( $CDCl_3$ , 100 MHz): 101.4( $J_{C1,H1} = 157$ Hz, C-1 $_{Mann}$ ), 96.7( $J_{C1,H1} = 168$ Hz, C-1 $_{Gul}$ ).  $[\alpha]^{20}_D = -81^\circ$  (c = 0.28,  $CHCl_3$ ). HR-MS:  $[M+NH_4]^+$  Calculated for  $C_{46}H_{53}N_3O_{13}$ : 873.39166; found: 873.39255.

### Methyl (3-Azidopropyl 2,3-di-O-benzyl-4-O-[methyl 2,3-di-O-benzyl-4-hydroxyl- $\alpha$ -L-gulopyranosyl uronate]- $\beta$ -D-

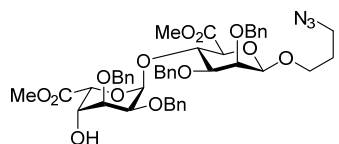

mannopyranosyl uronate) (**11**): Compound **9\*** (260 mg, 0.319 mmol) was

dissolved in DCM/*tert*-BuOH/ $H_2O$  (4.5 ml, 4/4/1, v/v/v). The mixture was cooled to  $0^\circ C$  and treated with TEMPO (10 mg, 0.064 mmol) and BAIB (267 mg, 0.829 mmol). After stirring overnight at  $4^\circ C$ ,  $Na_2S_2O_3$  was added, the mixture was diluted with EtOAc, washed with sat. aq. NaCl and the organic phase was dried over  $Na_2SO_4$  and concentrated *in vacuo*. The crude residue was dissolved in DMF (3 ml), followed by addition of  $K_2CO_3$  (45 mg, 0.326 mmol) and MeI (60  $\mu$ l) at  $0^\circ C$ . The mixture was allowed to stir overnight at  $4^\circ C$ , and then diluted with EtOAc, washed with sat. aq. NaCl. The organic phase was dried over  $Na_2SO_4$  and concentrated *in vacuo*. Purification by column chromatography (silica gel, pentane/DCM/EtOAc, 2/1/1, v/v/v) yielded **12** as a colourless oil (234 mg, 87%). TLC:  $R_f = 0.53$  (pentane/DCM/EtOAc, 1/1/1, v/v/v);  $^1H$  NMR ( $CDCl_3$ , 400 MHz, HH-COSY, HSQC):  $\delta$  7.47 – 7.07 (m, 20H,  $CH_{\text{arom}}$ ), 5.24 (d,  $J = 3.9$  Hz, 1H, H-1 $_{Gul}$ ), 5.05 (d,  $J = 2.0$  Hz, 1H, H-5 $_{Gul}$ ), 4.82 (dd,  $J = 25.5, 12.1$  Hz, 2H,  $CH_2$ Bn), 4.67 – 4.35 (m, 8H, H-1 $_{Mann}$ , H-4 $_{Mann}$ ,  $CH_2$ Bn), 4.15 – 3.98 (m, 3H, H-4 $_{Gul}$ , H-5 $_{Mann}$ ,  $-OCH_2CH_2CH_2N_3$ ), 3.91 – 3.70 (m, 3H, H-3 $_{Mann}$ , H-3 $_{Gul}$ , H-2 $_{Gul}$ ), 3.68 – 3.40 (m, 7H, 2x $CH_3$  COOCH $_3$ , H-2 $_{Mann}$ ), 3.35 (t,  $J = 6.9$  Hz, 2H,  $-OCH_2CH_2CH_2N_3$ ), 1.98 – 1.68 (m, 2H,  $-OCH_2CH_2CH_2N_3$ );  $^{13}C$ -APT NMR ( $CDCl_3$ , 100 MHz, HSQC):  $\delta$  170.6, 168.9(-COO-), 138.9, 138.1( $C_{q\text{arom}}$ ), 128.5, 128.4, 128.4, 128.3, 128.3, 128.2, 128.2, 128.0, 127.9, 127.9, 127.8, 127.7, 127.7, 127.6, 127.5, 127.4( $CH_{\text{arom}}$ ), 101.5(C-1 $_{Mann}$ ), 97.3(C-1 $_{Gul}$ ), 79.3(C-2 $_{Mann}$ ), 75.7(C-5 $_{Mann}$ ), 75.3(C-3 $_{Gul}$ ), 74.0(C-3 $_{Mann}$ ), 73.9(C-4 $_{Gul}$ ), 73.1( $CH_2$ Bn), 73.1(C-2 $_{Gul}$ ), 73.0, 71.8, 71.6( $CH_2$ Bn), 70.0(C-4 $_{Gul}$ ), 68.3(C-5 $_{Gul}$ ), 66.8( $OCH_2CH_2CH_2N_3$ ), 52.4(-COOCH $_3$ ), 52.2(-COOCH $_3$ ), 48.5( $OCH_2CH_2CH_2N_3$ ), 29.2( $OCH_2CH_2CH_2N_3$ );  $^{13}C$ -HMBCipvGATED ( $CDCl_3$ , 100 MHz): 101.5( $J_{C1,H1} = 156$ Hz, C-1 $_{Mann}$ ), 97.3( $J_{C1,H1} = 170$ Hz, C-1 $_{Gul}$ ).  $[\alpha]^{20}_D = -80^\circ$  (c = 1,  $CHCl_3$ ). HR-MS:  $[M+Na]^+$  Calculated for  $C_{45}H_{51}O_{13}N_3$ : 864.33141; found: 864.33247.

## Synthesis of disaccharide acceptor 14-15 and disaccharide donors 16-18

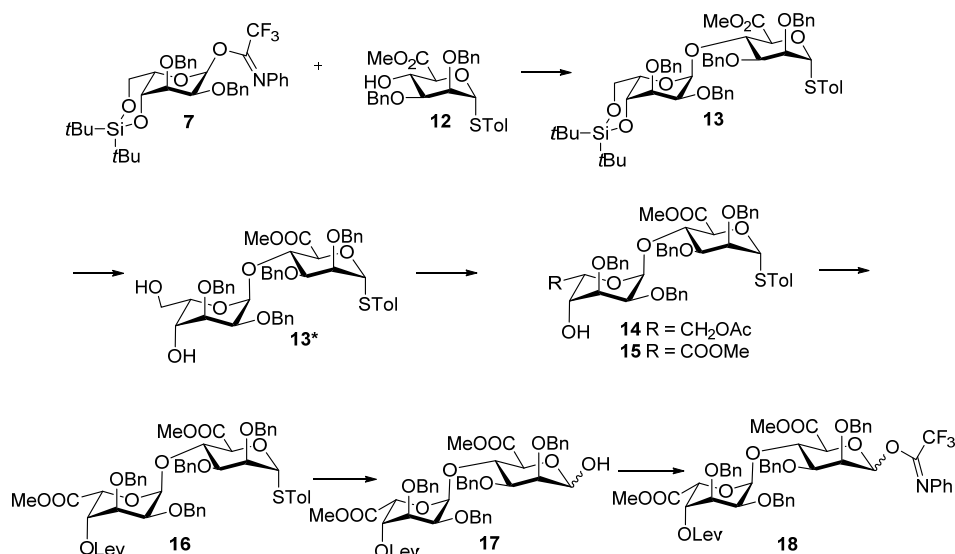

**Methyl (*p*-methoxyphenyl 2,3-di-*O*-benzyl-4-*O*-[2,3-di-*O*-benzyl-4,6-di-*tert*-butyl-silylidene- $\alpha$ -L-gulopyranosyl]-1-thio- $\alpha$ -D-mannopyranosyl uronate) (**13**):**

Imidate donor **7** (2.24 g, 3.34 mmol) and acceptor **12** (1.1 g, 2.23 mmol) were co-evaporated with toluene (three times). The residue was dissolved in dry DCM (22 mL). The solution was cooled to -78 °C and TBSOTf (102  $\mu$ l, 0.45 mmol) was added, after which the reaction was allowed to stir overnight and slowly warm to -20 °C. The reaction was quenched with Et<sub>3</sub>N and diluted with EtOAc, washed with sat. aq. NaCl. The organic phase was dried over Na<sub>2</sub>SO<sub>4</sub> and concentrated *in vacuo*. Purification by column chromatography (silica gel, pentane/EtOAc, 15/1, v/v) yielded **5** as a colourless oil (2.02 g, 93%). TLC: R<sub>f</sub> = 0.43 (pentane/EtOAc, 10/1, v/v); <sup>1</sup>H NMR (CDCl<sub>3</sub>, 400 MHz, HH-COSY, HSQC):  $\delta$  7.53 (d, *J* = 8.2 Hz, 2H, CH<sub>arom</sub>), 7.48 – 7.10 (m, 20H, CH<sub>arom</sub>), 7.05 (d, *J* = 8.2 Hz, 2H, CH<sub>arom</sub>), 5.70 (d, *J* = 7.9 Hz, 1H, H-1<sub>Mann</sub>), 5.04 – 4.91 (m, 2H, H-1<sub>Gul</sub>, CHH Bn), 4.69 – 4.52 (m, 4H, H-5<sub>Mann</sub>, CH<sub>2</sub>Bn), 4.52 – 4.32 (m, 4H, H-4<sub>Mann</sub>, CH<sub>2</sub>Bn), 4.23 – 4.06 (m, 2H, H-3<sub>Gul</sub>, CHH Bn), 3.97 – 3.65 (m, 7H, H-2<sub>Gul</sub>, H-4<sub>Gul</sub>, H-6<sub>Gul</sub>, H-2<sub>Mann</sub>, H-5<sub>Gul</sub>, H-3<sub>Mann</sub>), 3.55 (s, 3H, CH<sub>3</sub>O), 2.26 (s, 3H, CH<sub>3</sub>CO), 1.00 (s, 9H, 3xCH<sub>3</sub> *tert*-Bu), 0.93 (s, 9H, 3xCH<sub>3</sub> *tert*-Bu). <sup>13</sup>C-APT NMR (CDCl<sub>3</sub>, 100 MHz, HSQC):  $\delta$  169.8(-COOCH<sub>3</sub>), 139.3, 138.3, 137.8, 136.9(C<sub>q</sub> arom), 131.7, 129.6(CH<sub>arom</sub>), 129.4(C<sub>q</sub> arom), 128.5, 128.4, 128.3, 128.2, 128.0, 127.9, 127.8, 127.8, 127.7, 127.5(CH<sub>arom</sub>), 97.6(C-1<sub>Gul</sub>), 83.3 (C-1<sub>Mann</sub>, the chemical shift of this carbon is determined from the HSQC spectrum because it is not apparent in the APT spectrum), 75.8(C-3<sub>Mann</sub>, C-2<sub>Gul</sub>), 75.0(C-2<sub>Mann</sub>), 74.2(C-4<sub>Mann</sub>), 73.3(C-4<sub>Gul</sub>), 73.0(C-3<sub>Gul</sub>), 73.3, 72.6, 72.4, 71.5(CH<sub>2</sub>Bn), 66.9(C-6<sub>Gul</sub>), 64.7(C-5<sub>Gul</sub>), 52.0(-COOCH<sub>3</sub>), 27.6, 27.3(CH<sub>3</sub> *tert*-Bu), 23.3, (C<sub>q</sub> *tert*-Bu), 21.1(CH<sub>3</sub>CO), 20.5(C<sub>q</sub> *tert*-Bu). [ $\alpha$ ]<sub>D</sub><sup>20</sup> = -25° (c = 0.44, CHCl<sub>3</sub>). IR (neat): 698, 737, 799, 1016, 1086, 1117, 1140,

## Chapter 3

1749, 2859, 2891, 2932. HR-MS:  $[M+H]^+$  Calculated for  $C_{56}H_{68}O_{11}SSi$ : 977.43244; found: 977.43354.

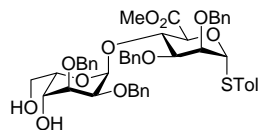
**Methyl (*p*-methylphenyl 2,3-di-*O*-benzyl-4-*O*-[2,3-di-*O*-benzyl-4,6-di-hydroxyl- $\alpha$ -L-gulopyranosyl]-1-thio- $\alpha$ -D-mannopyranosyl uronate) (**13\***):** A HF/Pyridine solution (675  $\mu$ l) was added to a solution of compound **13** (0.9 g,



0.92 mmol) in a mixture of THF (5 ml) and pyridine (5 ml) at 0 °C. The reaction was allowed to stir overnight at room temperature. Then sat. aq. NaHCO<sub>3</sub> was added to neutralize the mixture, which was subsequently diluted with EtOAc, washed with sat. aq. NaCl. The organic phase was dried over Na<sub>2</sub>SO<sub>4</sub> and concentrated *in vacuo*. Purification by column chromatography (silica gel, pentane/EtOAc, 2/1, v/v) yielded **13\*** as a colourless oil (0.65 g, 85%). TLC:  $R_f$  = 0.52 (pentane/EtOAc, 1/1, v/v). <sup>1</sup>H NMR (CDCl<sub>3</sub>, 400 MHz, HH-COSY, HSQC):  $\delta$  7.64 – 6.88 (m, 24H, CH<sub>arom</sub>), 5.66 (d,  $J$  = 7.2 Hz, 1H, H-1<sub>Mann</sub>), 5.09 (d,  $J$  = 4.0 Hz, 1H, H-1<sub>Gul</sub>), 4.86 (d,  $J$  = 11.7 Hz, 1H, CH<sub>2</sub>Bn), 4.73 – 4.34 (m, 8H, H-5<sub>Mann</sub>, H-4<sub>Mann</sub>, CH<sub>2</sub>Bn), 4.31 – 4.12 (m, 1H, CH<sub>2</sub>Bn), 4.06 – 3.67 (m, 6H, H-5<sub>Gul</sub>, H-4<sub>Gul</sub>, H-2<sub>Gul</sub>, H-3<sub>Gul</sub>, H-2<sub>Mann</sub>, H-3<sub>Mann</sub>), 3.51 (bs, 5H, H-6<sub>Gul</sub>, CH<sub>3</sub> COOCH<sub>3</sub>), 2.24 (s, 3H, CH<sub>3</sub> STol); <sup>13</sup>C-APT NMR (CDCl<sub>3</sub>, 100 MHz, HSQC):  $\delta$  169.9(-COO-), 139.0(C<sub>q</sub>arom), 138.3, 138.0, 137.6, 137.1(C<sub>q</sub>arom), 131.8(CH<sub>arom</sub>), 130.3(C<sub>q</sub>arom), 129.6, 128.4, 128.4, 128.3, 128.2, 128.1, 128.0, 127.9, 127.9, 127.8, 127.7, 127.7, 127.7, 127.6, 127.6, 127.5, 127.5, 127.4(CH<sub>arom</sub>), 97.0(C-1<sub>Gul</sub>), 85.7(C-1<sub>Mann</sub>, the chemical shift of this carbon is determined from the HSQC spectrum because it is not apparent in the APT spectrum), 75.6(C-3<sub>Mann</sub>), 75.0(C-3<sub>Gul</sub>, C-2<sub>Mann</sub>), 73.8(C-2<sub>Gul</sub>, C-4<sub>Mann</sub>), 73.6(C-5<sub>Mann</sub>), 73.0, 72.4, 71.6(CH<sub>2</sub>Bn), 71.5(C-4<sub>Gul</sub>), 66.3(C-5<sub>Gul</sub>), 63.8(C-6<sub>Gul</sub>), 52.1(-COOCH<sub>3</sub>), 21.1(CH<sub>3</sub>CO).  $[\alpha]_D^{20}$  = -40° (c = 0.88, CHCl<sub>3</sub>). IR (neat): 696, 733, 808, 891, 910, 947, 1018, 1026, 1072, 1105, 1207, 1242, 1281, 1362, 1395, 1454, 1495, 1734, 1749, 2857, 2922, 3450. HR-MS:  $[M+Na]^+$  Calculated for  $C_{48}H_{52}O_{11}S$ : 859.31225; found: 859.31366.

**Methyl (*p*-methylphenyl 2,3-di-*O*-benzyl-4-*O*-[6-*O*-acetyl-2,3-di-*O*-benzyl-4-hydroxyl- $\alpha$ -L-gulopyranosyl]-1-thio- $\alpha$ -D-mannopyranosyl uronate) (**14**):** This product was prepared following the general procedure for selective acetylation of the gulosyl C-6-OH. Yield: 153

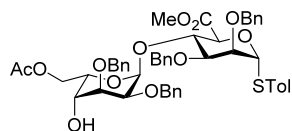

mg, (0.17 mmol), 87%. TLC:  $R_f$  = 0.26 (pentane:ethyl acetate = 2:1). <sup>1</sup>H NMR (CDCl<sub>3</sub>, 400 MHz, HH-COSY, HSQC):  $\delta$  7.66 – 6.87 (m, 20H, CH<sub>arom</sub>), 5.71 (d,  $J$  = 8.5 Hz, 1H, H-1<sub>Mann</sub>), 5.15 – 4.97 (m, 1H, H-1<sub>Gul</sub>), 4.86 (d,  $J$  = 11.8 Hz, 1H, CH<sub>2</sub>Bn), 4.71 – 4.35 (m, 8H, H-5<sub>Mann</sub>, H-4<sub>Mann</sub>, CH<sub>2</sub>Bn), 4.31 – 4.03 (m, 3H, H-5<sub>Gul</sub>, CH<sub>2</sub>Bn, H-6<sub>Gul</sub>), 3.98 (dd,  $J$  = 11.4, 6.6 Hz, 1H, H-6<sub>Gul</sub>), 3.92 – 3.72 (m, 5H, H-3<sub>Gul</sub>, H-2<sub>Gul</sub>, H-4<sub>Gul</sub>, H-3<sub>Mann</sub>, H-2<sub>Mann</sub>), 3.51 (s, 3H, CH<sub>3</sub> COOCH<sub>3</sub>), 2.67 (d,  $J$  = 5.4 Hz, 1H, G<sub>4</sub>-OH), 2.25 (s, 3H, CH<sub>3</sub> STol), 1.98 (s, 3H, CH<sub>3</sub>CO); <sup>13</sup>C-APT NMR (CDCl<sub>3</sub>, 100 MHz, HSQC):  $\delta$  171.1, 169.7(-COO-), 138.9, 138.1, 137.8(C<sub>q</sub>arom), 131.6(CH<sub>arom</sub>), 130.5(C<sub>q</sub>arom), 129.6, 128.5, 128.5, 128.4, 128.3, 128.3, 128.1, 128.0, 128.0, 127.9, 127.8, 127.8, 127.7, 127.6, 127.6(CH<sub>arom</sub>), 96.7(C-1<sub>Gul</sub>), 82.8(C-1<sub>Mann</sub>), 75.7(C-3<sub>Gul</sub>, C-3<sub>Mann</sub>), 75.1(C-2<sub>Mann</sub>), 74.0(C-4<sub>Mann</sub>), 73.7(C-5<sub>Mann</sub>), 73.7(C-2<sub>Gul</sub>), 73.2, 72.7, 72.6, 71.8(CH<sub>2</sub>Bn), 69.4(C-4<sub>Gul</sub>), 65.6(C-5<sub>Gul</sub>), 63.4(C-6<sub>Gul</sub>), 52.1(-COOCH<sub>3</sub>), 29.8(CH<sub>3</sub>CO), 21.1(CH<sub>3</sub> STol).  $[\alpha]_D^{20}$  = -27° (c = 0.94, CHCl<sub>3</sub>). HR-MS:  $[M+Na]^+$  Calculated for  $C_{50}H_{54}O_{12}S$ : 901.32282; found: 901.32365.

## Reactivity of Gulose and Gluronic acid Building blocks

**Methyl (*p*-methylphenyl 2,3-di-*O*-benzyl-4-*O*-[methyl 2,3-di-*O*-benzyl-4-hydroxyl- $\alpha$ -L-gulopyranosyl uronate]-1-thio- $\alpha$ -D-mannopyranosyl uronate) (15):** Compound **13\*** (1.86 g, 2.61 mmol) was dissolved in DCM/*tert*-BuOH/H<sub>2</sub>O (22.5

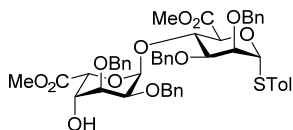

ml, 4/4/1, v/v/v) and the mixture was cooled to 0 °C and treated with TEMPO (72 mg, 0.46 mmol) and BAIB (1.92 g, 5.96 mmol). After stirring overnight at 4 °C, Na<sub>2</sub>S<sub>2</sub>O<sub>3</sub> was added, the mixture diluted with EtOAc, washed with sat. aq. NaCl and the organic phase was dried over Na<sub>2</sub>SO<sub>4</sub> and concentrated *in vacuo*. The crude residue was dissolved in DMF (15 ml), followed by the addition of K<sub>2</sub>CO<sub>3</sub> (580 mg, 4.2 mmol) and MeI (250  $\mu$ l) at 0 °C. The mixture was allowed to stir overnight at 4 °C, after which it was diluted with EtOAc, washed with sat. aq. NaCl. The organic phase was dried over Na<sub>2</sub>SO<sub>4</sub> and concentrated *in vacuo*. Purification by column chromatography (silica gel, pentane/EtOAc, 2/1, v/v) yielded **6** as a colourless oil (1.9 g, two steps: 98%).

TLC: R<sub>f</sub> = 0.50 (pentane/EtOAc, 1/1, v/v); <sup>1</sup>H NMR (CDCl<sub>3</sub>, 400 MHz, HH-COSY, HSQC):  $\delta$  7.52 (d, *J* = 8.1 Hz, 2H, CH<sub>arom</sub>), 7.47 – 7.11 (m, 20H, CH<sub>arom</sub>), 7.04 (d, *J* = 8.2 Hz, 2H, CH<sub>arom</sub>), 5.69 (d, *J* = 8.0 Hz, 1H, H-1<sub>Mann</sub>), 5.15 (d, *J* = 3.8 Hz, 1H, H-1<sub>Gul</sub>), 4.85 (d, *J* = 11.8 Hz, 1H, CH<sub>2</sub>Bn), 4.71 – 4.30 (m, 7H, H-5<sub>Gul</sub>, CH<sub>2</sub>Bn, H-5<sub>Mann</sub>, H-4<sub>Mann</sub>), 4.19 (m, 2H, H-4<sub>Gul</sub>, CH<sub>2</sub>Bn), 3.91 – 3.59 (m, 7H, H-3<sub>Gul</sub>, H-2<sub>Gul</sub>, H-3<sub>Mann</sub>, H-2<sub>Mann</sub>, CH<sub>3</sub> COOCH<sub>3</sub>), 3.51 (s, 3H, CH<sub>3</sub> COOCH<sub>3</sub>), 2.46 (d, *J* = 6.1 Hz, 1H, C-4<sub>Gul</sub>-OH), 2.26 (s, 3H, CH<sub>3</sub> STol); <sup>13</sup>C-APT NMR (CDCl<sub>3</sub>, 100 MHz, HSQC):  $\delta$  170.4, 169.6(-COO-), 138.7, 138.2(C<sub>q</sub> arom), 131.9(CH<sub>arom</sub>), 130.2(C<sub>q</sub> arom), 129.6, 128.6, 128.5, 128.3, 128.0, 127.9, 127.8(CH<sub>arom</sub>), 97.8(C-1<sub>Gul</sub>), 82.8(C-1<sub>Mann</sub>, the chemical shift of this carbon is according to HSQC because it can not seen from carbon spectrum), 75.4(C-3<sub>Mann</sub>), 75.2(C-3<sub>Gul</sub>), 74.8(C-4<sub>Mann</sub>, C-2<sub>Mann</sub>), 74.0(C-5<sub>Mann</sub>), 73.4(C-2<sub>Gul</sub>), 73.2, 72.5, 72.5, 72.2(CH<sub>2</sub>Bn), 70.2(C-4<sub>Gul</sub>), 68.9(C-5<sub>Gul</sub>), 52.4(-COOCH<sub>3</sub>), 52.2(-COOCH<sub>3</sub>), 21.2(CH<sub>3</sub> STol). [ $\alpha$ ]<sub>D</sub><sup>20</sup> = -16° (c = 0.42, CHCl<sub>3</sub>). IR (neat): 698, 737, 810, 947, 1028, 1072, 1088, 1121, 1209, 1304, 1456, 1749, 2311, 2349, 2378, 2922, 3030, 3450. HR-MS: [M+Na<sup>+</sup>] Calculated for C<sub>49</sub>H<sub>52</sub>O<sub>12</sub>S: 887.30717; found: 887.30827.

**Methyl (*p*-methylphenyl 2,3-di-*O*-benzyl-4-*O*-[methyl 2,3-di-*O*-benzyl-4-levulinoyl- $\alpha$ -L-gulopyranosyl uronate]-1-thio- $\alpha$ -D-mannopyranosyl uronate) (16):** EDCI (0.29 g, 0.151 mmol) and DIPEA

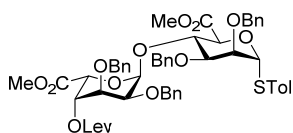

(0.25 ml, 0.144 mmol) were added to a solution of compound **15** (0.83 g, 0.096 mmol), levulinic acid (178 mg, 0.153 mmol) and DMAP (180 mg, 0.148 mmol) in DCM (4 ml) at 0 °C. The mixture was allowed to stir overnight at

room temperature, and then diluted with EtOAc, washed with sat. aq. NaCl. The organic phase was dried over Na<sub>2</sub>SO<sub>4</sub> and concentrated *in vacuo*. Purification by column chromatography (silica gel, pentane/DCM/EtOAc, 3/1/1, v/v/v) yielded **16** as a colourless oil (821 mg, 92%). TLC: R<sub>f</sub> = 0.74 (pentane/DCM/EtOAc, 1/1/1, v/v/v); <sup>1</sup>H NMR (CDCl<sub>3</sub>, 400 MHz, HH-COSY, HSQC):  $\delta$  7.58 – 6.83 (m, 24H, CH<sub>arom</sub>), 5.66 (d, *J* = 7.7 Hz, 1H, H-1<sub>Mann</sub>), 5.29 (m, 1H, H-4<sub>Gul</sub>), 5.16 (d, *J* = 4.0 Hz, 1H, H-1<sub>Gul</sub>), 4.87 (d, *J* = 11.7 Hz, 1H, CH<sub>2</sub>Bn), 4.80 (bs, 1H, H-5<sub>Gul</sub>), 4.78 – 4.29 (m, 8H, CH<sub>2</sub>Bn, H-5<sub>Mann</sub>, H-4<sub>Mann</sub>), 4.20 (d, *J* = 11.7 Hz, 1H, CH<sub>2</sub>Bn), 3.95 (t, *J* = 3.6 Hz, 1H, H-3<sub>Gul</sub>), 3.74 (m, 3H, H-2<sub>Gul</sub>, H-3<sub>Mann</sub>, H-2<sub>Mann</sub>), 3.63 (s, 3H, CH<sub>3</sub> COOCH<sub>3</sub>), 3.52 (s, 3H, CH<sub>3</sub> COOCH<sub>3</sub>), 2.86 – 2.57 (m, 2H, CH<sub>2</sub> Lev), 2.58 – 2.35 (m, 2H, CH<sub>2</sub> Lev), 2.28 (s, 3H, CH<sub>3</sub> STol), 2.17 (s, 3H, CH<sub>3</sub>CO); <sup>13</sup>C-APT NMR (CDCl<sub>3</sub>, 100 MHz, HSQC):  $\delta$  206.2(C=O Lev), 171.5,

## Chapter 3

169.5, 168.9(-COO-), 138.5, 137.9, 137.8(C<sub>q</sub> arom), 131.9(CH<sub>arom</sub>), 130.3(C<sub>q</sub> arom), 129.6, 128.5, 128.5, 128.4, 128.3, 128.0, 127.9, 127.9, 127.8, 127.7, 127.6, 127.6(CH<sub>arom</sub>), 97.6(C-1<sub>Gul</sub>), 83.1(C-1<sub>Mann</sub>, the chemical shift of this carbon is according to HSQC because it can not seen from carbon spectrum), 75.2(C-3<sub>Mann</sub>, C-4<sub>Mann</sub>), 74.8(C-2<sub>Mann</sub>, 74.0(C-5<sub>Mann</sub>), 73.4(CH<sub>2</sub>Bn), 73.0(C-2<sub>Gul</sub>), 72.6(C-3<sub>Gul</sub>), 72.5, 71.7(CH<sub>2</sub>Bn), 71.2(C-4<sub>Gul</sub>), 66.9(C-5<sub>Gul</sub>), 52.3(COOCH<sub>3</sub>), 52.1(COOCH<sub>3</sub>), 37.9(CH<sub>2</sub> Lev), 29.8(CH<sub>3</sub>CO), 28.0(CH<sub>2</sub> Lev), 21.2(CH<sub>3</sub> StOl). [ $\alpha$ ]<sup>20</sup><sub>D</sub> = -23° (c = 0.5, CHCl<sub>3</sub>). IR (neat): 698, 739, 1028, 1038, 1076, 1123, 1209, 1242, 1364, 1454, 1717, 1748, 2922. HR-MS: [M+H<sup>+</sup>] Calculated for C<sub>54</sub>H<sub>58</sub>O<sub>14</sub>S: 963.36200; found: 963.36433.

**Methyl (2,3-di-O-benzyl-4-O-[methyl 2,3-di-O-benzyl-4-levulinoyl- $\alpha$ -L-gulopyranosyl uronate]- $\alpha$ -D-mannopyranosyl uronate) (17):** NIS (170 mg, 0.756 mmol) and TFA (59  $\mu$ l) were added to a solution of **16** (724 mg, 0.752 mmol) in

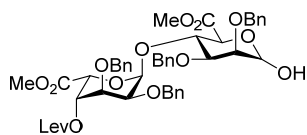

CH<sub>2</sub>Cl<sub>2</sub> (8 ml) at 0 °C. After analysis by TLC showed complete consumption of the starting material, the reaction was quenched with Et<sub>3</sub>N. Saturated Na<sub>2</sub>S<sub>2</sub>O<sub>3</sub> (aq) was added to the reaction mixture, which was then stirred for 30 min. The aqueous layer was extracted twice with CH<sub>2</sub>Cl<sub>2</sub>, and

concentrated *in vacuo*. Purification by column chromatography (silica gel, pentane/DCM/EtOAc, 3/1/1, v/v/v) yielded **17** as a colourless oil (587 mg, 91%). TLC: R<sub>f</sub> = 0.36 (pentane/DCM/EtOAc, 3/2/2, v/v/v); <sup>1</sup>H NMR (CDCl<sub>3</sub>, 400 MHz, HH-COSY, HSQC):  $\delta$  7.48 – 7.08 (m, 20H, CH<sub>arom</sub>), 5.48 (d, *J* = 6.0 Hz, 1H, H-1<sub>Mann</sub>), 5.28 (dt, *J* = 4.3, 2.2 Hz, 1H, H-4<sub>Gul</sub>), 5.18 (d, *J* = 3.8 Hz, 1H, H-1<sub>Gul</sub>), 4.86 – 4.81 (m, 2H, H-5<sub>Gul</sub>, CH<sub>2</sub>Bn), 4.72 – 4.41 (m, 8H, H-5<sub>Gul</sub>, CH<sub>2</sub>Bn, H-5<sub>Mann</sub>, H-4<sub>Mann</sub>), 4.32 (d, *J* = 12.0 Hz, 1H, CH<sub>2</sub>Bn), 3.93 (q, *J* = 3.3 Hz, 1H, H-3<sub>Gul</sub>), 3.84 (dd, *J* = 5.8, 2.8 Hz, 1H, H-3<sub>Mann</sub>), 3.78 – 3.68 (m, 1H, H-2<sub>Gul</sub>), 3.62 (s, 3H, CH<sub>3</sub> COOCH<sub>3</sub>), 3.60 – 3.53 (m, 1H, H-2<sub>Mann</sub>), 3.52 (s, 3H, CH<sub>3</sub> COOCH<sub>3</sub>), 2.69 (m, 2H, CH<sub>2</sub> Lev), 2.51 – 2.42 (m, 2H, CH<sub>2</sub> Lev), 2.16 (s, 3H, CH<sub>3</sub>CO); <sup>13</sup>C-APT NMR (CDCl<sub>3</sub>, 100 MHz, HSQC):  $\delta$  206.3(C=O Lev), 171.5, 169.9, 168.8(-COO-), 138.5, 137.8 C<sub>q</sub> arom), 128.5, 128.4, 128.3, 128.2, 128.1, 128.0, 127.9, 127.8, 127.7, 127.6, 127.5, 127.4(CH<sub>arom</sub>), 97.7(C-1<sub>Gul</sub>), 92.7(C-1<sub>Mann</sub>), 76.6(C-3<sub>Mann</sub>), 76.4(C-2<sub>Mann</sub>), 75.2(C-4<sub>Mann</sub>), 73.6(C-5<sub>Mann</sub>), 73.2, 72.9(CH<sub>2</sub>Bn), 72.7(C-2<sub>Gul</sub>), 72.5(C-3<sub>Gul</sub>), 72.3, 71.6(CH<sub>2</sub>Bn), 70.9(C-4<sub>Gul</sub>), 66.7(C-5<sub>Gul</sub>), 52.3(COOCH<sub>3</sub>), 52.2(COOCH<sub>3</sub>), 37.9(CH<sub>2</sub> Lev), 29.8(CH<sub>3</sub>CO), 28.0(CH<sub>2</sub> Lev); <sup>13</sup>C-HMBCipvGATED (CDCl<sub>3</sub>, 100 MHz): 97.7(*J*<sub>C1,H1</sub> = 170Hz, C-1<sub>Gul</sub>), 92.7(*J*<sub>C1,H1</sub> = 170Hz, C-1<sub>Mann</sub>). IR (neat): 677, 698, 735, 814, 908, 926, 957, 1026, 1074, 1088, 1121, 1207, 1240, 1304, 1362, 1454, 1717, 1744, 2924, 2951. HR-MS: [M+H<sup>+</sup>] Calculated for C<sub>47</sub>H<sub>52</sub>O<sub>15</sub>: 857.33790; found: 857.33937.

**Methyl (2,3-di-O-benzyl-4-O-[methyl 2,3-di-O-benzyl-4-levulinoyl- $\alpha$ -L-gulopyranosyl uronate]-1-O-(*N*-phenyl trifluoroacetimidoyl)- $\alpha$ / $\beta$ -D-mannopyranosyl uronate) (18):** Compound

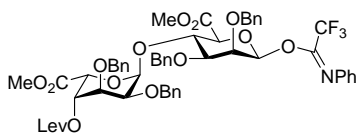

**17** (580 mg, 0.677 mmol) was dissolved in acetone (6 ml) and the solution was cooled to 0 °C. *N*-phenyl trifluoroacetimidoyl chloride (211 mg, 1.02 mmol) and potassium carbonate (112 mg, 0.812 mmol) were added and the resulting suspension was stirred overnight at

## Reactivity of Gulose and Guluronic acid Building blocks

room temperature. Then, Et<sub>3</sub>N was added to the reaction mixture, which was filtered and the resulting filtrate was concentrated *in vacuo*. Purification by column chromatography (silica gel, pentane/DCM/EtOAc, 3/1/1, v/v/v) yielded **18** as a colourless syrup (680 mg, 98%,  $\alpha:\beta = 3.9:1$ ). TLC: R<sub>f</sub> = 0.43 (pentane/DCM/EtOAc, 2/1/1, v/v/v); <sup>1</sup>H NMR (CD<sub>3</sub>COCD<sub>3</sub>, 400 MHz, HH-COSY, HSQC):  $\delta$  7.60 – 7.13 (m, 22H, CH<sub>arom</sub>), 7.08 (t,  $J = 7.5$  Hz, 1H, CH<sub>arom</sub>), 6.88 – 6.74 (m, 2H, CH<sub>arom</sub>), 6.44 (bs, 1H, H-1<sub>Mann</sub>), 5.37 – 5.14 (m, 2H, H-1<sub>Gul</sub>, H-4<sub>Gul</sub>), 4.97 (bs, 1H, H-5<sub>Gul</sub>), 4.88 (d,  $J = 11.5$  Hz, 1H, CH<sub>2</sub>Bn), 4.75 – 4.28 (m, 9H, CH<sub>2</sub>Bn, H-5<sub>Mann</sub>, H-4<sub>Mann</sub>), 4.12 – 3.85 (m, 3H, H-3<sub>Gul</sub>, H-3<sub>Mann</sub>, H-2<sub>Mann</sub>), 3.81 (t,  $J = 3.6$  Hz, 1H, H-2<sub>Gul</sub>), 3.60 (s, 3H, CH<sub>3</sub> COOCH<sub>3</sub>), 3.58 (s, 3H, CH<sub>3</sub> COOCH<sub>3</sub>), 2.70 (m, 2H, CH<sub>2</sub> Lev), 2.42 (m, 2H, CH<sub>2</sub> Lev), 2.08 (s, 3H, CH<sub>3</sub>CO); <sup>13</sup>C-APT NMR (CD<sub>3</sub>COCD<sub>3</sub>, 100 MHz, HSQC):  $\delta$  206.7(C=O Lev), 172.1, 169.5, 169.1(-COO-), 140.0, 139.5, 139.2, 138.8 C<sub>q</sub>arom), 129.7, 129.6, 129.2, 129.1, 129.1, 129.0, 128.9, 128.7, 128.6, 128.6, 128.5, 128.4, 128.4, 128.3, 128.3, 128.1, 128.0, 125.2, 124.8, 120.3(CH<sub>arom</sub>), 97.8(C-1<sub>Gul</sub>), 95.5(C-1<sub>Mann</sub>), 77.2(C-3<sub>Mann</sub>), 75.4(C-2<sub>Mann</sub>), 75.3(C-4<sub>Mann</sub>), 74.5(C-2<sub>Gul</sub>), 74.2(C-5<sub>Mann</sub>), 74.0(C-2<sub>Gul</sub>), 73.8(C-3<sub>Gul</sub>), 73.7, 73.1, 72.2, 71.8(CH<sub>2</sub>Bn), 71.7(C-4<sub>Gul</sub>), 67.6(C-5<sub>Gul</sub>), 52.6(COOCH<sub>3</sub>), 52.3(COOCH<sub>3</sub>), 38.3(CH<sub>2</sub> Lev), 28.7 (CH<sub>2</sub> Lev). HR-MS: [M+Na<sup>+</sup>] Calculated for C<sub>55</sub>H<sub>56</sub>O<sub>15</sub>F<sub>3</sub>N: 1050.34943; found: 1050.35019.

### The synthesis of disaccharide acceptor (20)

#### *p*-methoxyl benzyl 4,6-*O*-benzylidene-3-*O*-(*tert*-butyl-di-methyl)-silyl-1-thio- $\alpha$ -D-mannopyranoside (**36**)

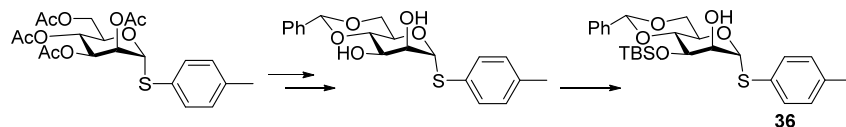

The starting material *p*-methyl phenyl 2,3,4,6-tetra-*O*-acetyl-1-thio- $\alpha$ -D-mannopyranoside (4.81 g, 10.58 mmol) was dissolved in MeOH (100 ml) and then the catalytic amount NaOMe was added. The reaction was allowed to stir for overnight at room temperature. The mixture was neutralized with Amberlite IR120 (H<sup>+</sup>) resin, filtered, and concentrated under reduced pressure. The residue was dried over *in vacuo*, which was used in the next step without further purification. To a solution of *p*-methyl phenyl 1-thio- $\alpha$ -D-mannopyranoside in anhydrous DMF (20 mL) were added, successively with stirring under argon at 0 °C,  $\alpha,\alpha$ -dimethoxytoluene (2.38 mL, 15.9 mmol) and tetrafluoroboric acid diethyl ether complex (1.81 mL, 13.3 mmol). The mixture was stirred at room temperature overnight, neutralized with Et<sub>3</sub>N (20 mL), and concentrated under reduced pressure. The residue, a yellow-orange solid, diluted with EtOAc, washed with sat. aq. NaCl, the organic phase was dried over Na<sub>2</sub>SO<sub>4</sub> and concentrated *in vacuo*. Which was used in the next step without further purification.<sup>[4]</sup> After *p*-methoxyl benzyl 4,6-*O*-benzylidene-1-thio- $\alpha$ -D-mannopyranoside was dissolved in anhydrous DMF (14 ml), imidazole (1.44 g, 21.16 mmol) and TBSCl (1.44 g, 9.52 mmol) were added to the mixture at 0 °C. Then the mixture was stirred at room temperature overnight, quenched with MeOH (10 mL), and concentrated under reduced pressure. The residue was diluted with EtOAc, washed with sat. aq. NaCl, the organic phase was dried over Na<sub>2</sub>SO<sub>4</sub> and concentrated *in vacuo*. Purification

## Chapter 3

by column chromatography (silica gel, pentane/EtOAc, 20/1, v/v) yielded **36** as a colourless foam (1.72 g, four steps yield: 33%). TLC:  $R_f = 0.52$  (pentane/EtOAc, 8/1, v/v);  $[\alpha]_D^{20} = +167^\circ$  ( $c = 1$ ,  $\text{CHCl}_3$ ).  $^1\text{H}$  NMR ( $\text{CDCl}_3$ , 400 MHz, HH-COSY, HSQC):  $\delta$  7.59 – 7.43 (m, 2H, CH STol), 7.43 – 7.29 (m, 5H,  $\text{CH}_{\text{arom}}$ ), 7.14 (d,  $J = 8.2$  Hz, 2H, CH STol), 5.58 (s, 1H, H-1), 5.56 (s, 1H, CH benzylidene), 4.34 (m, 1H, H-5), 4.26 – 4.06 (m, 3H, H-2, H-3, H-6), 4.03 – 3.72 (m, 2H, H-4, H-6), 2.34 (s, 3H,  $\text{CH}_3$  STol), 0.91 (d,  $J = 3.0$  Hz, 9H, TBS), 0.14 (s, 3H, TBS), 0.09 (s, 3H, TBS).  $^{13}\text{C}$  –APT NMR ( $\text{CDCl}_3$ , 100 MHz, HSQC):  $\delta$  138.1, 137.5( $\text{C}_{\text{q arom}}$ ), 132.5, 130.1( $\text{CH}_{\text{arom}}$ ), 129.6( $\text{C}_{\text{q arom}}$ ), 129.0, 128.3, 126.2( $\text{CH}_{\text{arom}}$ ), 102.0(CH benzylidene), 88.0(C-1), 79.3(C-4), 73.4(C-2), 70.2(C-3), 68.6(C-6), 64.5(C-5), 25.9( $\text{CH}_3$  *tert*-Bu), 21.3( $\text{CH}_3$  STol), 18.3( $\text{C}_q$  *tert*-Bu), -4.2( $\text{CH}_3$  TBS), -4.9( $\text{CH}_3$  TBS). IR (neat): 610, 675, 696, 748, 777, 808, 835, 851, 966, 1005, 1084, 1211, 1252, 1379, 1462, 1493, 2857, 2893, 2927, 2951. HR-MS:  $[\text{M}+\text{H}^+]$  Calculated for  $\text{C}_{26}\text{H}_{36}\text{O}_5\text{Si}$ : 489.21255; found: 489.21238.

### The synthesis of monosaccharide acceptor *p*-methyl phenyl 2-*O*-benzyl-1-thio- $\alpha$ -D-mannopyranosidurone-6,3-lactone (**38**)

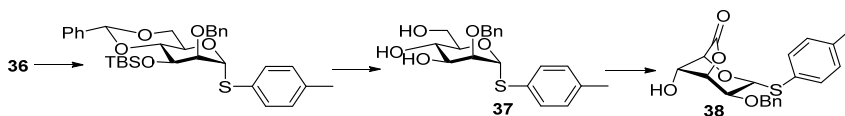

BnBr (380  $\mu\text{l}$ , 3.0 mmol) and NaH 60% dispersion in mineral oil (120 mg, 3.0 mmol) were added to the mixture of *p*-methyl phenyl 4,6-*O*-benzylidene-3-*O*-(*tert*-butyl-di-methyl)-silyl-1-thio- $\alpha$ -D-mannopyranoside **36** (733 mg, 1.5 mmol) in DMF (10 ml) at 0  $^\circ\text{C}$ . And then the mixture was stirred at room temperature overnight, quenched with  $\text{H}_2\text{O}$ , diluted with EtOAc, washed with sat. aq. NaCl, the organic phase was dried over  $\text{Na}_2\text{SO}_4$  and concentrated in vacuo. Which was used in the next step without further purification. The residue was dissolved in MeOH (20 ml), and then  $\text{TsOH}/\text{H}_2\text{O}$  was added to the mixture until the PH = 2. Then the mixture was stirred at room temperature overnight, quenched with  $\text{Et}_3\text{N}$  (0.5 mL), and concentrated under reduced pressure. The residue was diluted with EtOAc, washed with sat. aq. NaCl, the organic phase was dried over  $\text{Na}_2\text{SO}_4$  and concentrated in vacuo. Purification by column chromatography (silica gel, pentane/EtOAc, 1/1, v/v) yielded **37** as a white solid (350 mg, two steps yield: 62%). TLC:  $R_f = 0.26$  (pentane/EtOAc, 1/1, v/v);  $^1\text{H}$  NMR ( $\text{CDCl}_3$ , 400 MHz, HH-COSY, HSQC):  $\delta$  7.31-7.12 (m, 9H,  $\text{CH}_{\text{arom}}$ ), 5.49 (d,  $J = 7.5$  Hz, 1H, H-1), 4.85 – 4.61 (m, 1H,  $\text{CH}_2$  Bn), 4.52 (dd,  $J = 11.7, 3.3$  Hz, 1H,  $\text{CH}_2$  Bn), 4.18 – 3.82 (m, 6H, H-2, H-3, H-4, H-5, H-6), 2.33 (s, 3H,  $\text{CH}_3$  STol).  $^{13}\text{C}$  –APT NMR ( $\text{CDCl}_3$ , 100 MHz, HSQC):  $\delta$  138.2, 137.3( $\text{C}_{\text{q arom}}$ ), 132.7, 130.1, 128.8, 128.2( $\text{CH}_{\text{arom}}$ ), 85.9(C-1), 79.5(C-2), 72.7( $\text{CH}_2$  Bn), 73.0, 72.0, 69.0(C-3, C-4, C-5), 62.3(C-6), 21.3( $\text{CH}_3$  STol).  $[\alpha]_D^{20} = +100^\circ$  ( $c = 0.42$ ,  $\text{CHCl}_3$ ). IR (neat): 665, 698, 737, 764, 791, 845, 914, 1018, 1040, 1069, 1099, 1207, 1352, 1398, 1454, 1493, 2920, 3298, 3366. HR-MS:  $[\text{M}+\text{Na}^+]$  Calculated for  $\text{C}_{20}\text{H}_{24}\text{O}_5\text{S}$ : 399.12367; found: 399.12361.



## Reactivity of Gulose and Guluronic acid Building blocks

***p*-methyl phenyl 2-*O*-benzyl-1-thio- $\alpha$ -D-mannopyranoside-6,3-lactone (38):** *p*-methoxy phenyl 2-*O*-benzyl-1-

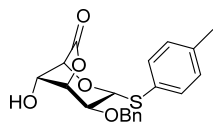

thio- $\alpha$ -D-mannopyranoside **37** (75 mg, 0.2mmol) was dissolved in DCM/*tert*-Buol/H<sub>2</sub>O (3 ml, 1/1/1,v/v/v), the mixture was cooled to 0 °C and treated with TEMPO (8 mg, 0.051 mmol) and BAIB (161 mg, 0.5 mmol). After stirring for overnight at 4 °C, Na<sub>2</sub>S<sub>2</sub>O<sub>3</sub> was added, diluted with EtOAc, washed with sat. aq. NaCl, the organic phase was dried

over Na<sub>2</sub>SO<sub>4</sub> and concentrated in vacuo. The crude residue was dissolved in DCM (7 ml), followed by the addition of DIPEA (45  $\mu$ l, 0.25 mmol) and ethyl chloroformate (24  $\mu$ l, 0.25 mmol) at 0 °C. The mixture was allowed to stir for 3 h at room temperature, and then diluted with EtOAc, washed with sat. aq. NaCl, the organic phase was dried over Na<sub>2</sub>SO<sub>4</sub> and concentrated in vacuo. Purification by column chromatography (silica gel, pentane /EtOAc, 2/1, v/v) yielded **38** as a colourless form (28 mg, 38%).<sup>[5]</sup> TLC: R<sub>f</sub> = 0.22 (pentane/ EtOAc, 2/1, v/v); <sup>1</sup>H NMR (CDCl<sub>3</sub>, 400 MHz,HH-COSY, HSQC):  $\delta$  7.48 – 7.27 (m, 7H, CH<sub>arom</sub>), 7.12 (d, *J* = 8.1 Hz, 2H, CH<sub>arom</sub>), 4.94 – 4.57 (m, 4H, H-1, H-3, CH<sub>2</sub> Bn), 4.34 – 4.00 (m, 2H, H-4, H-5), 3.78 (dd, *J* = 8.9, 1.7 Hz, 1H, H-2), 2.33 (s, 3H, CH<sub>3</sub> STol); <sup>13</sup>C –APT NMR (CDCl<sub>3</sub>, 100 MHz, HSQC):  $\delta$  169.8(-COO-), 139.2, 137.2(C<sub>q</sub>arom), 133.8, 130.1, 128.6, 128.2, 128.2, 127.8(CH<sub>arom</sub>), 84.6(C-1), 78.6(C-3), 73.9(C-5), 73.4(C-2), 73.1(CH<sub>2</sub> Bn), 69.4(C-4), 21.3(CH<sub>3</sub> STol). [ $\alpha$ ]<sub>D</sub><sup>20</sup> = +42° (c = 1, CHCl<sub>3</sub>). IR (neat): 698, 737, 810, 876, 930, 1002, 1016, 1038, 1074, 1090, 1157, 1209, 1258, 1360, 1398, 1454, 1748, 1797, 2922. HR-MS: [M+Na<sup>+</sup>] Calculated for C<sub>20</sub>H<sub>20</sub>O<sub>5</sub>S: 373.11042; found: 373.11040.

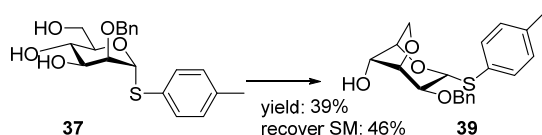

**synthesis of 39:** *p*-methyl phenyl 2-*O*-benzyl-1-thio- $\alpha$ -D-mannopyranoside **37** (347 mg, 0.923 mmol) was dissolved

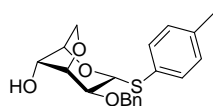

in DCM (4 ml), the mixture was cooled to -10 °C and treated with lutidine (161  $\mu$ l, 1.385 mmol), DIPEA (241 mg, 1.385 mmol) and then Tf<sub>2</sub>O (186  $\mu$ l, 1.11 mmol). After stirring for overnight at 0 °C, diluted with EtOAc, washed with sat. aq. NaCl, the organic phase was dried over Na<sub>2</sub>SO<sub>4</sub> and concentrated in vacuo. Purification by column chromatography (silica gel, pentane/EtOAc, 3/2, v/v) yielded **39** as a colourless form (130 mg, 39%) and recover starting material SI-2 (159 mg).

TLC: R<sub>f</sub> = 0.22 (pentane/ EtOAc, 2/1, v/v); <sup>1</sup>H NMR (CDCl<sub>3</sub>, 400 MHz,HH-COSY, HSQC):  $\delta$  7.51 – 7.26 (m, 7H, CH<sub>arom</sub>), 7.12 (d, *J* = 8.1 Hz, 2H, CH<sub>arom</sub>), 5.00 (d, *J* = 8.7 Hz, 1H, H-1), 4.68 (q, *J* = 11.7 Hz, 2H, CH<sub>2</sub> Bn), 4.34 – 4.02 (m, 4H, H-3, H-5, H-4, H-6), 3.93 (dd, *J* = 10.9, 3.0 Hz, 1H, H-6), 3.55 (dd, *J* = 8.7, 1.6 Hz, 1H, H-2), 2.33 (s, 3H, CH<sub>3</sub> STol); <sup>13</sup>C –APT NMR (CDCl<sub>3</sub>, 100 MHz, HSQC):  $\delta$  138.7, 137.8(C<sub>q</sub>arom), 133.9, 129.9(CH<sub>arom</sub>), 128.4(C<sub>q</sub>arom), 128.4, 128.2, 127.9(CH<sub>arom</sub>), 83.2(C-1), 76.7(C-5), 75.6(C-3), 74.6(C-2), 72.5(CH<sub>2</sub> Bn), 71.4(C-4), 68.5(C-6), 21.2(CH<sub>3</sub> STol). [ $\alpha$ ]<sub>D</sub><sup>20</sup> = +76° (c = 1, CHCl<sub>3</sub>). IR (neat): 633, 696, 733, 808, 853, 924, 943, 962, 995, 1018, 1058, 1092, 1101, 1263, 1317, 1454, 1493, 2922, 3372. HR-MS: [M+Na<sup>+</sup>] Calculated for C<sub>20</sub>H<sub>22</sub>O<sub>4</sub>S: 359.13116; found: 359.13114.

## Chapter 3

### The glycosylation of the imidate donor **3** with the locked $^1C_4$ conformational acceptor **38**

Imidate donor **7** (162 mg, 0.242 mmol) and acceptor **38** (60 mg, 0.161 mmol) were together co-evaporated with toluene (three times). The residue was dissolved in dry DCM (1.6 ml). The solution was cooled to  $-78\text{ }^\circ\text{C}$  and followed by adding TBSOTf (7.4  $\mu\text{l}$ , 0.032 mmol) and the reaction was allowed to stir for overnight at  $-78\text{ }^\circ\text{C}$  to  $-20\text{ }^\circ\text{C}$ . The reaction was quenched with  $\text{Et}_3\text{N}$  and diluted with EtOAc, washed with sat. aq. NaCl, the organic phase was dried over  $\text{Na}_2\text{SO}_4$  and concentrated in vacuo. Purification by column chromatography (silica gel, pentane/EtOAc, 2/1, v/v to DCM/MeOH, 10/1, v/v) yielded **41** as a colourless syrup (89 mg, 58%). TLC:  $R_f = 0.39$  (DCM/MeOH, 10/1, v/v). For this reaction, the glycosylation product **40** was not stable in basic condition, the lactone ring was opened and yield the salt of  $\text{Et}_3\text{N}$  **41**.  $^1\text{H}$  NMR ( $\text{CDCl}_3$ , 400 MHz, HH-COSY, HSQC):  $\delta$  7.68 – 6.84 (m, 19H,  $\text{CH}_{\text{arom}}$ ), 5.72 – 5.44 (m, 1H, H-1 $_{\text{Mann}}$ ), 5.22 (s, 1H, H-1 $_{\text{Gul}}$ ), 4.90 (d,  $J = 11.9$  Hz, 1H,  $\text{CH}_2\text{Bn}$ ), 4.77 – 4.49 (m, 5H,  $\text{CH}_2\text{Bn}$ ), 4.40 – 3.74 (m, 9H), 3.16 – 2.85 (m, 6H,  $\text{NEt}_3$ ), 2.26 (s, 3H( $\text{CH}_3$  STol)), 1.13 (t,  $J = 7.4$  Hz, 9H,  $\text{NEt}_3$ ), 0.98 (s, 9H,  $3\times\text{CH}_3$  *tert*-Bu), 0.86 (s, 9H,  $3\times\text{CH}_3$  *tert*-Bu);  $^{13}\text{C}$  NMR (101 MHz,  $\text{CDCl}_3$ ):  $\delta$  138.6, 137.9, 137.7( $\text{C}_{\text{q arom}}$ ), 130.3( $\text{CH}_{\text{arom}}$ ), 128.5( $\text{C}_{\text{q arom}}$ ), 128.4, 128.4, 128.3, 128.2, 128.0, 127.8( $\text{CH}_{\text{arom}}$ ), 114.1, 97.1( $\text{C-1}_{\text{Gul}}$ ), 85.0( $\text{C-1}_{\text{Mann}}$ ), 77.7, 77.5, 76.4, 75.9, 73.4, 72.7, 72.3, 71.7, 71.6, 71.2, 70.8, 69.6, 67.0, 45.4( $\text{CH}_2$   $\text{NEt}_3$ ), 27.6( $\text{CH}_3$  *tert*-Bu), 27.2( $\text{CH}_3$  *tert*-Bu), 23.3( $\text{C}_{\text{q tert-Bu}}$ ), 21.2( $\text{CH}_3$  STol), 20.4( $\text{C}_{\text{q tert-Bu}}$ ), 8.4( $\text{CH}_3$   $\text{NEt}_3$ ). IR (neat): 602, 638, 650, 696, 735, 797, 825, 860, 885, 935, 1018, 1028, 1083, 1138, 1209, 1242, 1362, 1454, 1472, 1602, 1743, 2857, 2930. HR-MS:  $[\text{M}+\text{H}^+]$  Calculated for  $\text{C}_{48}\text{H}_{60}\text{O}_{11}\text{SSi}$ : 873.36984; found: 873.37065.

### The synthesis of disaccharide acceptor (20)

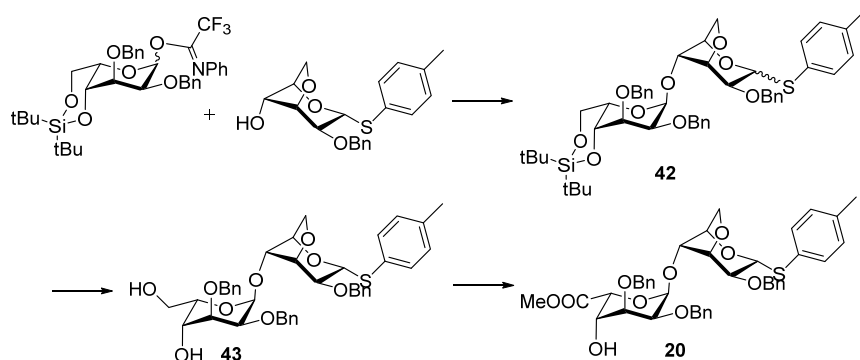

As described for the synthesis of **13** using **7** and **12**. The **42**, the 1-thio- $\alpha$ -D-mannopyranoside was epimerized in glycosylation condition ( $\alpha/\beta = 5/1$ ), was obtained (152 mg, 81%). TLC:  $R_f = 0.20$  (PhMe/EtOAc, 4/3, v/v).  $[\alpha]_D^{20} = -22^\circ$  ( $c = 1$ ,  $\text{CHCl}_3$ ).  $^1\text{H}$  NMR ( $\text{CDCl}_3$ , 400 MHz, HH-COSY, HSQC):  $\delta$  7.65 – 7.54 (m, 2H,  $\text{CH}_{\text{arom}}$ ), 7.53 – 7.24 (m, 15H,  $\text{CH}_{\text{arom}}$ ), 7.15 (d,  $J = 8.1$  Hz, 2H,  $\text{CH}_{\text{arom}}$ ), 5.44 (d,  $J = 2.1$  Hz, 0.2H), 5.33 – 5.14 (m, 4H), 5.00 (d,  $J = 12.1$  Hz, 1H), 4.88 – 4.67 (m, 3H), 4.64 – 4.49 (m, 3H), 4.46 – 4.31 (m, 5H), 4.31 – 3.95 (m, 8H), 3.88 (dd,  $J = 8.9, 1.5$  Hz, 1H), 3.66 – 3.60 (m, 0.2H), 2.38 (s, 3H);  $^{13}\text{C}$  NMR (101 MHz,  $\text{CDCl}_3$ ):  $\delta$  139.5, 138.3, 138.2, 137.1, 131.7, 131.6, 129.7, 128.5, 128.3, 128.2, 128.0, 128.0, 127.6, 127.5, 127.4, 97.9, 95.6, 85.4, 83.0, 78.0, 77.1, 76.3, 75.9, 74.0, 73.3, 73.0, 72.9,

## Reactivity of Gulose and Gulosonic acid Building blocks

72.8, 72.6, 72.0, 71.5, 71.2, 69.7, 67.0, 65.0, 27.7, 27.2, 23.3, 21.2, 20.5. IR (neat): 650, 696, 737, 799, 826, 862, 937, 1001, 1028, 1067, 1086, 1105, 1118, 1141, 1454, 1472, 1495, 2857, 2889, 2932. HR-MS:  $[M+Na]^+$  Calculated for  $C_{48}H_{60}O_9Si$ : 863.36195; found: 863.36157.

As described in the general procedure for deprotecting of di-*tert*-butyl silylation. The **43** was obtained (85 mg,

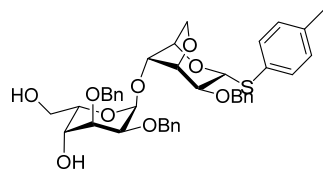

71%). TLC:  $R_f = 0.20$  (DCM/acetone, 5/1, v/v).  $[\alpha]_D^{20} = -36^\circ$  (c = 1,  $CHCl_3$ ).  $^1H$  NMR ( $CDCl_3$ , 400 MHz, HH-COSY, HSQC):  $\delta$  7.53 – 7.16 (m, 17H,  $CH_{arom}$ ), 7.07 (d,  $J = 8.3$  Hz, 2H,  $CH_{arom}$ ), 5.19 (d,  $J = 3.8$  Hz, 1H, H-1<sub>Gul</sub>), 5.13 (d,  $J = 8.9$  Hz, 1H, H-1<sub>Mann</sub>), 4.96 (d,  $J = 12.2$  Hz, 1H,  $CH_2Bn$ ), 4.87 (d,  $J = 12.2$  Hz, 1H,  $CH_2Bn$ ), 4.62 (dd,  $J = 20.5, 12.1$  Hz, 2H,  $CH_2Bn$ ), 4.50 (d,  $J = 11.5$  Hz,

1H,  $CH_2Bn$ ), 4.45 (t,  $J = 2.8$  Hz, 1H, H-5<sub>Mann</sub>), 4.41 – 4.28 (m, 2H, H-3<sub>Mann</sub>,  $CH_2Bn$ ), 4.22 (dd,  $J = 6.3, 2.6$  Hz, 1H, H-4<sub>Mann</sub>), 4.09 (d,  $J = 10.7$  Hz, 1H, H-6<sub>Mann</sub>), 4.06 – 3.71 (m, 8H, H-5<sub>Gul</sub>, H-4<sub>Gul</sub>, H-2<sub>Gul</sub>, H-6<sub>Mann</sub>, H-3<sub>Gul</sub>, H-2<sub>Mann</sub>, H-6<sub>Gul</sub>), 3.61 (bs, 1H, -OH), 2.29 (s, 3H,  $CH_3$  STol).  $^{13}C$  –APT NMR ( $CDCl_3$ , 100 MHz, HSQC):  $\delta$  139.1, 138.5, 138.1, 137.3 ( $C_q$  arom), 131.7 ( $CH_{arom}$ ), 131.7 ( $C_q$  arom), 129.7, 128.4, 128.4, 128.3, 128.3, 127.7, 127.7, 127.6, 127.5, 127.5 ( $CH_{arom}$ ), 95.9 (C-1<sub>Gul</sub>), 85.4 (C-1<sub>Mann</sub>), 76.6, 76.1, 75.8 (C-2<sub>Mann</sub>, C-3<sub>Mann</sub>, C-3<sub>Gul</sub>), 74.2 (C-4<sub>Mann</sub>), 73.6 (C-2<sub>Gul</sub>), 73.0 ( $CH_2Bn$ ), 72.9 (C-5<sub>Mann</sub>), 71.8 ( $CH_2Bn$ ), 71.7 (C-5<sub>Gul</sub>), 69.7 (C-6<sub>Mann</sub>), 67.1 (C-4<sub>Gul</sub>), 63.8 (C-6<sub>Gul</sub>), 21.2 ( $CH_3$  STol). IR (neat): 696, 735, 810, 930, 943, 966, 999, 1026, 1058, 1101, 1209, 1265, 1312, 1354, 1454, 1493, 2889, 2920, 3433. HR-MS:  $[M+Na]^+$  Calculated for  $C_{40}H_{44}O_9S$ : 723.25982; found: 723.25911.

Disaccharide acceptor **20**, as described in the general procedure for oxidation and subsequent methylation. The

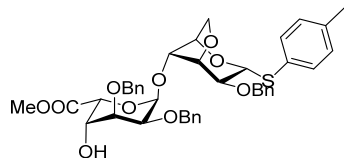

disaccharide acceptor **20** was obtained (81 mg, 97%). TLC:  $R_f = 0.23$  (DCM/acetone, 15/1, v/v).  $[\alpha]_D^{20} = -38^\circ$  (c = 0.58,  $CHCl_3$ ).  $^1H$  NMR ( $CDCl_3$ , 400 MHz, HH-COSY, HSQC):  $\delta$  7.54 – 6.98 (m, 19H,  $CH_{arom}$ ), 5.31 (d,  $J = 3.4$  Hz, 1H, H-1<sub>Gul</sub>), 5.13 (d,  $J = 8.9$  Hz, 1H, H-1<sub>Mann</sub>), 4.89 (dd,  $J = 12.1, 2.2$  Hz, 2H,  $CH_2Bn$ ), 4.76 (d,  $J = 2.8$  Hz, 1H, H-5<sub>Gul</sub>), 4.71 – 4.19 (m, 7H, H-

5<sub>Mann</sub>, H-3<sub>Gul</sub>, H-4<sub>Gul</sub>, H-4<sub>Mann</sub>,  $CH_2Bn$ ), 4.13 (d,  $J = 10.8$  Hz, 1H, H-6<sub>Mann</sub>), 4.02 – 3.68 (m, 7H, H-6<sub>Mann</sub>, H-2<sub>Gul</sub>, H-3<sub>Mann</sub>, H-2<sub>Mann</sub>,  $CH_3OCO$ ), 2.49 (d,  $J = 5.8$  Hz, 1H, -OH), 2.30 (s, 3H,  $CH_3$  STol);  $^{13}C$  –APT NMR ( $CDCl_3$ , 100 MHz, HSQC):  $\delta$  170.4 (– $COOCH_3$ ), 138.8, 138.4, 138.1, 137.4 ( $C_q$  arom), 131.9 ( $CH_{arom}$ ), 131.5 ( $C_q$  arom), 129.8, 128.5, 128.4, 128.4, 128.2, 128.0, 127.7, 127.7, 127.6 ( $CH_{arom}$ ), 96.3 (C-1<sub>Gul</sub>), 85.3 (C-1<sub>Mann</sub>), 76.4 (C-3<sub>Mann</sub>), 76.1 (C-2<sub>Mann</sub>), 75.6 (C-3<sub>Gul</sub>), 74.7 (C-4<sub>Mann</sub>), 73.3 (C-2<sub>Gul</sub>), 73.0 ( $CH_2Bn$ ), 72.9 (C-5<sub>Mann</sub>), 72.5 ( $CH_2Bn$ ), 70.0 (C-4<sub>Gul</sub>), 69.7 (C-6<sub>Mann</sub>), 69.6 (C-5<sub>Gul</sub>), 52.6 (– $COOCH_3$ ), 21.2 ( $CH_3$  STol). IR (neat): 696, 735, 810, 856, 928, 1001, 1026, 1062, 1115, 1146, 1209, 1308, 1358, 1439, 1454, 2924, 2953, 3412. HR-MS:  $[M+Na]^+$  Calculated for  $C_{41}H_{44}O_{10}S$ : 751.25474; found: 751.25436.

## The synthesis of disaccharide acceptor (21)

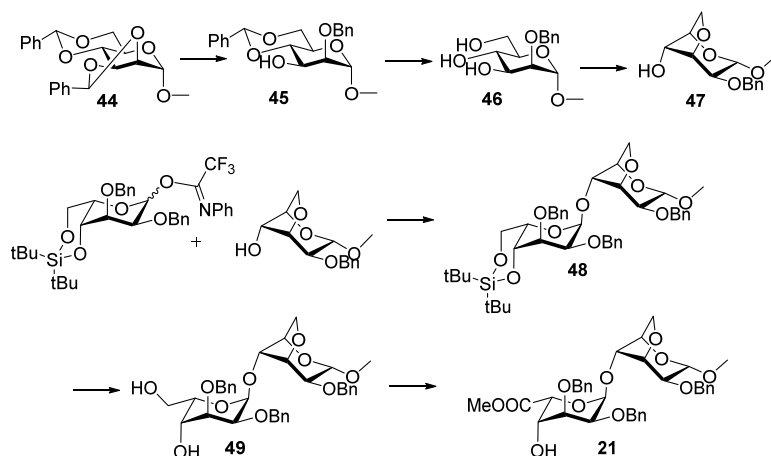

Methyl 2,3,4,6-*O*-di-benzylidene-1-thio- $\alpha$ -D-mannopyranoside **44** (200 mg, 0.54 mmol) was dissolved in toluene (11 ml) and cooled to  $-40^{\circ}\text{C}$ , then DIBAL-H (1 M, 1.62 ml, 1.62 mmol) was added to the mixture. The mixture was allowed to stir 2 h at room temperature, diluted with EtOAc, washed with sat. aq. NaCl, the organic phase was dried over  $\text{Na}_2\text{SO}_4$  and concentrated in vacuo. Which was used in the next step without further purification. The residue was dissolved in MeOH (10 ml), and then TsOH/ $\text{H}_2\text{O}$  was added to the mixture until the PH = 2. Then the mixture was stirred at room temperature overnight, quenched with  $\text{Et}_3\text{N}$  (0.5 mL), and concentrated under reduced pressure. The residue was diluted with EtOAc, washed with sat. aq. NaCl, the organic phase was dried over  $\text{Na}_2\text{SO}_4$  and concentrated in vacuo. Purification by column chromatography (silica gel, pentane/EtOAc, 1/2, v/v) yielded **46**<sup>[6]</sup> as a white solid (134 mg, two steps yield: 62%). TLC:  $R_f$  = 0.11 (pentane/EtOAc, 5/7, v/v);

As described for the synthesis of **39** using **37**. The compound **47** was obtained (65 mg, 53%). TLC:  $R_f$  = 0.20

(pentane/EtOAc, 5/7, v/v);  $[\alpha]_{\text{D}}^{20} = +43^{\circ}$  ( $c = 1$ ,  $\text{CHCl}_3$ ).  $^1\text{H}$  NMR ( $\text{CDCl}_3$ , 400 MHz, HH-COSY, HSQC):  $\delta$  7.42 – 7.22 (m, 5H,  $\text{CH}_{\text{arom}}$ ), 4.82 (d,  $J = 6.5$  Hz, 1H, H-1), 4.73 (d,  $J = 12.0$  Hz, 1H,  $\text{CH}_2\text{Bn}$ ), 4.62 (d,  $J = 12.2$  Hz, 1H,  $\text{CH}_2\text{Bn}$ ), 4.29 – 4.13 (m, 3H, H-3, H-5, H-4), 4.07 (d,  $J = 10.6$  Hz, 1H, H-6), 3.94 (dd,  $J = 10.7, 2.9$  Hz, 1H, H-6), 3.60 (dd,  $J = 6.7, 1.6$  Hz, 1H, H-2), 3.55 (s, 3H,  $-\text{OCH}_3$ );  $^{13}\text{C}$  –APT NMR ( $\text{CDCl}_3$ , 100 MHz, HSQC):  $\delta$  138.2( $\text{C}_{\text{q arom}}$ ), 128.4, 127.9( $\text{CH}_{\text{arom}}$ ), 103.13(C-1), 76.4(C-2), 76.3(C-3), 75.4(C-5), 72.7( $\text{CH}_2\text{Bn}$ ), 71.4(C-4), 69.1(C-6), 57.4(OMe). IR (neat): 638, 698, 741, 804, 854, 878, 907, 939, 964, 1005, 1026, 1042, 1069, 1105, 1201, 1244, 1313, 1393, 1454, 2924, 2953, 3412. HR-MS:  $[\text{M}+\text{Na}]^+$  Calculated for  $\text{C}_{14}\text{H}_{18}\text{O}_5$ : 289.10464; found: 289.10500.

## Reactivity of Gulose and Guluronic acid Building blocks

Compound **48**, as described for the synthesis of **13** using **7**. The **48** was obtained (158 mg, 91%). TLC:  $R_f = 0.37$

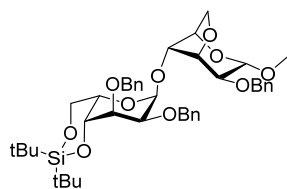

(Pentane/EtOAc, 1/1, v/v).  $[\alpha]_D^{20} = -51^\circ$  (c = 1, CHCl<sub>3</sub>). <sup>1</sup>H NMR (CDCl<sub>3</sub>, 400 MHz, HH-COSY, HSQC):  $\delta$  7.50 – 7.04 (m, 15H), 5.19 (d,  $J = 3.9$  Hz, 1H, H-1<sub>Gul</sub>), 5.00 (d,  $J = 12.2$  Hz, 1H, *CHH* Bn), 4.93 – 4.74 (m, 2H, H-1<sub>Mann</sub>, *CHH* Bn), 4.71 – 4.43 (m, 4H, H-5<sub>Mann</sub>, *CHH* Bn), 4.36 – 3.69 (m, 11H, *CHH* Bn, H-3<sub>Mann</sub>, H-4<sub>Gul</sub>, H-4<sub>Mann</sub>, H-6<sub>Gul</sub>, H-6<sub>Mann</sub>, H-2<sub>Gul</sub>, H-3<sub>Gul</sub>, H-5<sub>Gul</sub>, H-2<sub>Mann</sub>), 3.46 (s, 3H), 1.02 (s, 9H, 3xCH<sub>3</sub> *tert*-Bu), 0.93 (s, 9H, 3xCH<sub>3</sub> *tert*-Bu); <sup>13</sup>C –APT NMR (CDCl<sub>3</sub>, 100 MHz, HSQC):  $\delta$  139.5, 138.6, 138.4(C<sub>q</sub> arom), 128.3, 127.5(CH<sub>arom</sub>), 103.0(C-1<sub>Mann</sub>), 95.8(C-1<sub>Gul</sub>), 76.4(C-3<sub>Mann</sub>), 76.1(C-2<sub>Mann</sub>), 76.0(C-3<sub>Gul</sub>), 74.3(C-4<sub>Mann</sub>), 73.2(C-4<sub>Gul</sub>), 73.1(C-2<sub>Gul</sub>), 73.0, 72.6(CH<sub>2</sub>Bn), 71.8(C-5<sub>Mann</sub>), 71.1(CH<sub>2</sub>Bn), 70.0(C-6<sub>Mann</sub>), 67.1(C-6<sub>Gul</sub>), 64.9(C-5<sub>Gul</sub>), 56.3(OMe), 27.7(CH<sub>3</sub> *tert*-Bu), 27.3(CH<sub>3</sub> *tert*-Bu), 23.4(C<sub>q</sub> *tert*-Bu), 20.5(C<sub>q</sub> *tert*-Bu). IR (neat): 650, 696, 735, 797, 825, 862, 881, 939, 1008, 1028, 1083, 1041, 1074, 1126, 1140, 1204, 1364, 1387, 1454, 1474, 1497, 2856, 2887, 2932. HR-MS: [M+Na<sup>+</sup>] Calculated for C<sub>42</sub>H<sub>56</sub>O<sub>10</sub>Si: 771.35350; found: 771.5294.

Compound **49**, as described of the general procedure for deprotecting of di-*tert*-butyl silylation. The **49** was

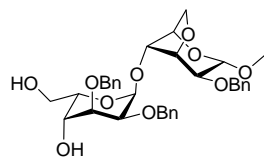

obtained (102 mg, 81%). TLC:  $R_f = 0.18$  (DCM/acetone, 4/1, v/v).  $[\alpha]_D^{20} = -60^\circ$  (c = 1, CHCl<sub>3</sub>). <sup>1</sup>H NMR (CDCl<sub>3</sub>, 400 MHz, HH-COSY, HSQC):  $\delta$  7.46 – 7.04 (m, 15H, CH<sub>arom</sub>), 5.22 (d,  $J = 3.8$  Hz, 1H, H-1<sub>Gul</sub>), 4.99 – 4.69 (m, 4H, H-1<sub>Mann</sub>, *CHH* Bn), 4.72 – 4.42 (m, 4H, H-5<sub>Mann</sub>, *CHH* Bn), 4.42 – 3.55 (m, 14H), 3.46 (s, 3H, OMe); <sup>13</sup>C –APT NMR (CDCl<sub>3</sub>, 100 MHz, HSQC):  $\delta$  139.2, 138.5(C<sub>q</sub> arom), 128.3, 128.2, 127.9, 127.6, 127.4(CH<sub>arom</sub>), 103.0(C-1<sub>Mann</sub>), 96.0(C-1<sub>Gul</sub>), 76.3(C-3<sub>Gul</sub>), 76.0(C-2<sub>Mann</sub>), 76.0(C-3<sub>Mann</sub>), 74.5(C-4<sub>Mann</sub>), 73.6(C-2<sub>Gul</sub>), 72.9(CH<sub>2</sub>Bn), 72.6(CH<sub>2</sub>Bn), 71.8(C-5<sub>Mann</sub>), 71.8(C-4<sub>Gul</sub>), 71.4(CH<sub>2</sub>Bn), 70.0(C-6<sub>Mann</sub>), 66.7(C-5<sub>Gul</sub>), 64.0(C-6<sub>Gul</sub>), 56.4(OMe). IR (neat): 698, 735, 881, 908, 941, 968, 1026, 1070, 1117, 1206, 1454, 2926, 3420. HR-MS: [M+Na<sup>+</sup>] Calculated for C<sub>34</sub>H<sub>40</sub>O<sub>10</sub>: 631.25137; found: 631.25042.

Disaccharide acceptor **21**, As described in the general procedure for oxidation and subsequent methylation. The

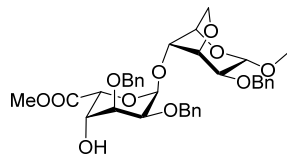

disaccharide acceptor **21** was obtained (92 mg, 90%). TLC:  $R_f = 0.57$  (DCM/acetone, 5/1, v/v).  $[\alpha]_D^{20} = -55^\circ$  (c = 0.8, CHCl<sub>3</sub>). <sup>1</sup>H NMR (CDCl<sub>3</sub>, 400 MHz, HH-COSY, HSQC):  $\delta$  7.48 – 7.06 (m, 15H, CH<sub>arom</sub>), 5.33 (d,  $J = 3.5$  Hz, 1H, H-1<sub>Gul</sub>), 5.02 – 4.68 (m, 4H, H-1<sub>Mann</sub>, *CHH* Bn, H-5<sub>Gul</sub>), 4.66 – 4.45 (m, 4H, H-5<sub>Mann</sub>, *CHH* Bn), 4.37 (d,  $J = 11.9$  Hz, 1H, *CHH* Bn), 4.32 – 4.22 (m, 3H, H-3<sub>Mann</sub>, H-4<sub>Gul</sub>, H-4<sub>Mann</sub>), 4.12 (d,  $J = 10.5$  Hz, 1H, H-6<sub>Mann</sub>), 4.04 – 3.83 (m, 3H, H-6<sub>Mann</sub>, H-2<sub>Gul</sub>, H-3<sub>Gul</sub>), 3.77 (s, 4H, H-2<sub>Mann</sub>, -OCH<sub>3</sub>), 3.47 (s, 3H, -COOCH<sub>3</sub>); <sup>13</sup>C –APT NMR (CDCl<sub>3</sub>, 100 MHz, HSQC):  $\delta$  170.4(-COOCH<sub>3</sub>), 138.8, 138.5, 138.3(C<sub>q</sub> arom), 128.4, 128.3(CH<sub>arom</sub>), 103.0(C-1<sub>Mann</sub>), 96.0(C-1<sub>Gul</sub>), 76.2(C-2<sub>Mann</sub>), 76.1(C-3<sub>Mann</sub>), 75.8(C-3<sub>Gul</sub>), 74.7(C-4<sub>Mann</sub>), 73.1(C-2<sub>Gul</sub>), 72.9, 72.7, 71.9(CH<sub>2</sub>Bn), 71.7(C-5<sub>Mann</sub>), 70.0(C-4<sub>Gul</sub>), 70.0(C-6<sub>Mann</sub>), 69.0(C-5<sub>Gul</sub>), 56.5(-OCH<sub>3</sub>), 52.5(-COOCH<sub>3</sub>). IR (neat): 698, 735, 881, 908, 941, 968, 1008, 1026, 1042, 1072, 1119, 1148, 1206, 1310, 1362, 1454, 1497, 1738,

## Chapter 3

1758, 2895, 3468. HR-MS:  $[M+Na]^+$  Calculated for  $C_{35}H_{40}O_{11}$ : 659.24268; found: 659.24554.

### 6-*O*-acetyl-2,3-di-*O*-benzyl-4-*O*-[methyl 2,3-di-*O*-benzyl-4-*O*-levulinoyl- $\beta$ -D-mannouronate]- $\alpha$ -L-gulopyranoside (22):

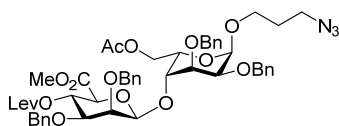

This product was prepared following the general procedure for glycosylation (0.2eq TBSOTf, -78 °C, overnight). Yield: 61 mg, (0.064 mmol), 65%, recovered acceptor **2** 7 mg, 14%. TLC:  $R_f$  = 0.42 (pentane:DCM:ethyl acetate = 2:1:1).  $^1H$  NMR ( $CDCl_3$ , 400 MHz, HH-COSY,

HSQC):  $\delta$  7.47 – 7.13 (m, 20H,  $CH_{arom}$ ), 5.49 (t,  $J$  = 9.7 Hz, 1H, H-4<sub>Mann</sub>), 4.94 (d,  $J$  = 12.2 Hz, 1H,  $CH_2Bn$ ), 4.79 – 4.70 (m, 2H, H-1<sub>Gul</sub>,  $CH_2Bn$ ), 4.69 – 4.59 (m, 2H,  $CH_2Bn$ ), 4.56 – 4.43 (m, 3H,  $CH_2Bn$ ), 4.40 (t,  $J$  = 3.5 Hz, 1H, H-3<sub>Gul</sub>), 4.37 – 4.23 (m, 3H, H-5<sub>Gul</sub>, H-1<sub>Mann</sub>,  $CH_2Bn$ ), 4.16 – 4.01 (m, 2H, H-3<sub>Gul</sub>), 3.90 – 3.66 (m, 7H, H-2<sub>Gul</sub>, H-2<sub>Mann</sub>, H-5<sub>Mann</sub>,  $CH_3OCO-$ ,  $-OCH_2CH_2CH_2N_3$ ), 3.55 – 3.31 (m, 5H, H-4<sub>Gul</sub>, H-3<sub>Mann</sub>,  $-OCH_2CH_2CH_2N_3$ ,  $-OCH_2CH_2CH_2N_3$ ), 2.72 (q,  $J$  = 6.5 Hz, 2H,  $CH_2$  Lev), 2.63 – 2.46 (m, 2H,  $CH_2$  Lev), 2.18 (s, 3H,  $CH_3CO-$ ), 2.04 (s, 3H,  $CH_3CO-$ ), 1.98 (ddd,  $J$  = 13.6, 8.2, 5.3 Hz, 1H,  $-OCH_2CH_2CH_2N_3$ ), 1.87 (tdd,  $J$  = 7.0, 5.5, 2.1 Hz, 1H,  $-OCH_2CH_2CH_2N_3$ );  $^{13}C$  –APT NMR ( $CDCl_3$ , 100 MHz, HSQC):  $\delta$  206.3(C=O Lev), 171.7, 170.8, 167.8(-COO-), 139.4, 138.3, 138.1, 137.7( $C_q$  arom), 128.5, 128.3, 128.3, 128.3, 128.0, 127.9, 127.8, 127.7, 127.6( $CH_{arom}$ ), 103.3(C-1<sub>Mann</sub>), 98.0(C-1<sub>Gul</sub>), 78.2, 78.1(C-3<sub>Mann</sub>, C-4<sub>Gul</sub>), 74.5(C-3<sub>Gul</sub>), 74.0, 73.9( $CH_2Bn$ ), 73.3, 73.0, 72.8(C-2<sub>Mann</sub>, C-5<sub>Mann</sub>, C-2<sub>Gul</sub>), 71.5, 71.2( $CH_2Bn$ ), 68.8(C-4<sub>Mann</sub>), 65.0( $-OCH_2CH_2CH_2N_3$ ), 64.3(C-5<sub>Gul</sub>), 63.4(C-6<sub>Gul</sub>), 52.8(-COO $CH_3$ ), 48.6( $-OCH_2CH_2CH_2N_3$ ), 37.9( $CH_2$  Lev), 30.0( $CH_3CO$ ), 29.1( $-OCH_2CH_2CH_2N_3$ ), 28.0( $CH_2$  Lev), 21.0( $CH_3CO$ ).  $^{13}C$  –HMBC ( $CDCl_3$ , 100 MHz): 103.3( $J_{C1,H1}$  = 157Hz, C-1<sub>Mann</sub>), 98.3( $J_{C1,H1}$  = 168Hz, C-1<sub>Gul</sub>).  $[\alpha]_D^{20}$  = -74° (c = 1.0,  $CHCl_3$ ). IR (neat): 602, 696, 735, 822, 843, 883, 910, 1026, 1044, 1099, 1150, 1175, 1207, 1234, 1362, 1456, 1717, 1742, 2095, 2877, 2918. HR-MS:  $[M+Na]^+$  Calculated for  $C_{51}H_{59}N_3O_{15}$ : 976.38384; found: 976.38532.

### 6-*O*-allyl-2,3-di-*O*-benzyl-4-*O*-[methyl 2,3-di-*O*-benzyl-4-*O*-levulinoyl- $\beta$ -D-mannouronate]- $\alpha$ -L-gulopyranoside (23):

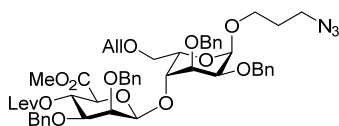

This product was prepared following the general procedure for glycosylation reactions (0.2eq TMSOTf, -78 °C, overnight). Yield: 22 mg, (0.023 mmol), 23% (recovered acceptor 33 mg, 68%). TLC:  $R_f$  = 0.30 (pentane:DCM:ethyl acetate = 3:1:1).  $^1H$  NMR ( $CDCl_3$ , 400 MHz, HH-COSY,

HSQC): 7.45 – 7.16 (m, 20H,  $CH_{arom}$ ), 5.78 (m, 1H, CH All), 5.49 (t,  $J$  = 9.8 Hz, 1H, H-4<sub>Mann</sub>), 5.24 – 5.03 (m, 2H,  $CH_2=CH$  All), 4.90 (d,  $J$  = 12.2 Hz, 1H,  $CH_2Bn$ ), 4.83 – 4.70 (m, 2H, H-1<sub>Gul</sub>,  $CH_2Bn$ ), 4.70 – 4.41 (m, 5H,  $CH_2Bn$ ), 4.41 – 4.20 (m, 4H,  $CH_2Bn$ , H-1<sub>Mann</sub>, H-3<sub>Gul</sub>, H-5<sub>Gul</sub>), 3.95 (m, 1H,  $CH_2$  All), 3.88 – 3.64 (m, 8H,  $CH_2$  All, H-2<sub>Mann</sub>, H-5<sub>Mann</sub>, H-4<sub>Gul</sub>,  $CH_3$  COO $CH_3$ ,  $-OCH_2CH_2CH_2N_3$ ), 3.57 – 3.29 (m, 5H,  $-OCH_2CH_2CH_2N_3$ , H-4<sub>Gul</sub>, H-3<sub>Mann</sub>,  $-OCH_2CH_2CH_2N_3$ ), 2.80 – 2.64 (m, 2H,  $CH_2$  Lev), 2.67 – 2.46 (m, 2H,  $CH_2$  Lev), 2.18 (s, 3H,  $CH_3CO$ ), 2.08 – 1.74 (m, 2H,  $-OCH_2CH_2CH_2N_3$ );  $^{13}C$  –APT NMR ( $CDCl_3$ , 100 MHz, HSQC):  $\delta$  206.4(C=O Lev), 171.7, 167.9(-COO-), 139.4, 138.3, 137.8( $C_q$  arom), 134.5, 128.5, 128.5, 128.4, 128.3, 128.2, 127.9, 127.9, 127.8, 127.7, 127.6, 127.6, 124.9( $CH_{arom}$ ), 117.2( $CH_2=CH$  All), 103.3(C-1<sub>Mann</sub>), 97.9(C-1<sub>Gul</sub>), 78.3(C-3<sub>Mann</sub>), 77.4(C-4<sub>Gul</sub>), 74.5(C-3<sub>Gul</sub>), 73.9, 73.6( $CH_2Bn$ ), 73.4, 73.2, 73.1(C-2<sub>Mann</sub>, C-5<sub>Mann</sub>, C-2<sub>Gul</sub>), 72.2, 71.7, 71.2 ( $CH_2Bn$ ,  $CH_2$  All), 69.0(C-4<sub>Mann</sub>), 68.4(C-6<sub>Gul</sub>), 65.0( $-OCH_2CH_2CH_2N_3$ ), 64.3(C-5<sub>Gul</sub>), 52.8(-

## Reactivity of Gulose and Guluronic acid Building blocks

COOCH<sub>3</sub>), 48.6(-OCH<sub>2</sub>CH<sub>2</sub>CH<sub>2</sub>N<sub>3</sub>), 37.9(CH<sub>2</sub> Lev), 30.0(CH<sub>3</sub>CO), 29.2(-OCH<sub>2</sub>CH<sub>2</sub>CH<sub>2</sub>N<sub>3</sub>), 28.0(CH<sub>2</sub> Lev). [ $\alpha$ ]<sup>20</sup><sub>D</sub> = -59° (c = 0.20, CHCl<sub>3</sub>). HR-MS: [M+Na<sup>+</sup>] Calculated for C<sub>52</sub>H<sub>61</sub>N<sub>3</sub>O<sub>14</sub>: 974.40457; found: 974.40601.

**6-O-(2-cyanoethoxyl methyl)-2,3-di-O-benzyl-4-O-[methyl 2,3-di-O-benzyl-4-O-levulinoyl- $\beta$ -D-mannouronate] - $\alpha$ -L-gulopyranoside (24):** This product was prepared following the general procedure for glycosylation reactions (0.2eq

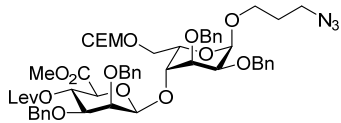

TBSOTf, -78 °C, overnight). Yield: 34 mg, (0.034 mmol), 35% (recovered acceptor 30 mg, 56%). TLC: R<sub>f</sub> = 0.70 (pentane:DCM:ethyl acetate = 1:1:1). <sup>1</sup>H NMR (CDCl<sub>3</sub>, 400 MHz, HH-COSY, HSQC):  $\delta$  7.46 – 7.07 (m, 20H), 5.49 (t, *J* = 9.7 Hz, 1H), 4.91 (d, *J* = 12.2 Hz, 1H), 4.83 – 4.32 (m, 11H), 4.31 – 4.24 (m, 1H), 3.92 – 3.29 (m, 11H), 2.77 – 2.39 (m, 5H), 2.17 (s, 3H), 2.03 – 1.80 (m, 2H); <sup>13</sup>C –APT NMR (CDCl<sub>3</sub>, 100 MHz, HSQC):  $\delta$  206.3, 171.7, 167.8, 139.4, 138.4, 137.9, 128.4, 128.4, 128.4, 128.3, 128.3, 128.2, 128.2, 128.1, 127.9, 127.8, 127.7, 127.7, 127.6, 127.5, 117.9, 103.1, 97.9, 95.6, 78.3, 78.0, 74.4, 73.9, 73.6, 73.3, 73.3, 73.2, 71.7, 71.2, 68.9, 67.4, 65.0, 64.9, 62.5, 52.7, 48.5, 37.9, 30.0, 29.1, 28.0, 19.1. <sup>13</sup>C –HMBC (CDCl<sub>3</sub>, 100 MHz): 103.1(*J*<sub>C1,H1</sub> = 157Hz, C-1<sub>Mann</sub>), 97.9(*J*<sub>C1,H1</sub> = 166Hz, C-1<sub>Gul</sub>). [ $\alpha$ ]<sup>20</sup><sub>D</sub> = -74° (c = 1.0, CHCl<sub>3</sub>). IR (neat): 696, 735, 793, 822, 866, 887, 910, 1026, 1080, 1111, 1152, 1207, 1238, 1263, 1294, 1341, 1362, 1454, 1717, 1748, 2095, 2854, 2924. HR-MS: [M+Na<sup>+</sup>] Calculated for C<sub>53</sub>H<sub>62</sub>N<sub>4</sub>O<sub>15</sub>: 1017.41039; found: 1017.41149.

**Methyl (3-Azidopropyl 2,3-di-O-benzyl-4-O-[methyl 2,3-di-O-benzyl-4-O-levulinoyl- $\beta$ -D-mannopyranosyl uronate]- $\alpha$ -L-gulopyranosyl uronate) (25):** This product was prepared following the general procedure for glycosylation

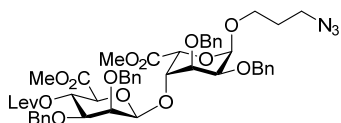

reactions (0.2eq TBSOTf, -78 °C, 1d, -78 °C - -45 °C, 1d). Yield: 52 mg, (0.055 mmol), 55% ( $\beta$ : $\alpha$  = 3:1). TLC: R<sub>f</sub> = 0.63 (toluene:acetone = 3:1). <sup>1</sup>H NMR (CDCl<sub>3</sub>, 400 MHz, HH-COSY, HSQC):  $\delta$  7.43 – 7.12 (m, 20H, CH<sub>arom</sub>), 5.46 (t, *J* = 9.7 Hz, 1H, H-4<sub>Mann</sub>), 4.93 – 4.84 (m, 2H, H-1<sub>Gul</sub>, CH<sub>2</sub>Bn), 4.80

(d, *J* = 1.8 Hz, 1H, H-5<sub>Gul</sub>), 4.75 (d, *J* = 12.4 Hz, 1H, CH<sub>2</sub>Bn), 4.65 – 4.52 (m, 3H, CH<sub>2</sub>Bn), 4.44 (d, *J* = 12.0 Hz, 1H, CH<sub>2</sub>Bn), 4.41 – 4.26 (m, 4H, CH<sub>2</sub>Bn, H-1<sub>Mann</sub>, H-3<sub>Gul</sub>), 4.09 (dd, *J* = 3.8, 1.8 Hz, 1H, H-4<sub>Gul</sub>), 3.83 (t, *J* = 3.6 Hz, 2H, H-2<sub>Gul</sub>, -OCH<sub>2</sub>CH<sub>2</sub>CH<sub>2</sub>N<sub>3</sub>), 3.77 (d, *J* = 9.7 Hz, 1H, H-5<sub>Mann</sub>), 3.71 (6H, 2xCH<sub>3</sub> COOCH<sub>3</sub>), 3.67 (d, *J* = 3.0 Hz, 1H, H-2<sub>Mann</sub>), 3.50 (dt, *J* = 9.9, 5.5 Hz, 1H, -OCH<sub>2</sub>CH<sub>2</sub>CH<sub>2</sub>N<sub>3</sub>), 3.42 – 3.31 (m, 3H, H-3<sub>Mann</sub>, -OCH<sub>2</sub>CH<sub>2</sub>CH<sub>2</sub>N<sub>3</sub>), 2.79 – 2.65 (m, 2H, CH<sub>2</sub> Lev), 2.62 – 2.45 (m, 2H, CH<sub>2</sub> Lev), 2.17 (s, 3H, CH<sub>3</sub>CO), 2.00 – 1.76 (m, 2H, -OCH<sub>2</sub>CH<sub>2</sub>CH<sub>2</sub>N<sub>3</sub>); <sup>13</sup>C –APT NMR (CDCl<sub>3</sub>, 100 MHz, HSQC):  $\delta$  206.3(C=O Lev), 171.7, 170.4, 167.7(-COO-), 139.1, 138.4, 138.0, 137.8v, 128.5, 128.5, 128.4, 128.2, 127.9, 127.7, 127.5(CH<sub>arom</sub>), 103.3(C-1<sub>Mann</sub>), 98.3(C-1<sub>Gul</sub>), 78.7(C-4<sub>Gul</sub>), 78.1(C-3<sub>Mann</sub>), 74.4(C-3<sub>Gul</sub>), 74.2(CH<sub>2</sub>Bn), 73.6(C-2<sub>Mann</sub>), 73.4(C-5<sub>Mann</sub>), 72.8(C-2<sub>Gul</sub>), 71.7, 71.5(CH<sub>2</sub>Bn), 68.9(C-4<sub>Mann</sub>), 67.1(C-5<sub>Gul</sub>), 65.5(-OCH<sub>2</sub>CH<sub>2</sub>CH<sub>2</sub>N<sub>3</sub>), 52.8, 52.5(-COOCH<sub>3</sub>), 48.4(-OCH<sub>2</sub>CH<sub>2</sub>CH<sub>2</sub>N<sub>3</sub>), 37.9(CH<sub>2</sub> Lev), 30.0(CH<sub>3</sub>CO), 29.0(-OCH<sub>2</sub>CH<sub>2</sub>CH<sub>2</sub>N<sub>3</sub>), 28.0(CH<sub>2</sub> Lev); <sup>13</sup>C –HMBC (CDCl<sub>3</sub>, 100 MHz): 103.3(*J*<sub>C1,H1</sub> = 157Hz, C-1<sub>Mann</sub>), 98.3(*J*<sub>C1,H1</sub> = 168Hz, C-1<sub>Gul</sub>). [ $\alpha$ ]<sup>20</sup><sub>D</sub> = -36° (c = 0.88, CHCl<sub>3</sub>). IR (neat): 698, 737, 910, 1026, 1053, 1082, 1092, 1105, 1150, 1177, 1207, 1236, 1304, 1362, 1456, 1717, 1749, 2095, 2852, 2922, 2953. HR-MS: [M+Na<sup>+</sup>] Calculated for C<sub>50</sub>H<sub>57</sub>N<sub>3</sub>O<sub>15</sub>: 962.36819; found: 962.36937.

**3-Azidopropyl 6-O-acetyl-2,3-O-benzyl-4-O-[methyl 2,3-di-O-benzyl-4-O-{methyl 2,3-di-O-benzyl-4-O-levulinoyl- $\alpha$ -L-gulopyranosyl urinate}] $\beta$ -D-mannopyranosyl uronate]- $\alpha$ -L-gulopyranoside (**26**):** This product was prepared following

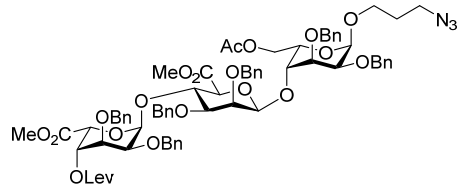

the general procedure for glycosylation reactions (0.2eq TBSOTf, -78 °C, 1d, -78°C - -20 °C, 1d). Yield: 46 mg, (0.035 mmol), 69%. TLC:  $R_f$  = 0.50 (pentane:DCM:ethyl acetate = 3:2:2).  $^1\text{H}$  NMR ( $\text{CDCl}_3$ , 400 MHz, HH-COSY, HSQC):  $\delta$  7.48 – 7.08 (m, 30H,  $\text{CH}_{\text{arom}}$ ), 5.33 (d,  $J$  = 3.9 Hz, 1H, H-1 $_{\text{Gul}}$ ), 5.22

(dd,  $J$  = 3.8, 1.9 Hz, 1H, H-4 $_{\text{Gul}}$ ), 5.17 (d,  $J$  = 1.9 Hz, 1H, H-5 $_{\text{Gul}}$ ), 4.88 (dd,  $J$  = 13.6, 11.9 Hz, 2H,  $\text{CH}_2\text{Bn}$ ), 4.76 – 4.64 (m, 3H, H-1 $_{\text{Gul}}$ ,  $\text{CH}_2\text{Bn}$ ), 4.62 – 4.22 (m, 12H, H-4 $_{\text{Mann}}$ ,  $\text{CH}_2\text{Bn}$ , H-5 $_{\text{Gul}}$ , H-1 $_{\text{Mann}}$ , H-3 $_{\text{Gul}}$ ), 4.06 (m, 2H, H-6 $_{\text{Gul}}$ ), 4.01 (d,  $J$  = 8.5 Hz, 1H, H-5 $_{\text{Mann}}$ ), 3.89 (t,  $J$  = 3.5 Hz, 1H, H-3 $_{\text{Gul}}$ ), 3.84 – 3.74 (m, 3H, H-2 $_{\text{Gul}}$ , H-4 $_{\text{Gul}}$ ,  $-\text{OCH}_2\text{CH}_2\text{CH}_2\text{N}_3$ ), 3.66 (t,  $J$  = 3.7 Hz, 1H, H-2 $_{\text{Gul}}$ ), 3.56 (s, 4H, H-5 $_{\text{Mann}}$ ,  $\text{CH}_3$   $\text{COOCH}_3$ ), 3.47 (dt,  $J$  = 10.4, 5.3 Hz, 1H,  $-\text{OCH}_2\text{CH}_2\text{CH}_2\text{N}_3$ ), 3.44 – 3.35 (m, 6H, H-5 $_{\text{Mann}}$ ,  $\text{CH}_3$   $\text{COOCH}_3$ ,  $-\text{OCH}_2\text{CH}_2\text{CH}_2\text{N}_3$ ), 2.76 – 2.55 (m, 2H,  $\text{CH}_2$  Lev), 2.49 – 2.38 (m, 2H,  $\text{CH}_2$  Lev), 2.15 (s, 3H,  $\text{CH}_3\text{CO}$ ), 2.04 (s, 3H,  $\text{CH}_3\text{CO}$ ), 2.02 – 1.71 (m, 2H,  $-\text{OCH}_2\text{CH}_2\text{CH}_2\text{N}_3$ );  $^{13}\text{C}$  –APT NMR ( $\text{CDCl}_3$ , 100 MHz, HSQC):  $\delta$  206.3(C=O Lev), 171.6, 170.8, 169.0, 168.7(-COO-), 139.4, 138.6, 138.1, 138.0, 137.7, 128.5, 128.4, 128.3, 128.2, 128.1, 128.0, 127.9, 127.8, 127.8, 127.7, 127.7, 127.4, 127.4, 127.4( $\text{CH}_{\text{arom}}$ ), 103.6(C-1 $_{\text{Mann}}$ ), 97.8(C-1 $_{\text{Gul}}$ ), 96.7(C-1 $_{\text{Gul}}$ ), 79.6(C-3 $_{\text{Mann}}$ ), 77.8(C-2 $_{\text{Mann}}$ ), 76.1(C-5 $_{\text{Mann}}$ ), 75.1(C-3 $_{\text{Gul}}$ ), 74.0, 73.9( $\text{CH}_2\text{Bn}$ ), 73.4, 73.1, 73.0(C-2 $_{\text{Mann}}$ , C-4 $_{\text{Gul}}$ , C-2 $_{\text{Gul}}$ ), 73.0( $\text{CH}_2\text{Bn}$ ), 72.5, 72.3(C-3 $_{\text{Gul}}$ , C-2 $_{\text{Gul}}$ ), 71.3, 71.1( $\text{CH}_2\text{Bn}$ ), 71.0(C-4 $_{\text{Gul}}$ ), 66.3(C-5 $_{\text{Gul}}$ ), 64.9( $-\text{OCH}_2\text{CH}_2\text{CH}_2\text{N}_3$ ), 64.2(C-5 $_{\text{Gul}}$ ), 63.3(C-6 $_{\text{Gul}}$ ), 52.4, 52.2(- $\text{COOCH}_3$ ), 48.6( $-\text{OCH}_2\text{CH}_2\text{CH}_2\text{N}_3$ ), 38.0( $\text{CH}_2$  Lev), 29.8( $\text{CH}_3\text{CO}$ ), 29.1( $-\text{OCH}_2\text{CH}_2\text{CH}_2\text{N}_3$ ), 28.1( $\text{CH}_2$  Lev), 21.0( $\text{CH}_3\text{CO}$ );  $^{13}\text{C}$  -HMBCipvGATED ( $\text{CDCl}_3$ , 100 MHz): 103.6( $J_{\text{C1,H1}} = 157\text{Hz}$ , C-1 $_{\text{Mann}}$ ), 97.8( $J_{\text{C1,H1}} = 168\text{Hz}$ , C-1 $_{\text{Gul}}$ ), 96.7( $J_{\text{C1,H1}} = 170\text{Hz}$ , C-1 $_{\text{Gul}}$ ).  $[\alpha]_{\text{D}}^{20} = -83^\circ$  ( $c = 0.84$ ,  $\text{CHCl}_3$ ). IR (neat): 601, 675, 698, 737, 824, 847, 912, 1026, 1092, 1119, 1140, 1177, 1207, 1236, 1304, 1364, 1402, 1437, 1454, 1497, 1719, 1742, 2095, 2916, 3030. HR-MS:  $[\text{M}+\text{Na}^+]$  Calculated for  $\text{C}_{72}\text{H}_{81}\text{N}_3\text{O}_{21}$ : 1346.52528; found: 1346.52759.

**Methyl (3-Azidopropyl 2,3-di-O-benzyl-4-O-[methyl 2,3-di-O-benzyl-4-O-{methyl 2,3-di-O-benzyl-4-levulinoyl- $\alpha$ -L-gulopyranosyl urinate}] $\beta$ -D-mannopyranosyl uronate)- $\alpha$ -L-gulopyranosyl uronate (**27**):** The disaccharide imidate

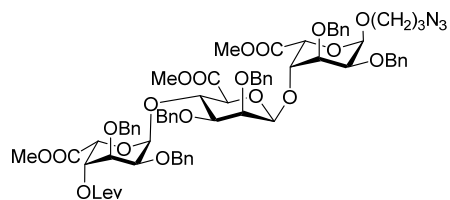

donor **18** (103 mg, 0.1 mmol) and acceptor **6** (24 mg, 0.05mmol) were together co-evaporated with toluene (three times). The residue was dissolved in dry DCM (1 ml). The solution was cooled to -78 °C and followed by adding TBSOTf (5  $\mu\text{l}$ , 0.022 mmol) and the reaction was allowed to stir for 1 day at -78 °C and then -78°C to -30 °C for 12 h. The

reaction was quenched with  $\text{Et}_3\text{N}$  and diluted with EtOAc, washed with sat. aq. NaCl, the organic phase was dried over  $\text{Na}_2\text{SO}_4$  and concentrated in vacuo. Purification by column chromatography (silica gel, pentane/DCM/EtOAc, 3/1/1, v/v/v) yielded **27** as a colourless syrup (55 mg, 84%). TLC:  $R_f$  = 0.42 (pentane/DCM/EtOAc, 2/1/1, v/v/v);  $[\alpha]_{\text{D}}^{20} = -82^\circ$  ( $c = 1$ ,  $\text{CHCl}_3$ ).  $^1\text{H}$  NMR ( $\text{CDCl}_3$ , 400 MHz, HH-COSY, HSQC):  $\delta$  7.49 – 7.00 (m, 30H,  $\text{CH}_{\text{arom}}$ ), 5.31 (d,  $J$  =



## Reactivity of Gulose and Gulosonic acid Building blocks

3.9 Hz, 1H, H-1<sub>Gul'</sub>), 5.24 (dd,  $J = 3.7$ , 1.8 Hz, 1H, H-4<sub>Gul'</sub>), 5.20 (d,  $J = 1.9$  Hz, 1H, H-5<sub>Gul'</sub>), 4.91 – 4.80 (m, 3H, H-1<sub>Gul</sub>, CH<sub>2</sub>Bn), 4.76 (d,  $J = 1.8$  Hz, 1H, H-5<sub>Gul</sub>), 4.73 (s, 1H, CH<sub>2</sub>Bn), 4.70 (d,  $J = 1.4$  Hz, 1H, CH<sub>2</sub>Bn), 4.65 – 4.48 (m, 5H, H-4<sub>Mann</sub>, 2xCH<sub>2</sub>Bn), 4.46 – 4.32 (m, 3H, H-1<sub>Mann</sub>, CH<sub>2</sub>Bn), 4.34 – 4.21 (m, 2H, H-3<sub>Gul</sub>, CH<sub>2</sub>Bn), 4.13 (dd,  $J = 3.8$ , 1.8 Hz, 1H, H-4<sub>Gul</sub>), 4.01 (d,  $J = 8.4$  Hz, 1H, H-5<sub>Mann</sub>), 3.89 (t,  $J = 3.6$  Hz, 1H, H-3<sub>Gul'</sub>), 3.81 (m, 2H, H-2<sub>Gul</sub>, -OCH<sub>2</sub>CH<sub>2</sub>CH<sub>2</sub>N<sub>3</sub>), 3.68 (m, 4H, H-2<sub>Gul'</sub>, CH<sub>3</sub> COOCH<sub>3</sub>), 3.59 (d,  $J = 3.4$  Hz, 1H, H-2<sub>Mann</sub>), 3.54 (s, 3H, CH<sub>3</sub> COOCH<sub>3</sub>), 3.46 (m, 4H, -OCH<sub>2</sub>CH<sub>2</sub>CH<sub>2</sub>N<sub>3</sub>, CH<sub>3</sub> COOCH<sub>3</sub>), 3.35 (t,  $J = 6.7$  Hz, 1H, H-3<sub>Mann</sub>), 2.66 (m, 2H, CH<sub>2</sub> Lev), 2.50 – 2.36 (m, 2H, CH<sub>2</sub> Lev), 2.15 (s, 3H, COCH<sub>3</sub>), 1.98 – 1.70 (m, 2H, -OCH<sub>2</sub>CH<sub>2</sub>CH<sub>2</sub>N<sub>3</sub>). <sup>13</sup>C-APT NMR (CDCl<sub>3</sub>, 100 MHz, HSQC): δ 206.3(-CO-Lev), 171.6, 170.3, 169.1, 168.6(-COO-), 139.0, 138.7, 138.6, 138.1, 138.0, 137.7(C<sub>q</sub> arom), 128.4, 128.3, 128.3, 128.3, 128.1, 128.0, 127.9, 127.8, 127.8, 127.8, 127.7, 127.7, 127.7, 127.5(CH<sub>arom</sub>), 103.4(C-1<sub>Mann</sub>), 98.2(C-1<sub>Gul</sub>), 96.7(C-1<sub>Gul'</sub>), 79.3(C-3<sub>Mann</sub>), 78.3(C-4<sub>Gul</sub>), 76.2(C-5<sub>Mann</sub>), 74.9(C-3<sub>Gul</sub>), 74.2(CH<sub>2</sub>Bn), 74.2(C-2<sub>Mann</sub>), 73.5(CH<sub>2</sub>Bn), 73.2(C-4<sub>Mann</sub>), 73.0(CH<sub>2</sub>Bn), 72.8, 72.6, 72.4(C-2<sub>Gul</sub>, C-2<sub>Gul'</sub>, C-3<sub>Gul'</sub>), 71.5, 71.3, 71.2(CH<sub>2</sub>Bn), 71.0(C-4<sub>Gul'</sub>), 67.1(C-5<sub>Gul</sub>), 66.3(C-5<sub>Gul'</sub>), 65.4(-OCH<sub>2</sub>CH<sub>2</sub>CH<sub>2</sub>N<sub>3</sub>), 52.4, 52.4, 52.2(-COOCH<sub>3</sub>), 48.4(-OCH<sub>2</sub>CH<sub>2</sub>CH<sub>2</sub>N<sub>3</sub>), 37.9(CH<sub>2</sub> Lev), 29.8(COOCH<sub>3</sub>), 29.0(-OCH<sub>2</sub>CH<sub>2</sub>CH<sub>2</sub>N<sub>3</sub>), 28.1(CH<sub>2</sub> Lev); <sup>13</sup>C -HMBCipvGATED (CDCl<sub>3</sub>, 100 MHz): 103.4( $J_{C1,H1} = 157$ Hz, C-1<sub>Mann</sub>), 98.2( $J_{C1,H1} = 168$ Hz, C-1<sub>Gul</sub>), 96.7( $J_{C1,H1} = 171$ Hz, C-1<sub>Gul'</sub>). HR-MS: [M+H]<sup>+</sup> Calculated for C<sub>71</sub>H<sub>79</sub>O<sub>21</sub>N<sub>3</sub>: 1310.52788; found: 1310.55688.

**Tetrasaccharide (28):** This product was prepared following the general procedure for glycosylation reactions (0.2eq

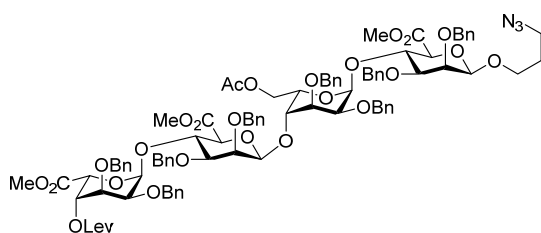

TBSOTf, -78 °C, 1d, -78 °C - -20 °C, 1d). Yield: 28 mg, (0.017 mmol), 33%. TLC:  $R_f = 0.65$  (pentane:DCM:ethyl acetate = 3:2:2). <sup>1</sup>H NMR (CDCl<sub>3</sub>, 400 MHz, HH-COSY, HSQC): δ 7.48 – 7.39 (m, 2H, CH<sub>arom</sub>), 7.39 – 7.08 (m, 38H, CH<sub>arom</sub>), 5.30 (d,  $J = 4.0$  Hz, 1H, H-1<sub>Gul'</sub>), 5.22 (dd,  $J = 3.8$ ,

1.9 Hz, 1H, H-4<sub>Gul'</sub>), 5.18 (d,  $J = 2.0$  Hz, 1H, H-5<sub>Gul'</sub>), 4.99 (d,  $J = 4.0$  Hz, 1H, H-1<sub>Gul</sub>), 4.94 – 4.82 (m, 2H, CH<sub>2</sub>Bn), 4.77 (d,  $J = 12.3$  Hz, 1H, CH<sub>2</sub>Bn), 4.70 (d,  $J = 12.5$  Hz, 2H, CH<sub>2</sub>Bn), 4.62 – 4.37 (m, 12H, H-1<sub>Mann</sub>, CH<sub>2</sub>Bn), 4.33 (s, 2H, CH<sub>2</sub>Bn), 4.28 (t,  $J = 3.6$  Hz, 1H, H-3<sub>Gul</sub>), 4.24 (s, 1H, H-1<sub>Mann'</sub>), 4.13 – 3.94 (m, 4H, -OCH<sub>2</sub>CH<sub>2</sub>CH<sub>2</sub>N<sub>3</sub>, H-6<sub>Gul</sub>, H-5<sub>Mann'</sub>, H-5<sub>Mann'</sub>), 3.95 – 3.84 (m, 2H, H-6<sub>Gul</sub>, H-3<sub>Gul'</sub>), 3.82 – 3.72 (m, 3H, H-3<sub>Mann</sub>, H-2<sub>Gul</sub>, H-2<sub>Mann'</sub>), 3.65 (t,  $J = 3.7$  Hz, 1H, H-2<sub>Gul'</sub>), 3.59 (dd,  $J = 8.3$ , 2.7 Hz, 1H, H-2<sub>Mann</sub>), 3.54 (d,  $J = 1.5$  Hz, 6H, 2xCH<sub>3</sub> COOCH<sub>3</sub>), 3.52 – 3.44 (m, 2H, H-4<sub>Gul</sub>, -OCH<sub>2</sub>CH<sub>2</sub>CH<sub>2</sub>N<sub>3</sub>), 3.42 (s, 3H, CH<sub>3</sub> COOCH<sub>3</sub>), 3.40 – 3.29 (m, 3H, H-3<sub>Mann'</sub>, -OCH<sub>2</sub>CH<sub>2</sub>CH<sub>2</sub>N<sub>3</sub>), 2.75 – 2.56 (m, 2H, CH<sub>2</sub> Lev), 2.48 – 2.38 (m, 2H, CH<sub>2</sub> Lev), 2.15 (s, 3H, CH<sub>3</sub>CO), 1.94 – 1.79 (m, 5H, CH<sub>3</sub>CO, -OCH<sub>2</sub>CH<sub>2</sub>CH<sub>2</sub>N<sub>3</sub>); <sup>13</sup>C-APT NMR (CDCl<sub>3</sub>, 100 MHz, HSQC): δ 206.3(C=O Lev), 171.6, 170.7, 169.3, 169.1, 168.7(-COO-), 139.4, 138.8, 138.7, 138.6, 138.6, 138.2, 138.0, 137.7, 128.5, 128.4, 128.4, 128.3, 128.2, 128.2, 128.0, 127.9, 127.8, 127.8, 127.5, 127.5, 127.4(CH<sub>arom</sub>), 103.6(C-1<sub>Mann'</sub>), 101.2(C-1<sub>Mann</sub>), 96.8, 96.7(C-1<sub>Gul'</sub>, C-1<sub>Gul</sub>), 79.6(C-3<sub>Mann'</sub>), 79.1(C-2<sub>Mann</sub>), 77.8(C-4<sub>Gul</sub>), 76.1(C-5<sub>Mann'</sub>), 75.5(C-5<sub>Mann</sub>), 74.6(C-3<sub>Gul</sub>), 74.4(C-3<sub>Mann</sub>), 74.1, 73.9, 73.7(CH<sub>2</sub>Bn), 73.6, 73.4, 73.2, 73.1, 73.0(CH<sub>2</sub>Bn), 72.5, 72.4, 72.1, 71.3, 71.1, 71.1, 71.0(C-4<sub>Gul'</sub>), 66.7(-OCH<sub>2</sub>CH<sub>2</sub>CH<sub>2</sub>N<sub>3</sub>), 66.3(C-5<sub>Gul'</sub>), 64.2(C-5<sub>Gul</sub>), 62.8(C-6<sub>Gul</sub>), 52.4,

## Chapter 3

52.4, 52.2(-COOCH<sub>3</sub>), 48.5(-OCH<sub>2</sub>CH<sub>2</sub>CH<sub>2</sub>N<sub>3</sub>), 38.0(CH<sub>2</sub> Lev), 29.9(CH<sub>3</sub>CO), 29.2(-OCH<sub>2</sub>CH<sub>2</sub>CH<sub>2</sub>N<sub>3</sub>), 28.1(CH<sub>2</sub> Lev), 21.0(CH<sub>3</sub>CO); <sup>13</sup>C -HMBCipvGATED (CDCl<sub>3</sub>, 100 MHz): 103.6(*J*<sub>C1,H1</sub> = 157Hz, C-1<sub>Mann'</sub>), 101.2(*J*<sub>C1,H1</sub> = 157Hz, C-1<sub>Mann</sub>), 96.8, 96.7(*J*<sub>C1,H1</sub> = 169Hz, C-1<sub>Gul'</sub>, *J*<sub>C1,H1</sub> = 170Hz, C-1<sub>Gul'</sub>). [α]<sub>D</sub><sup>20</sup> = -71° (c = 0.64, CHCl<sub>3</sub>). IR (neat): 698, 737, 910, 1028, 1051, 1098, 1142, 1177, 1206, 1237, 1302, 1362, 1456, 1744, 2097, 2878, 2924. HR-MS: [M+Na<sup>+</sup>] Calculated for C<sub>93</sub>H<sub>103</sub>N<sub>3</sub>O<sub>27</sub>: 1716.66712; found: 1716.66739.

**Methyl (3-Azidopropyl 2,3-di-O-benzyl-4-O-[methyl 2,3-di-O-benzyl-4-O-[methyl 2,3-di-**

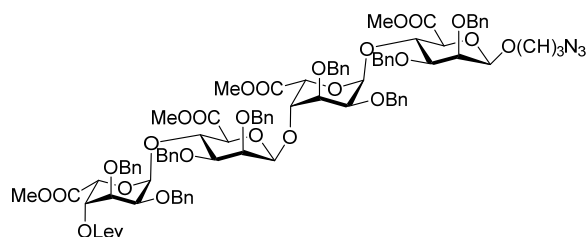

**O-benzyl 4-levulinoyl)-α-L-gulopyranosyl urinate-β-D-mannopyranosyl urinate]-α-L-gulopyranosyl urinate]-β-D-mannopyranosyl uronate) (29):** The disaccharide imidate

donor **18** (154 mg, 0.15 mmol) and acceptor **11** (42 mg, 0.05 mmol) were

together co-evaporated with toluene (three times). The residue was dissolved in dry DCM (0.5 ml). The solution was cooled to -78 °C and followed by adding TBSOTf (7 ul, 0.03 mmol) and the reaction was allowed to stir for 1 day at -78 °C and then -78 °C to -45 °C for 2 days. The reaction was quenched with Et<sub>3</sub>N and diluted with EtOAc, washed with sat. aq. NaCl, the organic phase was dried over Na<sub>2</sub>SO<sub>4</sub> and concentrated in vacuo. Purification by size exclusion and column chromatography (silica gel, pentane/DCM/EtOAc, 3/1/1, v/v/v) yielded product **15** (38 mg, 45%). TLC: R<sub>f</sub> = 0.50 (toluene/acetone, 3/1, v/v); <sup>1</sup>H NMR (CDCl<sub>3</sub>, 400 MHz, HH-COSY, HSQC): δ 7.52 – 6.99 (m, 40H, CH<sub>arom</sub>), 5.28 (d, *J* = 4.0 Hz, 1H, H-1<sub>Gul'</sub>), 5.22 (dd, *J* = 3.7, 1.9 Hz, 1H, H-4<sub>Gul'</sub>), 5.21 – 5.16 (m, 2H, H-1<sub>Gul</sub>, H-5<sub>Gul'</sub>), 5.02 (d, *J* = 1.8 Hz, 1H, H-5<sub>Gul</sub>), 4.87 (d, *J* = 3.4 Hz, 1H, CH<sub>2</sub> Bn), 4.84 (d, *J* = 3.4 Hz, 1H, CH<sub>2</sub> Bn), 4.79 (d, *J* = 12.4 Hz, 1H, CH<sub>2</sub> Bn), 4.75 – 4.17 (m, 18H, 2xH-1<sub>Mann'</sub>, 2xH-4<sub>Mann'</sub>, H-3<sub>Gul</sub>, CH<sub>2</sub> Bn), 4.07 – 4.00 (m, 3H, -OCH<sub>2</sub>CH<sub>2</sub>CH<sub>2</sub>N<sub>3</sub>, H-4<sub>Gul</sub>, H-5<sub>Mann</sub>), 3.97 (d, *J* = 8.4 Hz, 1H, H-5<sub>Mann'</sub>), 3.88 (t, *J* = 3.5 Hz, 1H, H-3<sub>Gul'</sub>), 3.84 – 3.79 (m, 1H, H-2<sub>Mann</sub>), 3.76 (t, *J* = 3.6 Hz, 1H, H-2<sub>Gul</sub>), 3.65 (t, *J* = 3.8 Hz, 1H, H-2<sub>Gul'</sub>), 3.58 – 3.24 (m, 15H, H-2<sub>Mann'</sub>, H-3<sub>Mann'</sub>, H-3<sub>Mann</sub>, -OCH<sub>2</sub>CH<sub>2</sub>CH<sub>2</sub>N<sub>3</sub>, 3xCH<sub>3</sub> COOCH<sub>3</sub>, -OCH<sub>2</sub>CH<sub>2</sub>CH<sub>2</sub>N<sub>3</sub>), 2.66 (dt, *J* = 14.9, 6.1 Hz, 1H, CH<sub>2</sub> Lev), 2.50 – 2.37 (m, 2H, CH<sub>2</sub> Lev), 2.14 (s, 3H, COCH<sub>3</sub>), 1.87-1.70 (m, 2H, -OCH<sub>2</sub>CH<sub>2</sub>CH<sub>2</sub>N<sub>3</sub>); <sup>13</sup>C-APT NMR (CDCl<sub>3</sub>, 100 MHz, HSQC): δ 206.3(C=O Lev), 177.1, 171.6, 170.2, 169.1, 168.8, 168.6(-COO-), 139.3, 138.8, 138.7, 138.6, 138.2, 138.0, 137.7(C<sub>q</sub> arom), 128.4, 128.4, 128.4, 128.3, 128.3, 128.1, 128.1, 128.1, 128.1, 127.9, 127.9, 127.9, 127.8, 127.8, 127.8, 127.8, 127.7, 127.7, 127.7, 127.6, 127.6, 127.5, 127.4, 127.3, 127.2(CH<sub>arom</sub>), 103.3(C-1<sub>Mann'</sub>), 101.5(C-1<sub>Mann</sub>), 97.3(C-1<sub>Gul</sub>), 96.7(C-1<sub>Gul'</sub>), 79.5(C-3<sub>Mann'</sub>), 79.4(C-3<sub>Mann</sub>), 78.5(C-4<sub>Gul</sub>), 76.8(C-5<sub>Mann</sub>), 76.1(C-5<sub>Mann'</sub>), 75.7(C-3<sub>Gul</sub>), 74.4(C-2<sub>Mann'</sub>), 74.3, 73.9(2xCH<sub>2</sub>Bn), 73.8(C-2<sub>Mann</sub>), 73.5(C-4<sub>Mann'</sub>), 73.3, 73.0(2xCH<sub>2</sub>Bn), 73.4, 73.2, 72.5, 72.4(C-2<sub>Gul</sub>, C-4<sub>Mann</sub>, C-2<sub>Gul'</sub>, C-3<sub>Gul'</sub>), 71.3, 71.3, 71.2, 71.1(4xCH<sub>2</sub>Bn), 71.0(C-4<sub>Gul'</sub>), 67.5(C-5<sub>Gul</sub>), 66.8(C-5<sub>Gul'</sub>), 66.3(-OCH<sub>2</sub>CH<sub>2</sub>CH<sub>2</sub>N<sub>3</sub>), 52.4(-COOCH<sub>3</sub>), 52.2(-COOCH<sub>3</sub>), 52.0(-COOCH<sub>3</sub>), 48.5(-OCH<sub>2</sub>CH<sub>2</sub>CH<sub>2</sub>N<sub>3</sub>), 38.0(CH<sub>2</sub> Lev), 29.9(COCH<sub>3</sub>), 29.2(CH<sub>2</sub> Lev), 28.1(-OCH<sub>2</sub>CH<sub>2</sub>CH<sub>2</sub>N<sub>3</sub>); <sup>13</sup>C-HMBCipvGATED (CDCl<sub>3</sub>, 100 MHz): 103.3(*J*<sub>C1,H1</sub> = 157Hz, C-1<sub>Mann'</sub>), 101.5(*J*<sub>C1,H1</sub> = 157Hz, C-1<sub>Mann</sub>), 97.3(*J*<sub>C1,H1</sub> = 170Hz, C-1<sub>Gul</sub>), 96.7(*J*<sub>C1,H1</sub> = 170Hz, C-1<sub>Gul'</sub>). [α]<sub>D</sub><sup>20</sup> = -104° (c = 0.36, CHCl<sub>3</sub>). IR (neat): 698, 739,

## Reactivity of Gulose and Guluronic acid Building blocks

968, 1028, 1038, 1080, 1121, 1209, 1236, 1362, 1456, 1748, 2099, 2853, 2922, 2953. HR-MS:  $[M+Na^+]$  Calculated for  $C_{92}H_{101}O_{27}N_3$ : 1702.65147; found: 1702.65155.

**Methyl (*p*-methoxyphenyl 2,3-di-*O*-benzyl-4-*O*-[6-*O*-acetyl-2,3-di-*O*-benzyl-4-*O*-{ methyl 2,3-di-*O*-benzyl-4-*O*-levulinoyl- $\beta$ -D-mannopyranosyl uronate }- $\alpha$ -L-gulopyranosyl]-1-thio- $\alpha$ -D-mannopyranosyl uronate) (30):** This product was

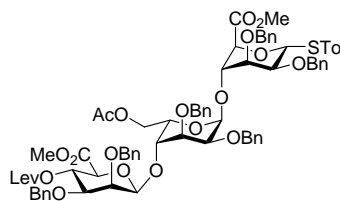

prepared following the general procedure for glycosylation reactions (0.2eq TBSOTf, -78 °C, 1d, -78 °C - -45 °C, 1d). Yield: 51 mg, (0.038 mmol), 77%. TLC:  $R_f$  = 0.55 (pentane:DCM:ethyl acetate = 2:1:1).  $^1H$  NMR ( $CDCl_3$ , 400 MHz, HH-COSY, HSQC):  $\delta$  7.58 – 7.20 (m, 30H,  $CH_{arom}$ ), 7.05 (d,  $J$  = 8.3 Hz, 2H,  $CH_{arom}$ ), 5.70 (d,  $J$  = 8.4 Hz, 1H, H-1<sub>Mann</sub>), 5.50 (t,  $J$  = 9.7 Hz, 1H, H-4<sub>Mann'</sub>), 5.02 (d,  $J$  = 3.9 Hz, 1H, H-1<sub>Gul</sub>), 4.91 (d,  $J$  = 12.0

Hz, 1H,  $CH_2Bn$ ), 4.80 (d,  $J$  = 12.4 Hz, 1H,  $CH_2Bn$ ), 4.69 (d,  $J$  = 12.4 Hz, 1H,  $CH_2Bn$ ), 4.64 – 4.26 (m, 13H, H-5<sub>Mann</sub>, H-4<sub>Mann</sub>,  $CH_2Bn$ , H-1<sub>Mann'</sub>, H-3<sub>Gul</sub>, H-5<sub>Gul</sub>), 4.21 (d,  $J$  = 11.8 Hz, 1H,  $CH_2Bn$ ), 4.13 – 3.73 (m, 7H, H-6<sub>Gul</sub>, H-2<sub>Gul</sub>, H-5<sub>Mann'</sub>, H-2<sub>Mann</sub>, H-3<sub>Mann</sub>, H-2<sub>Mann</sub>), 3.70 (s, 3H,  $CH_3$  COOCH<sub>3</sub>), 3.65 – 3.54 (m, 1H, H-4<sub>Gul</sub>), 3.49 (s, 3H,  $CH_3$  COOCH<sub>3</sub>), 3.43 (dd,  $J$  = 9.7, 2.9 Hz, 1H, H-3<sub>Mann'</sub>), 2.73 (td,  $J$  = 6.5, 3.3 Hz, 2H,  $CH_2$  Lev), 2.61 – 2.47 (m, 2H,  $CH_2$  Lev), 2.26 (s, 3H,  $CH_3$  STol), 2.18 (s, 3H,  $CH_3$ CO), 1.92 (s, 3H,  $CH_3$ CO);  $^{13}C$  –APT NMR ( $CDCl_3$ , 100 MHz, HSQC):  $\delta$  206.4(C=O Lev), 171.7, 170.7, 169.9, 167.7(-COO-), 139.4, 138.4, 138.2, 137.7( $C_q$  arom), 131.6( $CH_{arom}$ ), 130.6( $C_q$  arom), 129.6, 128.5, 128.4, 128.3, 128.3, 128.0, 127.9, 127.9, 127.7, 127.7, 127.6, 127.6( $CH_{arom}$ ), 103.2(C-1<sub>Mann'</sub>), 97.1(C-1<sub>Gul</sub>), 83.0(C-1<sub>Mann</sub>), 78.6(C-4<sub>Gul</sub>), 78.2(C-3<sub>Mann'</sub>), 76.4(C-3<sub>Mann</sub>), 75.3(C-2<sub>Mann</sub>), 74.1( $CH_2Bn$ ), 74.0(C-3<sub>Gul</sub>, C-4<sub>Mann</sub>), 73.9(C-5<sub>Mann</sub>), 73.7( $CH_2Bn$ ), 73.5(C-2<sub>Gul</sub>), 73.4(C-5<sub>Mann'</sub>), 73.2(C-2<sub>Mann'</sub>), 72.8, 72.6, 71.5, 71.2( $CH_2Bn$ ), 68.8(C-4<sub>Mann'</sub>), 64.8(C-5<sub>Gul</sub>), 63.4(C-6<sub>Gul</sub>), 52.8(-COOCH<sub>3</sub>), 52.1(-COOCH<sub>3</sub>), 37.9( $CH_2$  Lev), 30.0( $CH_3$ CO), 28.0( $CH_2$  Lev), 21.2( $CH_3$  STol), 21.0( $CH_3$  Ac).  $[\alpha]_D^{20}$  = -72° (c = 1.0,  $CHCl_3$ ). IR (neat): 601, 696, 733, 810, 864, 893, 910, 951, 1026, 1047, 1072, 1103, 1118, 1152, 1177, 1207, 1236, 1263, 1362, 1454, 1717, 1744, 2855, 2922, 2951. HR-MS:  $[M+Na^+]$  Calculated for  $C_{76}H_{82}O_{20}S$ : 1369.50124; found: 1369.50226.

**Methyl (*p*-methoxyphenyl 2,3-di-*O*-benzyl-4-*O*-[methyl 2,3-di-*O*-benzyl-4-*O*-{ methyl 2,3-di-*O*-benzyl-4-*O*-levulinoyl- $\beta$ -D-mannopyranosyl uronate }- $\alpha$ -L-gulopyranosyl uronate)-1-thio- $\alpha$ -D-mannopyranosyl uronate) (31):** This product was

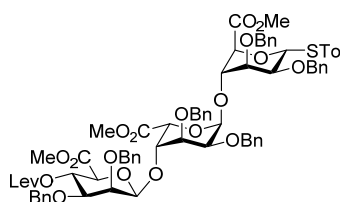

prepared following the general procedure for glycosylation reactions (0.2eq TBSOTf, -78 °C, 3d, -78 °C - -45 °C, 1d). Yield: 59 mg, (0.044 mmol), quantitative yield. TLC:  $R_f$  = 0.70 (pentane:DCM:ethyl acetate = 2:1:1).  $^1H$  NMR ( $CDCl_3$ , 400 MHz, HH-COSY, HSQC):  $\delta$  7.65 – 6.93 (m, 34H,  $CH_{arom}$ ), 5.67 (d,  $J$  = 7.2 Hz, 1H, H-1<sub>Mann</sub>), 5.47 (t,  $J$  = 9.7 Hz, 1H, H-4<sub>Mann'</sub>), 5.17 – 4.99 (m, 1H, H-1<sub>Gul</sub>), 4.90 (d,  $J$  = 12.1 Hz, 1H,  $CH_2Bn$ ), 4.79

(d,  $J$  = 12.4 Hz, 1H,  $CH_2Bn$ ), 4.76(bs, 1H, H-5<sub>Gul</sub>), 4.69 – 4.24 (m, 13H, H-5<sub>Mann</sub>, H-4<sub>Mann</sub>,  $CH_2Bn$ , H-1<sub>Mann'</sub>, H-3<sub>Gul</sub>), 4.20 (d,  $J$  = 10.9 Hz, 1H,  $CH_2Bn$ ), 4.10 (d,  $J$  = 3.2 Hz, 1H, H-4<sub>Gul</sub>), 3.92 – 3.64 (m, 8H, H-2<sub>Gul</sub>, H-5<sub>Mann'</sub>, H-2<sub>Mann</sub>, H-3<sub>Mann</sub>,  $CH_3$

## Chapter 3

COOCH<sub>3</sub>, H-2<sub>Mann'</sub>), 3.59 (s, 3H, CH<sub>3</sub> COOCH<sub>3</sub>), 3.49 (s, 3H, CH<sub>3</sub> COOCH<sub>3</sub>), 3.39 (dd,  $J = 9.8, 3.0$  Hz, 1H, H-3<sub>Mann'</sub>), 2.72 (td,  $J = 6.5, 3.8$  Hz, 2H, CH<sub>2</sub> Lev), 2.66 – 2.43 (m, 2H, CH<sub>2</sub> Lev), 2.27 (s, 3H, CH<sub>3</sub> STol), 2.17 (s, 3H, CH<sub>3</sub>CO); <sup>13</sup>C –APT NMR (CDCl<sub>3</sub>, 100 MHz, HSQC): δ 206.4(C=O Lev), 171.7, 170.1, 169.6, 167.7(-COO-), 139.1, 138.4, 137.9(C<sub>q</sub>arom), 131.9(CH<sub>arom</sub>), 130.4(C<sub>q</sub>arom), 129.6, 128.5, 128.5, 128.4, 128.3, 128.3, 128.2, 128.0, 127.9, 127.9, 127.9, 127.7, 127.6, 127.6, 127.5(CH<sub>arom</sub>), 103.2(C-1<sub>Mann'</sub>), 98.0(C-1<sub>Gul</sub>), 83.1(C-1<sub>Mann</sub>), 79.1(C-4<sub>Gul</sub>), 78.0(C-3<sub>Mann'</sub>), 75.8(C-3<sub>Mann</sub>), 74.9(C-4<sub>Mann</sub>, C-2<sub>Mann</sub>), 74.2(CH<sub>2</sub>Bn), 74.0(C-5<sub>Mann</sub>), 73.8(C-3<sub>Gul</sub>), 73.7(C-2<sub>Mann'</sub>), 73.5(CH<sub>2</sub>Bn), 73.4(C-5<sub>Mann'</sub>), 73.3(C-2<sub>Gul</sub>), 72.5, 72.4, 71.7, 71.4(CH<sub>2</sub>Bn), 68.9(C-4<sub>Mann'</sub>), 67.8(C-5<sub>Gul</sub>), 52.8(-COOCH<sub>3</sub>), 52.2(-COOCH<sub>3</sub>), 52.1(-COOCH<sub>3</sub>), 37.9(CH<sub>2</sub> Lev), 30.0(CH<sub>3</sub>CO), 27.9(CH<sub>2</sub> Lev), 21.2(CH<sub>3</sub> STol). [ $\alpha$ ]<sup>20</sup><sub>D</sub> = -30° (c = 1.0, CHCl<sub>3</sub>). IR (neat): 696, 733, 808, 864, 908, 947, 1026, 1057, 1082, 1105, 1117, 1150, 1177, 1207, 1240, 1265, 1302, 1362, 1456, 1717, 1749, 2853, 2922, 2951. HR-MS: [M+Na<sup>+</sup>] Calculated for C<sub>75</sub>H<sub>80</sub>O<sub>20</sub>S: 1355.48559; found: 1355.48641.

**Tetrasaccharide (32):** This product was prepared following the general procedure for glycosylation reactions (0.6eq

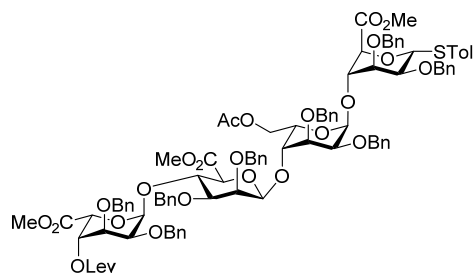

TBSOTf, -78 °C, 1d, -78 °C - -45 °C, 12h). Yield: 69 mg, (0.04 mmol), 80%. TLC: R<sub>f</sub> = 0.52 (toluene:ethyl acetate = 4:3). <sup>1</sup>H NMR (CDCl<sub>3</sub>, 400 MHz, HH-COSY, HSQC): δ 7.53 (d,  $J = 7.8$  Hz, 2H), 7.48 – 7.40 (m, 2H), 7.41 – 7.10 (m, 34H), 7.05 (d,  $J = 8.3$  Hz, 2H), 5.71 (d,  $J = 8.3$  Hz, 1H), 5.32 (d,  $J = 4.0$  Hz, 1H), 5.23 (dd,  $J = 3.6, 1.9$  Hz, 1H), 5.18 (d,  $J = 1.9$  Hz, 1H), 4.98 (d,  $J = 4.0$  Hz, 1H), 4.87 (dd,  $J = 11.9,$

9.2 Hz, 2H), 4.78 – 4.67 (m, 2H), 4.65 – 4.24 (m, 15H), 4.19 (d,  $J = 12.9$  Hz, 1H), 4.10 – 3.92 (m, 3H), 3.93 – 3.74 (m, 5H), 3.66 (dt,  $J = 6.1, 3.6$  Hz, 2H), 3.54 (s, 3H), 3.47 (s, 3H), 3.43 (s, 3H), 2.75 – 2.54 (m, 2H), 2.50 – 2.35 (m, 2H), 2.26 (s, 3H), 2.15 (s, 3H), 1.92 (s, 3H); <sup>13</sup>C –APT NMR (CDCl<sub>3</sub>, 100 MHz, HSQC): δ 206.2, 171.5, 170.6, 169.7, 169.0, 168.6, 139.3, 138.5, 138.3, 138.2, 138.0, 137.9, 137.6, 131.4, 129.5, 128.4, 127.7, 103.4(C-1<sub>Mann'</sub>), 97.0, 96.6(C-1<sub>Gul'</sub>, C-1<sub>Gul'</sub>), 82.8(C-1<sub>Mann</sub>), 79.5, 78.2, 76.0, 75.3, 74.5, 74.2, 74.1, 73.8, 73.8, 73.5, 73.2, 72.9, 72.8, 72.6, 72.4, 72.3, 71.3, 71.1, 70.9, 66.2, 63.2, 52.1, 37.9, 29.7, 28.0, 20.9; <sup>13</sup>C –HMBC (CDCl<sub>3</sub>, 100 MHz): 103.4( $J_{C1,H1} = 157$ Hz, C-1<sub>Mann'</sub>), 82.8(C-1<sub>Mann</sub>), 97.0, 96.6( $J_{C1,H1} = 169$ Hz,  $J_{C1,H1} = 170$ Hz, C-1<sub>Gul'</sub>, C-1<sub>Gul'</sub>). [ $\alpha$ ]<sup>20</sup><sub>D</sub> = -42° (c = 1.0, CHCl<sub>3</sub>). HR-MS: [M+Na<sup>+</sup>] Calculated for C<sub>97</sub>H<sub>104</sub>O<sub>26</sub>S: 1739.64287; found: 1739.64349.

**Tetrasaccharide 33:** As General procedure for glycosylation reactions, purification by column chromatography (silica

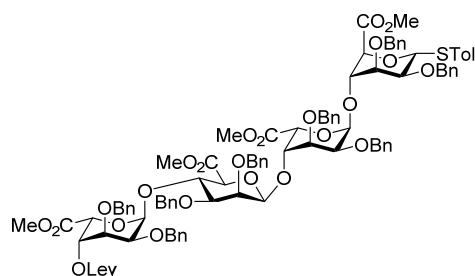

gel, pentane/DCM/EtOAc, 3/1/1, v/v/v) yielded **33** as a colourless form (164 mg, 91%, β:α > 20:1). TLC: R<sub>f</sub> = 0.54 (toluene/EtOAc, 4/3, v/v); [ $\alpha$ ]<sup>20</sup><sub>D</sub> = -61° (c = 1, CHCl<sub>3</sub>). <sup>1</sup>H NMR (CDCl<sub>3</sub>, 400 MHz, HH-COSY, HSQC): δ 7.60 – 6.92 (m, 44H, CH<sub>arom</sub>), 5.68 (d,  $J = 7.8$  Hz, 1H, H-1<sub>Mann</sub>), 5.41 – 5.12 (m, 3H, H-1<sub>Gul'</sub>, H-4<sub>Gul'</sub>, H-5<sub>Gul'</sub>), 5.13 – 4.97 (m, 1H, H-1<sub>Gul</sub>),

## Reactivity of Gulose and Guluronic acid Building blocks

4.98 – 4.20 (m, 19H), 4.23 – 3.98 (m, 2H, H-4<sub>Gul</sub>, H-5<sub>Mann'</sub>), 3.95 – 3.25 (m, 19H), 2.86 – 2.33 (m, 4H, Lev), 2.27 (s, 3H, CH<sub>3</sub> STol), 2.13 (s, 3H, COCH<sub>3</sub>); <sup>13</sup>C –APT NMR (CDCl<sub>3</sub>, 100 MHz, HSQC): δ 206.2(C=O Lev), 171.5, 169.8, 169.5, 169.0, 168.6(-COOCH<sub>3</sub>), 139.0, 138.6, 138.5, 138.1, 138.1, 137.9, 137.8, 137.6(C<sub>q</sub>arom), 131.7(CH<sub>arom</sub>), 130.3(C<sub>q</sub>arom), 129.5, 128.4, 128.4, 128.2, 128.2, 128.1, 128.0, 127.9, 127.8, 127.7, 127.7, 127.6, 127.5, 127.2(CH<sub>arom</sub>), 103.3(C-1<sub>Mann'</sub>), 97.9(C-1<sub>Gul</sub>), 96.6(C-1<sub>Gul'</sub>), 82.5(C-1<sub>Mann'</sub>, the chemical shift of this carbon is according to HSQC because it can not seen from carbon spectrum), 79.3(C-3<sub>Mann'</sub>), 78.6(C-4<sub>Gul</sub>), 77.2(C-5<sub>Mann'</sub>), 76.1, 74.8, 74.3, 74.2, 74.1, 74.0, 73.5, 73.2, 72.9, 72.4, 72.4, 72.3, 72.3, 71.4, 71.2, 71.2, 70.9(C-4<sub>Gul'</sub>), 67.7(C-5<sub>Gul</sub>), 66.2(C-5<sub>Gul'</sub>), 52.3, 52.1, 52.1(-COOCH<sub>3</sub>), 37.8(CH<sub>2</sub> Lev), 29.7(CH<sub>3</sub>CO), 28.0(CH<sub>2</sub> Lev), 21.1(CH<sub>3</sub> STol). IR (neat): 698, 737, 810, 910, 930, 953, 1028, 1063, 1090, 1121, 1177, 1207, 1240, 1285, 1302, 1329, 1362, 1437, 1454, 1497, 1746, 2870, 2922, 3030. HR-MS: [M+Na<sup>+</sup>] Calculated for C<sub>96</sub>H<sub>102</sub>O<sub>26</sub>S: 1725.62722; found: 1725.62820.

**Tetrasaccharide 34:** As General procedure for glycosylation reactions, purification by column chromatography (silica

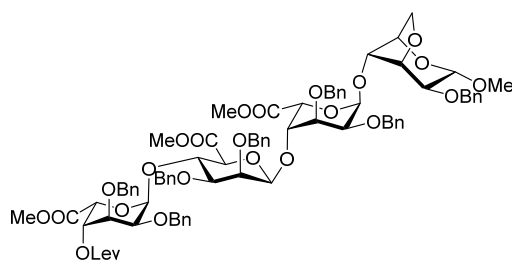

gel, pentane/DCM/EtOAc, 3/1/1, v/v/v) yielded **34**

as a colourless syrup (110 mg, 95%, β:α > 20:1).

TLC: R<sub>f</sub> = 0.20 (toluene/EtOAc, 4/3, v/v); [α]<sup>20</sup><sub>D</sub> = -

71° (c = 1, CHCl<sub>3</sub>). <sup>1</sup>H NMR (CDCl<sub>3</sub>, 400 MHz, HH-

COSY, HSQC): δ 7.54 – 6.98 (m, 35H), 5.32 – 5.14

(m, 6H), 4.91 – 4.80 (m, 4H, H-1<sub>Gul'</sub>, H-1<sub>Gul</sub>, H-4<sub>Gul'</sub>,

H-5<sub>Gul'</sub>), 4.77 (d, J = 1.6 Hz, 2H), 4.69 (d, J = 3.6 Hz,

1H, H-5<sub>Gul</sub>), 4.65 (s, 1H), 4.62 – 4.39 (m, 11H), 4.38 – 4.16 (m, 9H), 4.12 (d, J = 10.5 Hz, 1H), 4.01 (d, J = 8.4 Hz, 1H),

3.92 (m, 4H), 3.74 (dd, J = 6.7, 1.3 Hz, 1H), 3.68 (s, 3H), 3.66 (s, 1H), 3.63 – 3.55 (m, 1H), 3.52 (s, 3H), 3.46 (s, 3H),

3.43 (s, 3H), 3.36 (dd, J = 9.2, 2.6 Hz, 1H), 2.74 – 2.56 (m, 2H), 2.50 – 2.34 (m, 2H), 2.14 (s, 3H). <sup>13</sup>C –APT NMR

(CDCl<sub>3</sub>, 100 MHz, HSQC): δ 206.2, 171.6, 169.9, 169.1, 168.6, 139.3, 138.6, 138.6, 138.6, 138.4, 138.0, 137.7,

128.4, 128.3, 128.3, 128.2, 128.1, 128.0, 127.9, 127.8, 127.7, 127.7, 127.6, 127.5, 127.3, 103.3(C-1<sub>Mann'</sub>), 102.7(C-

1<sub>Mann</sub>), 96.7(C-1<sub>Gul'</sub>), 95.9(C-1<sub>Gul</sub>), 79.3, 78.7, 77.5, 77.2, 76.8, 76.2, 76.0, 74.9, 74.5, 74.2, 74.2, 73.3, 73.3, 73.0,

72.7, 72.5, 72.4, 71.5, 71.3, 71.2, 71.0, 70.1, 67.6(C-5<sub>Gul</sub>), 66.3(C-5<sub>Gul'</sub>), 56.1, 52.4, 52.2, 37.9, 29.8, 28.1; <sup>13</sup>C-

HMBCipvGATED (CDCl<sub>3</sub>, 100 MHz): 103.3(J<sub>C1,H1</sub> = 157Hz, C-1<sub>Mann'</sub>), 102.7(J<sub>C1,H1</sub> = 164Hz, C-1<sub>Mann</sub>), 96.7, 95.9 (J<sub>C1,H1</sub> =

171Hz, 168Hz). IR (neat): 698, 737, 941, 968, 1026, 1070, 1121, 1206, 1238, 1306, 1362, 1437, 1454, 1497, 1744,

2922. HR-MS: [M+Na<sup>+</sup>] Calculated for C<sub>82</sub>H<sub>90</sub>O<sub>25</sub>: 1497.56634; found: 1497.56672.

**Tetrasaccharide 35:** As General procedure for glycosylation reactions, purification by column chromatography (silica

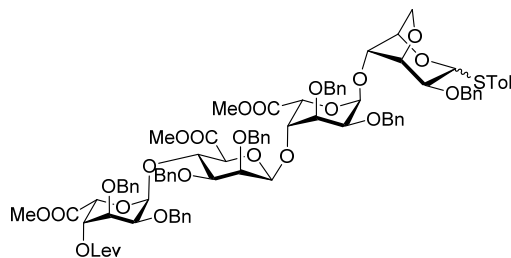

gel, pentane/DCM/EtOAc, 3/1/1, v/v/v) yielded **35**,

the 1-thio-α-D-mannopyranoside was epimerized in

glycosylation condition (α/β = 5/1), as a colourless

syrup (76 mg, 71%, β:α > 20:1). TLC: R<sub>f</sub> = 0.36

## Chapter 3

---

(toluene/EtOAc, 4/3, v/v).  $^1\text{H}$  NMR ( $\text{CDCl}_3$ , 400 MHz, HH-COSY, HSQC):  $\delta$  7.56 – 7.01 (m, 34H), 5.30 (d,  $J$  = 3.9 Hz, 1H), 5.26 – 5.18 (m, 3H), 5.12 (d,  $J$  = 8.9 Hz, 1H), 4.99 (d,  $J$  = 12.2 Hz, 1H), 4.87 (d,  $J$  = 12.0 Hz, 1H), 4.82 – 4.65 (m, 5H), 4.61 – 4.20 (m, 15H), 4.15 – 4.07 (m, 1H), 4.04 (d,  $J$  = 8.3 Hz, 1H), 3.98 – 3.84 (m, 3H), 3.73 (dd,  $J$  = 8.9, 1.3 Hz, 1H), 3.67 (m, 4H), 3.63 – 3.55 (m, 1H), 3.53 (s, 3H), 3.46 (s, 3H), 3.37 (dd,  $J$  = 9.2, 2.8 Hz, 1H), 2.85 – 2.38 (m, 4H), 2.30 (s, 3H), 2.15 (s, 3H);  $^{13}\text{C}$  –APT NMR ( $\text{CDCl}_3$ , 100 MHz, HSQC):  $\delta$  206.2, 171.6, 169.9, 169.1, 168.6, 139.3, 138.6, 138.6, 138.4, 138.2, 138.0, 137.7, 137.2, 131.8, 131.7, 129.7, 128.4, 128.4, 128.3, 128.3, 128.1, 128.0, 128.0, 127.9, 127.8, 127.7, 127.7, 127.7, 127.6, 127.6, 127.5, 127.5, 127.5, 127.4, 127.3, 103.3, 96.7, 96.2, 85.3, 79.4, 78.8, 77.5, 77.2, 76.8, 76.3, 76.3, 75.6, 75.2, 74.5, 74.2, 73.5, 73.3, 73.1, 73.0, 72.7, 72.5, 72.4, 71.5, 71.3, 71.0, 69.7, 67.8, 66.3, 52.4, 52.2, 37.9, 29.8, 28.1, 21.2. IR (neat): 698, 734, 810, 1026, 1061, 1094, 1117, 1207, 1238, 1306, 1360, 1437, 1454, 1495, 1744, 2920, 3030. HR-MS:  $[\text{M}+\text{Na}^+]$  Calculated for  $\text{C}_{88}\text{H}_{94}\text{O}_{24}\text{S}$ : 1589.57480; found: 1589.57607.

## 3.5 References

- [1] a) T. H. Flo, L. Ryan, E. Latz, O. Takeuchi, B. G. Monks, E. Lien, Ø. Halaas, S. Akira, G. Skjåk-Bræk, D. T. Golenbock, T. Espevik, *J. Biol. Chem.*, **2002**, 277, 35489-35495; b) B. H. A. Rehm, S. Valla, *Appl. Microbiol. Biotechnol.*, **1997**, 48, 281-288; c) S. T. Moe, K. I. Draget, G. Sjøk-Bræk, O. Smidsrød, in *Food Polysaccharides and Their Applications*, (Ed: Stephen, A. M.); Marcel Dekker, Inc.; New York, **1995**, pp. 245-286; d) J. Sun, H. Tan, *Materials*, **2013**, 6, 1285-1309.
- [2] M. Hentzer, G. M. Teitzel, G. J. Balzer, A. Heydorn, S. Molin, M. Givskov, M. R. Parsek, *J. Bacteriol.*, **2001**, 183, 5395-5401.
- [3] M. Iwamoto, M. Kurachi, T. Nakashima, D. Kim, K. Yamaguchi, T. Oda, Y. Iwamoto, T. Muramatsu, *FEBS Lett.*, **2005**, 579, 4423-4429.
- [4] a) S. J. Cryz, JR, E. Furer, J. U. Que, *Inf. Immun.*, **1991**, 59, 45-50; b) S. Gallorinia, F. Bertj, G. Mancusob, R. John, L. Telforda, C. Beninatib, D. Maionea, A. Wack, *Proc. Nat. Acad. Sci. USA*, **2009**, 106, 17481-17486.
- [5] a) F. Wolfram, E. N. Kitova, H. Robinson, M. T. C. Walvoort, J. D. C. Codée, J. S. Klassen, P. L. Howell, *J. Biol. Chem.*, **2014**, 289, 6006-6019; b) P. Baker, T. Ricer, P. J. Moynihan, E. N. Kitova, M. T. C. Walvoort, D. Little, J. C. Whitney, K. Dawson, J. T. Weadge, H. Robinson, D. E. Ohman, J. D. C. Codée, J. S. Klassen, A. J. Clarke, P. L. Howell, *PLoS Pathog.*, **2014**, 10, e1004334.
- [6] S. -C. Hung, F. -C. Chi, S. S. Kulkarni, M. M. L. Zulueta, *Chem. Asian J.*, **2009**, 4, 386-390.
- [7] a) L. J. van den Bos, J. Dinkelaar, H. S. Overkleeft, G. A. van der Marel, *J. Am. Chem. Soc.*, **2006**, 128, 13066-13067; b) J. D. C. Codée, L. J. van den Bos, A.R. de Jong, J. Dinkelaar, G. Lodder, H. S. Overkleeft, G. A. van der Marel, *J. Org. Chem.*, **2009**, 74, 38-47; c) M. T. C. Walvoort, G. Lodder, J. Mazurek, H. S. Overkleeft, G. A. van der Marel, J. D. C. Codée, *J. Am. Chem. Soc.*, **2009**, 131,

- 12080-12081; d) M. T. C. Walvoort, H. van den Elst, O. J. Plante, L. Kröck, P. H. Seeberger, H. S. Overkleeft, G. A. van der Marel, J. D. C. Codée, *Angew. Chem. Int. Ed. Engl.*, **2012**, *51*, 4393-4396.
- [8] J. Dinkelaar, L. J. van den Bos, W. F. J. Hogendorf, G. Lodder, H. S. Overkleeft, J. D. C. Codée, G. A. van der Marel, *Chem. Eur. J.*, **2008**, *14*, 9400-9411.
- [9] Q. Zhang, E. R. van Rijssel, M. T. C. Walvoort, H. S. Overkleeft, G. A. van der Marel, and J. D. C. Codée, *Angew. Chem. Int. Ed. Engl.*, **2015**, *54*, 7670-7673.
- [10] J. Dinkelaar, A. R. de Jong, R. van Meer, M. Somers, G. Lodder, H. S. Overkleeft, J. D. C. Codée, G. A. van der Marel, *J. Org. Chem.*, **2009**, *74*, 4982-4991.
- [11] a) M. T. C. Walvoort, J. Dinkelaar, L. J. van den Bos, G. Lodder, H. S. Overkleeft, J. D. C. Codée, G. A. van der Marel, *Carbohydr. Res.*, **2010**, *345*, 1252-1263; b) C. H. Larsen, B. H. Ridgway, J. T. Shaw, K. A. Woerpel, *J. Am. Chem. Soc.*, **1999**, *121*, 12208-12209; c) J. T. Shaw, K. A. Woerpel, *Tetrahedron*, **1999**, *55*, 8747-8756; d) C. H. Larsen, B. H. Ridgway, J. T. Shaw, D. M. Smith, K. A. Woerpel, *J. Am. Chem. Soc.*, **2005**, *127*, 10879-10884; e) C. G. Lucero, K. A. Woerpel, *J. Org. Chem.*, **2006**, *71*, 2641-2647; f) J. A. C. Romero, S. A. Tabacco, K. A. Woerpel, *J. Am. Chem. Soc.*, **2000**, *122*, 168-169
- [12] J. D. C. Codeé, A. E. Christina, M. T. C. Walvoort, H. S. Overkleeft, G. A. van der Marel, *Topics in Current Chemistry, "Reactivity Tuning in Oligosaccharide Assembly"*, Eds.: B. Fraser-Reid, J. Cristóbal-López, **2011**, *301*, 253-289.
- [13] T. Ohgi, Y. Masutomi, K. Ishiyama, H. Kitagawa, Y. Shiba, J. Yano, *Org. Lett.*, **2005**, *7*, 3477-3480.
- [14] a) D. Lee, M. S. Taylor, *J. Am. Chem. Soc.*, **2011**, *133*, 3724-3727; b) D. Lee, C. L. Williamson, L. Chan, M. S. Taylor, *J. Am. Chem. Soc.*, **2012**, *134*, 8260-8267.
- [15] a) S. K. Mulani, W. -C. Hung, A. B. Ingle, K. -S. Shiau, K. -K. Tony Mong, *Org. Biomol. Chem.*, **2014**, *12*, 1184-1197; b) J. Park, S. Kawatkar, J. M. Kim, G. J. Boons, *Org. Lett.*, **2007**, *9*, 1959-1962.
- [16] M. T. C. Walvoort, W. DeWitte, J. Van Dijk, J. Dinkelaar, G. Lodder, J. Mazurek, H. S. Overkleeft, G. A. van der Marel, J. D. C. Codée, *Org. Lett.*, **2011**, *13*, 4360-4363.





# 4

## Acceptor Reactivity in the Total Synthesis of $\alpha$ -L-guluronic acid and $\beta$ -D-mannuronic acid containing Alginate fragments

Partly published in: *Eur. J. Org. Chem*, **2016**, 2393-2397.

*Angew. Chem. Int. Ed*, **2015**, 54, 7670-7673.

### 4.1 introduction

Alginates, naturally occurring anionic polysaccharides, are composed of 1,2-*cis* linked D-mannuronic acid (M) and L-guluronic acid (G, the C-5 epimer of M) residues that are arranged in homopolymer (polymannuronate, -MM-, or polyguluronate -GG-) or heteropolymer -MG- segments<sup>[1]</sup> (Figure 4.1).<sup>[2]</sup> They are found in marine brown algae and various bacteria, including *Pseudomonas aeruginosa*, and have found wide application in the biomaterial and food industry because of their gelling properties.<sup>[3]</sup> Notably, they have also received attention because of their putative anti-tumour, antiviral, antigenic and immunomodulatory activity.<sup>[2,4]</sup> To firmly establish structure-activity relationships for this

class of compounds, well-defined single molecules of a defined length are indispensable.<sup>[5]</sup> In this framework the fully stereoselective assembly of -MM- fragments employing mannuronic acid donor glycosides for the construction of the  $\beta$ -D-mannosidic linkages has previously been reported.<sup>[6]</sup> Using an automated solid phase approach, a set ManA alginate fragments up to the dodecamer level was generated.<sup>[7]</sup> Furthermore, the synthesis of short L-guluronic acid oligomers has also been reported.<sup>[8,9]</sup>

The assembly of mixed alginate sequences, containing both M and G residues has never been achieved and is particularly challenging because it requires the construction of both  $\beta$ -D-mannuronic acid and  $\alpha$ -L-guluronic acid linkages. While D-mannuronic acid donor glycosides can be used for the stereoselective construction of *cis*-glycosidic linkages, L-guluronic acid donors are less stereoselective in glycosylation reactions.<sup>[8,10]</sup> In addition, as described in Chapter 3, the guluronic acid C-4 hydroxyl group is a very poor nucleophile. To circumvent this low reactivity, Hung and co-workers employed 1,6-anhydro-gulose synthons to lock the C4-OH in a more accessible environment and increasing the reactivity of the alcohol.<sup>[9]</sup>

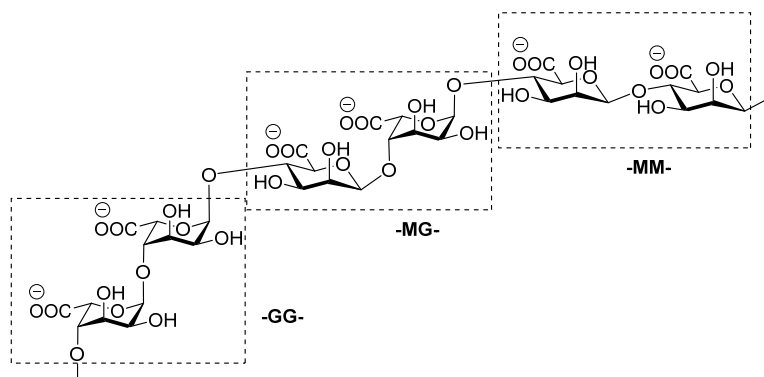

**Figure 4.1** Alginates are composed of -GG-, -MM- and -MG- blocks.

Various approaches can be envisioned for the construction of mixed sequence alginate oligomers, using either monomeric or GM or MG dimer building blocks in a pre-glycosylation oxidation or post-glycosylation oxidation approach.<sup>[11]</sup> Because of the high fidelity of manuronic acid donor synthons in the construction of  $\beta$ -mannosidic linkages an approach using GM building blocks, featuring a manuronic acid donor part, is very attractive. To minimize functional group manipulation at a late stage of the syntheses the use of a guluronic acid acceptor part (as opposed to the use of a gulose acceptor) in the GM building blocks, would be most favorable.<sup>[12]</sup>

In Chapter 3 is presented a first study on the reactivity of gulose and guluronic acid acceptors in glycosylations with manuronic acid donors. It was revealed that the nature of the substituent at the C5 position of these acceptors had relatively little influence on the yield and stereoselectivity of the glycosylations. It was shown however, that the conformational freedom of the acceptors, which in the case of GM-disaccharides is a function of the aglycon at the reducing end, was all-important. The use of disaccharide acceptors featuring a  $\beta$ -mannuronic acid *O*-glycoside at the reducing end provided relatively low yields in condensations with both monomer and dimer glycosyl donors. Contrary, the  $\alpha$ -5-tolyl manuronic acid counterparts could be condensed in high yield and excellent stereoselectivity with the two donor building blocks studied. This Chapter further compares the two types of dimer building blocks in the assembly of mixed sequence alginates.

## 4.2 Results and discussion

The synthesis of disaccharide donor **1**, trisaccharide **2** and tetrasaccharide **3** is described in Chapter 3. Although tetrasaccharide **3** was prepared in low yield, the assembly of longer

oligomers was continued as shown in Scheme 4.1. Delevulinoylation of **2** and **3** gave the GMG and GMGM acceptors **4** and **9**, which were condensed with GM donor **1** to give pentamer GMGMG **5** and hexamer GMGMGM **10** with excellent stereoselectivity but again in a low yield (31% and 30% respectively). The levulinoyl group in pentamer **5** was removed ( $\rightarrow$  **6**) to set the stage for another glycosylation with GM donor **1**, which led to GMGMGMG heptamer **7** in 34% yield. Delevulinoylation of **10** and **7** gave the GMGMGM and GMGMGMG oligosaccharides **11** and **8**, which were then ready for global deprotection, as described in Scheme 4.3. Clearly, the reactivity of all the *O*-linked GM oligosaccharide acceptors was poor leading to constant moderate yields in the glycosylations.

Next, an alternative approach, using thio-disaccharide acceptors, was explored, as it was found that the flexible disaccharide acceptor **15** is an apt nucleophile (see Chapter 3). Building on this finding larger GM oligosaccharides were assembled by hydrolysis of the thioacetal in GMGM tetramer **12** and transforming the resulting hemi-acetal into imidate donor **13** (See Scheme 4.1). Subsequent condensation of donor **13** with guluronic acid acceptor **14** and flexible GM dimer acceptor **15** to give the GMGMG pentamer **5** and the GMGMGM-STol hexamer **16** in 63% and 73% yield, respectively, confirming the good nucleophilicity of acceptor **15**. Elongation of the GMGMGM hexamer **16** with another guluronic acid moiety was accomplished by transformation of thioglycoside **16** into the corresponding imidate **17** and ensuing glycosylation with guluronic acid acceptor **14** to provide GMGMGMG heptamer **7** in 42% yield. The decreased yield in this glycosylation is due to partial hydrolysis of the large hexasaccharide donor.<sup>[17]</sup> It is clear that the approach using the conformational flexible acceptor **15** is overall significantly more effective.

Scheme 4.1 Synthesis of oligosaccharides by using rigid and flexible acceptors.

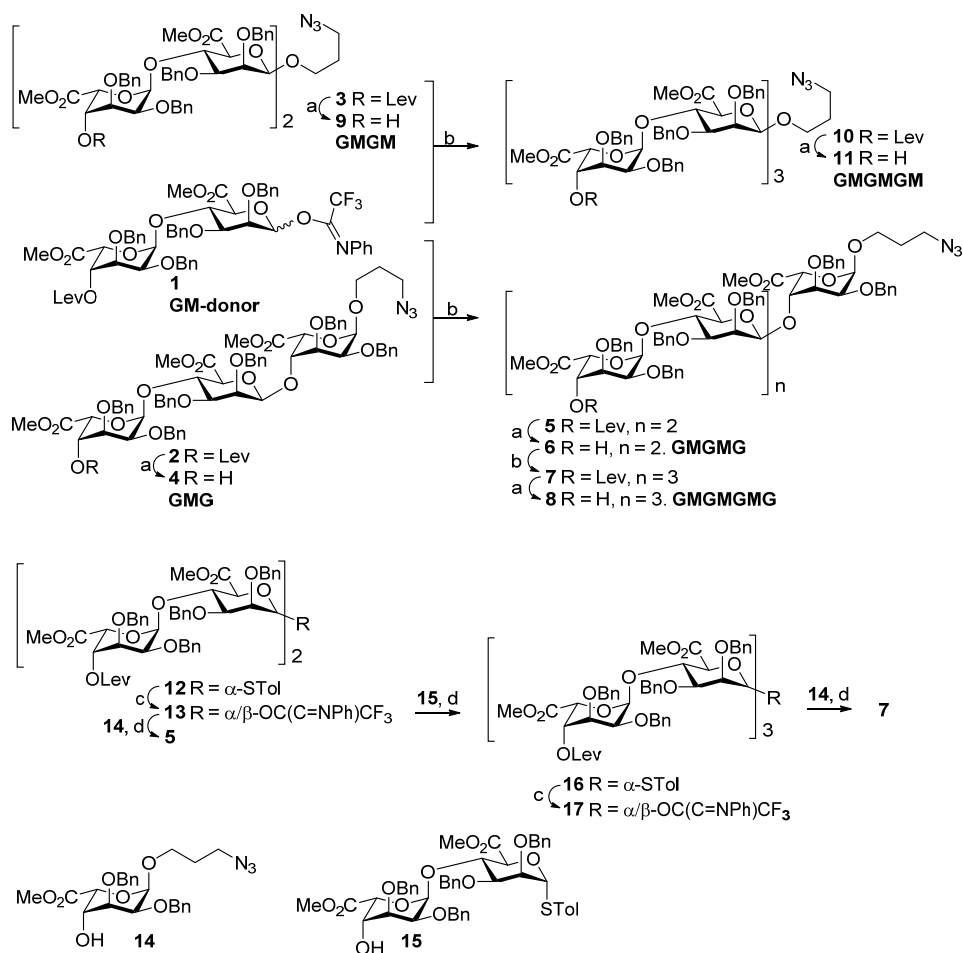

*Reagents and conditions:* (a) N<sub>2</sub>H<sub>4</sub>/H<sub>2</sub>O, acetic acid, pyridine, **4**: 89%; **6**: 98%; **8**: 83%; **9**: 78%; **11**: 86%. (b) TBSOTf (cat.), CH<sub>2</sub>Cl<sub>2</sub>, -78 °C to -45 °C. **5**: 31%; **7**: 34%; **10**: 30%. (c) i. NIS, TFA, CH<sub>2</sub>Cl<sub>2</sub>; ii. F<sub>3</sub>CC(=NPh)Cl, K<sub>2</sub>CO<sub>3</sub>, acetone, **13**: 92%; **17**: 80%. (d) TBSOTf (cat.), CH<sub>2</sub>Cl<sub>2</sub>, -78 °C to -45 °C. **5**: 63%; **7**: 42%; **16**: 73%.

Then a 'random' alginate sequence was generated and GMGGMG hexasaccharide **24** was synthesized using a [2+3+1] approach as depicted in Scheme 4.2. First, trimer **21**, featuring a <sup>1</sup>C<sub>4</sub> chair mannuronic acid residue attached to the acceptor guluronic acid moiety, was generated by condensation of glucose donor **18** with the flexible GM acceptor

**15** to yield trisaccharide **19** in 87% yield and excellent stereoselectivity. Removal of the silylidene group of **19** gave diol **20**, which was oxidized and transformed into the methyl ester to yield **21** in 75% over the three steps. Then **21** was condensed with GM donor **1**.

**Scheme 4.2** synthesis of a 'random' alginate sequence. GMGGMG hexasaccharide.

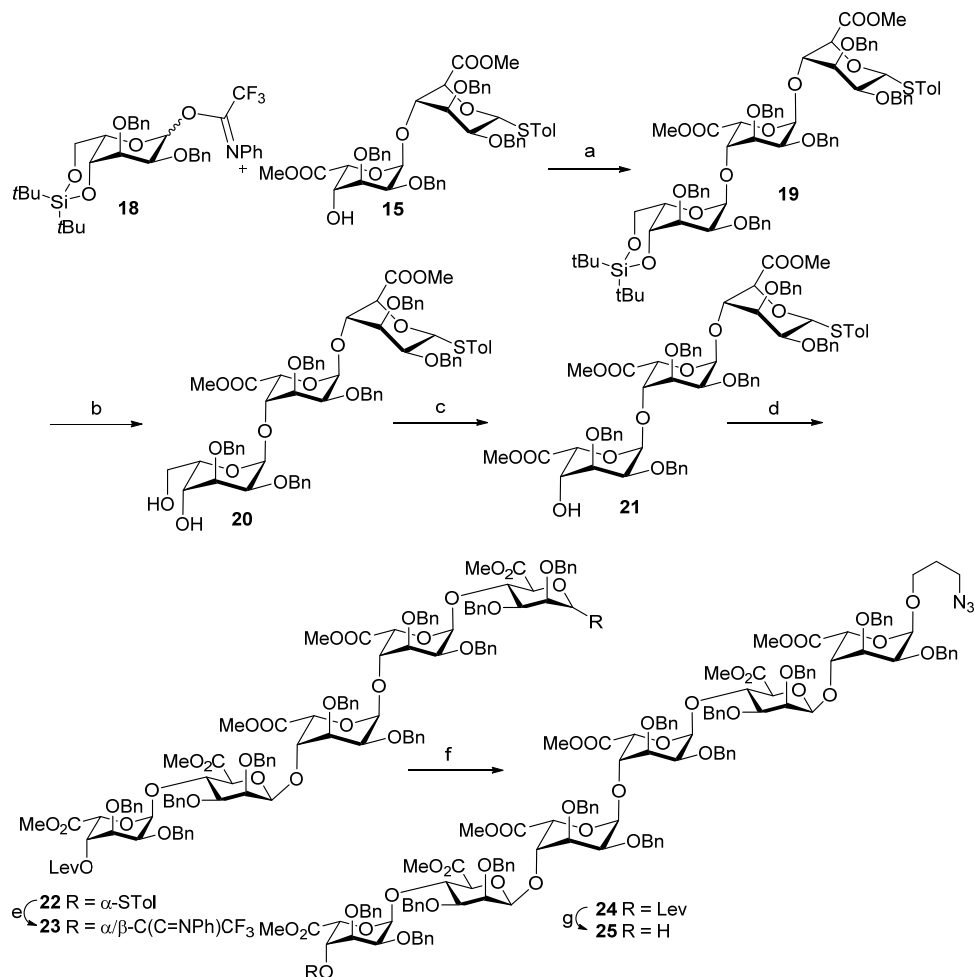

*Reagents and conditions:* (a) TBSOTf (cat.), CH<sub>2</sub>Cl<sub>2</sub>, 0 °C, 92%. (b) HF/Py, pyridine, THF, 0 °C to rt, 2 h, 99%. (c) i. TEMPO, BAIB, *t*BuOH/DCM/H<sub>2</sub>O, ii. MeI, K<sub>2</sub>CO<sub>3</sub>, DMF, 76% (2 steps). (d) **1**, TBSOTf (cat.), CH<sub>2</sub>Cl<sub>2</sub>, -78 °C to -45 °C, 87%. (e) i. NIS, TFA, CH<sub>2</sub>Cl<sub>2</sub>; ii. F<sub>3</sub>CC(=NPh)Cl, K<sub>2</sub>CO<sub>3</sub>, acetone, 82%. (f) TBSOTf (cat.), CH<sub>2</sub>Cl<sub>2</sub>, -78 °C to -45 °C, 43%. (g) N<sub>2</sub>H<sub>4</sub>/H<sub>2</sub>O, acetic acid, pyridine, 87%.

This condensation proceeded uneventfully to provide pentamer GMGGM **22** in 87% yield

This oligosaccharide was transformed into the corresponding imidate donor **23** and then coupled with monosaccharide **14** to give GMGGMG hexamer **24** in 43% yield.<sup>[17]</sup>

Finally, all prepared oligomers were deprotected by i) saponification of the methyl esters, ii) high pressure debenzylation and azide reduction, and finally iii) acetylation of the formed spacer amine group. Purification of the oligomers was accomplished by HW-40 gel size exclusion chromatography, after which the alginate fragments were transformed into the sodium salts (Scheme 4.3).

Scheme 4.3 Deprotection of the oligosaccharides.

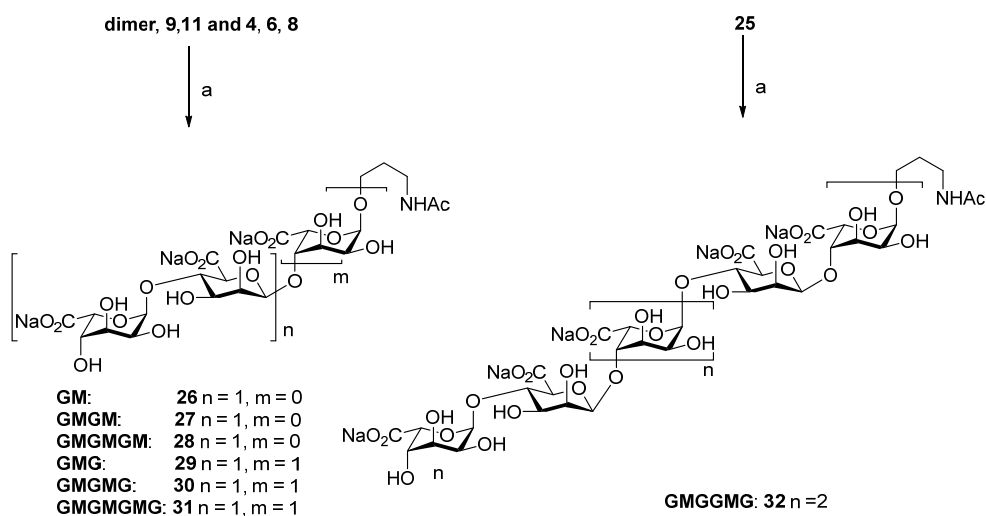

Reagents and conditions: (a) i. LiOH, H<sub>2</sub>O<sub>2</sub>, H<sub>2</sub>O, THF; ii. tBuOH, THF, H<sub>2</sub>O, Pd/C, H<sub>2</sub> (4.5 bar); iii. Ac<sub>2</sub>O, NaHCO<sub>3</sub>, THF, H<sub>2</sub>O; v. Dowex-H<sup>+</sup>. **26**: 46%; **29**: 43%; **27**: 50%; **30**: 25%; **28**: 50%; **31**: 60%; **32**: 60%.

### 4.3 Conclusion

In conclusion, the fully stereoselective assembly of a set of mixed sequence alginate oligomers has been reported for the first time, making these oligosaccharides available for

biochemical studies. A set of alginate fragments, comprised of GM, GMG, GMGM, GMGMG, GMGMGM, GMGMGMG and GMGGMG sequences was assembled. During the assembly of the oligomers the conformational flexibility of the GM acceptors was revealed as an all-important factor determining the efficiency of the coupling reactions. While conformational restriction of carbohydrate building blocks has often been used to develop more efficient glycosylation strategies,<sup>[18]</sup> it is shown here that the use of inflexible building blocks can compromise the yield of a glycosylation reaction. The use of conformationally flexible building blocks can be an effective approach to overcome steric interactions in the crowded transition state of a glycosylation reaction, by allowing the acceptor to adopt a sterically most favourable shape. In future glycosylations, involving poor nucleophiles this can be an important factor to consider when optimizing the reaction.

### 4.4 experimental section

#### General experimental procedures

All reagents were of commercial grade and used as received. All moisture sensitive reactions were performed under an argon atmosphere. DCM used in the glycosylation reactions was distilled over P<sub>2</sub>O<sub>5</sub> and stored on activated 5Å molecular sieves before being used. Reactions were monitored by TLC analysis with detection by UV (254 nm) and where applicable by spraying with 20% sulfuric acid in EtOH or with a solution of (NH<sub>4</sub>)<sub>6</sub>Mo<sub>7</sub>O<sub>24</sub>·4H<sub>2</sub>O (25 g/L) and (NH<sub>4</sub>)<sub>4</sub>Ce(SO<sub>4</sub>)<sub>4</sub>·2H<sub>2</sub>O (10 g/L) in 10% sulfuric acid (aq.) followed by charring at -150 °C. Flash column chromatography was performed on silica gel (40-63µm). <sup>1</sup>H and <sup>13</sup>C spectra were recorded on a Bruker AV 400, Bruker AV 600 or Bruker AV 850 in CDCl<sub>3</sub>, CD<sub>3</sub>OD, CD<sub>3</sub>COCD<sub>3</sub> or D<sub>2</sub>O. Chemical shifts (δ) are given in ppm relative to tetramethylsilane as internal standard (<sup>1</sup>H NMR in CDCl<sub>3</sub>) or the residual signal of the deuterated solvent. Coupling constants (*J*) are given in Hz. All <sup>13</sup>C spectra are proton decoupled. NMR peak assignments were made using COSY and HSQC experiments. Where applicable NOESY, Clean TOCSY, HMBC, HMBC and GATED experiments were used to further elucidate the structure. The anomeric product ratios were analyzed through integration of proton NMR signals.

#### General procedure for hydrolysis of thioglycosidic bond

NIS (5.0 mmol) and TFA (462 µl, 6.0 mmol) were added to a solution of thioglycoside (5.0 mmol) in CH<sub>2</sub>Cl<sub>2</sub> (40 ml)



## Total Synthesis of Alginate fragments

at 0 °C. After analysis by TLC showed complete consumption of the starting material, the reaction was quenched with Et<sub>3</sub>N. Saturated Na<sub>2</sub>S<sub>2</sub>O<sub>3</sub> (aq) was added to the reaction mixture, which was then stirred for 30 min. The aqueous layer was extracted twice with CH<sub>2</sub>Cl<sub>2</sub>, and concentrated *in vacuo*. Purification by column chromatography yielded hydrolyzed product as a colourless oil in good yield.

### General procedure for yield *N*-phenyl-trifluoroacetimidate donor

The starting material (8 mmol) was dissolved in acetone (75 ml) and the solution was cooled to 0 °C. *N*-phenyl-trifluoroacetimidoyl chloride (12 mmol) and cesium carbonate (8 mmol) were added and the resulting suspension was stirred overnight at room temperature. Then Et<sub>3</sub>N was added to the reaction mixture, after which it was filtered and the filtrate was concentrated *in vacuo*. Purification by column chromatography (silica gel, pentane/EtOAc/Et<sub>3</sub>N, 20/1/trace, v/v/trace) yielded *N*-phenyl-trifluoroacetimidate donor in good yield.

### General procedure for the glycosylation reactions

Imidate donor (1.5-3.0 eq) and acceptor (1.0 eq) were co-evaporated with toluene (three times). The residue was dissolved in dry DCM (0.1 M acceptor in DCM). The solution was cooled to -78 °C and followed by adding TBSOTf (0.2-0.6 eq) and the reaction was allowed to stir for 1 day at -78 °C and then slowly warmed to -45 °C and stirred for 2 days. The reaction was quenched with Et<sub>3</sub>N, diluted with EtOAc, washed with sat. aq. NaCl and the organic phase was dried over Na<sub>2</sub>SO<sub>4</sub> and concentrated *in vacuo*. Purification by column chromatography yielded the products.

### General procedure for delevulinoylation

The starting material was dissolved in a mixture of acetic acid and pyridine (1/4, v/v), the mixture was cooled to 0 °C and hydrazine monohydrate (5.0 eq) was added to the solution. The reaction was allowed to stir for 20 min at room temperature. Then the mixture was diluted with EtOAc, washed with 1 N aq. HCl, sat. aq. NaHCO<sub>3</sub> and sat. aq. NaCl. The organic phase was dried over Na<sub>2</sub>SO<sub>4</sub> and concentrated *in vacuo*. Purification by column chromatography yielded the product.

### General procedure for deprotection of the di-*tert*-butyl silylidene

A HF/Pyridine solution (5.0 eq) was added to a solution of starting material in a mixture of THF and pyridine at 0 °C. The reaction was allowed to stir for overnight at room temperature. Then sat. aq. NaHCO<sub>3</sub> was added to neutralize the mixture, which was subsequently, diluted with EtOAc, washed with sat. aq. NaCl. The organic phase was dried over Na<sub>2</sub>SO<sub>4</sub> and concentrated *in vacuo*. Purification by column chromatography yielded the deprotected product.

### General procedure for the oxidation and methyl ester formation

The starting material was dissolved in DCM/*tert*-BuOH/H<sub>2</sub>O (4/4/1, v/v/v). The mixture was cooled to 0 °C and TEMPO (0.2 eq) and BAIB (2.5 eq) were added. After stirring the mixture overnight at 4 °C, Na<sub>2</sub>S<sub>2</sub>O<sub>3</sub> was added and

## Chapter 4

the heterogeneous mixture was stirred for 30 minutes, diluted with EtOAc and washed with sat. aq. NaCl. The organic phase was dried over  $\text{Na}_2\text{SO}_4$  and concentrated *in vacuo*. The crude residue was dissolved in DMF, followed by the addition of  $\text{K}_2\text{CO}_3$  (1.0 eq) and MeI (> 2.0 eq) at  $0^\circ\text{C}$ . The mixture was allowed to stir overnight at  $4^\circ\text{C}$ , and was then diluted with EtOAc and washed with sat. aq. NaCl. The organic phase was dried over  $\text{Na}_2\text{SO}_4$  and concentrated *in vacuo*. Purification by column chromatography (silica gel, pentane/EtOAc, v/v) yielded the methyl ester product.

### General procedure for saponification, hydrogenation and acetylation of the oligosaccharides

The starting material was dissolved in THF (0.4 ml), and a mixture of  $\text{LiOH}\cdot\text{H}_2\text{O}$ /35%  $\text{H}_2\text{O}_2$  solution/ $\text{H}_2\text{O}$  (42 mg/520 ul/480 ul) was added to the reaction mixture. The reaction was allowed to stir for 48h at  $37^\circ\text{C}$ . The reaction was cooled to  $0^\circ\text{C}$  and neutralized by Amberlite IR120 ( $\text{H}^+$ ) resin. After filtration, the filtrate was concentrated *in vacuo*. The residue was dissolved in THF/ $\text{H}_2\text{O}$ /*tert*-BuOH (2 ml/2 ml/0.8 ml) before a catalytic amount of Pd/C was added. The reaction mixture was stirred for 48 h under an  $\text{H}_2$  atmosphere (4.5 bar), filtered and concentrated *in vacuo*. The  $^1\text{H}$  NMR of the thus obtained crude products showed complete removal of all benzyl protecting groups. The resulting product was dissolved in  $\text{H}_2\text{O}$  (1 ml) and THF (0.5 ml), and then  $\text{NaHCO}_3$  (20eq) and  $\text{Ac}_2\text{O}$  (10eq) were added to the reaction mixture, which was stirred overnight at room temperature, after which it was concentrated *in vacuo*. A white powder was obtained, which was purified by gel filtration (HW-40, 0.15M  $\text{NH}_4\text{OAc}$  in  $\text{H}_2\text{O}$ ). The product containing fractions were pooled and lyophilized (4x) to yield the final products as a white solid. The products were transformed into the sodium salts by passing an aqueous solution of the compounds over a short Dowex  $\text{Na}^+$  column, after which the compounds were lyophilized.

### Methyl (3-Azidopropyl 2,3-di-O-benzyl-4-O-[methyl 2,3-di-O-benzyl-4-O-[methyl 2,3-di-O-benzyl- $\alpha$ -L-gulopyranosyl uronate]- $\beta$ -D-mannopyranosyl uronate]- $\alpha$ -L-gulopyranosyl uronate) (4):

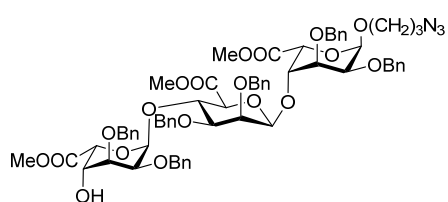

delevulinoylation. Purification by column chromatography (silica gel, pentane/DCM/EtOAc, 2/1/1, v/v) yielded **4** as a colourless oil (230 mg, 96%). TLC:  $R_f = 0.32$  (toluene/EtOAc, 2/1, v/v);  $^1\text{H}$  NMR ( $\text{CDCl}_3$ , 400 MHz, HH-COSY, HSQC):  $\delta$  7.52 – 6.95 (m, 30H,  $\text{CH}_{\text{arom}}$ ), 5.32 (d,  $J = 3.9$  Hz, 1H, H-1 $_{\text{Gul}}$ ), 5.13 (d,  $J = 2.0$  Hz, 1H, H-5 $_{\text{Gul}}$ ), 5.00 – 4.20 (m, 17H, H-1 $_{\text{Gul}}$ , H-

5 $_{\text{Gul}}$ , H-4 $_{\text{Mann}}$ , H-1 $_{\text{Mann}}$ , H-3 $_{\text{Gul}}$ , 6x $\text{CH}_2\text{Bn}$ ), 4.12 (m, 2H, H-4 $_{\text{Gul}}$ , H-4 $_{\text{Gul}}$ ), 4.00 (d,  $J = 8.4$  Hz, 1H, H-5 $_{\text{Mann}}$ ), 3.90-3.75 (m, 4H, H-3 $_{\text{Gul}}$ , H-2 $_{\text{Gul}}$ , H-2 $_{\text{Gul}}$ ,  $-\text{OCH}_2\text{CH}_2\text{CH}_2\text{N}_3$ ), 3.67 (s, 3H,  $\text{CH}_3$  COO $\text{CH}_3$ ), 3.59 (d,  $J = 2.9$  Hz, 1H, H-2 $_{\text{Mann}}$ ), 3.55 – 3.40 (m, 7H,  $-\text{OCH}_2\text{CH}_2\text{CH}_2\text{N}_3$ , 2x $\text{CH}_3$  COO $\text{CH}_3$ ), 3.40 – 3.26 (m, 3H, H-3 $_{\text{Mann}}$ ,  $-\text{OCH}_2\text{CH}_2\text{CH}_2\text{N}_3$ ), 1.99 – 1.66 (m, 2H,  $-\text{OCH}_2\text{CH}_2\text{CH}_2\text{N}_3$ );  $^{13}\text{C}$ -APT NMR ( $\text{CDCl}_3$ , 100 MHz, HSQC):  $\delta$  170.5, 170.2, 168.6(-COO-), 139.0, 138.8, 138.7, 138.1, 138.0, 137.8 ( $\text{C}_q$  arom), 128.5, 128.5, 128.4, 128.4, 128.3, 128.3, 128.2, 128.1, 128.0, 128.0, 127.9, 127.9, 127.8, 127.8, 127.7, 127.7, 127.7, 127.6, 127.6, 127.6, 127.5, 127.5, 127.4, 127.3( $\text{CH}_{\text{arom}}$ ), 103.4(C-1 $_{\text{Mann}}$ ), 98.1(C-1 $_{\text{Gul}}$ ),

## Total Synthesis of Alginate fragments

97.0(C-1<sub>Gul'</sub>), 79.2(C-3<sub>Mann</sub>), 78.2(C-4<sub>Gul</sub>), 76.1(C-5<sub>Mann</sub>), 75.1(C-3<sub>Gul'</sub>), 74.8(C-3<sub>Gul</sub>), 74.2(C-2<sub>Mann</sub>), 74.1, 73.5(CH<sub>2</sub>Bn), 72.9(CH<sub>2</sub>Bn), 72.9, 72.8(C-2<sub>Gul</sub>, C-2<sub>Gul'</sub>, C-4<sub>Mann</sub>), 71.5, 71.5, 71.3(CH<sub>2</sub>Bn), 69.9(C-4<sub>Gul'</sub>), 68.1(C-5<sub>Gul'</sub>), 67.0(C-5<sub>Gul</sub>), 65.3(-OCH<sub>2</sub>CH<sub>2</sub>CH<sub>2</sub>N<sub>3</sub>), 52.3(-COOCH<sub>3</sub>), 52.3(-COOCH<sub>3</sub>), 52.1(-COOCH<sub>3</sub>), 48.3(-OCH<sub>2</sub>CH<sub>2</sub>CH<sub>2</sub>N<sub>3</sub>), 28.9(-OCH<sub>2</sub>CH<sub>2</sub>CH<sub>2</sub>N<sub>3</sub>); <sup>13</sup>C-HMBC (CDCl<sub>3</sub>, 100 MHz): 103.4(*J*<sub>C1,H1</sub> = 157Hz, C-1<sub>Mann</sub>), 98.1(*J*<sub>C1,H1</sub> = 168Hz, C-1<sub>Gul</sub>), 97.0(*J*<sub>C1,H1</sub> = 170Hz, C-1<sub>Gul'</sub>). [ $\alpha$ ]<sup>20</sup><sub>D</sub> = -78° (c = 0.8, CHCl<sub>3</sub>). IR (neat): 696, 735, 908, 1028, 1038, 1065, 1103, 1115, 1177, 1206, 1238, 1304, 1362, 1454, 1749, 2095, 2878. HR-MS: [M+Na<sup>+</sup>] Calculated for C<sub>66</sub>H<sub>73</sub>O<sub>19</sub>N<sub>3</sub>: 1234.47305; found: 1234.47434.

**Pentasaccharide (5):** See General procedure for the glycosylation reactions. Purification by size exclusion and

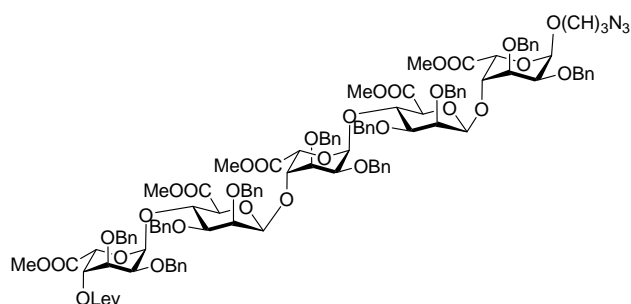

column chromatography (silica gel, pentane/DCM/EtOAc, 5/1/1, v/v) yielded **5** as a colourless syrup (63 mg, 37%,  $\beta$ : $\alpha$  > 20:1). TLC: *R<sub>f</sub>* = 0.56 (toluene/acetone, 3/1, v/v); <sup>1</sup>H NMR (CDCl<sub>3</sub>, 400 MHz, HH-COSY, HSQC):  $\delta$  7.49 – 6.96 (m, 50H, CH<sub>arom</sub>), 5.31 – 5.24 (m, 2H, H-1<sub>Gul'</sub>, H-1<sub>Gul</sub>), 5.23 (dd, *J*

= 3.6, 1.9 Hz, 1H, H-4<sub>Gul'</sub>), 5.19 (d, *J* = 2.0 Hz, 1H, H-5<sub>Gul'</sub>), 4.92 – 4.79 (m, 3H, H-1<sub>Gul</sub>, CH<sub>2</sub> Bn), 4.78 – 4.66 (m, 3H, H-5<sub>Gul</sub>, CH<sub>2</sub> Bn), 4.63 – 4.21 (m, 22H, 2xH-1<sub>Mann</sub>, 2xH-4<sub>Mann</sub>, H-3<sub>Gul</sub>, H-3<sub>Gul'</sub>, 8x CH<sub>2</sub> Bn), 4.15 – 4.09 (m, 1H, H-4<sub>Gul</sub>), 4.06 (dd, *J* = 3.7, 1.8 Hz, 1H, H-4<sub>Gul'</sub>), 3.98 (t, *J* = 8.8 Hz, 2H, 2xH-5<sub>Mann</sub>), 3.88 (t, *J* = 3.5 Hz, 1H, H-3<sub>Gul'</sub>), 3.78 (dt, *J* = 7.9, 2.5 Hz, 3H, -OCH<sub>2</sub>CH<sub>2</sub>CH<sub>2</sub>N<sub>3</sub>, H-2<sub>Gul</sub>, H-2<sub>Gul'</sub>), 3.68 (s, 3H, CH<sub>3</sub> COOCH<sub>3</sub>), 3.65 (d, *J* = 3.8 Hz, 1H, H-2<sub>Gul'</sub>), 3.61 (d, *J* = 2.6 Hz, 1H, H-2<sub>Mann</sub>), 3.57 (d, *J* = 2.9 Hz, 1H, H-2<sub>Mann'</sub>), 3.55 – 3.27 (m, 17H, 2xH-3<sub>Mann</sub>, -OCH<sub>2</sub>CH<sub>2</sub>CH<sub>2</sub>N<sub>3</sub>, 4xCH<sub>3</sub> COOCH<sub>3</sub>, -OCH<sub>2</sub>CH<sub>2</sub>CH<sub>2</sub>N<sub>3</sub>), 2.66 (m, 2H, CH<sub>2</sub> Lev), 2.44 (m, 2H, CH<sub>2</sub> Lev), 2.15 (s, 3H, COCH<sub>3</sub>), 1.98 – 1.73 (m, 2H, -OCH<sub>2</sub>CH<sub>2</sub>CH<sub>2</sub>N<sub>3</sub>); <sup>13</sup>C-APT NMR (CDCl<sub>3</sub>, 100 MHz, HSQC):  $\delta$  206.3(C=O Lev), 171.6, 170.3, 169.1, 168.6, 168.6(-COO-), 139.3, 139.0, 138.8, 138.8, 138.6, 138.2, 138.1, 138.0, 137.8, 137.7(C<sub>q</sub> arom), 128.6, 128.5, 128.5, 128.4, 128.4, 128.3, 128.3, 128.2, 128.1, 128.1, 128.1, 128.1, 128.0, 128.0, 127.9, 127.9, 127.9, 127.8, 127.8, 127.8, 127.7, 127.7, 127.7, 127.6, 127.6, 127.5, 127.5, 127.5, 127.4(CH<sub>arom</sub>), 103.5(C-1<sub>Mann'</sub>), 103.3(C-1<sub>Mann</sub>), 98.2(C-1<sub>Gul</sub>), 97.1(C-1<sub>Gul'</sub>), 96.7(C-1<sub>Gul'</sub>), 79.5, 79.3(2xC-3<sub>Mann</sub>), 78.4, 78.2(C-4<sub>Gul</sub>, C-4<sub>Gul'</sub>), 77.5, 77.2(2xC-5<sub>Mann</sub>), 76.8(C-3<sub>Gul</sub>, C-3<sub>Gul'</sub>), 76.2, 76.1(C-2<sub>Mann</sub>, C-2<sub>Mann'</sub>), 76.0, 75.9, 74.9, 74.4(4xCH<sub>2</sub>Bn), 74.3, 73.6(2xC-4<sub>Mann</sub>), 73.3(CH<sub>2</sub>Bn), 72.8, 72.5, 72.3(C-2<sub>Gul'</sub>, C-2<sub>Gul'</sub>, C-3<sub>Gul'</sub>), 71.5, 71.3, 71.1(3xCH<sub>2</sub>Bn), 71.0(C-4<sub>Gul</sub>), 67.4(C-5<sub>Gul</sub>), 67.1(C-5<sub>Gul</sub>), 66.3(C-5<sub>Gul'</sub>), 65.3(-OCH<sub>2</sub>CH<sub>2</sub>CH<sub>2</sub>N<sub>3</sub>), 52.4, 52.4, 52.3, 52.2, 52.0(5x-COOCH<sub>3</sub>), 48.4(-OCH<sub>2</sub>CH<sub>2</sub>CH<sub>2</sub>N<sub>3</sub>), 37.9(CH<sub>2</sub> Lev), 29.89(COOCH<sub>3</sub>), 29.0(CH<sub>2</sub> Lev), 28.1(-OCH<sub>2</sub>CH<sub>2</sub>CH<sub>2</sub>N<sub>3</sub>). [ $\alpha$ ]<sup>20</sup><sub>D</sub> = -110° (c = 1, CHCl<sub>3</sub>). IR (neat): 696, 733, 841, 908, 961, 1026, 1055, 1092, 1115, 1177, 1206, 1238, 1302, 1362, 1454, 1748, 2097, 2872, 2924. HR-MS: [M+NH<sub>4</sub><sup>+</sup>] Calculated for C<sub>113</sub>H<sub>123</sub>O<sub>33</sub>N<sub>3</sub>: 2067.83770; found: 2067.84914.

## Chapter 4

**Pentasaccharide (6):** See General procedure for delevulinoylation. Purification by column chromatography (silica

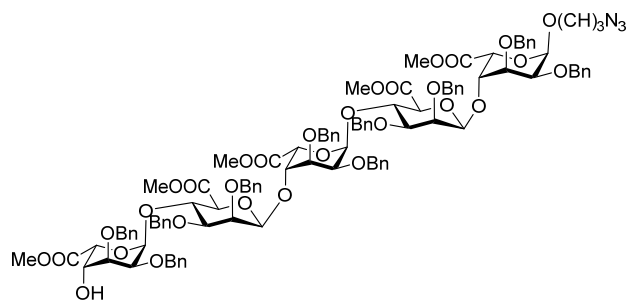

gel, pentane/DCM/EtOAc, 4/3/3, v/v)

yielded **15** as a colourless oil (79 mg,

98%). TLC:  $R_f = 0.29$  (toluene/acetone,

3/1, v/v);  $^1\text{H NMR}$  ( $\text{CDCl}_3$ , 400 MHz, HH-

COSY, HSQC):  $\delta$  7.43 – 7.04 (m, 50H),

5.31 – 5.24 (m, 2H, H-1 $_{\text{Gul}''}$ , H-1 $_{\text{Gul}'}$ ),

5.12 (d,  $J = 1.8$  Hz, 1H, H-5 $_{\text{Gul}''}$ ), 5.08 (d,

$J = 1.8$  Hz, 1H, H-5 $_{\text{Gul}'}$ ), 4.86-4.82 (m,

3H, H-1 $_{\text{Gul}}$ , CH $_2$  Bn), 4.76 (d,  $J = 1.8$  Hz, 1H, H-5 $_{\text{Gul}}$ ), 4.75 – 4.20 (m, 24H, 2xH-1 $_{\text{Mann}}$ , 2xH-4 $_{\text{Mann}}$ , H-3 $_{\text{Gul}}$ , H-3 $_{\text{Gul}'}$ , 9xCH $_2$

Bn), 4.15 – 4.04 (m, 3H, 3xH-4 $_{\text{Gul}}$ ), 3.97 (dd,  $J = 13.5, 8.5$  Hz, 2H, 2xH-5 $_{\text{Mann}}$ ), 3.87 (t,  $J = 3.9$  Hz, 1H, H-3 $_{\text{Gul}''}$ ), 3.78-

3.73(m, 4H, -OCH $_2$ CH $_2$ CH $_2$ N $_3$ , 3xH-2 $_{\text{Gul}}$ ), 3.68 (s, 3H, CH $_3$  COOCH $_3$ ), 3.61 (d,  $J = 3.4$  Hz, 1H, H-2 $_{\text{Mann}}$ ), 3.57 (d,  $J = 3.6$

Hz, 1H, H-2 $_{\text{Mann}}$ ), 3.52 (s, 3H, CH $_3$  COOCH $_3$ ), 3.49 (s, 3H, CH $_3$  COOCH $_3$ ), 3.48-3.46(m, 1H, -OCH $_2$ CH $_2$ CH $_2$ N $_3$ ), 3.45 (s,

3H, CH $_3$  COOCH $_3$ ), 3.39 (s, 3H, CH $_3$  COOCH $_3$ ), 3.37 – 3.29 (m, 4H, 2xH-3 $_{\text{Mann}}$ , -OCH $_2$ CH $_2$ CH $_2$ N $_3$ ), 1.98 – 1.71 (m, 2H, -

OCH $_2$ CH $_2$ CH $_2$ N $_3$ );  $^{13}\text{C}$ -APT NMR ( $\text{CDCl}_3$ , 100 MHz, HSQC):  $\delta$  170.6, 170.3, 170.3, 168.7, 168.6(-COO-), 139.3, 139.1,

138.8, 138.3, 138.2, 138.1, 137.9(C $_{\text{q arom}}$ ), 128.5, 128.5, 128.4, 128.4, 128.4, 128.4, 128.3, 128.3, 128.3, 128.2,

128.2, 128.1, 128.0, 128.0, 128.0, 127.9, 127.9, 127.9, 127.8, 127.8, 127.8, 127.7, 127.6, 127.6, 127.6, 127.5,

127.5, 127.5, 127.4, 127.4, 127.3(CH $_{\text{arom}}$ ), 103.5, 103.3(2xC-1 $_{\text{Mann}}$ ), 98.2(C-1 $_{\text{Gul}}$ ), 97.1, 97.0(C-1 $_{\text{Gul}''}$ , C-1 $_{\text{Gul}'}$ ), 79.5,

79.3(2xC-3 $_{\text{Mann}}$ ), 78.4, 78.2(C-4 $_{\text{Gul}}$ , C-4 $_{\text{Gul}'}$ ), 77.5, 77.2(2xC-5 $_{\text{Mann}}$ ), 76.8, 76.2, 76.1, 75.2, 74.9(3xC-3 $_{\text{Gul}}$ , 2xC-2 $_{\text{Mann}}$ ),

74.4, 74.3, 74.2, 73.6(4xCH $_2$ Bn), 74.2, 73.5(2xC-4 $_{\text{Mann}}$ ), 73.3, 73.0(CH $_2$ Bn), 73.3, 73.1, 72.8(3xC-2 $_{\text{Gul}}$ ), 71.6, 71.5, 71.3,

71.1 (4xCH $_2$ Bn), 70.0(C-4 $_{\text{Gul}''}$ ), 68.1(C-5 $_{\text{Gul}''}$ ), 67.4(C-5 $_{\text{Gul}'}$ ), 67.1(C-5 $_{\text{Gul}}$ ), 65.4(-OCH $_2$ CH $_2$ CH $_2$ N $_3$ ), 52.4, 52.3, 52.3, 52.2,

51.9(5x-COOCH $_3$ ), 48.4(-OCH $_2$ CH $_2$ CH $_2$ N $_3$ ), 29.0(-OCH $_2$ CH $_2$ CH $_2$ N $_3$ );  $^{13}\text{C}$  -HMBC ( $\text{CDCl}_3$ , 100 MHz): 103.5, 103.3( $J_{\text{C1,H1}} =$

157Hz, C-1 $_{\text{Mann}}$ ), 98.2( $J_{\text{C1,H1}} = 169\text{Hz}$ , C-1 $_{\text{Gul}}$ ), 97.1, 97.0( $J_{\text{C1,H1}} = 169\text{Hz}$ , C-1 $_{\text{Gul}''}$ , C-1 $_{\text{Gul}'}$ ).  $[\alpha]_{\text{D}}^{20} = -84^\circ$  (c = 1, CHCl $_3$ ). IR

(neat): 698, 737, 1028, 1038, 1065, 1115, 1207, 1238, 1456, 1749, 2096, 2924. HR-MS:  $[\text{M}+\text{NH}_4]^+$  Calculated for

C $_{108}$ H $_{117}$ O $_{31}$ N $_3$ : 1969.80093; found: 1969.80604.

## Total Synthesis of Alginate fragments

**Heptasaccharide (7):** See General procedure for the glycosylation reactions. Purification by column chromatography

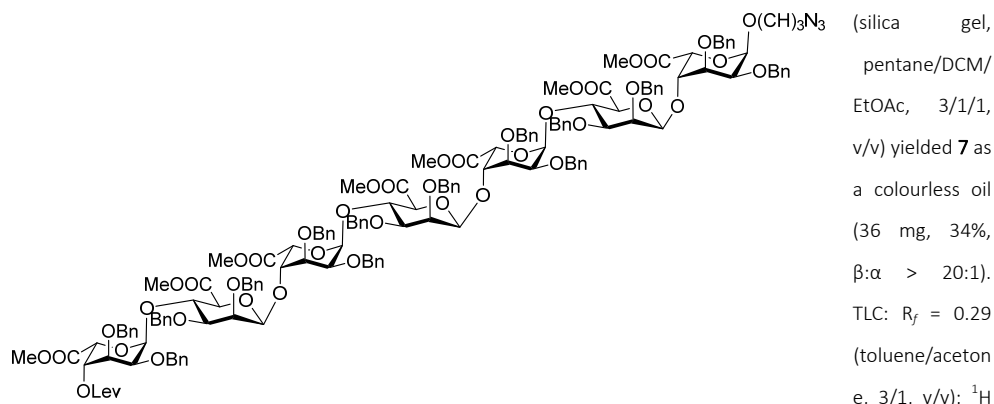

NMR ( $\text{CDCl}_3$ , 400 MHz, HH-COSY, HSQC):  $\delta$  7.50 – 6.95 (m, 70H,  $\text{CH}_{\text{arom}}$ ), 5.31 – 5.20 (m, 4H, H-1 $_{\text{Gal}}^{\text{H}}$ , H-1 $_{\text{Gal}}^{\text{H}}$ , H-1 $_{\text{Gal}}^{\text{H}}$ , H-4 $_{\text{Gal}}^{\text{H}}$ ), 5.19 (d,  $J = 1.8$  Hz, 1H, H-5 $_{\text{Gal}}^{\text{H}}$ ), 5.07 (bs, 2H, H-5 $_{\text{Gal}}^{\text{H}}$ , H-5 $_{\text{Gal}}^{\text{H}}$ ), 4.92 – 4.79 (m, 4H, H-1 $_{\text{Gal}}^{\text{H}}$ ,  $\text{CH}_2$  Bn), 4.75 (s, 1H, H-5 $_{\text{Gal}}^{\text{H}}$ ), 4.71 (dd,  $J = 12.1, 6.0$  Hz, 3H,  $\text{CH}_2$  Bn), 4.60-4.22 (m, 31H, 3xH-4 $_{\text{Mann}}$ , 3xH-1 $_{\text{Mann}}$ , 3xH-3 $_{\text{Gal}}^{\text{H}}$ , 11x  $\text{CH}_2$  Bn), 4.12 (dd,  $J = 5.9, 0.0$  Hz, 1H, H-4 $_{\text{Gal}}^{\text{H}}$ ), 4.05 (d,  $J = 3.4$  Hz, 2H, 2xH-4 $_{\text{Gal}}^{\text{H}}$ ), 4.02 – 3.90 (m, 3H, 3xH-5 $_{\text{Mann}}$ ), 3.88 (t,  $J = 3.5$  Hz, 1H, H-3 $_{\text{Gal}}^{\text{H}}$ ), 3.77 (m, 3H,  $-\text{OCH}_2\text{CH}_2\text{CH}_2\text{N}_3$ , 2xH-2 $_{\text{Gal}}^{\text{H}}$ ), 3.70 – 3.25 (m, 31H, H-2 $_{\text{Gal}}^{\text{H}}$ , 3xH-2 $_{\text{Mann}}$ , 3xH-3 $_{\text{Mann}}$ ,  $-\text{OCH}_2\text{CH}_2\text{CH}_2\text{N}_3$ , 7x $\text{CH}_3$ ,  $\text{COOCH}_3$ ,  $-\text{OCH}_2\text{CH}_2\text{CH}_2\text{N}_3$ ), 2.76 – 2.55 (m, 2H,  $\text{CH}_2$  Lev), 2.42 (ddd,  $J = 10.9, 7.7, 4.5$  Hz, 2H,  $\text{CH}_2$  Lev), 2.14 (s, 3H,  $\text{COCH}_3$ ), 1.96 – 1.75 (m, 2H,  $-\text{OCH}_2\text{CH}_2\text{CH}_2\text{N}_3$ );  $^{13}\text{C}$ -APT NMR ( $\text{CDCl}_3$ , 100 MHz, HSQC):  $\delta$  206.2(C=O Lev), 171.6, 170.3, 169.1, 168.6, 168.6(-COO-), 139.3, 139.1, 138.9, 138.9, 138.8, 138.6, 138.3, 138.1, 138.0, 137.9, 137.9, 137.7( $\text{C}_{\text{q arom}}$ ), 128.6, 128.5, 128.5, 128.4, 128.4, 128.4, 128.3, 128.2, 128.1, 128.1, 128.0, 128.0, 128.0, 127.9, 127.9, 127.8, 127.8, 127.8, 127.8, 127.7, 127.7, 127.7, 127.6, 127.6, 127.5, 127.5, 127.5, 127.4, 127.2( $\text{CH}_{\text{arom}}$ ), 103.5, 103.3(3xC-1 $_{\text{Mann}}$ ), 98.2, 97.2, 97.1, 96.7(4xC-1 $_{\text{Gal}}^{\text{H}}$ ), 79.5, 79.4(3xC-3 $_{\text{Mann}}$ ), 78.4, 78.3(C-4 $_{\text{Gal}}^{\text{H}}$ , C-4 $_{\text{Gal}}^{\text{H}}$ , C-4 $_{\text{Gal}}^{\text{H}}$ ), 76.3, 76.2, 76.2(3xC-5 $_{\text{Mann}}$ ), 74.9, 74.5, 74.3(3xC-3 $_{\text{Gal}}^{\text{H}}$ , 3xC-2 $_{\text{Mann}}$ ), 74.3, 74.2, 73.6, 73.3, 73.0(4x $\text{CH}_2$  Bn), 73.2, 73.1, 72.9, 72.6, 72.4(4xC-2 $_{\text{Gal}}^{\text{H}}$ , C-3 $_{\text{Gal}}^{\text{H}}$ ), 71.6, 71.3, 71.2, 71.2, 71.1(5x $\text{CH}_2$  Bn), 71.0(C-4 $_{\text{Gal}}^{\text{H}}$ ), 67.4, 67.1, 66.3(4xC-5 $_{\text{Gal}}^{\text{H}}$ ), 65.4( $-\text{OCH}_2\text{CH}_2\text{CH}_2\text{N}_3$ ), 52.3, 52.3, 52.3, 52.2, 51.9(7x-COO $\text{CH}_3$ ), 48.4( $-\text{OCH}_2\text{CH}_2\text{CH}_2\text{N}_3$ ), 38.0( $\text{CH}_2$  Lev), 29.8( $\text{COCH}_3$ ), 29.0( $\text{CH}_2$  Lev), 28.1( $-\text{OCH}_2\text{CH}_2\text{CH}_2\text{N}_3$ );  $^{13}\text{C}$ -HMBC ( $\text{CDCl}_3$ , 100 MHz): 103.5, 103.3( $J_{\text{C1,H1}} = 158\text{Hz}$ , 3xC-1 $_{\text{Mann}}$ ), 98.2( $J_{\text{C1,H1}} = 168\text{Hz}$ , C-1 $_{\text{Gal}}^{\text{H}}$ ), 97.2, 97.1, 97.0( $J_{\text{C1,H1}} = 170\text{Hz}$ , C-1 $_{\text{Gal}}^{\text{H}}$ , C-1 $_{\text{Gal}}^{\text{H}}$ , C-1 $_{\text{Gal}}^{\text{H}}$ ).  $[\alpha]_{\text{D}}^{20} = -95^\circ$  (c = 0.88,  $\text{CHCl}_3$ ). IR (neat): 698, 737, 1028, 1038, 1059, 1096, 1117, 1207, 1240, 1362, 1456, 1749, 2098, 2924. HR-MS:  $[\text{M}+\text{Na}^+]$  Calculated for  $\text{C}_{155}\text{H}_{167}\text{O}_{45}\text{N}_3$ : 2813.07618; found: 2813.08957.

## Chapter 4

**heptasaccharide (8):** See General procedure for delevulinoylation. Purification by column chromatography (silica

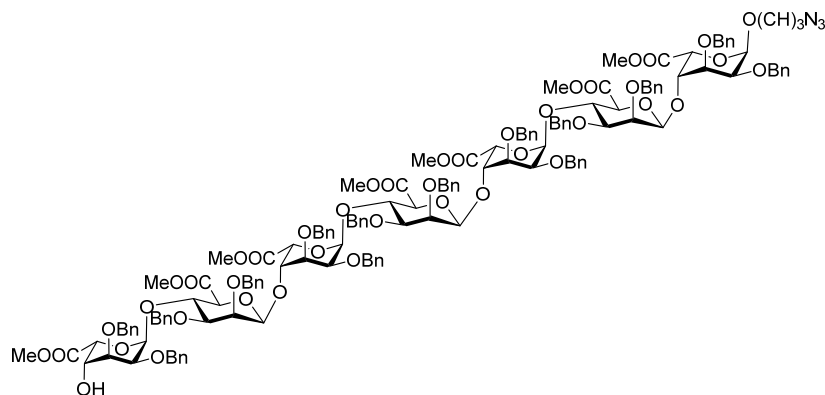

gel, DCM/MeOH, 100/1, v/v) yielded **8** as a colourless oil (45 mg, 83%). TLC:  $R_f = 0.31$  (toluene/acetone, 3/1, v/v);  $^1\text{H}$  NMR ( $\text{CDCl}_3$ ,

400 MHz, HH-COSY, HSQC):  $\delta$  7.49 – 7.01 (m, 70H,  $\text{CH}_{\text{arom}}$ ), 5.30 – 5.21 (m, 3H, H-1 $_{\text{Gal}''}$ , H-1 $_{\text{Gal}''}$ , H-1 $_{\text{Gal}}$ ), 5.12 (d,  $J = 1.9$  Hz, 1H, H-5 $_{\text{Gal}}$ ), 5.07 (d,  $J = 1.8$  Hz, 2H, 2xH-5 $_{\text{Gal}}$ ), 4.89 – 4.78 (m, 4H, H-1 $_{\text{Gal}}$ ,  $\text{CH}_2$  Bn), 4.78 – 4.19 (m, 29H, H-5 $_{\text{Gal}}$ , 3xH-4 $_{\text{Mann}}$ , 3xH-1 $_{\text{Mann}}$ , 3xH-3 $_{\text{Gal}}$ , 12.5x  $\text{CH}_2$  Bn), 4.16 – 4.02 (m, 4H, 4xH-4 $_{\text{Gal}}$ ), 4.02 – 3.91 (m, 3H, 3xH-5 $_{\text{Mann}}$ ), 3.87 (t,  $J = 3.6$  Hz, 1H, H-3 $_{\text{Gal}''}$ ), 3.77 (m, 5H,  $-\text{OCH}_2\text{CH}_2\text{CH}_2\text{N}_3$ , 4xH-2 $_{\text{Gal}}$ ), 3.68 (s, 3H,  $\text{CH}_3$  COO $\text{CH}_3$ ), 3.64 – 3.54 (m, 3H, 3xH-2 $_{\text{Mann}}$ ), 3.56 – 3.37 (m, 19H,  $-\text{OCH}_2\text{CH}_2\text{CH}_2\text{N}_3$ , 6x $\text{CH}_3$  COO $\text{CH}_3$ ), 3.34 (m, 5H, 3xH-3 $_{\text{Mann}}$ ,  $-\text{OCH}_2\text{CH}_2\text{CH}_2\text{N}_3$ ), 1.98 – 1.73 (m, 2H,  $-\text{OCH}_2\text{CH}_2\text{CH}_2\text{N}_3$ ).  $^{13}\text{C}$ -APT NMR ( $\text{CDCl}_3$ , 100 MHz, HSQC):  $\delta$  170.6, 170.3, 168.7, 168.6(-COO-), 139.3, 139.1, 138.9, 138.8, 138.3, 138.2, 138.1, 137.9, 137.9( $\text{C}_{\text{q arom}}$ ), 128.6, 128.5, 128.5, 128.4, 128.4, 128.4, 128.3, 128.1, 128.0, 128.0, 127.9, 127.8, 127.8, 127.8, 127.7, 127.7, 127.7, 127.6, 127.6, 127.5, 127.4( $\text{CH}_{\text{arom}}$ ), 103.5, 103.4(3xC-1 $_{\text{Mann}}$ ), 98.2, 97.2, 97.1(4xC-1 $_{\text{Gal}}$ ), 79.5, 79.5, 79.3(3xC-3 $_{\text{Mann}}$ ), 78.4, 78.3(C-4 $_{\text{Gal}}$ , C-4 $_{\text{Gal}''}$ , C-4 $_{\text{Gal}''}$ ), 76.3, 76.2, 76.1(3xC-5 $_{\text{Mann}}$ ), 75.2, 74.9, 74.5, 74.4, 74.3(4xC-3 $_{\text{Gal}}$ , 3xC-2 $_{\text{Mann}}$ ), 74.3, 74.2, 73.6, 73.3, 73.0(5x $\text{CH}_2$  Bn), 73.5, 73.3, 73.3, 73.2, 73.1, 73.1, 72.9(4xC-2 $_{\text{Gal}}$ , 3xC-4 $_{\text{Mann}}$ ), 71.7, 71.6, 71.3, 71.2, 71.1(4x $\text{CH}_2$  Bn), 70.0(C-4 $_{\text{Gal}''}$ ), 68.2, 67.4, 67.1(4xC-5 $_{\text{Gal}}$ ), 65.4( $-\text{OCH}_2\text{CH}_2\text{CH}_2\text{N}_3$ ), 52.3, 52.3, 52.3, 52.3, 52.0(7x-COO $\text{CH}_3$ ), 48.4( $-\text{OCH}_2\text{CH}_2\text{CH}_2\text{N}_3$ ), 29.0( $-\text{OCH}_2\text{CH}_2\text{CH}_2\text{N}_3$ ),  $^{13}\text{C}$ -HMBC ( $\text{CDCl}_3$ , 100 MHz): 103.5, 103.4( $J_{\text{C}1,\text{H}1} = 158\text{Hz}$ , 3xC-1 $_{\text{Mann}}$ ), 98.2( $J_{\text{C}1,\text{H}1} = 168\text{Hz}$ , C-1 $_{\text{Gal}}$ ), 97.2, 97.1 ( $J_{\text{C}1,\text{H}1} = 170\text{Hz}$ , C-1 $_{\text{Gal}''}$ , C-1 $_{\text{Gal}''}$ ).  $[\alpha]_{\text{D}}^{20} = -94^\circ$  ( $c = 0.44$ ,  $\text{CHCl}_3$ ). HR-MS:  $[\text{M}+\text{NH}_4^+]$  Calculated for  $\text{C}_{150}\text{H}_{161}\text{O}_{43}\text{N}_3$ : 2710.08421; found: 2710.10289.

**Tetrasaccharide (9):** See General procedure for delevulinoylation. starting material **3** (120 mg, 0.071 mmol) was

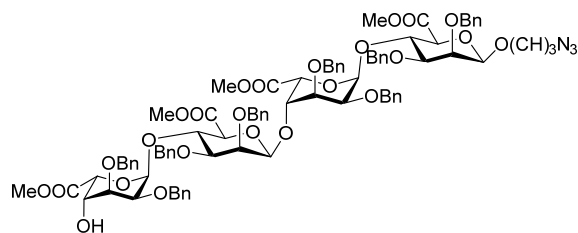

dissolved in a mixture of acetic acid and pyridine (1.25 ml, 1/4, v/v), the mixture was cooled to 0 °C and hydrazine hydrate (20 ul) was added to the solution. The reaction was allowed to stir for 20 min at room temperature. Then the reaction was diluted

with EtOAc, washed with 1 N HCl, sat. aq.  $\text{NaHCO}_3$  and sat. aq. NaCl, the organic phase was dried over  $\text{Na}_2\text{SO}_4$  and

## Total Synthesis of Alginate fragments

concentrated *in vacuo*. Purification by column chromatography (silica gel, pentane/DCM/EtOAc, 3/1/1, v/v/v) yielded product **9** (88 mg, 78%). TLC:  $R_f = 0.40$  (toluene/acetone, 3/1, v/v);  $^1\text{H NMR}$  ( $\text{CDCl}_3$ , 400 MHz, HH-COSY, HSQC):  $\delta$  7.49 – 7.03 (m, 40H,  $\text{CH}_{\text{arom}}$ ), 5.29 (d,  $J = 3.9$  Hz, 1H, H-1 $_{\text{Gul}}$ ), 5.20 (d,  $J = 4.0$  Hz, 1H, H-1 $_{\text{Gul}}$ ), 5.13 (d,  $J = 1.9$  Hz, 1H, H-5 $_{\text{Gul}}$ ), 5.03 (d,  $J = 1.8$  Hz, 1H, H-5 $_{\text{Gul}}$ ), 4.91 – 4.18 (m, 21H, 2xH-1 $_{\text{Mann}}$ , 2xH-4 $_{\text{Mann}}$ , H-3 $_{\text{Gul}}$ , 8x  $\text{CH}_2\text{Bn}$ ), 4.10 (dt,  $J = 4.1, 1.8$  Hz, 1H, H-4 $_{\text{Gul}}$ ), 4.08 – 3.99 (m, 3H,  $-\text{OCH}_2\text{CH}_2\text{CH}_2\text{N}_3$ , H-4 $_{\text{Gul}}$ , H-5 $_{\text{Mann}}$ ), 3.96 (d,  $J = 8.6$  Hz, 1H, H-5 $_{\text{Mann}}$ ), 3.87 (t,  $J = 3.8$  Hz, 1H, H-3 $_{\text{Gul}}$ ), 3.83 (d,  $J = 3.4$  Hz, 1H, H-2 $_{\text{Mann}}$ ), 3.77 (dt,  $J = 6.9, 3.7$  Hz, 2H, H-2 $_{\text{Gul}}$ , H-2 $_{\text{Gul}}$ ), 3.57 (m, 1H, H-2 $_{\text{Mann}}$ ), 3.56 – 3.44 (m, 11H, H-3 $_{\text{Mann}}$ ,  $-\text{OCH}_2\text{CH}_2\text{CH}_2\text{N}_3$ , 3x $\text{CH}_3$   $\text{COOCH}_3$ ), 3.41 (s, 3H,  $\text{CH}_3$   $\text{COOCH}_3$ ), 3.39 – 3.28 (m, 3H, H-3 $_{\text{Mann}}$ ,  $-\text{OCH}_2\text{CH}_2\text{CH}_2\text{N}_3$ ), 1.96 – 1.75 (m, 2H,  $-\text{OCH}_2\text{CH}_2\text{CH}_2\text{N}_3$ );  $^{13}\text{C}$ -APT NMR ( $\text{CDCl}_3$ , 100 MHz, HSQC):  $\delta$  170.5, 170.2, 168.7, 168.7(-COO-), 139.3, 138.8, 138.7, 138.2, 138.1, 138.0, 137.8( $\text{C}_{\text{q arom}}$ ), 128.4, 128.4, 128.3, 128.3, 128.1, 128.1, 127.9, 127.9, 127.8, 127.8, 127.8, 127.7, 127.7, 127.7, 127.6, 127.6, 127.6, 127.5, 127.5, 127.5, 127.4, 127.3, 127.3, 127.2( $\text{CH}_{\text{arom}}$ ), 103.3(C-1 $_{\text{Mann}}$ ), 101.5(C-1 $_{\text{Mann}}$ ), 97.3(C-1 $_{\text{Gul}}$ ), 97.0(C-1 $_{\text{Gul}}$ ), 79.5(C-3 $_{\text{Mann}}$ ), 79.2(C-3 $_{\text{Mann}}$ ), 78.5(C-4 $_{\text{Gul}}$ ), 76.1(C-5 $_{\text{Mann}}$ ), 75.7(C-5 $_{\text{Mann}}$ ), 75.1(C-3 $_{\text{Gul}}$ ), 74.4, 74.3(C-3 $_{\text{Gul}}$ , C-2 $_{\text{Mann}}$ ), 74.2, 73.9, 73.8, 73.2(4x $\text{CH}_2\text{Bn}$ ), 73.4, 73.4, 73.1, 72.9, 72.9(C-2 $_{\text{Mann}}$ , C-4 $_{\text{Mann}}$ , C-4 $_{\text{Mann}}$ , C-2 $_{\text{Gul}}$ , C-2 $_{\text{Gul}}$ ), 71.6, 71.3, 71.3, 71.1(4x $\text{CH}_2\text{Bn}$ ), 70.0(C-4 $_{\text{Gul}}$ ), 68.1(C-5 $_{\text{Gul}}$ ), 67.4(C-5 $_{\text{Gul}}$ ), 66.8( $-\text{OCH}_2\text{CH}_2\text{CH}_2\text{N}_3$ ), 52.4, 52.3, 52.2, 52.0(4x-COO $\text{CH}_3$ ), 48.4( $-\text{OCH}_2\text{CH}_2\text{CH}_2\text{N}_3$ ), 29.1( $-\text{OCH}_2\text{CH}_2\text{CH}_2\text{N}_3$ );  $^{13}\text{C}$  -HMBC ( $\text{CDCl}_3$ , 100 MHz): 103.3( $J_{\text{C1,H1}} = 156\text{Hz}$ , C-1 $_{\text{Mann}}$ ), 101.5( $J_{\text{C1,H1}} = 156\text{Hz}$ , C-1 $_{\text{Mann}}$ ), 97.3( $J_{\text{C1,H1}} = 170\text{Hz}$ , C-1 $_{\text{Gul}}$ ), 97.0( $J_{\text{C1,H1}} = 170\text{Hz}$ , C-1 $_{\text{Gul}}$ ).  $[\alpha]_{\text{D}}^{20} = -80^\circ$  ( $c = 0.84$ ,  $\text{CHCl}_3$ ). IR (neat): 698, 737, 1028, 1038, 1065, 1101, 1115, 1207, 1238, 1456, 1749, 2097, 2924. HR-MS:  $[\text{M}+\text{Na}^+]$  Calculated for  $\text{C}_{87}\text{H}_{95}\text{O}_{25}\text{N}_3$ : 1606.61469; found: 1606.61593.

**Hexasaccharide (10)**: As described for the general procedure for glycosylation reactions, purification by size

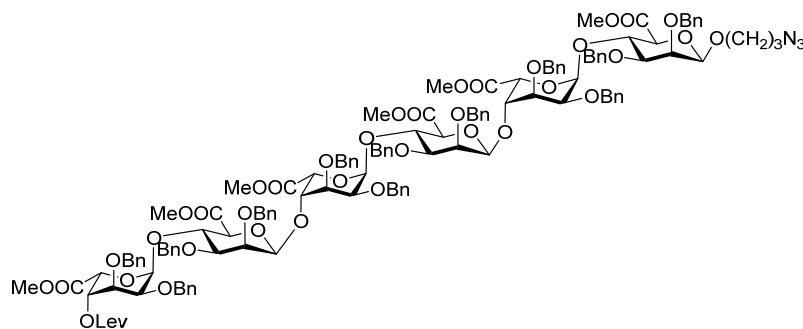

exclusion (LH-20, MeOH/DCM 1 :1) and column chromatography (silica gel, pentane/DCM/EtOAc, 4/1/1, v/v/v) yielded (silica gel, pentane/DCM/EtOAc, 4/1/1, v/v/v) **10** as a colourless

syrup (17 mg, 30%,  $\beta:\alpha > 20:1$ ). TLC:  $R_f = 0.53$  (toluene/acetone, 3/1, v/v);  $[\alpha]_{\text{D}}^{20} = -95^\circ$  ( $c = 0.48$ ,  $\text{CHCl}_3$ ).  $^1\text{H NMR}$  ( $\text{CDCl}_3$ , 850 MHz, HH-COSY, HSQC):  $\delta$  7.50 – 6.93 (m, 60H,  $\text{CH}_{\text{arom}}$ ), 5.28 – 5.16 (m, 5H, H-1 $_{\text{Gul}}$ , H-1 $_{\text{Gul}}$ , H-1 $_{\text{Gul}}$ , H-4 $_{\text{Gul}}$ , H-5 $_{\text{Gul}}$ ), 5.07 (d,  $J = 1.8$  Hz, 1H, H-5 $_{\text{Gul}}$ ), 5.02 (d,  $J = 1.8$  Hz, 1H, H-5 $_{\text{Gul}}$ ), 4.85 (dd,  $J = 12.0, 9.4$  Hz, 4H), 4.79 (d,  $J = 12.2$  Hz, 1H), 4.74 – 4.67 (m, 4H), 4.61 – 4.18 (m, 29H, 3xH-1 $_{\text{Mann}}$ ), 4.08 – 3.92 (m, 6H, 3xH-5 $_{\text{Mann}}$ , H-4 $_{\text{Gul}}$ ), 3.90 – 3.84 (m, 2H), 3.82 (dd,  $J = 2.7, 1.3$  Hz, 1H), 3.78 – 3.72 (m, 3H), 3.64 (t,  $J = 3.7$  Hz, 1H), 3.59 (d,  $J = 3.6$  Hz, 1H), 3.56 (t,  $J = 3.2$  Hz, 1H), 3.53 – 3.37 (m, 20H, 6x $\text{CH}_3$   $\text{COOCH}_3$ ,  $-\text{OCH}_2\text{CH}_2\text{CH}_2\text{N}_3$ , H-3 $_{\text{Mann}}$ ), 3.37– 3.27 (m, 4H,  $-\text{OCH}_2\text{CH}_2\text{CH}_2\text{N}_3$ , 2xH-3 $_{\text{Mann}}$ ), 2.73 – 2.56 (m, 2H,  $\text{CH}_2$  Lev), 2.49 – 2.37 (m, 2H,  $\text{CH}_2$  Lev), 2.15 (s, 3H,  $\text{COCH}_3$ ), 1.93 –





**Tetrasaccharide (12):** The tetrasaccharide was obtained as general procedure for hydrolysis of thioglycosidic bond

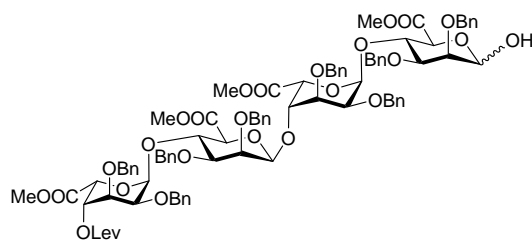

in 96% yield (350 mg). TLC:  $R_f = 0.24$  (toluene/EtOAc, 4/3, v/v);  $[\alpha]_D^{20} = -75^\circ$  ( $c = 0.58$ ,  $\text{CHCl}_3$ ).  $^1\text{H NMR}$  ( $\text{CDCl}_3$ , 400 MHz, HH-COSY, HSQC):  $\delta$  7.55 – 7.03 (m, 40H,  $\text{CH}_{\text{arom}}$ ), 5.48 (d,  $J = 6.1$  Hz, 1H, H-1 $_{\text{Gul}}$ ), 5.31 (d,  $J = 3.9$  Hz, 1H, H-1 $_{\text{Gul}}$ ), 5.25 (dd,  $J = 3.6, 1.8$  Hz, 1H, H-4 $_{\text{Gul}}$ ), 5.20 (d,  $J = 1.9$  Hz, 1H, H-5 $_{\text{Gul}}$ ), 5.08 (d,  $J = 3.8$  Hz, 1H, H-1 $_{\text{Mann}}$ ), 4.93 –

4.78 (m, 3H,  $\text{CH}_2\text{Bn}$ ), 4.77 – 4.69 (m, 3H, H-5 $_{\text{Gul}}$ ,  $\text{CH}_2\text{Bn}$ ), 4.61 – 4.22 (m, 20H, H-1 $_{\text{Mann}}$ , H-4 $_{\text{Mann}}$ , H-4 $_{\text{Mann}}$ ,  $\text{CH}_2\text{Bn}$ ), 4.13 (dd,  $J = 3.8, 1.8$  Hz, 1H, H-5 $_{\text{Mann}}$ ), 4.04 (d,  $J = 8.2$  Hz, 1H, H-5 $_{\text{Mann}}$ ), 3.89 (d,  $J = 3.5$  Hz, 1H, H-3 $_{\text{Gul}}$ ), 3.84 (q,  $J = 3.4, 2.8$  Hz, 2H, H-2 $_{\text{Mann}}$ , H-3 $_{\text{Mann}}$ ), 3.67 (t,  $J = 3.7$  Hz, 1H, H-2 $_{\text{Gul}}$ ), 3.61 (d,  $J = 2.7$  Hz, 1H, H-2 $_{\text{Mann}}$ ), 3.56 (s, 3H,  $\text{CH}_3\text{OCO}-$ ), 3.53 (d,  $J = 2.8$  Hz, 4H,  $\text{CH}_3\text{OCO}-$ , H-2 $_{\text{Gul}}$ ), 3.48 (s, 1H,  $\text{CH}_3\text{OCO}-$   $\beta$  isomer), 3.46 (d,  $J = 1.1$  Hz, 6H,  $2 \times \text{CH}_3\text{OCO}-$ ), 3.37 (dd,  $J = 9.2, 2.7$  Hz, 1H, H-3 $_{\text{Mann}}$ ), 2.79 – 2.53 (m, 2H,  $\text{CH}_2$  Lev), 2.52 – 2.32 (m, 2H,  $\text{CH}_2$  Lev), 2.13 (s, 3H,  $\text{CH}_3\text{CO}$ );  $^{13}\text{C}$  –APT NMR ( $\text{CDCl}_3$ , 100 MHz, HSQC):  $\delta$  206.2(C=O Lev), 171.5, 169.9, 169.8, 169.0, 168.6(-COO $\text{CH}_3$ ), 139.1, 138.6, 138.6, 138.5, 138.0, 138.0, 137.9, 137.6( $\text{C}_{\text{q arom}}$ ), 128.5, 128.4, 128.3, 128.2, 128.2, 128.1, 128.0, 127.9, 127.9, 127.8, 127.7, 127.7, 127.6, 127.6, 127.5, 127.5, 127.4, 127.3, 127.2( $\text{CH}_{\text{arom}}$ ), 103.3(C-1 $_{\text{Mann}}$ ), 98.1(C-1 $_{\text{Mann}}$ ), 96.6(C-1 $_{\text{Gul}}$ ), 93.7(C-1 $_{\text{Mann}}$ ,  $\beta$  isomer), 92.6(C-1 $_{\text{Gul}}$ ), 79.3(C-3 $_{\text{Mann}}$ ), 78.4(C-4 $_{\text{Mann}}$ ), 77.5, 77.4(C-2 $_{\text{Mann}}$ ), 77.2, 76.8, 76.7(C-2 $_{\text{Gul}}$ , C-5 $_{\text{Mann}}$ ), 76.5, 76.1, 75.2, 74.4, 74.2, 74.1, 73.7, 73.3, 73.2, 73.1, 72.9, 72.8, 72.4, 72.3, 72.2, 71.3, 71.2, 70.9(C-4 $_{\text{Gul}}$ ), 67.6(C-5 $_{\text{Gul}}$ ), 66.2(C-5 $_{\text{Gul}}$ ), 52.4, 52.3, 52.1, 52.0(-COO $\text{CH}_3$ ), 37.8( $\text{CH}_2$  Lev), 29.7( $\text{CH}_3\text{CO}$ ), 28.0( $\text{CH}_2$  Lev);  $^{13}\text{C}$ -HMBC ( $\text{CDCl}_3$ , 100 MHz): 103.3( $J_{\text{C1,H1}} = 158\text{Hz}$ , C-1 $_{\text{Mann}}$ ), 98.1( $J_{\text{C1,H1}} = 169\text{Hz}$ , C-1 $_{\text{Mann}}$ ), 96.6( $J_{\text{C1,H1}} = 171\text{Hz}$ , C-1 $_{\text{Gul}}$ ), 92.6( $J_{\text{C1,H1}} = 171\text{Hz}$ , C-1 $_{\text{Gul}}$ ). IR (neat): 601, 698, 737, 908, 957, 1028, 1067, 1090, 1119, 1175, 1206, 1238, 1286, 1302, 1331, 1362, 1437, 1454, 1497, 1719, 1744, 2870, 2949, 3030, 3462. HR-MS:  $[\text{M}+\text{Na}^+]$  Calculated for  $\text{C}_{89}\text{H}_{96}\text{O}_{27}$ : 1619.60312; found: 1619.60402.

**The tetrasaccharide imidate donor 13** was obtained as described for yield *N*-phenyl-trifluoroacetimidate donor

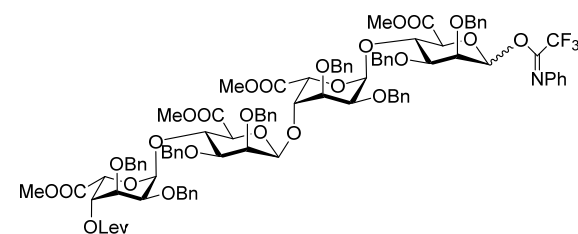

(360 mg, 96%,  $\alpha : \beta = 2.4:1$ ). TLC:  $R_f = 0.40$  (pentane/DCM/EtOAc, 2/1/1, v/v/v);  $^1\text{H NMR}$  ( $\text{CDCl}_3$ , 400 MHz, HH-COSY, HSQC):  $\delta$  7.56 – 7.00 (m, 43H,  $\text{CH}_{\text{arom}}$ ), 6.87 – 6.78 (m, 2H,  $\text{CH}_{\text{arom}}$ ), 6.46 (bs, 0.80H, H-1 $_{\text{Mann}}$ ,  $\alpha$  isomer), 6.26 (bs, 0.34H, H-1 $_{\text{Mann}}$ ,  $\beta$  isomer), 5.31 (t,  $J = 3.6$  Hz, 1H, H-1 $_{\text{Gul}}$ ), 5.28 – 5.23 (m,

1H, H-4 $_{\text{Gul}}$ ), 5.21 (d,  $J = 1.9$  Hz, 1H, H-5 $_{\text{Gul}}$ ), 5.12 (d,  $J = 4.0$  Hz, 0.72H, H-1 $_{\text{Gul}}$ ), 5.09 (d,  $J = 4.0$  Hz, 0.32H, H-1 $_{\text{Gul}}$ ), 4.98 – 4.78 (m, 3H), 4.77 – 4.63 (m, 3H), 4.63 – 4.23 (m, 13H), 4.23 – 4.12 (m, 1H), 4.06 (dd,  $J = 8.2, 4.9$  Hz, 1H), 3.95 (t,  $J = 3.0$  Hz, 0H), 3.88 (dt,  $J = 14.6, 3.5$  Hz, 2H), 3.75 (dd,  $J = 7.7, 4.7$  Hz, 2H), 3.67 (t,  $J = 3.7$  Hz, 1H), 3.62 (d,  $J = 4.2$  Hz,

## Chapter 4

2H), 3.59 (s, 2H), 3.54 (s, 2H), 3.53 (s, 1H), 3.50 (s, 3H), 3.47 (s, 3H), 3.40 – 3.34 (m, 1H), 2.76-2.53(m, 1H), 2.48 – 2.31 (m, 2H), 2.14 (s, 3H);  $^{13}\text{C}$ -APT NMR ( $\text{CDCl}_3$ , 100 MHz, HSQC):  $\delta$  206.2, 171.5, 170.0, 169.9, 169.0, 168.9, 168.6, 139.1, 138.7, 138.6, 138.1, 138.0, 137.7, 137.6, 128.7, 128.6, 128.5, 128.4, 128.4, 128.3, 128.3, 128.3, 128.3, 128.1, 128.1, 128.0, 128.0, 127.9, 127.8, 127.8, 127.7, 127.7, 127.7, 127.6, 127.5, 127.5, 127.5, 127.3, 127.3, 127.2, 124.3, 123.9, 103.3(C-1<sub>Mann</sub>'), 98.5, 98.0(C-1<sub>Gul</sub>'), 96.7(C-1<sub>Gul</sub>'), 94.4(C-1<sub>Mann</sub>) 92.7(C-1<sub>Mann</sub>'), 77.5, 77.2, 76.8, 74.2, 73.7, 73.5, 73.0, 72.5, 72.5, 71.5, 71.3, 71.3, 52.3, 52.3, 52.2, 52.1, 37.9, 28.0;  $^{13}\text{C}$ -HMBC ( $\text{CDCl}_3$ , 100 MHz): 103.3( $J_{\text{C1,H1}} = 157\text{Hz}$ , C-1<sub>Mann</sub>'), 98.5, 98.0( $J_{\text{C1,H1}} = 169\text{Hz}$ , C-1<sub>Gul</sub>'), 96.7( $J_{\text{C1,H1}} = 169\text{Hz}$ , C-1<sub>Gul</sub>'). IR (neat): 601, 638, 696, 735, 777, 908, 961, 1028, 1058, 1092, 1119, 1152, 1206, 1240, 1304, 1323, 1362, 1437, 1454, 1497, 1597, 1719, 1746, 2952. HR-MS:  $[\text{M}+\text{Na}^+]$  Calculated for  $\text{C}_{97}\text{H}_{100}\text{F}_3\text{NO}_{27}$ : 1790.63270; found: 1790.63398.

**Texasaccharide (16):** As described for the general procedure for the glycosylation reactions. Purification by size

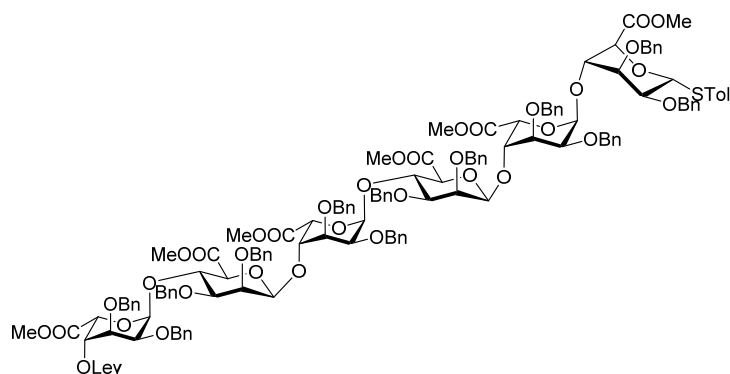

exclusion and column chromatography (silica gel, pentane/DCM/EtOAc, 3/1/1, v/v/v) yielded **16** as a colourless oil (116 mg, 73%,  $\beta:\alpha > 20:1$ ). TLC:  $R_f = 0.55$  (toluene/EtOAc, 4/3, v/v);  $[\alpha]_{\text{D}}^{20} = +42^\circ$  ( $c = 1$ ,  $\text{CHCl}_3$ ).  $^1\text{H}$  NMR ( $\text{CDCl}_3$ , 400 MHz, HH-COSY, HSQC):  $\delta$

7.52 (d,  $J = 8.2$  Hz, 2H), 7.48 – 6.96 (m, 62H), 5.67 (d,  $J = 7.8$  Hz, 1H, H-1<sub>Mann</sub>'), 5.29 (d,  $J = 4.0$  Hz, 1H, H-1<sub>Gul</sub>'), 5.27 – 5.22 (m, 2H, H-1<sub>Gul</sub>'), H-4<sub>Gul</sub>'), 2xH-5<sub>Gul</sub>'), 5.20 (d,  $J = 1.9$  Hz, 1H, H-5<sub>Gul</sub>'), 5.09 (d,  $J = 1.7$  Hz, 1H, H-1<sub>Gul</sub>'), 5.05 (d,  $J = 4.0$  Hz, 1H, H-1<sub>Gul</sub>'), 4.97 – 4.81 (m, 3H), 4.81 – 4.65 (m, 4H), 4.64 – 4.21 (m, 21H), 4.15 (dd,  $J = 3.8, 1.8$  Hz, 1H, H-4<sub>Gul</sub>'), 4.07 (dd,  $J = 3.7, 1.8$  Hz, 1H, H-4<sub>Gul</sub>'), 4.02 (d,  $J = 8.2$  Hz, 1H, H-5<sub>Gul</sub>'), 3.97 (d,  $J = 8.3$  Hz, 1H, H-5<sub>Gul</sub>'), 3.89 (t,  $J = 3.7$  Hz, 1H), 3.84 (t,  $J = 3.5$  Hz, 1H), 3.81 – 3.69 (m, 2H), 3.68 – 3.61 (m, 2H), 3.58 (d,  $J = 2.4$  Hz, 3H), 3.52 (s, 3H), 3.49 (d,  $J = 2.7$  Hz, 0H), 3.47 (s, 2H), 3.45 (s, 6H), 3.40 (s, 3H), 3.39 – 3.35 (m, 1H, H-3<sub>Mann</sub>'), 3.34 – 3.29 (m, 1H, H-3<sub>Mann</sub>'), 2.79 – 2.51 (m, 2H), 2.44 (dd,  $J = 6.4, 4.3$  Hz, 2H), 2.27 (s, 3H), 2.14 (s, 3H);  $^{13}\text{C}$ -APT NMR ( $\text{CDCl}_3$ , 100 MHz, HSQC):  $\delta$  206.2, 171.5, 170.2, 169.9, 169.5, 169.0, 168.6, 139.2, 139.1, 138.8, 138.8, 138.5, 138.2, 138.2, 138.1, 138.0, 137.9, 137.8, 137.6, 131.8, 130.4, 129.6, 128.4, 128.4, 128.3, 128.3, 128.2, 128.2, 128.1, 128.1, 128.0, 127.9, 127.8, 127.8, 127.7, 127.7, 127.6, 127.6, 127.5, 127.5, 127.5, 127.4, 127.2, 127.2, 103.3, 103.3(C-1<sub>Mann</sub>'', C-1<sub>Mann</sub>''), 97.9, 97.1, 96.6(3xC-1<sub>Gul</sub>'), 79.5, 79.3(C-3<sub>Mann</sub>'', C-3<sub>Mann</sub>'), 78.7, 78.3(C-4<sub>Gul</sub>'), C-4<sub>Gul</sub>'), 77.5, 77.4( $\text{HCCl}_3$ ), 77.2, 76.8( $\text{DCCl}_3$ ), 76.3, 76.1(C-5<sub>Mann</sub>'', C-5<sub>Mann</sub>'), 74.9, 74.4, 74.3, 74.3, 74.3, 74.2, 74.2, 74.1, 73.5, 73.3, 73.2, 73.2, 73.0, 72.9, 72.5, 72.5, 72.4, 72.3, 71.4, 71.2, 71.2, 71.1, 71.0, 67.8, 67.4, 66.3, 52.3, 52.2, 52.1, 52.1, 52.0, 51.9, 37.9, 29.8, 28.0, 21.1. IR (neat): 698, 737, 908, 1028, 1057, 1094, 1119, 1207, 1240, 1362, 1437, 1454, 1497, 1747,

## Total Synthesis of Alginate fragments

2951. HR-MS:  $[M+Na]^+$  Calculated for  $C_{138}H_{146}SO_{38}$ : 2465.91050; found: 2465.89507.

The hexasaccharide was obtained as general procedure for hydrolysis of thioglycosidic bond (74 mg, 81%). TLC:  $R_f =$

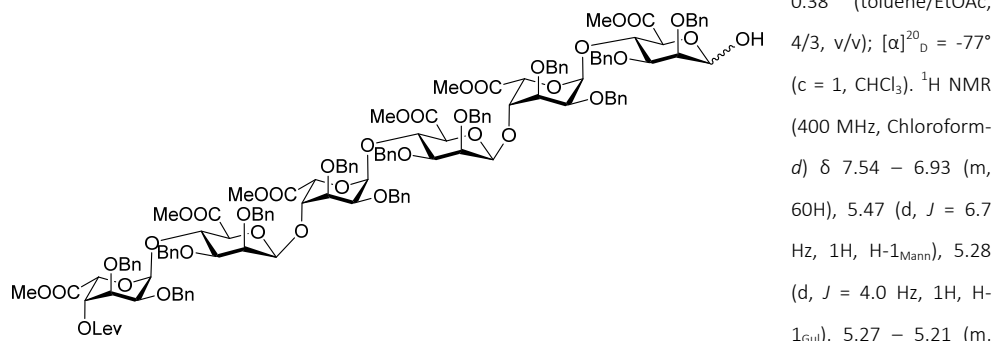

0.38 (toluene/EtOAc, 4/3, v/v);  $[\alpha]^{20}_D = -77^\circ$  (c = 1,  $CHCl_3$ ).  $^1H$  NMR (400 MHz, Chloroform-*d*)  $\delta$  7.54 – 6.93 (m, 60H), 5.47 (d,  $J = 6.7$  Hz, 1H, H-1<sub>Mann</sub>), 5.28 (d,  $J = 4.0$  Hz, 1H, H-1<sub>Gul</sub>), 5.27 – 5.21 (m,

2H, H-1<sub>Gul</sub>, H-4<sub>Gul</sub>), 5.19 (d,  $J = 2.0$  Hz, 1H), 5.08 (d,  $J = 1.8$  Hz, 1H, H-5<sub>Gul</sub>), 5.05 (d,  $J = 3.8$  Hz, 1H, H-1<sub>Gul</sub>), 4.90 – 4.78 (m, 4H), 4.72 (d,  $J = 2.0$  Hz, 2H), 4.69 (s, 2H), 4.63 – 4.20 (m, 26H), 4.14 (dd,  $J = 3.8, 1.8$  Hz, 1H, H-4<sub>Gul</sub>), 4.07 (dd,  $J = 3.9, 1.5$  Hz, 1H, H-4<sub>Gul</sub>), 4.03 (d,  $J = 8.2$  Hz, 1H, H-5<sub>Mann</sub>), 3.97 (d,  $J = 8.5$  Hz, 1H, H-5<sub>Mann</sub>), 3.88 (t,  $J = 3.6$  Hz, 1H), 3.83 (dt,  $J = 7.7, 3.1$  Hz, 1H), 3.77 (t,  $J = 3.6$  Hz, 1H), 3.68 – 3.61 (m, 3H), 3.59 (s, 2H), 3.57 (d,  $J = 2.5$  Hz, 1H), 3.52 (d,  $J = 9.7$  Hz, 4H), 3.48 (s, 1H), 3.47 (s, 3H), 3.45 (s, 4H), 3.44 (s, 2H), 3.40 (s, 3H), 3.39 – 3.36 (m, 1H), 3.32 (dd,  $J = 9.2, 2.8$  Hz, 1H, H-3<sub>Mann</sub>), 2.81 – 2.53 (m, 3H), 2.44 (m, 2H), 2.14 (s, 3H);  $^{13}C$  –APT NMR ( $CDCl_3$ , 100 MHz, HSQC):  $\delta$  206.2, 171.6, 170.2, 169.9, 169.8, 169.0, 168.6, 139.2, 139.1, 138.8, 138.8, 138.6, 138.5, 138.2, 138.1, 138.0, 137.9, 137.7, 128.5, 128.4, 128.4, 128.3, 128.3, 128.2, 128.2, 128.1, 128.1, 128.0, 128.0, 127.9, 127.9, 127.8, 127.8, 127.7, 127.7, 127.6, 127.5, 127.5, 127.4, 127.3, 127.2, 103.4, 103.3(C-1<sub>Mann</sub>′, C-1<sub>Mann</sub>′), 98.3, 97.1, 96.7(3xC-1<sub>Gul</sub>), 92.7(C-1<sub>Mann</sub>), 79.5, 79.3, 78.3, 77.5, 77.4, 77.2, 76.8, 76.7, 76.3, 76.1, 75.4, 74.5, 74.3, 74.2, 74.2, 73.9, 73.4, 73.4, 73.3, 73.2, 73.1, 73.0, 72.9, 72.9, 72.5, 72.4, 72.4, 71.5, 71.3, 71.2, 71.1, 71.0(C-4<sub>Gul</sub>′), 67.7, 67.4, 66.3(3xC-5<sub>Gul</sub>), 52.3, 52.3, 52.2, 52.1, 52.1, 51.9, 37.9, 29.8, 28.1;  $^{13}C$ -HMBC ( $CDCl_3$ , 100 MHz): 103.4, 103.3( $J_{C1,H1} = 158$ Hz, C-1<sub>Mann</sub>′, C-1<sub>Mann</sub>′), 98.3, 97.1, 96.7( $J_{C1,H1} = 168$ Hz,  $J_{C1,H1} = 171$ Hz,  $J_{C1,H1} = 171$ Hz, 3xC-1<sub>Gul</sub>), 92.7( $J_{C1,H1} = 171$ Hz, C-1<sub>Mann</sub>′). IR (neat): 698, 737, 910, 1028, 1061, 1098, 1117, 1206, 1238, 1304, 1362, 1454, 1748, 2870, 2949, 3030. HR-MS:  $[M+Na]^+$  Calculated for  $C_{131}H_{140}O_{39}$ : 2359.88639; found: 2359.88290.

## Chapter 4

The hexasaccharide imidate donor **17**: was obtained as general procedure for yield *N*-phenyl-trifluoroacetimidate

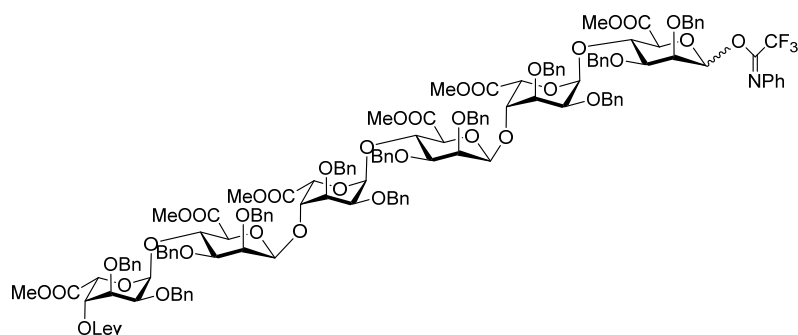

donor (74 mg,

99%,  $\alpha$ :  $\beta$  = 3.2:1).

TLC:  $R_f$  = 0.65

(toluene/EtOAc,

4/3, v/v);  $[\alpha]_D^{20}$  = -

80° (c = 1, CHCl<sub>3</sub>).

<sup>1</sup>H NMR (CDCl<sub>3</sub>,

400 MHz, HH-COSY,

HSQC):  $\delta$  7.56 –

6.96 (m, 63H), 6.82 (dd,  $J$  = 8.2, 1.9 Hz, 2H), 6.45 (s, 0.76H, H-1<sub>Mann</sub>  $\alpha$  isomer), 6.25 (s, 0.24H, H-1<sub>Mann</sub>  $\beta$  isomer), 5.28 (d,  $J$  = 3.9 Hz, 1H, H-1<sub>Gul</sub>), 5.27 – 5.21 (m, 2H, H-1<sub>Gul</sub>, H-4<sub>Gul</sub>), 5.19 (d,  $J$  = 1.9 Hz, 1H, H-5<sub>Gul</sub>), 5.12 – 5.05 (m, 2H, H-1<sub>Gul</sub>, H-5<sub>Gul</sub>), 4.94 – 4.77 (m, 3H), 4.78 – 4.63 (m, 4H), 4.64 – 4.19 (m, 18H), 4.15 (dd,  $J$  = 3.8, 1.9 Hz, 1H), 4.07 (dd,  $J$  = 3.8, 1.8 Hz, 1H), 4.02 (d,  $J$  = 8.3 Hz, 1H), 3.97 (d,  $J$  = 8.3 Hz, 1H), 3.88 (t,  $J$  = 3.6 Hz, 1H), 3.84 (t,  $J$  = 3.6 Hz, 1H), 3.80 – 3.69 (m, 2H), 3.64 (t,  $J$  = 3.6 Hz, 2H), 3.58 (d,  $J$  = 6.3 Hz, 3H), 3.51 (s, 3H), 3.49 (s, 3H), 3.45 (s, 6H), 3.40 (s, 3H), 3.37 (m, 1H), 3.35 – 3.29 (m, 1H), 2.80 – 2.50 (m, 2H), 2.53 – 2.22 (m, 2H), 2.15 (d,  $J$  = 9.5 Hz, 3H); <sup>13</sup>C –APT NMR (CDCl<sub>3</sub>, 100 MHz, HSQC):  $\delta$  206.2, 171.6, 170.3, 170.0, 169.1, 168.6, 139.2, 139.1, 138.8, 138.8, 138.6, 138.2, 138.1, 138.0, 137.8, 137.7, 128.7, 128.7, 128.5, 128.4, 128.4, 128.4, 128.3, 128.3, 128.1, 128.1, 128.0, 128.0, 127.9, 127.9, 127.8, 127.8, 127.7, 127.7, 127.7, 127.6, 127.6, 127.5, 127.5, 127.5, 127.2, 127.2, 127.1, 124.3, 123.9, 119.7, 119.6, 103.4, 103.3(C-1<sub>Mann'</sub>, C-1<sub>Mann''</sub>), 98.5, 98.1, 97.1, 96.7(3x C-1<sub>Gul</sub>), 94.4(C-1<sub>Mann</sub>), 79.5, 79.3, 78.6, 78.4, 76.8, 76.6, 76.3, 76.1, 75.7, 74.8, 74.4, 74.3, 74.2, 74.2, 73.7, 73.3, 73.3, 73.0, 73.0, 72.5, 72.5, 72.3, 71.3, 71.3, 71.2, 71.2, 71.1, 71.0, 67.7, 67.4, 66.3, 53.9, 53.0, 52.3, 52.3, 52.3, 52.2, 51.9, 46.2, 37.9, 29.8, 29.4, 28.1; <sup>13</sup>C-HMBC (CDCl<sub>3</sub>, 100 MHz): 103.4, 103.3( $J_{C1,H1}$  = 158Hz, C-1<sub>Mann'</sub>, C-1<sub>Mann''</sub>), 98.5, 97.1, 96.7( $J_{C1,H1}$  = 169Hz,  $J_{C1,H1}$  = 169Hz,  $J_{C1,H1}$  = 171Hz, 3x C-1<sub>Gul</sub>). IR (neat): 696, 735, 908, 959, 1028, 1055, 1094, 1117, 1206, 1238, 1304, 1329, 1360, 1454, 1748, 2872. HR-MS: [M+Na<sup>+</sup>] Calculated for C<sub>139</sub>H<sub>144</sub>F<sub>3</sub>NO<sub>39</sub>: 2530.91598; found: 2530.91172.

Trisaccharide **19**: As described for the general procedure for the glycosylation reactions. **19** was obtained (1.86 g,

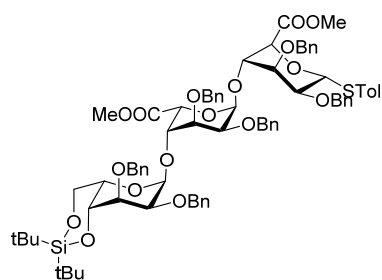

92%). TLC:  $R_f$  = 0.10 (Pentane/EtOAc, 10/1, v/v).  $[\alpha]_D^{20}$  = -47° (c =

0.98, CHCl<sub>3</sub>). <sup>1</sup>H NMR (CDCl<sub>3</sub>, 400 MHz, HH-COSY, HSQC):  $\delta$  7.62 –

6.92 (m, 34H, CH<sub>arom</sub>), 5.68 (d,  $J$  = 7.9 Hz, 1H, H-1<sub>Mann</sub>), 5.24 – 5.11

(m, 1H, H-1<sub>Gul</sub>), 5.11 – 4.94 (m, 2H, H-1<sub>Gul</sub>, CHH Bn), 4.83 (d,  $J$  = 11.9

Hz, 1H, CHH Bn), 4.78 – 4.42 (m, 8H), 4.41 – 3.99 (m, 4H), 4.00 –

3.26 (m, 17H), 2.26 (s, 3H, CH<sub>3</sub> STol), 1.03 (s, 9H, 3xCH<sub>3</sub> *tert*-Bu),

0.91 (s, 9H, 3xCH<sub>3</sub> *tert*-Bu); <sup>13</sup>C –APT NMR (CDCl<sub>3</sub>, 100 MHz, HSQC):

$\delta$  170.0, 169.7(-COO-), 139.6, 138.9, 138.3, 138.2, 138.1, 137.9(C<sub>q</sub> arom), 131.8(CH<sub>arom</sub>), 130.4(C<sub>q</sub> arom), 129.6, 128.5,

## Total Synthesis of Alginate fragments

128.4, 128.4, 128.3, 128.3, 128.2, 128.0, 127.9, 127.8, 127.6, 127.6, 127.5(CH<sub>arom</sub>), 99.9(C-1<sub>Gul</sub>), 97.2(C-1<sub>Gul</sub>), 77.6, 77.3, 75.8, 75.3, 75.2, 74.9, 74.1, 73.7, 73.2, 72.5, 72.5, 71.6, 71.1, 68.2(C-5<sub>Gul</sub>), 66.8(C-6<sub>Gul</sub>), 64.8(C-5<sub>Gul</sub>), 52.1(-COOCH<sub>3</sub>), 27.7(CH<sub>3</sub> *tert*-Bu), 27.3(CH<sub>3</sub> *tert*-Bu), 23.3(C<sub>q</sub> *tert*-Bu), 21.2(CH<sub>3</sub> STol), 20.4(C<sub>q</sub> *tert*-Bu). IR (neat): 650, 698, 739, 799, 827, 868, 1028, 1088, 1117, 1140, 1207, 1306, 1364, 1454, 1472, 1494, 1734, 1753, 2859, 2932. HR-MS: [M+Na<sup>+</sup>] Calculated for C<sub>77</sub>H<sub>90</sub>O<sub>17</sub>SSi: 1369.55602; found: 1369.55666.

**Trisaccharide 20:** was obtained as described by the general procedure for removal of the di-*tert*-butyl silylidene

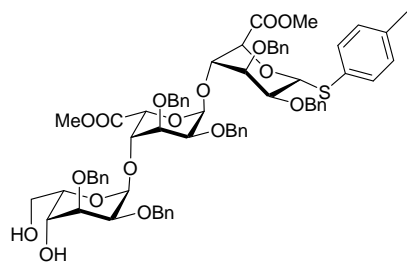

group (1.61 mg, 99%). TLC: R<sub>f</sub> = 0.40 (pentane/EtOAc, 1/1, v/v).

[α]<sub>D</sub><sup>20</sup> = -44° (c = 0.92, CHCl<sub>3</sub>). <sup>1</sup>H NMR (CDCl<sub>3</sub>, 400 MHz, HH-COSY, HSQC): δ 7.70 – 6.72 (m, 34H, CH<sub>arom</sub>), 5.68 (d, J = 7.9 Hz, 1H), 5.26 – 4.97 (m, 2H), 4.91 (d, J = 11.3 Hz, 1H), 4.87 – 4.29 (m, 11H), 4.29 – 3.94 (m, 2H), 3.91 – 3.28 (m, 15H), 2.25 (s, 3H, CH<sub>3</sub> STol); <sup>13</sup>C –APT NMR (CDCl<sub>3</sub>, 100 MHz, HSQC): δ 170.0, 169.7(-COO-), 139.4, 138.9, 138.3, 138.2, 138.2, 137.9(C<sub>q</sub> arom),

131.9(CH<sub>arom</sub>), 130.2(C<sub>q</sub> arom), 129.6, 128.3, 128.3, 127.9, 127.8, 127.6, 127.5, 127.3(CH<sub>arom</sub>), 100.0(C-1<sub>Gul</sub>), 97.2(C-1<sub>Gul</sub>), 77.4, 75.0, 74.8, 74.6, 74.3, 74.1, 73.9, 73.0, 72.8, 72.5, 72.4, 72.1, 71.7, 71.4, 68.1, 66.4, 64.0, 52.1(-COOCH<sub>3</sub>), 21.1(CH<sub>3</sub> STol). IR (neat): 612, 698, 735, 779, 810, 914, 949, 1028, 1074, 1088, 1103, 1209, 1242, 1282, 1306, 1323, 1362, 1393, 1437, 1454, 1495, 1734, 1749, 2870, 2922. HR-MS: [M+Na<sup>+</sup>] Calculated for C<sub>69</sub>H<sub>74</sub>O<sub>17</sub>S: 1229.45389; found: 1229.45418.

**The trisaccharide acceptor 21** was obtained as described by the general procedure for oxidation and methylation

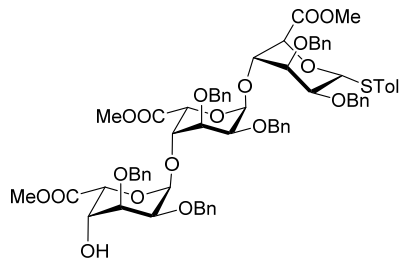

(85 mg, 76%). TLC: R<sub>f</sub> = 0.38 (pentane/DCM/EtOAc, 2/1/1, v/v).

[α]<sub>D</sub><sup>20</sup> = -42° (c = 1, CHCl<sub>3</sub>). <sup>1</sup>H NMR (CDCl<sub>3</sub>, 400 MHz, HH-COSY, HSQC): δ 7.52 (d, J = 8.3 Hz, 2H, CH<sub>arom</sub>), 7.47 – 7.08 (m, 30H, CH<sub>arom</sub>), 7.03 (d, J = 8.4 Hz, 2H, CH<sub>arom</sub>), 5.68 (d, J = 7.9 Hz, 1H), 5.16 (dd, J = 17.4, 3.7 Hz, 2H), 4.85 (dd, J = 11.6, 5.1 Hz, 2H), 4.70 (bs, 1H), 4.68 – 4.09 (m, 15H), 4.00 (s, 1H), 3.96 – 3.60 (m, 7H), 3.47 (d, J = 27.9 Hz, 6H), 2.26 (s, 3H, CH<sub>3</sub> STol); <sup>13</sup>C –APT NMR

(CDCl<sub>3</sub>, 100 MHz, HSQC): δ 170.3, 169.7, 169.6(-COO-), 139.0, 138.9, 138.2, 138.1, 138.0, 137.9, 137.0(C<sub>q</sub> arom), 131.8(CH<sub>arom</sub>), 130.4(C<sub>q</sub> arom), 129.6, 128.4, 128.2, 127.9, 127.8, 127.8, 127.7, 127.6, 127.5, 127.5(CH<sub>arom</sub>), 100.1(C-1<sub>Gul</sub>), 97.5(C-1<sub>Gul</sub>), 78.1, 77.4, 75.0, 75.0, 74.8, 74.8, 74.1, 73.9, 73.8, 73.4, 72.9, 72.5, 71.9, 71.7, 69.9, 68.7, 68.0, 52.5, 52.1, 52.0(-COOCH<sub>3</sub>), 21.1(CH<sub>3</sub> STol). IR (neat): 698, 737, 1028, 1076, 1092, 1119, 1209, 1240, 1306, 1358, 1454, 1495, 1736, 1751, 2870, 3030, 3497. HR-MS: [M+Na<sup>+</sup>] Calculated for C<sub>70</sub>H<sub>74</sub>O<sub>18</sub>S: 1257.44881; found: 1257.44898.

## Chapter 4

**Pentasaccharide 22** was obtained as described for the general procedure for the glycosylation reactions.

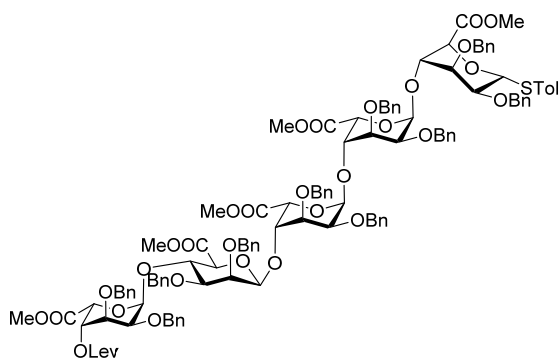

5H, H-1<sub>Gul</sub>, H-1<sub>Gul'</sub>, H-1<sub>Gul''</sub>, H-4<sub>Gul'</sub>, H-5<sub>Gul''</sub>, 4.93 – 4.78 (m, 3H), 4.73 (s, 1H), 4.70 (s, 1H), 4.65 (s, 1H), 4.62 – 4.49 (m, 7H), 4.45 (s, 3H), 4.41 – 4.33 (m, 2H), 4.33 – 4.23 (m, 3H), 4.16 (dd, *J* = 4.1, 1.8 Hz, 1H), 4.12 (d, *J* = 2.0 Hz, 1H), 4.05 (d, *J* = 8.2 Hz, 1H), 3.90 (dd, *J* = 8.1, 4.6 Hz, 2H), 3.83 (dd, *J* = 4.0, 2.8 Hz, 1H), 3.78 – 3.74 (m, 1H), 3.73 (t, *J* = 3.3 Hz, 1H), 3.70 – 3.52 (m, 6H), 3.50 (d, *J* = 0.9 Hz, 6H), 3.46-3.40 (m, 4H), 3.37 (s, 3H), 2.89 – 2.49 (m, 2H), 2.43 (m, 2H), 2.26 (s, 3H), 2.14 (s, 3H); <sup>13</sup>C –APT NMR (CDCl<sub>3</sub>, 100 MHz, HSQC): δ 206.2(C=O Lev), 171.5, 169.7, 169.6, 169.5, 169.0, 168.6(-COOCH<sub>3</sub>), 139.2, 139.0, 138.7, 138.5, 138.2, 138.2, 138.1, 137.9, 137.9, 137.7(C<sub>q</sub> arom), 131.7(CH<sub>arom</sub>), 130.4(C<sub>q</sub> arom), 129.5, 128.4, 128.4, 128.3, 128.3, 128.2, 128.2, 128.2, 128.1, 128.0, 127.9, 127.8, 127.8, 127.7, 127.7, 127.6, 127.5, 127.5, 127.4, 127.2(CH<sub>arom</sub>), 103.3(C-1<sub>Mann'</sub>), 100.1, 97.4, 96.6(3xC-1<sub>Gul</sub>), 79.4, 78.7, 78.0, 77.5, 77.4, 77.2, 76.8, 76.2, 75.2, 74.8, 74.2, 74.2, 73.7, 73.4, 73.3, 73.3, 73.1, 73.0, 72.5, 72.5, 72.4, 72.4, 71.7, 71.3, 71.3, 71.0, 71.0(C-4<sub>Gul''</sub>), 68.1, 67.8, 66.3(3xC-5<sub>Gul</sub>), 52.3, 52.3, 52.1, 52.0, 51.9(-COOCH<sub>3</sub>), 37.9(CH<sub>2</sub> Lev), 29.8(CH<sub>3</sub>CO), 28.0(CH<sub>2</sub> Lev), 21.1(CH<sub>3</sub> STol); <sup>13</sup>C-HMBC (CDCl<sub>3</sub>, 100 MHz): 103.3(*J*<sub>C1,H1</sub> = 158Hz, C-1<sub>Mann'</sub>), 100.1, 97.4, 96.6 (*J*<sub>C1,H1</sub> = 170Hz, 169Hz, 172Hz). IR (neat): 696, 735, 810, 910, 953, 1026, 1063, 1090, 1117, 1177, 1207, 1238, 1306, 1360, 1454, 1744, 2870, 2922. HR-MS: [M+H]<sup>+</sup> Calculated for C<sub>117</sub>H<sub>124</sub>O<sub>32</sub>S: 2073.78692; found: 2073.78474.

Purification by size exclusion (LH-20, DCM/MeOH, 1:1) and column chromatography (silica gel, DCM/acetone, 30/1, v/v) yielded **29** as a colourless syrup (112 mg, 87%, β:α > 20:1). TLC: R<sub>f</sub> = 0.58 (toluene/EtOAc, 4/3, v/v); [α]<sub>D</sub><sup>20</sup> = -66° (c = 1, CHCl<sub>3</sub>). <sup>1</sup>H NMR (CDCl<sub>3</sub>, 400 MHz, HH-COSY, HSQC): δ 7.69 – 6.72 (m, 54H, CH<sub>arom</sub>), 5.69 (d, *J* = 8.2 Hz, 1H, H-1<sub>Mann</sub>), 5.37 – 4.96 (m,

**This pentasaccharide** was obtained as general procedure for hydrolysis of thioglycosidic bond (67 mg, 98%). TLC: R<sub>f</sub>

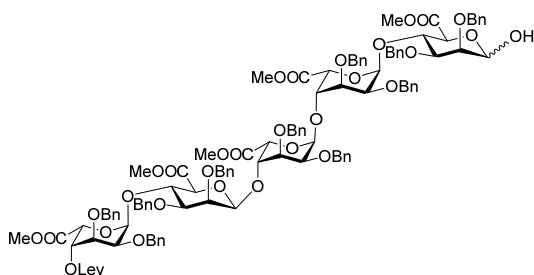

= 0.50 (DCM/acetone, 10/1, v/v); [α]<sub>D</sub><sup>20</sup> = -75° (c = 0.58, CHCl<sub>3</sub>). <sup>1</sup>H NMR (CDCl<sub>3</sub>, 400 MHz, HH-COSY, HSQC): δ 7.52 – 6.95 (m, 50H), 5.47 (d, *J* = 7.0 Hz, 1H, H-1<sub>Mann</sub>), 5.27 (d, *J* = 4.0 Hz, 1H, H-1<sub>Gul</sub>), 5.24 (dd, *J* = 3.9, 2.0 Hz, 1H, H-4<sub>Gul''</sub>), 5.19 (d, *J* = 2.0 Hz, 1H, H-5<sub>Gul</sub>), 5.17 (d, *J* = 3.9 Hz, 1H, H-1<sub>Gul</sub>), 5.13 (d, *J* = 3.9 Hz, 1H, H-1<sub>Gul</sub>), 4.86 (dt, *J* = 11.8, 4.7 Hz, 3H), 4.73 (d, *J* = 2.3 Hz, 1H), 4.70

(d, *J* = 2.5 Hz, 1H), 4.63 (d, *J* = 1.9 Hz, 1H), 4.60 – 4.13 (m, 19H), 4.11 (d, *J* = 12.0 Hz, 1H), 4.05 (d, *J* = 8.3 Hz, 1H),

## Total Synthesis of Alginate fragments

3.89 (d,  $J = 3.4$  Hz, 2H), 3.87 – 3.77 (m, 2H), 3.72 (dd,  $J = 5.3, 3.2$  Hz, 1H), 3.69 – 3.58 (m, 5H), 3.50 (d,  $J = 4.0$  Hz, 5H), 3.38 (d,  $J = 4.6$  Hz, 3H), 2.68 – 2.56 (m, 2H), 2.53 – 2.30 (m, 2H), 2.15 (s, 3H);  $^{13}\text{C}$ -APT NMR ( $\text{CDCl}_3$ , 100 MHz, HSQC):  $\delta$  206.3, 171.6, 170.0, 169.8, 169.5, 169.1, 168.7, 139.3, 139.1, 138.7, 138.6, 138.6, 138.1, 138.0, 138.0, 137.7, 128.5, 128.4, 128.4, 128.3, 128.3, 128.3, 128.2, 128.2, 128.1, 128.1, 127.9, 127.9, 127.8, 127.8, 127.7, 127.7, 127.6, 127.6, 127.6, 127.5, 127.3, 103.4(C-1<sub>Mann'</sub>), 100.2, 98.0, 96.7(3x C-1<sub>Gul</sub>), 92.7(C-1<sub>Mann</sub>), 79.4, 78.7, 77.8, 77.5, 77.2, 76.9, 76.8, 76.2, 75.6, 75.4, 74.3, 74.1, 73.7, 73.3, 73.2, 73.2, 73.0, 72.8, 72.6, 72.5, 72.4, 71.7, 71.4, 71.3, 71.1, 71.0, 68.0, 67.8, 66.3, 52.4, 52.2, 52.0, 52.0, 37.9, 29.8, 29.7, 28.1;  $^{13}\text{C}$ -HMBC ( $\text{CDCl}_3$ , 100 MHz): 103.4 ( $J_{\text{C1,H1}} = 158\text{Hz}$ , C-1<sub>Mann'</sub>), 100.2, 98.0, 96.7 ( $J_{\text{C1,H1}} = 171\text{Hz}$ ,  $J_{\text{C1,H1}} = 167\text{Hz}$ ,  $J_{\text{C1,H1}} = 175\text{Hz}$ , 3x C-1<sub>Gul</sub>), 92.7 ( $J_{\text{C1,H1}} = 170\text{Hz}$ , C-1<sub>Mann</sub>). IR (neat): 698, 739, 908, 1028, 1094, 1119, 1209, 1238, 1306, 1360, 1437, 1454, 1497, 1719, 1748, 2872, 2926, 3030. HR-MS:  $[\text{M}+\text{Na}^+]$  Calculated for  $\text{C}_{110}\text{H}_{118}\text{O}_{33}$ : 1389.74476; found: 1389.74550.

The pentasaccharide imidate donor **23** was obtained as general procedure for yield *N*-phenyl-trifluoroacetimidate

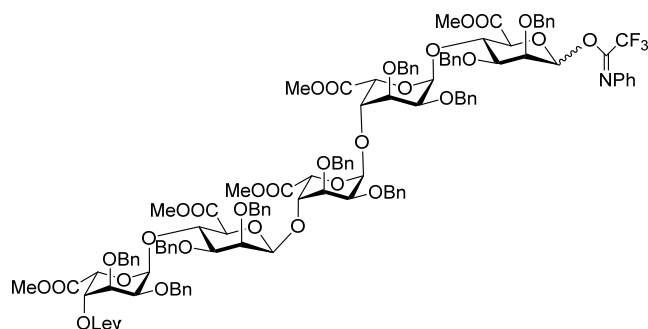

donor (65 mg, 84%,  $\alpha : \beta = 2.4:1$ ).

TLC:  $R_f = 0.33$  (pentane/DCM/EtOAc, 2/1/1, v/v/v);  $^1\text{H}$  NMR ( $\text{CDCl}_3$ , 400 MHz, HH-COSY, HSQC):  $\delta$  7.54 – 7.00 (m, 53H), 6.88 – 6.78 (m, 2H), 6.46 (s, 0.55H, H-1<sub>Mann</sub>  $\alpha$  isomer), 6.26 (s, 0.23H, H-1<sub>Mann</sub>  $\beta$  isomer), 5.28 (d,  $J = 3.5$  Hz, 1H, H-1<sub>Gul</sub>), 5.24 (dd,  $J = 3.7,$

1.8 Hz, 1H, H-4<sub>Gul'</sub>), 5.20 (d,  $J = 1.9$  Hz, 1H, H-5<sub>Gul</sub>), 5.17 (d,  $J = 3.9$  Hz, 2H, 2x H-1<sub>Gul</sub>), 4.87 (dd,  $J = 11.7, 6.0$  Hz, 2H), 4.77 – 4.64 (m, 3H), 4.61 – 4.19 (m, 15H), 4.18 – 4.11 (m, 1H), 4.11 – 4.02 (m, 2H), 3.90 (dt,  $J = 7.4, 3.5$  Hz, 2H), 3.86 – 3.80 (m, 1H), 3.76 – 3.69 (m, 2H), 3.69 – 3.57 (m, 4H), 3.55 – 3.48 (m, 5H), 3.46 (s, 2H), 3.39 (d,  $J = 9.0$  Hz, 3H), 2.79 – 2.57 (m, 2H), 2.51 – 2.36 (m, 2H), 2.15 (s, 3H);  $^{13}\text{C}$ -APT NMR ( $\text{CDCl}_3$ , 100 MHz, HSQC):  $\delta$  206.2, 171.6, 169.8, 169.6, 169.1, 169.1, 168.7, 139.3, 139.0, 138.7, 138.6, 138.2, 138.1, 138.1, 138.0, 138.0, 137.7, 137.7, 128.7, 128.7, 128.4, 128.4, 128.4, 128.3, 128.3, 128.2, 127.8, 127.8, 127.7, 127.7, 127.6, 127.6, 127.6, 127.5, 127.5, 127.4, 127.3, 127.2, 127.1, 119.6, 103.4(C-1<sub>Mann'</sub>), 100.4, 100.2, 98.3, 97.6, 96.7(C-1<sub>Gul</sub>), 94.3(C-1<sub>Mann</sub>), 79.4, 78.8, 78.0, 77.5, 77.2, 76.8, 76.6, 76.2, 75.5, 74.9, 74.4, 74.2, 74.2, 73.7, 73.5, 73.4, 73.3, 73.2, 73.0, 73.0, 72.7, 72.5, 72.4, 71.6, 71.3, 71.3, 71.1, 68.0, 67.8, 66.3, 52.4, 52.3, 46.2, 37.9, 30.4, 29.8, 28.1;  $^{13}\text{C}$ -HMBC ( $\text{CDCl}_3$ , 100 MHz): 103.4 ( $J_{\text{C1,H1}} = 158\text{Hz}$ , C-1<sub>Mann'</sub>), 100.2, 98.3, 97.6 ( $J_{\text{C1,H1}} = 170\text{Hz}$ ,  $J_{\text{C1,H1}} = 168\text{Hz}$ ,  $J_{\text{C1,H1}} = 171\text{Hz}$ , 3x C-1<sub>Gul</sub>). IR (neat): 696, 737, 910, 1028, 1063, 1072, 1092, 1117, 1206, 1240, 1306, 1360, 1437, 1454, 1497, 1720, 1744, 2855, 2924. HR-MS:  $[\text{M}+\text{Na}^+]$  Calculated for  $\text{C}_{118}\text{H}_{122}\text{F}_3\text{NO}_{33}$ : 2160.77434; found: 2160.77214.

## Chapter 4

Hexasaccharide **24** was obtained as described general procedure for the glycosylation reactions. Purification by

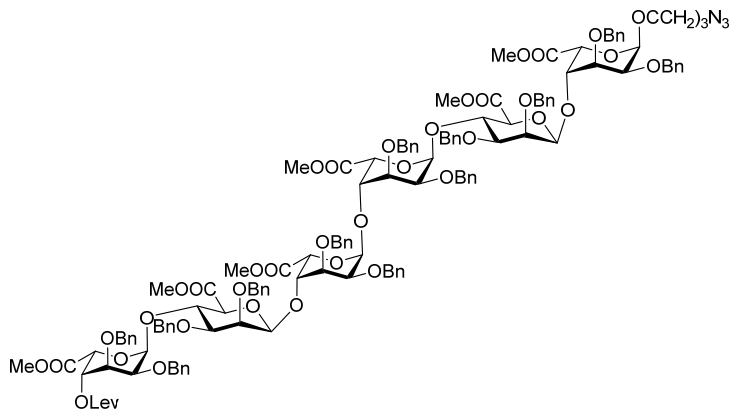

column chromatography

(silica gel,

pentane/DCM/EtOAc,

3/1/1, v/v/v) yielded **24**

(mg, 43%,  $\beta:\alpha > 20:1$ ).

$[\alpha]_D^{20} = -95^\circ$  ( $c = 0.44$ ,

$\text{CHCl}_3$ ).  $^1\text{H NMR}$  ( $\text{CDCl}_3$ , 400

MHz, HH-COSY, HSQC):  $\delta$

7.70 – 6.89 (m, 60H), 5.33

(d,  $J = 4.0$  Hz, 1H, H- $1_{\text{Gal}}$ ),

5.27 (d,  $J = 3.8$  Hz, 1H, H-

$1_{\text{Gal}}$ ), 5.23 (dd,  $J = 3.8, 1.9$  Hz, 1H, H- $4_{\text{Gal}}''$ ), 5.19 (d,  $J = 2.0$  Hz, 1H, H- $5_{\text{Gal}}$ ), 5.06 (d,  $J = 4.1$  Hz, 1H, H- $1_{\text{Gal}}$ ), 5.03 (d,  $J =$

1.9 Hz, 1H, H- $5_{\text{Gal}}$ ), 4.90 – 4.80 (m, 6H, H- $1_{\text{Gal}}$ ,  $\text{CH}_2$  Bn), 4.76 (d,  $J = 1.6$  Hz, 1H, H- $5_{\text{Gal}}$ ), 4.74 – 4.65 (m, 5H,  $\text{CH}_2$  Bn),

4.64 – 4.21 (m, 25H, 2xH- $1_{\text{Mann}}$ , 2xH- $4_{\text{Mann}}$ , 2xH- $3_{\text{Gal}}$ ,  $\text{CH}_2$  Bn), 4.18 (t,  $J = 3.6$  Hz, 1H, H- $4_{\text{Gal}}$ ), 4.11 (m, 2H, 2xH- $4_{\text{Gal}}$ ),

4.06 – 3.94 (m, 3H, 2xH- $5_{\text{Mann}}$ ,  $\text{CH}_2$  Bn), 3.92 – 3.75 (m, 5H, 2xH- $3_{\text{Gal}}$ , 2xH- $2_{\text{Gal}}$ ,  $-\text{OCH}_2\text{CH}_2\text{CH}_2\text{N}_3$ ), 3.70 – 3.63 (m, 5H,

2xH- $2_{\text{Gal}}$ ,  $\text{CH}_3\text{OCO}$ ), 3.60 (d,  $J = 3.4$  Hz, 5H, 2xH- $2_{\text{Mann}}$ ,  $\text{CH}_3\text{OCO}$ ), 3.50 (s, 3H,  $\text{CH}_3\text{OCO}$ ), 3.48 (s, 3H,  $\text{CH}_3\text{OCO}$ ), 3.45 (d,

$J = 1.6$  Hz, 4H,  $\text{CH}_3\text{OCO}$ ,  $-\text{OCH}_2\text{CH}_2\text{CH}_2\text{N}_3$ ), 3.41 (d,  $J = 1.0$  Hz, 1H), 3.40 – 3.27 (m, 4H, 2xH- $3_{\text{Mann}}$ ,  $-\text{OCH}_2\text{CH}_2\text{CH}_2\text{N}_3$ ),

3.21 (s, 3H,  $\text{CH}_3\text{OCO}$ ), 2.65 (dd,  $J = 15.2, 6.4$  Hz, 2H,  $\text{CH}_2$  Lev), 2.59 – 2.26 (m, 2H,  $\text{CH}_2$  Lev), 2.15 (s, 3H,  $\text{CH}_3\text{CO}$ ),

2.00 – 1.46 (m, 2H,  $-\text{OCH}_2\text{CH}_2\text{CH}_2\text{N}_3$ ).  $^{13}\text{C}$  –APT NMR ( $\text{CDCl}_3$ , 100 MHz, HSQC):  $\delta$  206.3(C=O Lev), 171.6, 170.3,

169.9, 169.8, 169.1, 168.8, 168.7( $-\text{COOCH}_3$ ), 139.3, 139.3, 139.1, 138.8, 138.7, 138.6, 138.3, 138.1, 138.0, 137.9,

137.8( $\text{C}_{\text{q arom}}$ ), 128.7, 128.6, 128.5, 128.5, 128.4, 128.4, 128.3, 128.3, 128.1, 128.1, 128.0, 127.9, 127.9, 127.8,

127.8, 127.7, 127.7, 127.6, 127.5, 127.5, 127.4, 127.4, 127.3, 127.3( $\text{CH}_{\text{arom}}$ ), 103.5, 103.4(2xC- $1_{\text{Mann}}$ ), 100.2, 98.2,

96.8, 96.7(4xC- $1_{\text{Gal}}$ ), 79.7, 79.5(2xC- $3_{\text{Mann}}$ ), 78.8, 78.2(3xC- $4_{\text{Gal}}$ ), 76.2(2xC- $5_{\text{Mann}}$ ), 75.5, 74.9(2xC- $3_{\text{Gal}}$ ), 74.3(2xC-

$2_{\text{Mann}}$ ), 74.2( $\text{CH}_2\text{Bn}$ ), 73.9, 73.8(C- $2_{\text{Gal}}$ , 2xC- $4_{\text{Mann}}$ ), 73.6( $\text{CH}_2\text{Bn}$ ), 73.5(C- $3_{\text{Gal}}$ ), 73.0( $\text{CH}_2\text{Bn}$ ), 72.8, 72.5(3xC- $2_{\text{Gal}}$ ),

72.4(C- $3_{\text{Gal}}$ ), 71.6, 71.5, 71.3, 71.1( $\text{CH}_2\text{Bn}$ ), 71.0(C- $4_{\text{Gal}}''$ ), 67.7, 67.1, 66.3(3xC- $5_{\text{Gal}}$ ), 65.3( $-\text{OCH}_2\text{CH}_2\text{CH}_2\text{N}_3$ ), 52.4,

52.3, 51.8(6x- $\text{COOCH}_3$ ), 48.4( $-\text{OCH}_2\text{CH}_2\text{CH}_2\text{N}_3$ ), 38.0( $\text{CH}_2$  Lev), 29.8( $\text{CH}_3\text{CO}$ ), 28.7( $-\text{OCH}_2\text{CH}_2\text{CH}_2\text{N}_3$ ), 28.0( $\text{CH}_2$  Lev);

$^{13}\text{C}$ -HMBC ( $\text{CDCl}_3$ , 100 MHz): 103.4 ( $J_{\text{C1,H1}} = 158\text{Hz}$ , C- $1_{\text{Mann}}$ ), 100.2, 98.3, 97.6 ( $J_{\text{C1,H1}} = 170\text{Hz}$ ,  $J_{\text{C1,H1}} = 168\text{Hz}$ ,  $J_{\text{C1,H1}} =$

171Hz, 3xC- $1_{\text{Gal}}$ ). IR (neat): 698, 737, 912, 1028, 1063, 1094, 1117, 1207, 1238, 1304, 1360, 1437, 1454, 1497,

2095, 2855, 2924, 3030. HR-MS:  $[\text{M}+\text{Na}^+]$  Calculated for  $\text{C}_{134}\text{H}_{145}\text{N}_3\text{O}_{39}$ : 2442.93494; found: 2442.92607.



**25** was obtained as described by the general procedure for delevulinoylation, saponification, high pressure

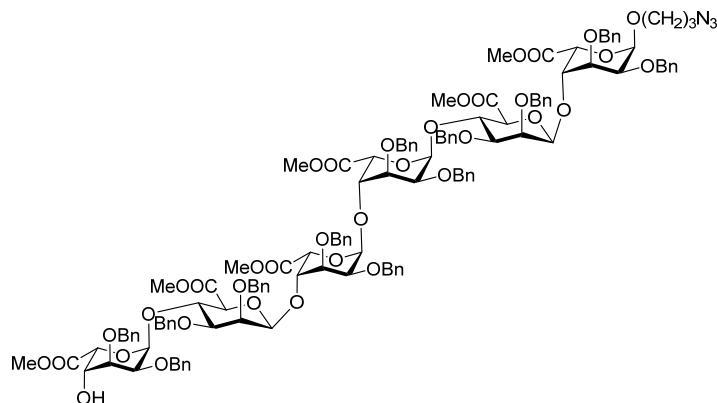

hydrogenation and

acetylation of

oligosaccharides as a white solid. **25**, (25 mg, 87%).

$[\alpha]_{\text{D}}^{20} = -76^\circ$  ( $c = 0.5$ ,  $\text{CHCl}_3$ ).

$^1\text{H}$  NMR ( $\text{CDCl}_3$ , 400

MHz, HH-COSY, HSQC):  $\delta$

7.58 – 6.94 (m, 60H), 5.33

(d,  $J = 4.0$  Hz, 1H, H-1<sub>Gul</sub>),

5.28 (d,  $J = 4.0$  Hz, 1H, H-

1<sub>Gul</sub>), 5.17 – 4.97 (m, 3H, H-

1<sub>Gul</sub>, 2xH-5<sub>Gul</sub>), 4.91 – 4.81 (m, 6H, H-1<sub>Gul</sub>, CH<sub>2</sub> Bn), 4.76 (d,  $J = 1.8$  Hz, 1H, H-5<sub>Gul</sub>), 4.73 (d,  $J = 3.1$  Hz, 1H, CH<sub>2</sub> Bn),

4.70 (d,  $J = 3.1$  Hz, 1H, CH<sub>2</sub> Bn), 4.68 – 4.22 (m, 27H, 2xH-1<sub>Mann</sub>, 2xH-4<sub>Mann</sub>, 2xH-3<sub>Gul</sub>, CH<sub>2</sub> Bn), 4.21 – 4.06 (m, 4H,

4xH-4<sub>Gul</sub>), 4.03 (d,  $J = 8.3$  Hz, 1H, H-5<sub>Mann</sub>), 3.99 – 3.93 (m, 1H, H-5<sub>Mann</sub>), 3.86 (dt,  $J = 13.1$ , 3.8 Hz, 2H, 2xH-3<sub>Gul</sub>), 3.79

(dt,  $J = 12.5$ , 4.1 Hz, 4H, -OCH<sub>2</sub>CH<sub>2</sub>CH<sub>2</sub>N<sub>3</sub>, 3xH-2<sub>Gul</sub>), 3.72 – 3.56 (m, 9H, H-2<sub>Gul</sub>, 2xH-2<sub>Mann</sub>, 2xCH<sub>3</sub>OCO), 3.53 (s, 3H,

CH<sub>3</sub>OCO), 3.48 (d,  $J = 1.3$  Hz, 7H, 2xCH<sub>3</sub>OCO, -OCH<sub>2</sub>CH<sub>2</sub>CH<sub>2</sub>N<sub>3</sub>), 3.43 – 3.27 (m, 4H, 2xH-3<sub>Mann</sub>, -OCH<sub>2</sub>CH<sub>2</sub>CH<sub>2</sub>N<sub>3</sub>), 3.21

(s, 3H, CH<sub>3</sub>OCO), 2.01 – 1.71 (m, 1H, -OCH<sub>2</sub>CH<sub>2</sub>CH<sub>2</sub>N<sub>3</sub>);  $^{13}\text{C}$  –APT NMR ( $\text{CDCl}_3$ , 100 MHz, HSQC):  $\delta$  170.5, 170.3,

169.9, 169.8, 168.8, 168.7(-COOCH<sub>3</sub>), 139.3, 139.3, 139.1, 138.9, 138.8, 138.7, 138.3, 138.1, 138.1, 137.9, 137.9(C<sub>q</sub>

arom), 128.5, 128.5, 128.4, 128.4, 128.4, 128.4, 128.3, 128.3, 128.1, 128.1, 128.0, 127.9, 127.9, 127.8, 127.8, 127.8,

127.7, 127.7, 127.6, 127.6, 127.6, 127.5, 127.4, 127.3, 127.3(CH<sub>arom</sub>), 103.5, 103.4(2xC-1<sub>Mann</sub>), 100.2, 98.2, 97.0,

96.8(4xC-1<sub>Gul</sub>), 79.7, 79.3(2xC-3<sub>Mann</sub>), 78.8, 78.2(3xC-4<sub>Gul</sub>), 77.5, 77.2, 76.8, 76.3, 76.2(2xC-5<sub>Mann</sub>), 75.5, 75.2,

74.9(3xC-3<sub>Gul</sub>), 74.3, 74.2(2xC-2<sub>Mann</sub>), 74.2(CH<sub>2</sub>Bn), 73.9, 73.9(2xC-2<sub>Gul</sub>), 73.6, 73.5, 73.3, 73.0(CH<sub>2</sub>Bn , 2xC-2<sub>Mann</sub>),

72.9(CH<sub>2</sub>Bn), 72.8(2xC-2<sub>Gul</sub>), 71.7, 71.6, 71.5, 71.4, 71.1(CH<sub>2</sub>Bn), 70.0(C-4<sub>Gul</sub>), 68.1, 67.7, 67.1(4xC-5<sub>Gul</sub>), 65.3(-

OCH<sub>2</sub>CH<sub>2</sub>CH<sub>2</sub>N<sub>3</sub>), 52.4, 52.4, 52.3, 51.8(6xC-COOCH<sub>3</sub>), 48.4(-OCH<sub>2</sub>CH<sub>2</sub>CH<sub>2</sub>N<sub>3</sub>), 28.7(-OCH<sub>2</sub>CH<sub>2</sub>CH<sub>2</sub>N<sub>3</sub>). IR (neat): 698,

737, 910, 1028, 1065, 1115, 1207, 1238, 1306, 1360, 1437, 1454, 1497, 1752, 2095, 2855, 2922, 3030. HR-MS:

[M+Na<sup>+</sup>] Calculated for C<sub>129</sub>H<sub>139</sub>N<sub>3</sub>O<sub>37</sub>: 2344.89796; found: 2344.89193.

### Disaccharide 26

**26-NH<sub>4</sub><sup>+</sup>**: was obtained as described by the general procedure for saponification, high-pressure hydrogenation and

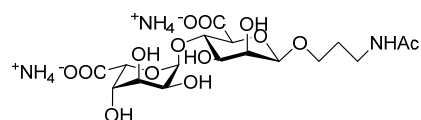

acetylation of oligosaccharides as a white solid (10.9 mg, three

steps yield: 62%).  $^1\text{H}$  NMR (400 MHz, D<sub>2</sub>O, HH-COSY, HSQC):  $\delta$

5.06 – 4.95 (bs, 1H, H-1<sub>Gul</sub>), 4.71 (d,  $J = 1.9$  Hz, 1H, H-4<sub>Gul</sub>), 4.66

(bs, 1H, H-1<sub>Mann</sub>), 4.15 (bs, 1H, H-3<sub>Gul</sub>), 3.98 – 3.84 (m, 4H, H-

2<sub>Gul</sub>, H-2<sub>Mann</sub>, H-5<sub>Gul</sub>, -OCH<sub>2</sub>CH<sub>2</sub>CH<sub>2</sub>NHAc), 3.81 – 3.59 (m, 4H, H-5<sub>Mann</sub>, H-4<sub>Mann</sub>, H-3<sub>Mann</sub>, -OCH<sub>2</sub>CH<sub>2</sub>CH<sub>2</sub>NHAc), 3.37 –

## Chapter 4

3.11 (m, 2H,  $-\text{OCH}_2\text{CH}_2\text{CH}_2\text{NHAc}$ ), 1.95 (s, 3H,  $\text{CH}_3\text{CO}$ ), 1.78 (t,  $J = 6.4$  Hz, 2H,  $-\text{OCH}_2\text{CH}_2\text{CH}_2\text{NHAc}$ );  $^{13}\text{C}$ -APT NMR ( $\text{D}_2\text{O}$ , 100 MHz, HSQC):  $\delta$  176.1, 175.7, 174.0 ( $-\text{CO}-$ ), 99.7 (C-1<sub>Mann</sub>), 99.5 (C-1<sub>Gul</sub>), 77.8 (C-4<sub>Mann</sub>), 75.8 (C-5<sub>Mann</sub>), 71.9 (C-3<sub>Mann</sub>), 70.8 (C-3<sub>Gul</sub>), 70.6 (C-2<sub>Mann</sub>), 70.3 (C-5<sub>Gul</sub>), 68.0 (C-4<sub>Gul</sub>), 67.2 ( $-\text{OCH}_2\text{CH}_2\text{CH}_2\text{NHAc}$ ), 64.7 (C-2<sub>Gul</sub>), 36.2 ( $-\text{OCH}_2\text{CH}_2\text{CH}_2\text{NHAc}$ ), 28.1 ( $-\text{OCH}_2\text{CH}_2\text{CH}_2\text{NHAc}$ ), 21.8 ( $\text{CH}_3\text{CO}$ );  $^{13}\text{C}$ -HMBC ( $\text{CDCl}_3$ , 100 MHz): 99.7 ( $J_{\text{C}1,\text{H}1} = 160\text{Hz}$ , C-1<sub>Mann</sub>), 99.5 ( $J_{\text{C}1,\text{H}1} = 170$ , C-1<sub>Gul</sub>). HR-MS:  $[\text{M}+\text{H}^+]$  Calculated for  $\text{C}_{17}\text{H}_{27}\text{O}_{14}\text{N}$ : 470.15043; found: 470.15015.

**26-Na<sup>+</sup>**: 82 mg, yield: 74%.  $^1\text{H}$  NMR (600 MHz,  $\text{D}_2\text{O}$ )  $\delta$  5.16 – 5.13 (m, 1H), 4.83 (d,  $J = 1.9$  Hz, 1H), 4.81 (d,  $J = 1.1$  Hz, 1H), 4.30 (t,  $J = 1.7$  Hz, 1H), 4.11 (dd,  $J = 3.1$ , 1.0 Hz, 1H), 4.09 – 4.06 (m,

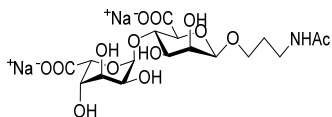

2H), 4.06 – 4.01 (m, 1H), 3.94 – 3.91 (m, 2H), 3.91 – 3.87 (m, 1H), 3.84 – 3.79 (m, 1H), 3.47 – 3.41 (m, 1H), 3.38–3.33 (m, 1H), 2.10 (s, 3H), 1.93 (m, 2H);  $^{13}\text{C}$  NMR (151 MHz,  $\text{D}_2\text{O}$ )  $\delta$  177.3, 176.8, 175.1, 100.72, 100.67,

79.0, 76.9, 73.0, 71.8, 71.6, 71.3, 69.1, 68.2, 65.8, 37.2, 29.2, 22.9.

### Trisaccharide 29

**29-NH<sub>4</sub><sup>+</sup>**: was obtained as described the general procedure for saponification, high pressure hydrogenation and

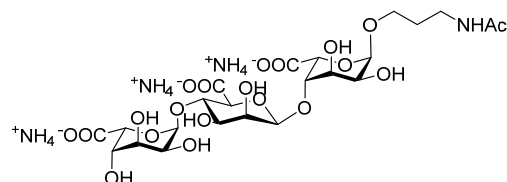

acetylation of oligosaccharides as a white solid (9.6 mg, three steps yield: 43%).  $^1\text{H}$  NMR (400 MHz,  $\text{D}_2\text{O}$ , HH-COSY, HSQC):  $\delta$  4.96 (bs, 1H, H-1<sub>Gul</sub>), 4.90 (d,  $J = 4.3$  Hz, 1H, H-1<sub>Gul</sub>), 4.68 (d,  $J = 4.5$  Hz, 2H, H-1<sub>Mann</sub>, H-4<sub>Gul</sub>), 4.42 (d,  $J = 1.6$  Hz, 1H, H-5<sub>Gul</sub>), 4.25 – 4.08 (m,

3H, H-3<sub>Gul</sub>, H-4<sub>Gul</sub>, H-3<sub>Gul</sub>), 3.99 (t,  $J = 3.9$  Hz, 1H, H-2<sub>Gul</sub>), 3.89 (d,  $J = 3.4$  Hz, 3H, H-2<sub>Mann</sub>, H-5<sub>Gul</sub>, H-2<sub>Gul</sub>), 3.81 – 3.66 (m, 4H, H-5<sub>Mann</sub>, H-4<sub>Mann</sub>, H-3<sub>Mann</sub>,  $-\text{OCH}_2\text{CH}_2\text{CH}_2\text{NHAc}$ ), 3.52 (m, 1H,  $-\text{OCH}_2\text{CH}_2\text{CH}_2\text{NHAc}$ ), 3.34 – 3.08 (m, 2H,  $-\text{OCH}_2\text{CH}_2\text{CH}_2\text{NHAc}$ ), 1.93 (s, 3H,  $\text{CH}_3\text{CO}$ ), 1.79 (dt,  $J = 7.8$ , 3.6 Hz, 2H,  $-\text{OCH}_2\text{CH}_2\text{CH}_2\text{NHAc}$ );  $^{13}\text{C}$ -APT NMR ( $\text{D}_2\text{O}$ , 100 MHz, HSQC):  $\delta$  176.2, 175.9, 175.7, 174.0 ( $-\text{CO}-$ ), 101.2 (C-1<sub>Mann</sub>), 99.5 (C-1<sub>Gul</sub>), 98.7 (C-1<sub>Gul</sub>), 80.4 (C-4<sub>Gul</sub>), 77.5 (C-4<sub>Mann</sub>), 75.8 (C-5<sub>Mann</sub>), 71.5 (C-3<sub>Mann</sub>), 70.8 (C-3<sub>Gul</sub>), 70.7, 70.4 (C-5<sub>Gul</sub>, C-2<sub>Mann</sub>), 69.50 (C-3<sub>Gul</sub>), 68.0 (C-4<sub>Gul</sub>), 66.9 ( $-\text{OCH}_2\text{CH}_2\text{CH}_2\text{NHAc}$ ), 66.70 (C-5<sub>Gul</sub>), 64.7 (C-2<sub>Gul</sub>), 64.4 (C-2<sub>Gul</sub>), 36.9 ( $-\text{OCH}_2\text{CH}_2\text{CH}_2\text{NHAc}$ ), 27.9 ( $-\text{OCH}_2\text{CH}_2\text{CH}_2\text{NHAc}$ ), 21.8 ( $\text{CH}_3\text{CO}$ );  $^{13}\text{C}$ -HMBC ( $\text{CDCl}_3$ , 100 MHz): 101.2 ( $J_{\text{C}1,\text{H}1} = 161\text{Hz}$ , C-1<sub>Mann</sub>), 99.5 ( $J_{\text{C}1,\text{H}1} = 171\text{Hz}$ , C-1<sub>Gul</sub>), 98.7 ( $J_{\text{C}1,\text{H}1} = 170\text{Hz}$ , C-1<sub>Gul</sub>). HR-MS:  $[\text{M}+\text{H}^+]$  Calculated for  $\text{C}_{23}\text{H}_{35}\text{O}_{20}\text{N}$ : 646.18252; found: 646.18250.

**29-Na<sup>+</sup>**: 10.9 mg, yield: quantitative.  $^1\text{H}$  NMR (600 MHz,  $\text{D}_2\text{O}$ )  $\delta$  5.16 – 5.13 (m, 1H), 5.07 (d,  $J = 3.9$  Hz, 1H), 4.84

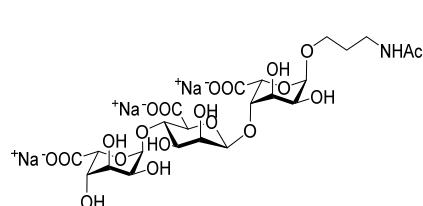

(dd,  $J = 6.1$ , 1.4 Hz, 1H), 4.58 (d,  $J = 1.7$  Hz, 1H), 4.38–4.36 (m, 1H), 4.33 (m, 1H), 4.32 – 4.27 (m, 1H), 4.17 (t,  $J = 3.9$  Hz, 1H), 4.09 – 4.04 (m, 3H), 3.97 – 3.85 (m, 4H), 3.69 (m, 1H), 3.48 – 3.33 (m, 2H), 2.10 (s, 3H), 1.96 (m, 2H);  $^{13}\text{C}$  NMR (151 MHz,  $\text{D}_2\text{O}$ )  $\delta$  177.3, 177.0, 176.8, 175.0, 102.3, 100.6, 99.7, 81.5,

78.6, 76.9, 72.5, 71.8, 71.7, 71.4, 70.6, 69.1, 68.0, 67.7, 65.8, 65.4, 38.0, 29.0, 22.8.

### Tetrasaccharide 27

**27-NH<sub>4</sub><sup>+</sup>** was obtained as described by the general procedure for saponification, high pressure hydrogenation and

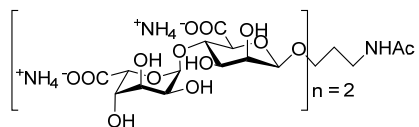

acetylation of oligosaccharides as a white solid (10.6 mg, three

steps yield: 51%). <sup>1</sup>H NMR (400 MHz, D<sub>2</sub>O, HH-COSY, HSQC): δ 5.03 (m, 2H, H-1<sub>Gul</sub>, H-1<sub>Gul</sub>), 4.84(bs, 1H, H-4<sub>Gul</sub>), 4.82 (bs, 1H, H-5<sub>Gul</sub>), 4.71 (bs, 1H, H-1<sub>Mann</sub>), 4.68 (bs, 1H, H-1<sub>Mann</sub>), 4.27 – 4.20

(m, 1H, H-4<sub>Gul</sub>), 4.18 (m, 2H, H-3<sub>Gul</sub>, H-3<sub>Gul</sub>), 4.02 – 3.72 (m, 12H, H-5<sub>Gul</sub>, H-2<sub>Gul</sub>, H-2<sub>Gul</sub>, H-2<sub>Mann</sub>, H-2<sub>Mann</sub>, H-3<sub>Mann</sub>, H-3<sub>Mann</sub>, H-4<sub>Mann</sub>, H-4<sub>Mann</sub>, H-5<sub>Mann</sub>, H-5<sub>Mann</sub>, -OCH<sub>2</sub>CH<sub>2</sub>CH<sub>2</sub>NHAc), 3.70 – 3.59 (m, 1H, -OCH<sub>2</sub>CH<sub>2</sub>CH<sub>2</sub>NHAc), 3.34 – 3.12 (m, 2H, -OCH<sub>2</sub>CH<sub>2</sub>CH<sub>2</sub>NHAc), 1.96 (s, 3H, CH<sub>3</sub>CO), 1.79 (q, *J* = 6.5 Hz, 2H, -OCH<sub>2</sub>CH<sub>2</sub>CH<sub>2</sub>NHAc); <sup>13</sup>C –APT NMR (D<sub>2</sub>O, 100 MHz, HSQC): δ 175.2, 174.8, 174.0(-CO-), 101.2, 99.8(C-1<sub>Mann</sub>, C-1<sub>Mann</sub>), 99.4(C-1<sub>Gul</sub>, C-1<sub>Gul</sub>), 79.9(C-4<sub>Gul</sub>), 77.4, 77.3 (C-4<sub>Mann</sub>, C-4<sub>Mann</sub>), 75.4, 75.3(C-5<sub>Mann</sub>, C-5<sub>Mann</sub>), 71.7, 71.3(C-3<sub>Mann</sub>, C-3<sub>Mann</sub>), 70.7, 70.6, 70.2, 69.1 (C-3<sub>Gul</sub>, C-2<sub>Mann</sub>, C-2<sub>Mann</sub>, C-3<sub>Gul</sub>), 67.6, 67.1(C-5<sub>Gul</sub>, C-4<sub>Gul</sub>), 67.2(-OCH<sub>2</sub>CH<sub>2</sub>CH<sub>2</sub>NHAc), 64.6(C-2<sub>Gul</sub>, C-2<sub>Gul</sub>), 36.2(-OCH<sub>2</sub>CH<sub>2</sub>CH<sub>2</sub>NHAc), 28.1(-OCH<sub>2</sub>CH<sub>2</sub>CH<sub>2</sub>NHAc), 21.8(CH<sub>3</sub>CO); <sup>13</sup>C-HMBC (CDCl<sub>3</sub>, 100 MHz): 101.2, 99.8(*J*<sub>C1,H1</sub> = 161Hz, *J*<sub>C1,H1</sub> = 160Hz, C-1<sub>Mann</sub>, C-1<sub>Mann</sub>), 99.4(*J*<sub>C1,H1</sub> = 171Hz, *J*<sub>C1,H1</sub> = 170Hz, 2x C-1<sub>Gul</sub>). HR-MS: [M+H<sup>+</sup>] Calculated for C<sub>29</sub>H<sub>43</sub>O<sub>26</sub>N: 822.21461; found: 822.21521.

**27-Na<sup>+</sup>**: 10.6 mg, yield: 98%. <sup>1</sup>H NMR (600 MHz, D<sub>2</sub>O) δ 5.16 (d, *J* = 3.8 Hz, 1H), 5.15 – 5.13 (m, 1H), 4.84 – 4.79 (m, 2H), 4.33 (m, 2H), 4.31 – 4.28 (m, 1H), 4.12 (t, *J* = 3.9 Hz, 1H),

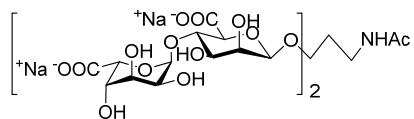

4.09 (dd, *J* = 3.2, 1.0 Hz, 1H), 4.08 – 4.01 (m, 5H), 3.94 – 3.84 (m, 7H), 3.81 (m, 1H), 3.39 (m, 3H), 2.10 (s, 3H), 1.93 (p, *J* = 6.5 Hz, 2H); <sup>13</sup>C NMR (151 MHz, D<sub>2</sub>O) δ 177.3, 176.9, 175.1, 102.2,

100.7, 100.6, 81.0, 78.7, 77.0, 76.9, 72.9, 72.6, 71.8, 71.7, 71.4, 70.2, 69.1, 68.5, 68.2, 65.8, 65.7, 37.2, 29.2, 22.9.

### Pentasaccharide 30

**30-NH<sub>4</sub><sup>+</sup>** was obtained as described by the general procedure for saponification, high pressure hydrogenation and

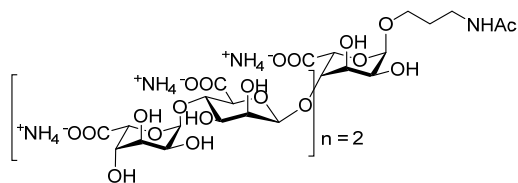

acetylation of oligosaccharides as a white solid (8.4

mg, three steps yield: 77%). <sup>1</sup>H NMR (400 MHz, D<sub>2</sub>O, HH-COSY, HSQC): δ 5.02-5.00 (m, 2H, H-1<sub>Gul</sub>, H-1<sub>Gul</sub>), 4.93 (d, *J* = 3.9 Hz, 1H, H-1<sub>Gul</sub>), 4.75 (d, *J* = 1.9 Hz, 1H, H-5<sub>Gul</sub>), 4.71(bs, 1H, H-1<sub>Mann</sub>), 4.69 (bs, 1H,

H-1<sub>Mann</sub>), 4.46(bs, 1H, H-5<sub>Gul</sub>), 4.26 – 4.12 (m, 5H, H-4<sub>Gul</sub>, H-4<sub>Gul</sub>, H-3<sub>Gul</sub>, H-3<sub>Gul</sub>, H-3<sub>Gul</sub>), 4.02 (t, *J* = 3.9 Hz, 1H, H-2<sub>Gul</sub>), 3.97 (t, *J* = 3.9 Hz, 1H, H-2<sub>Gul</sub>), 3.94-3.90 (m, 4H, H-2<sub>Gul</sub>, H-5<sub>Gul</sub>, H-2<sub>Mann</sub>, H-2<sub>Mann</sub>), 3.84 – 3.69 (m, 7H, H-3<sub>Mann</sub>, H-3<sub>Mann</sub>, H-4<sub>Mann</sub>, H-4<sub>Mann</sub>, H-5<sub>Mann</sub>, H-5<sub>Mann</sub>, -OCH<sub>2</sub>CH<sub>2</sub>CH<sub>2</sub>NHAc), 3.55 (dt, *J* = 10.0, 5.8 Hz, 1H, -OCH<sub>2</sub>CH<sub>2</sub>CH<sub>2</sub>NHAc),

## Chapter 4

3.32 – 3.15 (m, 2H,  $-\text{OCH}_2\text{CH}_2\text{CH}_2\text{NHAc}$ ), 1.96 (s, 3H,  $\text{CH}_3\text{CONH}-$ ), 1.82 (td,  $J = 6.4, 2.4$  Hz, 2H,  $-\text{OCH}_2\text{CH}_2\text{CH}_2\text{NHAc}$ );  $^{13}\text{C}$  –APT NMR ( $\text{D}_2\text{O}$ , 100 MHz, HSQC):  $\delta$  175.8, 175.6, 175.6, 175.6, 174.0( $-\text{CO}-$ ), 101.3, 101.2( $\text{C}-1_{\text{Mann}}$ ,  $\text{C}-1_{\text{Mann}}$ ), 99.5, 99.4, 98.7( $\text{C}-1_{\text{Gul}}$ ,  $\text{C}-1_{\text{Gul}}$ ,  $\text{C}-1_{\text{Gul}}$ ), 80.4, 80.0( $\text{C}-4_{\text{Gul}}$ ,  $\text{C}-4_{\text{Gul}}$ ), 77.5, 77.1 ( $\text{C}-4_{\text{Mann}}$ ,  $\text{C}-4_{\text{Mann}}$ ), 75.8, 75.7( $\text{C}-5_{\text{Mann}}$ ,  $\text{C}-5_{\text{Mann}}$ ), 71.5, 71.4( $\text{C}-3_{\text{Mann}}$ ,  $\text{C}-3_{\text{Mann}}$ ), 70.8, 70.7, 70.7, 70.4, 69.5, 69.3( $\text{C}-5_{\text{Gul}}$ ,  $\text{C}-3_{\text{Gul}}$ ,  $\text{C}-3_{\text{Gul}}$ ,  $\text{C}-2_{\text{Mann}}$ ,  $\text{C}-2_{\text{Mann}}$ ,  $\text{C}-3_{\text{Gul}}$ ), 67.9( $\text{C}-4_{\text{Gul}}$ ), 67.3( $\text{C}-5_{\text{Gul}}$ ), 67.0( $-\text{OCH}_2\text{CH}_2\text{CH}_2\text{NHAc}$ ), 66.7( $\text{C}-5_{\text{Gul}}$ ), 64.7, 64.7, 64.4( $\text{C}-2_{\text{Gul}}$ ,  $\text{C}-2_{\text{Gul}}$ ,  $\text{C}-2_{\text{Gul}}$ ), 37.0( $-\text{OCH}_2\text{CH}_2\text{CH}_2\text{NHAc}$ ), 28.0( $-\text{OCH}_2\text{CH}_2\text{CH}_2\text{NHAc}$ ), 21.8( $\text{CH}_3\text{CO}$ );  $^{13}\text{C}$ -HMBC ( $\text{CDCl}_3$ , 100 MHz): 101.3, 101.2( $J_{\text{C}1,\text{H}1} = 160\text{Hz}$ ,  $J_{\text{C}1,\text{H}1} = 160\text{Hz}$ ,  $\text{C}-1_{\text{Mann}}$ ,  $\text{C}-1_{\text{Mann}}$ ), 99.5, 99.4, 98.7 ( $J_{\text{C}1,\text{H}1} = 170\text{Hz}$ ,  $J_{\text{C}1,\text{H}1} = 170\text{Hz}$ ,  $J_{\text{C}1,\text{H}1} = 170\text{Hz}$ ,  $3\times\text{C}-1_{\text{Gul}}$ ). HR-MS:  $[\text{M}+\text{H}^+]$  Calculated for  $\text{C}_{35}\text{H}_{51}\text{O}_{32}\text{N}$ : 998.24669; found: 998.24784.

**30-Na<sup>+</sup>**: 8.4 mg, yield: 98%.  $^1\text{H}$  NMR (600 MHz,  $\text{D}_2\text{O}$ )  $\delta$  5.17 – 5.12 (m, 2H), 5.07 (d,  $J = 3.9$  Hz, 1H), 4.86 – 4.81 (m, 2H), 4.58 (d,  $J = 1.7$  Hz, 1H), 4.37 (td,  $J = 3.9, 1.2$  Hz, 1H), 4.33 (ddd,  $J = 10.1, 4.8, 2.8$  Hz, 3H), 4.30 – 4.27 (m, 1H), 4.16 (t,  $J = 3.9$  Hz, 1H), 4.11 (t,  $J = 3.9$  Hz, 1H), 4.09 – 4.03 (m, 4H), 3.96 – 3.84 (m, 7H), 3.69 (m, 1H), 3.40 (m, 2H), 2.10 (s, 3H), 1.96 (m, 2H);  $^{13}\text{C}$  NMR (151 MHz,  $\text{D}_2\text{O}$ )  $\delta$  177.3, 176.9, 176.9, 176.9, 176.8, 175.0, 102.3, 102.2, 100.6, 100.5, 99.7, 81.5, 81.0, 78.7, 78.3, 77.0, 76.9, 72.6, 72.5, 71.8, 71.7, 71.4, 70.6, 70.3, 69.1, 68.4, 68.0, 67.8, 65.8, 65.7, 65.4, 38.0, 28.9, 22.8.

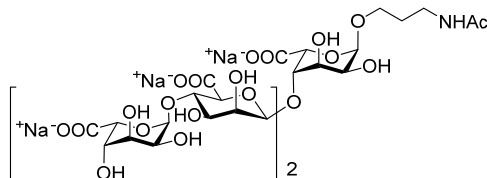

### Hexasaccharide 28

**28-NH<sub>4</sub><sup>+</sup>** was obtained as described by the general procedure for saponification, high pressure hydrogenation and acetylation of oligosaccharides as a white solid (8.6 mg, three steps yield: 54%).  $^1\text{H}$  NMR (850 MHz,  $\text{D}_2\text{O}$ , HH-COSY, HSQC):  $\delta$  5.11 – 4.95 (m, 3H,  $3\times\text{H}-1_{\text{Gul}}$ ), 4.91 – 4.82 (m, 3H,  $\text{H}-4_{\text{Gul}}$ ,  $\text{H}-5_{\text{Gul}}$ ,  $\text{H}-5_{\text{Gul}}$ ), 4.72(bs, 1H,  $\text{H}-1_{\text{Mann}}$ ), 4.71(bs, 1H,  $\text{H}-1_{\text{Mann}}$ ), 4.67(bs, 1H,  $\text{H}-1_{\text{Mann}}$ ), 4.31 – 4.12 (m, 5H,  $\text{H}-4_{\text{Gul}}$ ,  $\text{H}-4_{\text{Gul}}$ ,  $3\times\text{H}-3_{\text{Gul}}$ ), 3.98 – 3.84 (m, 10H,  $3\times\text{H}-2_{\text{Gul}}$ ,  $3\times\text{H}-2_{\text{Mann}}$ ,  $3\times\text{H}-174.27878$ ; found: 1174.280-5 $_{\text{Mann}}$ ,  $-\text{OCH}_2\text{CH}_2\text{CH}_2\text{NHAc}$ ), 3.84 – 3.72(m, 6H,  $3\times\text{H}-4_{\text{Mann}}$ ,  $3\times\text{H}-3_{\text{Mann}}$ ), 3.66 (m, 1H,  $-\text{OCH}_2\text{CH}_2\text{CH}_2\text{NHAc}$ ), 3.28 (dt,  $J = 13.4, 6.7$  Hz, 1H,  $-\text{OCH}_2\text{CH}_2\text{CH}_2\text{NHAc}$ ), 3.24 – 3.13 (m, 1H,  $-\text{OCH}_2\text{CH}_2\text{CH}_2\text{NHAc}$ ), 1.95(s, 3H,  $\text{CH}_3\text{CONH}-$ ), 1.77 (t,  $J = 6.5$  Hz, 2H,  $-\text{OCH}_2\text{CH}_2\text{CH}_2\text{NHAc}$ );  $^{13}\text{C}$  NMR (214 MHz,  $\text{D}_2\text{O}$ )  $\delta$  175.8, 175.5, 175.4, 175.0( $-\text{COO}-$ ), 102.3, 102.3, 100.9( $3\times\text{C}-1_{\text{Mann}}$ ), 100.4, 100.4( $3\times\text{C}-1_{\text{Gul}}$ ), 80.8, 80.8( $\text{C}-4_{\text{Gul}}$ ,  $\text{C}-4_{\text{Gul}}$ ), 78.3, 78.2, 77.9( $3\times\text{C}-4_{\text{Mann}}$ ), 76.1, 76.1, 76.0( $3\times\text{C}-5_{\text{Mann}}$ ), 72.6, 72.2, 72.2( $3\times\text{C}-3_{\text{Mann}}$ ), 71.6, 71.6, 71.5, 71.1( $3\times\text{C}-2_{\text{Mann}}$ ,  $\text{C}-3_{\text{Gul}}$ ), 70.1, 70.0( $2\times\text{C}-3_{\text{Gul}}$ ), 68.4( $\text{C}-1_{\text{Gul}}$ ), 68.2( $-\text{OCH}_2\text{CH}_2\text{CH}_2\text{NHAc}$ ), 68.0, 68.0( $\text{C}-5_{\text{Gul}}$ ,  $\text{C}-5_{\text{Gul}}$ ), 65.5, 65.5( $3\times\text{C}-2_{\text{Gul}}$ ), 37.2( $-\text{OCH}_2\text{CH}_2\text{CH}_2\text{NHAc}$ ), 29.1( $-\text{OCH}_2\text{CH}_2\text{CH}_2\text{NHAc}$ ), 22.8( $\text{CH}_3\text{CO}$ );  $^{13}\text{C}$ -HMBC ( $\text{CDCl}_3$ , 214 MHz): 102.3, 102.3, 100.9 ( $J_{\text{C}1,\text{H}1} = 160\text{Hz}$ ,  $3\times\text{C}-1_{\text{Mann}}$ ), 100.5, 100.4, 100.4 ( $J_{\text{C}1,\text{H}1} = 170\text{Hz}$ ,  $3\times\text{C}-1_{\text{Gul}}$ ). HR-MS:  $[\text{M}+\text{H}^+]$  Calculated for  $\text{C}_{41}\text{H}_{59}\text{O}_{38}\text{N}$ : 1174.27878; found: 1174.28070.

## Total Synthesis of Alginate fragments

**28-Na<sup>+</sup>**: 8.2 mg, yield: 93%. <sup>1</sup>H NMR (600 MHz, D<sub>2</sub>O) δ 5.01 – 4.95 (m, 3H), 4.72 (dd, *J* = 4.2, 1.6 Hz, 2H), 4.69 – 4.63

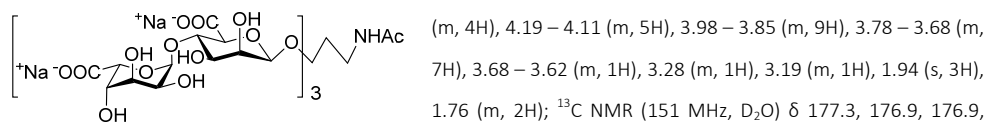

176.9, 176.8, 175.0, 102.2, 102.1, 100.7, 100.5, 100.5, 100.4, 81.0, 80.9, 78.6, 78.6, 78.3, 76.9, 76.9, 76.8, 72.9, 72.5, 72.4, 71.8, 71.7, 71.6, 71.4, 70.2, 70.1, 69.0, 68.4, 68.1, 65.7, 65.6, 37.1, 29.1, 22.8.

### Heptasaccharide 31

**31-NH<sub>4</sub><sup>+</sup>** was obtained as described by the general procedure for saponification, high pressure hydrogenation and

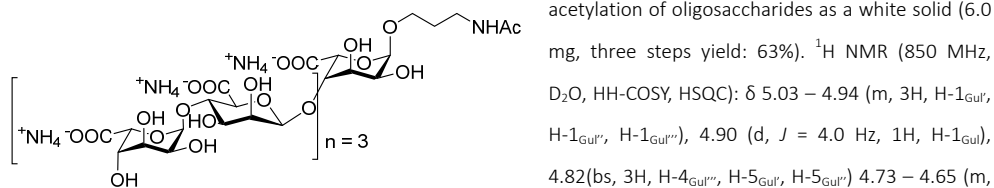

3H, H-1<sub>Mann'</sub>, H-1<sub>Mann''</sub>, H-1<sub>Mann'''</sub>), 4.49 (s, 1H, H-5<sub>Gul</sub>), 4.26 – 4.11 (m, 7H, H-4<sub>Gul</sub>, H-4<sub>Gul'</sub>, H-4<sub>Gul''</sub>, H-3<sub>Gul</sub>, H-3<sub>Gul'</sub>, H-3<sub>Gul''</sub>), 4.02 – 3.68 (m, 18H, 4 x H-2<sub>Gul</sub>, H-5<sub>Gul''</sub>, 3 x H-2<sub>Mann</sub>, 3 x H-3<sub>Mann</sub>, 3 x H-4<sub>Mann</sub>, 3 x H-5<sub>Mann</sub>, (-OCH<sub>2</sub>CH<sub>2</sub>CH<sub>2</sub>NHAc), 3.52 (m, 1H, (-OCH<sub>2</sub>CH<sub>2</sub>CH<sub>2</sub>NHAc), 3.47 – 3.40 (m, 1H), 3.27-3.19 (m, 2H, OCH<sub>2</sub>CH<sub>2</sub>CH<sub>2</sub>NHAc), 1.92 (s, 3H, CH<sub>3</sub>CO), 1.86 – 1.70 (m, 2H, -OCH<sub>2</sub>CH<sub>2</sub>CH<sub>2</sub>NHAc). <sup>13</sup>C –APT NMR (D<sub>2</sub>O, 214 MHz, HSQC): δ 176.1, 175.0(8x-COO-), 102.2(3xC-1<sub>Mann</sub>), 100.4, 99.7(4xC-1<sub>Gul</sub>), 81.3, 80.8(C-4<sub>Gul</sub>, C-4<sub>Gul'</sub>, C-4<sub>Gul''</sub>), 78.0(3xC-4<sub>Mann</sub>), 76.3(3xC-5<sub>Mann</sub>), 72.2(3xC-3<sub>Mann</sub>), 71.6, 71.2, 70.4, 70.1(3xC-2<sub>Mann</sub>, 4xC-3<sub>Gul</sub>, C-5<sub>Gul'''</sub>), 68.6(C-5<sub>Gul'</sub>, C-5<sub>Gul''</sub>), 68.1(C-4<sub>Gul'''</sub>), 68.0(-OCH<sub>2</sub>CH<sub>2</sub>CH<sub>2</sub>NHAc), 67.5(C-5<sub>Gul</sub>), 65.5, 65.3(4xC-2<sub>Gul</sub>), 37.9(-OCH<sub>2</sub>CH<sub>2</sub>CH<sub>2</sub>NHAc), 28.8(-OCH<sub>2</sub>CH<sub>2</sub>CH<sub>2</sub>NHAc), 22.7(CH<sub>3</sub>CO); <sup>13</sup>C-HMBC (CDCl<sub>3</sub>, 214 MHz): 102.4, 102.3, 102.2 (*J*<sub>C1,H1</sub> = 161Hz, 3xC-1<sub>Mann</sub>), 100.4, 99.7 (*J*<sub>C1,H1</sub> = 170Hz, *J*<sub>C1,H1</sub> = 171Hz, 4xC-1<sub>Gul</sub>). HR-MS: [M+H]<sup>+</sup> Calculated for C<sub>47</sub>H<sub>67</sub>O<sub>44</sub>N: 1350.31087; found: 1350.31198.

**31-Na<sup>+</sup>**: 5.9 mg, yield: 96%. <sup>1</sup>H NMR (600 MHz, D<sub>2</sub>O) δ 5.17 – 5.12 (m, 3H), 5.07 (d, *J* = 3.5 Hz, 1H), 4.95-4.90(m, 3H),

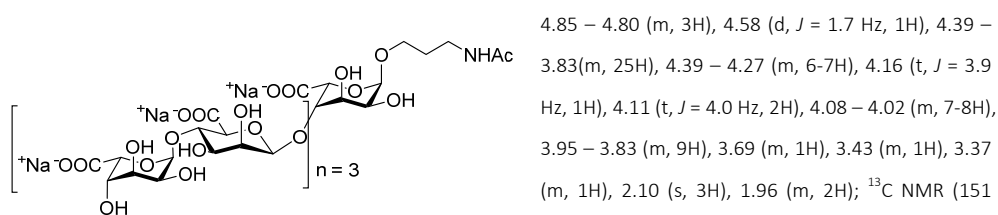

102.3, 102.2, 102.2, 100.6, 100.5, 100.5, 99.7, 81.5, 81.0, 81.0, 78.7, 78.4, 78.3, 77.0, 76.9, 72.6, 72.5, 72.5, 71.8, 71.8, 71.7, 71.4, 70.6, 70.3, 70.3, 69.1, 68.4, 68.0, 67.8, 65.8, 65.7, 65.4, 38.0, 28.9, 22.8.

## Chapter 4

### Hexasaccharide 32

**32-NH<sub>4</sub><sup>+</sup>**: (7.9 mg, three steps yield: 61%). HR-MS: [M+Na<sup>+</sup>] Calculated for C<sub>41</sub>H<sub>59</sub>NO<sub>38</sub>: 1196.22073; found:

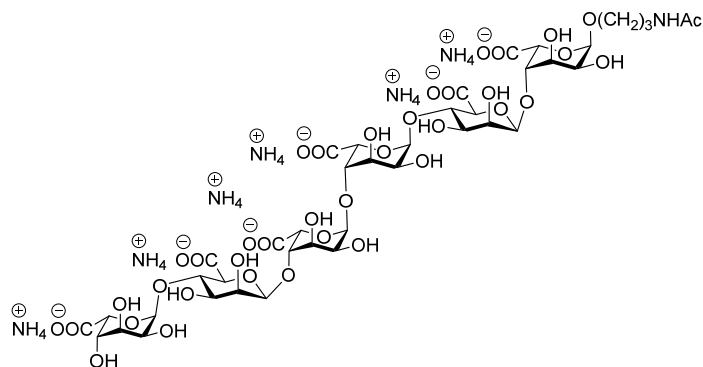

1196.26155. <sup>1</sup>H NMR (850 MHz, Deuterium Oxide) δ 5.00 (dd, *J* = 9.3, 4.5 Hz, 2H, H-1<sub>Gul</sub>, H-1<sub>Gul</sub>'), 4.98 – 4.94 (m, 1H, H-1<sub>Gul</sub>'), 4.91 (d, *J* = 4.0 Hz, 1H, H-1<sub>Gul</sub>'), 4.76 (d, *J* = 1.7 Hz, 1H, H-5<sub>Gul</sub>'), 4.70 – 4.63 (m, 4H, 2xH-1<sub>Mann</sub>, H-4<sub>Gul</sub>, H-5<sub>Gul</sub>'), 4.41 (dd, *J* = 7.5, 1.6 Hz, 2H, H-5<sub>Gul</sub>, H-5<sub>Gul</sub>'), 4.26 – 4.06 (m,

6H, H-3<sub>Gul</sub>, H-3<sub>Gul</sub>', H-3<sub>Gul</sub>''), H-4<sub>Gul</sub>, H-4<sub>Gul</sub>', H-4<sub>Gul</sub>''), 3.99 (t, *J* = 3.9 Hz, 1H, H-2<sub>Gul</sub>'), 3.95 (t, *J* = 3.8 Hz, 1H, H-3<sub>Gul</sub>'), 3.93 (d, *J* = 3.4 Hz, 1H, H-2<sub>Gul</sub>'), 3.91 – 3.89 (m, 4H, H-2<sub>Gul</sub>'', H-5<sub>Gul</sub>'', 2xH-2<sub>Mann</sub>), 3.88 (d, *J* = 4.0 Hz, 1H, H-2<sub>Gul</sub>'), 3.82 – 3.68 (m, 7H, 2xH-3<sub>Mann</sub>, 2xH-4<sub>Mann</sub>, 2xH-5<sub>Mann</sub>, -OCH<sub>2</sub>CH<sub>2</sub>CH<sub>2</sub>NHAc), 3.52 (dt, *J* = 10.3, 6.0 Hz, 1H, -OCH<sub>2</sub>CH<sub>2</sub>CH<sub>2</sub>NHAc), 3.30 – 3.24 (m, 1H, -OCH<sub>2</sub>CH<sub>2</sub>CH<sub>2</sub>NHAc), 3.25 – 3.15 (m, 1H, -OCH<sub>2</sub>CH<sub>2</sub>CH<sub>2</sub>NHAc), 1.94 (s, 3H, CH<sub>3</sub>CO), 1.80 (q, *J* = 7.2 Hz, 2H, -OCH<sub>2</sub>CH<sub>2</sub>CH<sub>2</sub>NHAc); <sup>13</sup>C NMR (213 MHz, D<sub>2</sub>O) δ 181.9, 177.3, 176.8, 176.8, 176.5, 175.0, 102.2, 102.1(2xC-1<sub>Mann</sub>), 101.7(C-1<sub>Gul</sub>'), 100.4(C-1<sub>Gul</sub>''), 100.3(C-1<sub>Gul</sub>''), 99.7(C-1<sub>Gul</sub>'), 81.5, 81.1(3xC-4<sub>Gul</sub>'), 78.3, 78.1(2xC-4<sub>Mann</sub>'), 76.9, 76.8(2xC-5<sub>Mann</sub>'), 72.4, 72.3(2xC-3<sub>Mann</sub>'), 71.8, 71.7, 71.7, 71.4(C-5<sub>Gul</sub>'', C-3<sub>Gul</sub>'), 70.5, 70.2, 70.1(3xC-5<sub>Gul</sub>'), 69.0(C-4<sub>Gul</sub>''), 68.3, 68.2(2xC-5<sub>Gul</sub>'), 67.9(-OCH<sub>2</sub>CH<sub>2</sub>CH<sub>2</sub>NHAc), 67.7(C-5<sub>Gul</sub>'), 65.9, 65.9, 65.7, 65.4(4xC-2<sub>Gul</sub>'), 37.9(-OCH<sub>2</sub>CH<sub>2</sub>CH<sub>2</sub>NHAc), 28.9(CH<sub>3</sub>CO), 22.8(-OCH<sub>2</sub>CH<sub>2</sub>CH<sub>2</sub>NHAc); <sup>13</sup>C-HMBC (CDCl<sub>3</sub>, 213 MHz): 102.2, 102.1(*J*<sub>C1,H1</sub> = 161Hz, 2xC-1<sub>Mann</sub>'), 101.7, 100.4, 100.3, 99.7 (*J*<sub>C1,H1</sub> = 170Hz, 4xC-1<sub>Gul</sub>').

**32-Na<sup>+</sup>**: 7.9 mg, 98%. <sup>1</sup>H NMR (600 MHz, D<sub>2</sub>O) δ 5.02 – 4.96 (m, 3H), 4.92 – 4.89 (m, 1H), 4.76 (d, *J* = 1.6 Hz, 1H),

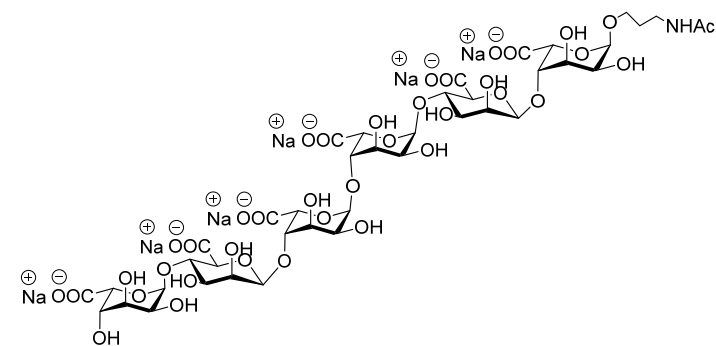

4.69 – 4.65 (m, 3H), 4.42 (d, *J* = 1.7 Hz, 2H), 4.40 (d, *J* = 1.7 Hz, 1H), 4.21 – 4.14 (m, 3H), 4.13 (dd, *J* = 3.4, 2.0 Hz, 1H), 4.08 (dd, *J* = 3.8, 1.7 Hz, 1H), 4.00 (t, *J* = 3.9 Hz, 1H), 3.98 – 3.93 (m, 1H), 3.92 – 3.87 (m, 7H), 3.80 – 3.69 (m, 6H), 3.53 (m, 1H), 3.24 (m,

2H), 1.94 (s, 3H), 1.80 (m, 2H); <sup>13</sup>C NMR (150 MHz, D<sub>2</sub>O) δ 177.3, 176.9, 176.9, 176.8, 176.5, 175.0, 102.2, 102.1, 101.8, 100.5, 100.4, 99.6, 81.4, 81.1, 81.0, 78.6, 78.2, 76.9, 76.8, 72.5, 72.3, 71.8, 71.8, 71.6, 71.4, 70.5, 70.0, 70.0,

69.0, 68.3, 68.1, 67.9, 67.7, 65.9, 65.7, 65.6, 65.4, 38.0, 28.9, 22.8;  $^{13}\text{C}$ -HMBC ( $\text{CDCl}_3$ , 150 MHz): 102.2, 102.1( $J_{\text{C1,H1}} = 160\text{Hz}$ ,  $2\times\text{C-1}_{\text{Mann}}$ ), 101.8( $J_{\text{C1,H1}} = 171\text{Hz}$ ,  $\text{C-1}_{\text{Gul}}$ ), 100.5, 100.4, 99.6( $J_{\text{C1,H1}} = 170\text{Hz}$ ,  $3\times\text{C-1}_{\text{Gul}}$ ).

## 4.5 references

- [1] Because of its polymeric nature, mixed sequence alginate can be described, arbitrarily, as being built up from -GM- or -MG- blocks.
- [2] a) T. H. Flo, L. Ryan, E. Latz, O. Takeuchi, B. G. Monks, E. Lien, Ø. Halaas, S. Akira, G. Skjåk-Bræk, D. T. Golenbock, T. Espevik, *J. Biol. Chem.*, **2002**, *277*, 35489-35495; b) B. H. A. Rehm, S. Valla, *Appl. Microbiol. Biotechnol.*, **1997**, *48*, 281-288.
- [3] a) S. T. Moe, K. I. Draget, G. Sjak-Bræk, O. Smidsrød, in *Food Polysaccharides and Their Applications*, (Ed: Stephen, A. M.); Marcel Dekker, Inc.; New York, **1995**, p. 245-286; b) J. Sun, H. Tan, *Materials*, **2013**, *6*, 1285-1309.
- [4] a) V. L. Campodónico, N. J. Llosa, L. V. Bentancor, T. Maira-Litran, G. B. Pier, *Infect. Immun.*, **2011**, *79*, 3455-3464; b) D. M. Ramsey, D. J. Wozniak, *Mol. Microbiol.*, **2005**, *56*, 309-322; c) M. Iwamoto, M. Kurachi, T. Nakashima, D. Kim, K. Yamaguchi, T. Oda, Y. Iwamoto, T. Muramatsu, *FEBS Lett.*, **2005**, *579*, 4423-4429.
- [5] a) F. Wolfram, E. N. Kitova, H. Robinson, M. T. C. Walvoort, J. D. C. Codée, J. S. Klassen, P. L. Howell, *J. Biol. Chem.*, **2014**, *289*, 6006-6019; b) P. Baker, T. Ricer, P. J. Moynihan, E. N. Kitova, M. T. C. Walvoort, D. Little, J. C. Whitney, K. Dawson, J. T. Weadge, H. Robinson, D. E. Ohman, J. D. C. Codée, J. S. Klassen, A. J. Clarke, P. L. Howell, *PLoS Pathog.*, **2014**, *10*, e1004334.
- [6] a) L. J. van den Bos, J. Dinkelaar, H. S. Overkleeft, G. A. van der Marel, *J. Am. Chem. Soc.*, **2006**, *128*, 13066-13067; b) J. D. C. Codée, L. J. van den Bos, A.R. de Jong, J. Dinkelaar, G. Lodder, H. S. Overkleeft, G. A. van der Marel, *J. Org. Chem.*, **2009**, *74*, 38-47; c) M. T. C. Walvoort, G. Lodder, J. Mazurek, H. S. Overkleeft, G. A. van der Marel, J. D. C. Codée *J. Am. Chem. Soc.*, **2009**, *131*, 12080-12081.
- [7] M. T. C. Walvoort, H. van den Elst, O. J. Plante, L. Kröck, P. H. Seeberger, H. S. Overkleeft, G. A. van der Marel, J. D. C. Codée, *Angew. Chem. Int. Ed. Engl.*, **2012**, *51*, 4393-4396.
- [8] J. Dinkelaar, L. J. van den Bos, W. F. J. Hogendorf, G. Lodder, H. S. Overkleeft, J. D. C. Codée, G. A. van der Marel, *Chem. Eur. J.*, **2008**, *14*, 9400-9411.
- [9] S.-C. Hung, F.-C. Chi, S. S. Kulkarni, M. M. L. Zulueta, *Chem. Asian. J.*, **2009**, *4*, 386-390.
- [10] J. Dinkelaar, A. R. de Jong, R. van Meer, M. Somers, G. Lodder, H. S. Overkleeft, J. D. C. Codée, G. A. van der Marel, *J. Org. Chem.*, **2009**, *74*, 4982-4991.
- [11] L. J. van den Bos, J. D. C. Codée, R. E. J. N. Litjens, J. Dinkelaar, H. S. Overkleeft, G. A. van der Marel, *Eur. J. Org. Chem.*, **2007**, 3963-3976.

## Chapter 4

---

- [12] In model experiments we have explored a range of orthogonally protected gulose acceptors. From these studies, it became clear that the reactivity of a guluronic acid methyl ester C4-OH is not significantly lower than that of a corresponding gulose C4-OH.
- [13] M. T. C. Walvoort, W. De Witte, J. Van Dijk, J. Dinkelaar, G. Lodder, J. Mazurek, H. S. Overkleef, G. A. van der Marel, J. D. C. Codée *Org. Lett.*, **2011**, *13*, 4360-4363.
- [14] In preliminary experiments evaluating reaction conditions to construct the ManA-Gul bond, TBSOTf proved to be more effective than TMSOTf and TfOH.
- [15] a) S. K. Mulani, W. -C. Hung, A. B. Ingle, K. -S. Shiau, K. -K. Tony Mong, *Org. Biomol. Chem.*, **2014**, *12*, 1184-1197; b) J. Park, S. Kawatkar, J. M. Kim, G. J. Boons, *Org. Lett.*, **2007**, *9*, 1959-1962.
- [16] J. Rönnols, M. T. C. Walvoort, G. A. van der Marel, J. D. C. Codée, G. Widmalm, *Org. Biomol. Chem.*, **2013**, *11*, 8127-8134.
- [17] We have not made an attempt to recover this lactol, but its identity was indicated by TLC-MS.
- [18] See, for example: a) D. Crich, A. U. Vinod, *J. Org. Chem.*, **2004**, *70*, 1291-1296; b) H. A. Orgueira, A. Bartolozzi, P. Schell, P. H. Seeberger, *Angew. Chem., Int. Ed.*, **2002**, *41*, 2128-2131; c) D. Crich, V. Dudkin, *J. Am. Chem. Soc.*, **2001**, *123*, 6819-6825.



## Chemical Synthesis of Guanosine Diphosphate Mannuronic Acid (GDP-ManA) and its C-4-O-Methyl and C-4-deoxy Congeners

Published in: *Carbohydr. Res*, 2017, 450, 12-18.

### 5.1 Introduction

Alginates are linear anionic polysaccharides, produced by brown algae and bacteria such as *Pseudomonas aeruginosa*.<sup>[1-3]</sup> Algal derived alginates have been widely used in food, cosmetic and medical industries because of their gelling properties.<sup>[4-6]</sup> In algae, they can be found in the cell wall,<sup>[1-3]</sup> while *P. aeruginosa* employs alginate to create a biofilm to protect the bacterium from its environment.<sup>[7]</sup> Alginates are composed of (1-4)-linked  $\beta$ -D-mannuronic acid (ManA, M) and  $\alpha$ -L-guluronic acid (GulA, G) residues (See Figure 5.1),

which occur in poly-M, poly-G or alternating MG blocks. Algae produce all three types of alginate, whereas bacteria only produce poly-M and MG polymers.<sup>[8]</sup> The ManA-residues in these alginates can carry acetyl esters at the C-2 or C-3 positions.<sup>[8]</sup> The *P. aeruginosa* biomachinery used to construct alginate polysaccharides is schematically depicted in Figure 5.1. It comprises an ensemble of 10 proteins that together span the periplasmic space.<sup>[9-12]</sup> First, guanosine diphosphate mannuronic acid (GDP-ManA) is polymerized by the action of Alg8 to create a poly-ManA chain.<sup>[13]</sup> While this polysaccharide is transported through the periplasm, ManA residues can either be acetylated by the concerted action of Alg I, J, F and X,<sup>[14-16]</sup> or epimerized at C-5 by AlgG to create GULA residues.<sup>[17-21]</sup> Acetylation of GULA residues is not found, indicating that these modifications are mutually exclusive. Cleavage of the alginate chains is accomplished by AlgL.<sup>[22-25]</sup> The length and composition of the alginate chains dictate its properties and understanding and harnessing the biosynthesis enzymes may open the way for therapeutic intervention<sup>[26,27]</sup> as well as the generation of designer alginates with tailor made properties for medical applications.<sup>[28,29]</sup>

To be able to study the polymerase enzyme, Alg8, sufficient amounts of the GDP-ManA donor are required and therefore the development of an efficient route of synthesis for this mannuronic acid synthon was undertaken. Taking into account that ManA-polymerases may be used for the *in vitro* construction of alginate polysaccharides, it was reasoned that GDP-ManA donors that cannot be elongated at the C-4-OH, could potentially be used as “chain stoppers” to control the length of the growing alginate chain and thereby the properties of the polymer.<sup>[30]</sup> As potential capping GDP-ManA donors, it was therefore decided to target the C-4-OMe GDPManA **2** and C-4-deoxy GDP-ManA **3** alongside the natural donor GDP-ManA **1** (Scheme 5.1).

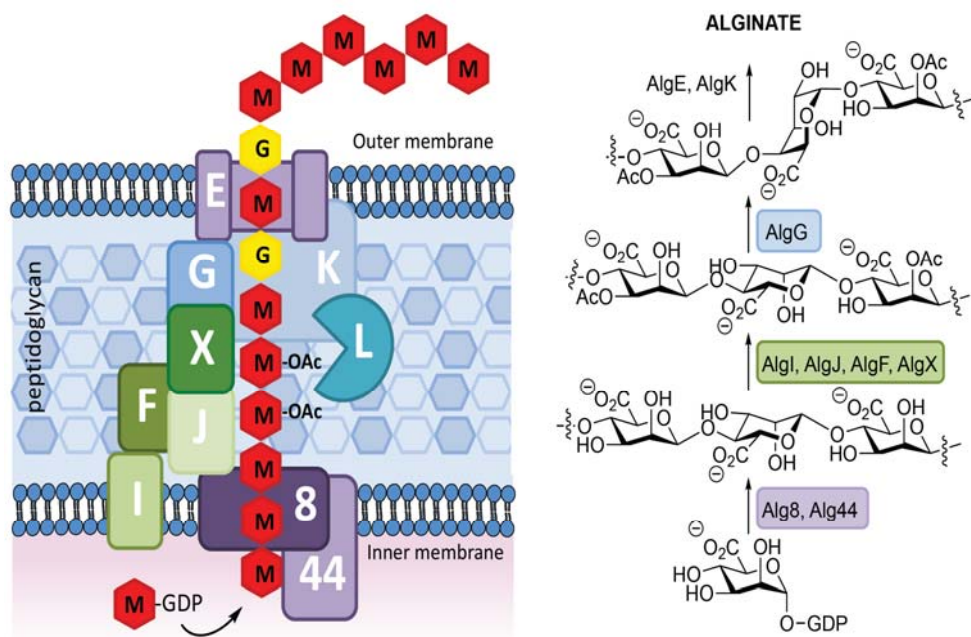
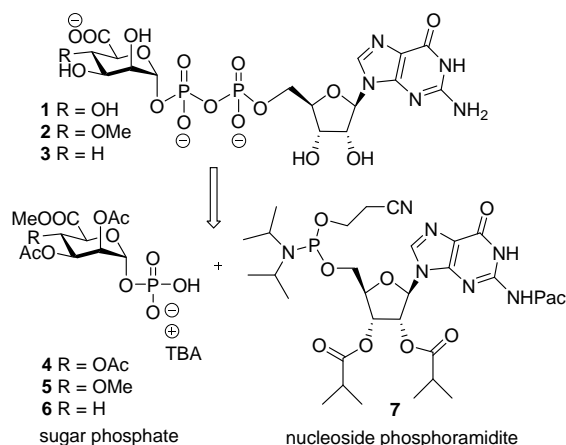

Figure 5.1 Biosynthesis of the alginate exopolysaccharide by *P. aeruginosa*.

The crucial synthetic step in the assembly of nucleotide diphosphate sugars is the union of the carbohydrate and the nucleoside through the construction of the pyrophosphate moiety. There are many different procedures reported to achieve the introduction of pyrophosphates<sup>[31,32]</sup> and the most commonly employed methods have in common the condensation of a phosphate monoester with an activated phosphate monoester.<sup>[31-39]</sup> It has been recently shown that the powerful phosphorylation capacity of phosphoramidites can be combined with phosphate monoesters for the effective construction of various types of pyrophosphate linkages.<sup>[40-44]</sup> Towards a nucleotide diphosphate sugar, a suitably protected sugar-1-phosphate is coupled to a nucleoside

phosphoramidite using an appropriate activator, such as dicyanoimidazole (DCI), to provide a phosphate-phosphite intermediate. This  $P^{(V)}$ - $P^{(III)}$  species can be oxidized to give the partially protected pyrophosphate.<sup>[40-44]</sup> This chapter describes the use of this method in the construction of GDP-ManA donors **1**, **2** and **3** (Scheme 5.1).

**Scheme 5.1** Retrosynthetic analysis towards target GDP-ManA compounds **1**, **2** and **3**.



## 5.2 Results and discussion

As retrosynthetically depicted in Scheme 5.1, three protected ManA-1-phosphates (**4-6**) and a protected guanosine cyanoethyl phosphoramidite (**7**) were required. The latter building block was assembled according to well-established procedures<sup>[45]</sup> and the synthesis of the protected ManA-phosphate donors is presented in Scheme 5.2. The anomeric phosphate group in these building blocks was stereoselectively introduced by coupling of the mannuronic acid thioglycosides with dibenzyl phosphate and subsequent removal of the benzyl groups. The assembly of the required mannuronic acid building blocks started from 2,3-di-acetyl-5-tolyl mannoside **8**<sup>[46]</sup> by a regio- and chemoselective oxidation step to furnish the 5-tolyl mannuronic acid.<sup>[47-51]</sup> The crude acid was immediately

esterified to give ManA methyl ester **9** in 68% over two steps. Acetylation of the remaining alcohol led to fully protected ManA **10**, while treatment of the alcohol with trimethylsilyldiazomethane and borontrifluoride-diethyl etherate provided the C-4-methyl ether **11** in 26% yield. Attempts to remove the alcohol group from **9** using a Barton-McCombie procedure failed, as the intermediate C-4-xanthate ester proved to be prone to elimination of the C-4-ester leading to the  $\alpha,\beta$ -unsaturated ManA ester.<sup>[52,53]</sup> Therefore it has been decided to install the C-5-carboxylate after deoxygenation of C-4. To this end, the C-6-alcohol in 2,3-di-acetyl-*S*-tolyl mannoside **8** was masked as a silyl ether, after which the xanthate ester was installed at C-4 and subsequent radical reduction led to C-4-deoxy mannose **13**. Silyl removal then liberated the primary alcohol, which was oxidized to the corresponding acid. Treatment of the crude acid with trimethylsilyldiazomethane then furnished C-4 deoxy ManA **15** in excellent yield (95% over two steps). The three *S*-tolyl mannuronic acids were coupled with dibenzyl phosphoric acid under the agency of *N*-iodosuccinimide (NIS) to stereoselectively provide the  $\alpha$ -ManA-phosphates **16**, **17** and **18** in good yields.<sup>[54]</sup> Cleavage of the benzyl esters through hydrogenation and treatment of the intermediate phosphate monoesters with tetrabutyl ammonium (TBA) hydroxide then gave the TBA-phosphates **4**, **5** and **6**, to be used in the crucial pyrophosphate forming step.

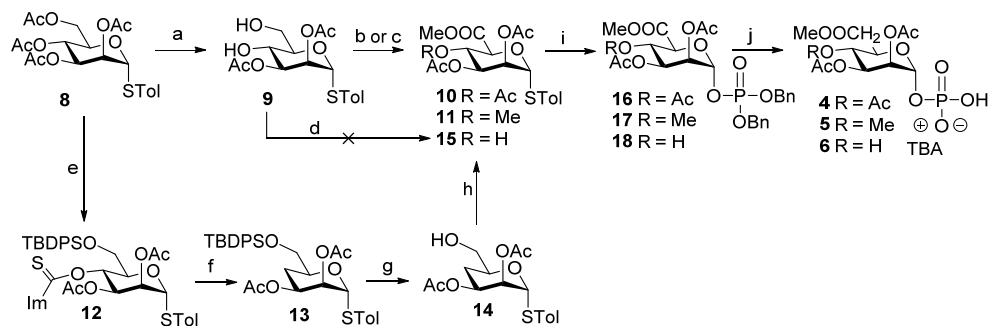
Scheme 5.2 Synthesis of ManA-1-phosphates **4**, **5** and **6**.

*Reagents and conditions:* a) i. TEMPO/BAIB, DCM/*t*BuOH/H<sub>2</sub>O, ii. MeI, K<sub>2</sub>CO<sub>3</sub>, DMF, two steps yield 68%; b) for **10**: Ac<sub>2</sub>O, pyridine, 88%, c) for **11**: trimethylsilyldiazomethane, BF<sub>3</sub>O•Et<sub>2</sub>, DCM, 26%; d) thiocarbonyldiimidazole, toluene, 90°C. e) i. TBDPSCl, imidazole, DMF, 93%; ii. thiocarbonyldiimidazole, toluene, 90°C, quantitative yield; f) AIBN, Bu<sub>3</sub>SnH, toluene, 90°C, 2 h, 84%; g) HF/Py, pyridine, THF, 99%; h) i. TEMPO/BAIB, DCM/*t*BuOH/H<sub>2</sub>O, ii. Trimethylsilyldiazomethane, DCM, MeOH, two steps yield 95%; i) dibenzylphosphate, NIS, DCM, **16**: 77%, **17**: 69%, **18**: 79%. j) i. H<sub>2</sub>, Pd/C, ii. tetrabutylammonium hydroxide, **4**: quantitative yield, **5**: 64%, **6**: 99%.

The assembly of the GDP-ManA pyrophosphates is depicted in Scheme 5.3. Tri-acetyl ManA phosphate **4** was coupled with protected guanosine phosphoramidite **7** under the agency of DCI to generate phosphate-phosphite adduct **19**. This species was oxidized in the same reaction flask with *tert*-butyl hydroperoxide (*t*BuOOH) to generate the pyrophosphate, of which the cyanoethyl group was removed using dry 1,5-diazabicyclo[4.3.0]non-5-ene (DBU) to give the pyrophosphate dianion. Initially we tried to saponify the methyl ester, three acetyl groups, two *iso*-butyl esters and phenoxyacetyl group using lithium hydroxide in a mixture of THF and water, but this led to cleavage of the anomeric phosphate ester to give guanosine diphosphate. We therefore switched to a milder saponification protocol using triethyl amine/water/methanol to remove all labile protecting groups. Gratifyingly, this procedure did not jeopardize the anomeric phosphate

## Guanosine Diphosphate Mannuronic Acid (GDP-ManA)

linkage and the GDP-ManA trisodium salt **1** could be obtained after ion exchange purification and Dowex- $\text{Na}^+$  treatment in 40% yield (from phosphoramidite **7**). Application of the same sequence of reactions to ManA-phosphates **5** and **6** furnished C-4-Methyl GDP ManA **2** in similar yield (45%) and C-4-deoxy GDP-ManA **3** in excellent yield (80%). All three syntheses could be accomplished on multi-milligram scale yielding 27, 42 and 53 mg of the target GDP-ManA donors **1**, **2** and **3** respectively.

**Scheme 5.3** Synthesis of GDP-ManA **1**, **2** and **3** using a phosphoramidite coupling approach.

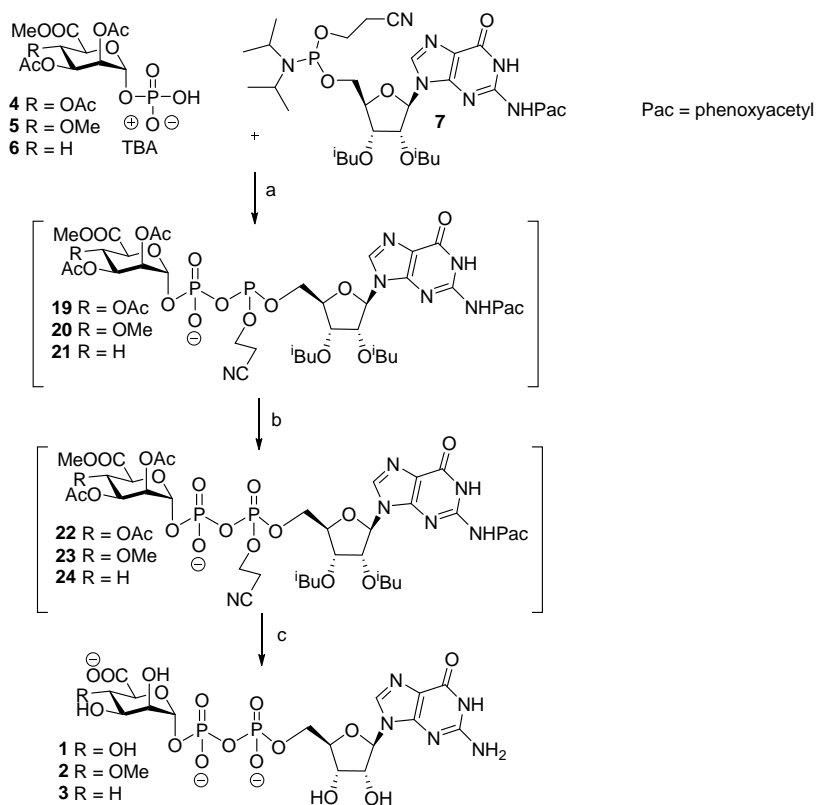

*Reagents and conditions:* a) dicyanoimidazole, **4**, **5** or **6**, MeCN, rt, 30 min; b)  $t\text{BuOOH}$ , rt, 30 min; c) i. DBU, 30 min, ii.  $\text{Et}_3\text{N}/\text{MeOH}/\text{H}_2\text{O}$ , rt, overnight, iii. ion-exchange purification, Dowex- $\text{Na}^+$ , lyophilization; **1**: 40%, **2**: 45%, **3**: 80% (from **7**).

### 5.3 Conclusion

In conclusion, the assembly of a triad of guanosine diphosphate mannuronic acids using a phosphoramidite coupling strategy was successfully completed. Key features in our syntheses are the chemo- and regioselective oxidation of a partially protected mannose thioglycoside to generate the corresponding mannuronic acids, the stereoselective introduction of the anomeric phosphates and the construction of the pyrophosphate moieties. The latter functionality was created by coupling the tetrabutylammonium ManA phosphates with a protected cyanoethyl guanosine phosphoramidite. Oxidation and global deprotection of the intermediates then effectively provided the target compounds that were each generated in multi-milligram quantities. The GDP-ManA donors will be employed to fuel the mannuronic polymerase for the enzymatic assembly of polymannuronic acids. The generated C-4-capped and C-4-deoxygenated GDP-ManA donors will be explored as “chain stoppers” to gain control over the length of the growing polymannuronic acid chains.

### 5.4 Experimental Section

#### General methods and materials

Commercially available reagents were used as received, except where noted. DCM and THF were dried over 4Å molecular sieves. Acetonitrile (DNA reagent grade) was stored over 4Å molecular sieves prior to use. Analytical TLC was performed on aluminium sheets, pre-coated with silica gel (Merck silica gel 60 F<sub>254</sub>) and visualized with UV or spraying with either 20% H<sub>2</sub>SO<sub>4</sub> in ethanol or Ammonium molybdate/Cerium sulphate solution [(NH<sub>4</sub>)<sub>6</sub>Mo<sub>7</sub>O<sub>24</sub>·4H<sub>2</sub>O (25 g/L), (NH<sub>4</sub>)<sub>4</sub>Ce(SO<sub>4</sub>)<sub>6</sub>·2H<sub>2</sub>O (10 g/L), 10% sulphuric acid in ethanol], followed by charring. <sup>1</sup>H, <sup>13</sup>C and <sup>31</sup>P NMR spectra were recorded on a 400MHz spectrometer at 400.2, 100.6 and 162.0 MHz respectively. Chemical shifts are reported as δ values (ppm) and directly referenced to TMS (0.00 ppm) in CDCl<sub>3</sub> or indirectly referenced to H<sub>3</sub>PO<sub>4</sub> (0.00 ppm) in D<sub>2</sub>O via the solvent residual signal. As a result of chair interconversion between the <sup>4</sup>C<sub>1</sub> and <sup>1</sup>C<sub>4</sub> conformers, the NMR spectra of the mannuronic acid esters show significant line broadening for some signals in the <sup>13</sup>C spectra, as well as <sup>3</sup>J coupling constants in the <sup>1</sup>H spectra that are an average of the <sup>3</sup>J coupling constants



## Guanosine Diphosphate Mannuronic Acid (GDP-ManA)

from both chair conformers [55-58]. The high resolution mass spectrometer was calibrated prior to measurements with a calibration mixture.

### **General experimental procedure for synthesis of D-mannopyranosyl uronate dibenzylphosphate **16**, **17** and **18**.**

After coevaporation with toluene three times, the thioglycoside donor **10**, **11** or **15** (2 mmol) and dibenzylphosphate (4 mmol) were dissolved in dry DCM (9 ml). NIS (3 mmol) and TfOH (0.28 mmol) were added to the reaction solution at 0 °C, the mixture was stirred for 1h and monitored by TLC analysis. The reaction mixture was quenched by the addition of 5% aq. Na<sub>2</sub>S<sub>2</sub>O<sub>3</sub>-solution (30 ml). The aqueous layer was separated and extracted with DCM. The combined organic layers were dried over Na<sub>2</sub>SO<sub>4</sub> and the solvent was removed *in vacuo*. Purification by column chromatography (silica gel, pentane/DCM/EtOAc, 3/1/1, v/v/v) yielded **16**, **17** or **18**.

### **General experimental procedure for synthesis of D-mannopyranosyl uronate phosphate, mono-tetrabutylammonium salt **4**, **5** and **6**.**

Dibenzylphosphotriester **16**, **17** or **18** (1 mmol) was dissolved in MeOH (10 ml) and purged with argon. Palladium on charcoal (Pd/C, 10%) (106 mg) was added and the reaction was purged with hydrogen gas and then stirred under a hydrogen atmosphere for 4 h at room temperature. The mixture was then filtered over Whatmann paper and the filter was rinsed with MeOH. Concentration of the organic solvent under reduced pressure followed by addition of 40% aq. solution of tetrabutylammonium hydroxide (0.67 ml, 1 mmol) and concentration afforded compound **4**, **5** or **6**.

### **General experimental procedure for synthesis of sugar nucleotides **1**, **2** and **3**.**

Phosphoramidite **7** (0.1 mmol, 1 eq) (coevaporated once with 5 mL anhydrous MeCN) was dissolved in 1.5 mL anhydrous MeCN under an atmosphere of argon. Sugar phosphate **4**, **5**, or **6** (0.12 mmol, 1.2 eq) and DCl (0.2 mmol, 2 eq) (coevaporated in 5 mL dry MeCN) were dissolved in 2 mL anhydrous MeCN and added to the phosphoramidite **7** at ambient temperature. The reaction mixture was stirred for 30 minutes at ambient temperature, after which t-BuOOH (80 ul, 0.4 mmol, 4 eq) was added. After 30 minutes of reaction time DBU (75 ul, 0.5 mmol, 5 eq) was added and the reaction was stirred for an additional 30 minutes. Et<sub>3</sub>N/MeOH/H<sub>2</sub>O (3 mL/3 mL/1.5 mL) was added and the reaction was stirred for overnight. The mixture was concentrated *in vacuo* at no more than 30 °C. The crude product was applied to a strong anion exchange column and eluted with a gradient of ammonium acetate [0.05M (pH 7.0) - 0.5M (pH 7.1)] at 4mL per minute. The fractions containing the product were collected and concentrated under reduced pressure. Repeated lyophilization (to remove residual ammonium acetate), followed by filtration over dowex-Na<sup>+</sup> form, produced the desired sugar nucleotides in good yields.

## Chapter 5

**Methyl (tolyl 2,3-di-O-acetyl -1-thio- $\alpha$ -D-mannopyranosyl uronate) (9):** The starting material **8** (2.93 g, 7.91 mmol)

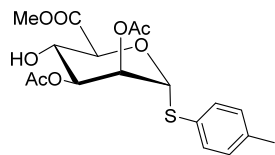

was dissolved in DCM/t-BuOH/H<sub>2</sub>O (54 ml, 4/4/1, v/v/v) and the mixture was cooled to 0 °C and treated with TEMPO (247 mg, 1.58 mmol) and BAIB (6.37 g, 19.77 mmol). After stirring overnight at 4 °C, sat. aq. Na<sub>2</sub>S<sub>2</sub>O<sub>3</sub> was added and the mixture was stirred for 30 minutes, diluted with EtOAc, washed with sat. aq.

NaCl and the organic phase was dried over Na<sub>2</sub>SO<sub>4</sub> and concentrated *in vacuo*. The crude residue was dissolved in DMF (20 ml), followed by the addition of K<sub>2</sub>CO<sub>3</sub> (1.09 g, 7.9 mmol) and MeI (0.98 ml, 15.82 mmol) at 0 °C. The mixture was allowed to stir overnight at 4 °C, and then diluted with EtOAc, washed with sat. aq. NaCl and the organic phase was dried over Na<sub>2</sub>SO<sub>4</sub> and concentrated *in vacuo*. Purification by column chromatography (silica gel, pentane/EtOAc, 2/1, v/v) yielded methyl ester **9** (2.13 g, yield: 68%). TLC: R<sub>f</sub> = 0.39 (pentane/EtOAc, 1/1, v/v); [α]<sup>20</sup><sub>D</sub> = +86° (c = 0.84, CHCl<sub>3</sub>). <sup>1</sup>H NMR (400 MHz, Chloroform-d) δ 7.39 (d, J = 8.2 Hz, 2H), 7.12 (d, J = 7.9 Hz, 2H), 5.46 (dd, J = 3.2, 2.3 Hz, 1H, H-2), 5.44 (d, J = 2.3 Hz, 1H, H-1), 5.21 (dd, J = 9.5, 3.3 Hz, 1H, H-3), 4.80 (d, J = 9.1 Hz, 1H, H-5), 4.27 (td, J = 9.4, 4.0 Hz, 1H, H-4), 3.83 (s, 3H), 3.54 (d, J = 4.1 Hz, 1H, C4-OH), 2.32 (s, 3H), 2.10 (s, 3H), 2.08 (s, 3H); <sup>13</sup>C NMR (101 MHz, CDCl<sub>3</sub>) δ 170.20, 169.93, 138.38, 132.56, 129.92, 128.75, 86.37 (C-1), 72.20 (C-5), 70.67 (C-3), 70.32 (C-2), 66.87 (C-4), 52.84, 21.08, 20.76, 20.74. HRMS: [M+H]<sup>+</sup> calculated for C<sub>18</sub>H<sub>22</sub>O<sub>8</sub>S: 399.11081; found: 399.11072.

**Methyl (tolyl 2,3,4-tri-O-acetyl -1-thio- $\alpha$ -D-mannopyranosyl uronate) (10):**

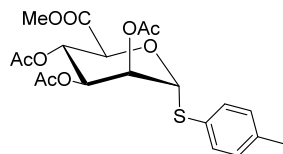

Compound **9** (1.95 g, 4.9 mmol) was dissolved in pyridine (5 ml) and Ac<sub>2</sub>O (1 ml) and DMAP (60 mg, 0.49 mmol) were added to the solution at 0 °C. Then the mixture was allowed to stir overnight at room temperature after which it was concentrated under reduced pressure. Purification by column chromatography (silica gel, pentane/EtOAc, 3/1, v/v) yielded **10** as a colourless foam (1.91 g, yield: 88%). TLC: R<sub>f</sub> = 0.47 (pentane/EtOAc, 2/1, v/v); [α]<sup>20</sup><sub>D</sub> = +78° (c = 1, CHCl<sub>3</sub>). <sup>1</sup>H NMR (400 MHz, Chloroform-d) δ 7.40 (d, J = 8.2 Hz, 2H), 7.20 – 7.06 (m, 2H), 5.52 (d, J = 3.7 Hz, 1H, H-1), 5.45 (m, J = 8.6 Hz, 1H, H-4), 5.42 (m, J = 3.5 Hz, 1H, H-2), 5.33 (dd, J = 8.7, 3.3 Hz, 1H, H-3), 4.81 (d, J = 8.1 Hz, 1H, H-5), 3.77 (s, 3H), 2.33 (s, 3H), 2.12 (s, 3H), 2.09 (s, 3H), 2.03 (s, 3H); <sup>13</sup>C NMR (101 MHz, CDCl<sub>3</sub>) δ 169.66, 167.99, 138.42, 132.41, 129.99, 128.55, 84.96 (C-1), 70.98 (C-5), 69.40 (C-2), 68.40 (C-3), 67.47 (C-4), 52.81, 21.16, 20.87, 20.73, 20.65. HRMS: [M+H]<sup>+</sup> calculated for C<sub>20</sub>H<sub>24</sub>O<sub>9</sub>S: 441.12138; found: 441.12148.

**Methyl (tolyl 2,3-di-O-acetyl -4-O-methyl-1-thio- $\alpha$ -D-mannopyranosyl urinate) (11):** Compound **9** (698 mg, 1.75

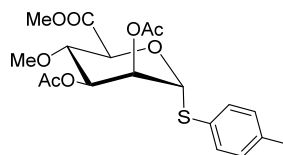

mmol) was dissolved in DCM (7.5 ml) and trimethylsilyldiazomethane (2.63 ml, 5.26 mmol, 2 M in hexane) and BF<sub>3</sub>•OEt<sub>2</sub> (0.63 ml, 5.25 mmol) were added to the solution in -40 °C. Then the mixture was allowed to stir for 2 h, after which additional trimethylsilyldiazomethane (2.63 ml, 5.26 mmol, 2 M in hexane) was

## Guanosine Diphosphate Mannuronic Acid (GDP-ManA)

added and stirred was continued for another 3 hours and quenched with AcOH (1 mL). The mixture was poured into 100 mL EtOAc and washed with sat. aq. NaHCO<sub>3</sub> and brine. The water layers were extracted with 100mL EtOAc and the combined organic layers were dried (Na<sub>2</sub>SO<sub>4</sub>) and concentrated *in vacuo*. Purification by column chromatography (10-20% EtOAc in petroleum ether) produced the title compound (187 mg, 0.45 mmol, yield: 26%). TLC: R<sub>f</sub> = 0.61 (pentane/EtOAc, 2/1, v/v); [α]<sub>D</sub><sup>20</sup> = +70° (c = 0.96, CHCl<sub>3</sub>). <sup>1</sup>H NMR (400 MHz, Chloroform-d) δ 7.42 (d, J = 8.3 Hz, 2H), 7.12 (d, J = 7.9 Hz, 3H), 5.44 (d, J = 4.2 Hz, 1H, H-1), 5.38 (dd, J = 4.2, 3.2 Hz, 1H, H-2), 5.26 (dd, J = 8.1, 3.2 Hz, 1H, H-3), 4.70 (d, J = 7.4 Hz, 1H, H-5), 3.91 (t, J = 7.8 Hz, 1H, H-4), 3.82 (s, 3H), 3.48 (s, 3H), 2.33 (s, 3H), 2.11 (s, 3H), 2.07 (s, 3H); <sup>13</sup>C NMR (101 MHz, CDCl<sub>3</sub>) δ 169.84, 169.58, 169.37, 138.30, 132.63, 129.94, 128.97, 85.04 (C-1), 76.08 (C-4), 72.18 (C-5), 70.44 (C-3), 69.58 (C-2), 59.84, 52.67, 21.23, 20.93. HRMS: [M+H]<sup>+</sup> calculated for C<sub>19</sub>H<sub>24</sub>O<sub>8</sub>S: 413.12646; found: 413.12648.

**Tolyl 2,3-di-O-acetyl-4-O-imidazole-thiocarbonyl-6-O-TBDPS-1-thio-α-D-mannopyranoside (12):** Compound **8** (1.384

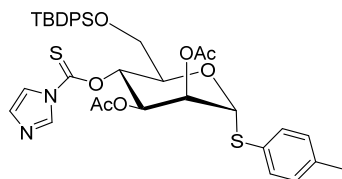

g, 3.74 mmol) and imidazole (0.51 g, 7.5 mmol) were dissolved in DMF (10 ml), then TBDPSCI (1.22 ml, 4.86 mmol) was added to the reaction mixture at 0 °C. The mixture was allowed to stir overnight at room temperature. The reaction was quenched with MeOH, then diluted with EtOAc and washed with sat. aq. NaHCO<sub>3</sub> and brine. The water layers

were extracted with EtOAc and the combined organic layers were dried (Na<sub>2</sub>SO<sub>4</sub>) and concentrated *in vacuo*. Purification by column chromatography (10-20% EtOAc in petroleum ether) produced tolyl 2,3-di-O-acetyl-6-O-TBDPS-1-thio-α-D-mannopyranoside (2.124 g, 3.49 mmol, yield: 93%). TLC: R<sub>f</sub> = 0.70 (pentane/EtOAc, 2/1, v/v). [α]<sub>D</sub><sup>20</sup> = +57° (c = 1, CHCl<sub>3</sub>). <sup>1</sup>H NMR (400 MHz, Chloroform-d) δ 7.70 – 7.67 (m, 4H), 7.53 – 7.32 (m, 6H), 7.30 (d, J = 8.1 Hz, 2H), 7.04 (d, J = 7.9 Hz, 2H), 5.48 (dd, J = 3.4, 1.6 Hz, 1H, H-2), 5.35 (d, J = 1.5 Hz, 1H, H-1), 5.19 (dd, J = 9.6, 3.3 Hz, 1H, H-3), 4.30 – 4.15 (m, 2H, H-5, H-4), 4.04 – 3.86 (m, 2H, H-6), 2.30 (s, 3H), 2.10 (s, 3H), 2.09 (s, 3H), 1.07 (s, 9H); <sup>13</sup>C NMR (101 MHz, CDCl<sub>3</sub>) δ 170.74, 170.09, 135.86, 135.66, 133.21, 132.80, 132.66, 129.97, 129.72, 127.94, 86.39 (C-1), 72.90 (C-5), 72.23 (C-3), 71.31 (C-2), 67.44 (C-4), 64.28 (C-6), 26.93, 21.26, 21.07, 20.97, 19.41. HRMS: [M+H]<sup>+</sup> calculated for C<sub>33</sub>H<sub>40</sub>O<sub>7</sub>Si: 609.23368; found: 609.23351. Then tolyl 2,3-di-O-acetyl-6-O-TBDPS-1-thio-α-D-mannopyranoside (1.82 g, 3 mmol) and thiocarbonyldiimidazole (0.896 g, 5.04 mmol) were dissolved in anhydrous toluene (30 ml) and the reaction mixture was allowed to stir for 7 h at 90 °C. After cooling to room temperature, the reaction mixture was washed with sat. aq. NaHCO<sub>3</sub> and brine. The organic layers were dried over Na<sub>2</sub>SO<sub>4</sub>, filtered and the solvent was removed *in vacuo*. Purification by column chromatography (silica gel, pentane/DCM/EtOAc, 4/1/1, v/v/v) yielded **12** (2.19 g, quantitative yield). TLC: R<sub>f</sub> = 0.36 (pentane/DCM/EtOAc, 3/1/1, v/v/v); [α]<sub>D</sub><sup>20</sup> = +63° (c = 1, CHCl<sub>3</sub>). <sup>1</sup>H NMR (400 MHz, Chloroform-d) δ 8.29 (t, J = 1.1 Hz, 1H), 7.68 – 7.54 (m, 5H), 7.43 – 7.33 (m, 4H), 7.33 – 7.23 (m, 5H), 7.11 – 7.03 (m, 3H), 6.34 (t, J = 9.5 Hz, 1H, H-4), 5.66 – 5.51 (m, 2H, H-3, H-2), 5.46 (d, J = 1.3 Hz, 1H, H-1), 4.55 (dt, J = 9.8, 3.2 Hz, 1H, H-5), 3.81 (d, J = 3.2 Hz, 2H, H-6), 2.33 (s, 3H), 2.16 (s, 3H), 1.96 (s, 3H), 1.03 (s, 9H); <sup>13</sup>C NMR (101 MHz, CDCl<sub>3</sub>) δ 182.95, 169.93, 169.79, 138.29, 135.79, 135.47,

## Chapter 5

133.07, 132.53, 132.35, 131.03, 130.01, 129.77, 129.20, 127.68, 127.57, 117.91, 86.06 (C-1), 75.27 (C-4), 71.89 (C-5), 71.43 (C-2), 69.46 (C-3), 62.37 (C-6), 26.70, 21.20, 20.89, 20.74, 19.22. HRMS:  $[M+H]^+$  calculated for  $C_{37}H_{42}N_2O_7Si$ : 719.22755; found: 719.22754.

### Tolyl 2,3-di-O-acetyl-4-deoxy-6-O-TBDPS-1-thio- $\alpha$ -D-mannopyranoside (**13**):

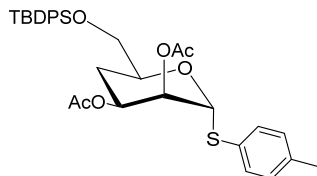

Barton-MaCombie precursor **12** (2.07 g, 2.88 mmol) was coevaporated with anhydrous toluene two times and was dissolved in anhydrous toluene (35 ml).  $Bu_3SnH$  (1.91 ml, 7.29 mmol) and AIBN (71 mg, 0.43 mmol) were added at 90 °C. The reaction was stirred at this temperature for 2 h and was then cooled down before being washed with sat. aq.  $NaHCO_3$  and

brine. The organic layers were dried over  $Na_2SO_4$ , filtrated and the solvent was removed in vacuo. Purification by column chromatography (silica gel, pentane/DCM/EtOAc, 6/1/1, v/v/v) yielded **13** (1.44 g, 2.43 mmol, yield: 84%).

TLC:  $R_f = 0.86$  (pentane/DCM/EtOAc, 3/1/1, v/v);  $[\alpha]_D^{20} = +72^\circ$  ( $c = 0.66$ ,  $CHCl_3$ ).  $^1H$  NMR (400 MHz, Chloroform- $d$ )  $\delta$  7.68 (dq,  $J = 7.0, 1.3$  Hz, 4H), 7.50 – 7.31 (m, 8H), 7.12 – 6.96 (m, 2H), 5.43 (d,  $J = 1.6$  Hz, 1H, H-1), 5.35 (brs, H-2), 5.25 (m, 1H, H-3), 4.46 (m, 1H, H-5), 3.84 – 3.64 (m, 2H, H-6), 2.29 (s, 3H), 2.10 (s, 3H), 2.04 (s, 3H), 2.03-1.85 (m, 2H, H-4), 1.07 (s, 9H);  $^{13}C$  NMR (101 MHz,  $CDCl_3$ )  $\delta$  170.14, 169.95, 137.75, 135.75, 135.60, 133.54, 133.21, 132.40, 130.17, 129.80, 129.71, 127.71, 127.68, 86.94 (C-1), 69.87 (C-2), 69.62 (C-5), 67.24 (C-3), 66.20 (C-6), 28.40 (C-4), 26.82, 21.14, 21.03, 20.97, 19.32. HRMS:  $[M+H]^+$  calculated for  $C_{33}H_{40}O_6Si$ : 593.23876; found: 593.23840.

### Tolyl 2,3-di-O-acetyl-4-deoxy-1-thio- $\alpha$ -D-mannopyranoside (**14**):

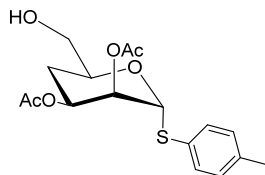

Compound **13** (1.38 g, 2.32 mmol) was dissolved in THF (6 ml) and pyridine (6 ml), and then HF/Py (70% HF in pyridine, 598  $\mu$ l, 23 mmol) was added to reaction mixture at 0 °C. The reaction mixture was allowed to stir at room temperature and monitored by TLC analysis. The reaction mixture was poured into a mixture of EtOAc and sat. aq.  $NaHCO_3$ . The organic layer was washed with bine, dried over  $Na_2SO_4$ , filtrated and the solvent was removed *in vacuo*. Purification by column chromatography (silica gel, pentane/ EtOAc, 2/1, v/v) yielded **14** (0.815 g, 2.3 mmol, yield: 99%).

TLC:  $R_f = 0.21$  (pentane/ EtOAc, 2/1, v/v);  $[\alpha]_D^{20} = +103^\circ$  ( $c = 0.88$ ,  $CHCl_3$ ).  $^1H$  NMR (400 MHz, Chloroform- $d$ )  $\delta$  7.45 – 7.35 (m, 2H), 7.14 (d,  $J = 7.9$  Hz, 2H), 5.44 (d,  $J = 1.7$  Hz, 1H, H-1), 5.38 (brs, 1H, H-2), 5.30 (m, 1H, H-3), 4.49 (m, 1H, H-5), 3.68 (m, 2H, H-6), 2.34 (s, 3H), 2.14 (s, 3H), 2.05 (s, 3H), 1.99 (q,  $J = 12.2$  Hz, 1H, H-4), 1.82 (m, 1H, H-4);  $^{13}C$  NMR (101 MHz,  $CDCl_3$ )  $\delta$  170.06, 169.92, 138.31, 132.99, 129.95, 129.30, 86.79 (C-1), 69.77 (C-2), 69.32 (C-5), 66.96 (C-3), 65.08 (C-6), 27.79 (C-4), 21.14, 20.94. HRMS:  $[M+H]^+$  calculated for  $C_{17}H_{22}O_6S$ : 355.12099; found: 355.12100.

## Guanosine Diphosphate Mannuronic Acid (GDP-ManA)

### Methyl (tolyl 2,3-di-O-acetyl-4-deoxy-1-thio- $\alpha$ -D-mannopyranosyl uronate) (15):

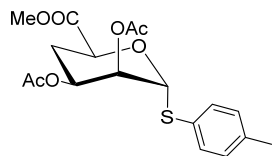

As described the synthesis of **9**, compound **15** was obtained (0.74 g, 1.94 mmol, yield: 95%). TLC:  $R_f$  = 0.26 (pentane/ EtOAc, 4/1, v/v);  $[\alpha]_D^{20}$  = +97° (c = 0.2, CHCl<sub>3</sub>). <sup>1</sup>H NMR (400 MHz, Chloroform-d)  $\delta$  7.42 – 7.32 (m, 2H), 7.11 (d, J = 7.9 Hz, 2H), 5.55 (d, J = 2.5 Hz, 1H, H-1), 5.26 (q, J = 4.6 Hz, 2H, H-2, H-3), 4.94 (dd, J = 10.5, 3.6 Hz, 1H, H-5), 3.79 (s, 3H), 2.32 (s, 3H), 2.30 – 2.14 (m, 2H, H-4), 2.11 (s, 3H), 2.04 (s, 3H); <sup>13</sup>C NMR (101 MHz, CDCl<sub>3</sub>)  $\delta$  170.28, 169.99, 169.72, 138.17, 132.32, 129.95, 129.16, 86.15 (C-1), 69.03 (C-2 or C-3), 68.35 (C-5), 66.59 (C-2 or C-3), 52.49, 29.14 (C-4), 21.14, 20.92, 20.88. HRMS: [M+H]<sup>+</sup> calculated for C<sub>18</sub>H<sub>22</sub>O<sub>7</sub>S: 383.11590; found: 383.11596.

### (Methyl 2,3,4-tri-O-acetyl- $\alpha$ -D-mannopyranosyl uronate) dibenzylphosphate (16):

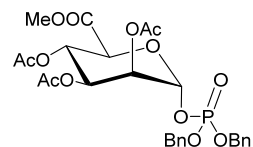

Compound **16** was obtained as described by the general experimental procedure for the synthesis of D-mannopyranosyl uronate dibenzylphosphate (1.29 g, 2.17 mmol, yield: 77%). TLC:  $R_f$  = 0.31 (pentane/ DCM/EtOAc, 2/1/1, v/v/v);  $[\alpha]_D^{20}$  = +33° (c = 0.6, CHCl<sub>3</sub>). <sup>1</sup>H NMR (400 MHz, Chloroform-d)  $\delta$  7.41 – 7.30 (m, 10H), 5.71 (dd, J = 6.6, 2.5 Hz, 1H, H-1), 5.44 – 5.28 (m, 2H, H-4, H-3), 5.24 (t, J = 2.8 Hz, 1H, H-2), 5.09 (dd, J = 8.6, 3.5 Hz, 4H), 4.39 (d, J = 8.9 Hz, 1H, H-5), 3.68 (s, 3H), 2.12 (s, 3H), 2.04 (s, 3H), 2.01 (s, 3H); <sup>13</sup>C NMR (101 MHz, CDCl<sub>3</sub>)  $\delta$  169.46, 169.41, 169.37, 167.08, 135.18, 135.11, 135.07, 135.00, 128.70, 128.60, 128.55, 128.08, 127.94, 94.65 and 94.59 (C-1), 70.60 (C-5), 69.97, 69.92, 69.84, 69.79, 68.16 and 68.05 (C-2), 67.43 (C-3), 66.21 (C-4), 52.75, 20.59, 20.49. HRMS: [M+H]<sup>+</sup> calculated for C<sub>27</sub>H<sub>31</sub>O<sub>13</sub>P: 595.15750; found: 595.15766.

### (Methyl 2,3-di-O-acetyl-4-O-methyl- $\alpha$ -D-mannopyranosyl uronate) dibenzylphosphate (17):

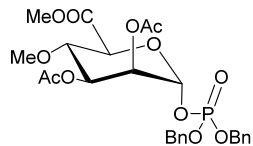

Compound **17** was obtained as described by the general experimental procedure for synthesis of D-mannopyranosyl uronate dibenzylphosphate (0.41 g, 0.724 mmol, yield: 69%). TLC:  $R_f$  = 0.17 (pentane/EtOAc, 2/1, v/v);  $[\alpha]_D^{20}$  = +29° (c = 0.58, CHCl<sub>3</sub>). <sup>1</sup>H NMR (400 MHz, Chloroform-d)  $\delta$  7.37 (p, J = 2.0 Hz, 10H), 5.71 (dd, J = 6.8, 2.4 Hz, 1H, H-1), 5.34 – 5.20 (m, 2H, H-2, H-3), 5.11 (dd, J = 8.3, 6.1 Hz, 4H), 4.37 (d, J = 9.0 Hz, 1H, H-5), 3.87 (t, J = 8.8 Hz, 1H, H-4), 3.75 (s, 3H), 3.46 (s, 3H), 2.74 (s, 1H), 2.14 (s, 3H), 2.08 (s, 3H); <sup>13</sup>C NMR (101 MHz, CDCl<sub>3</sub>)  $\delta$  169.63, 169.61, 168.63, 135.48, 135.41, 135.31, 135.24, 128.77, 128.72, 128.65, 128.16, 128.03, 95.12 and 95.07 (C-1), 75.22 (C-4), 72.43 (C-5), 70.00 (C-3), 69.94, 69.83, 69.78, 68.78 and 68.67 (C-2), 60.35, 52.79, 20.91, 20.81. HRMS: [M+H]<sup>+</sup> calculated for C<sub>26</sub>H<sub>31</sub>O<sub>12</sub>P: 567.16259; found: 567.16270.

### (Methyl 2,3-di-O-acetyl-4-deoxy- $\alpha$ -D-mannopyranosyl uronate) dibenzylphosphate (18):

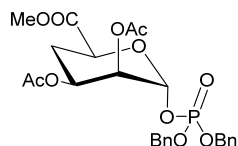

Compound **18** was obtained as described by the general experimental procedure for synthesis of D-mannopyranosyl uronate dibenzylphosphate, (0.714 g, 1.332 mmol, yield: 79%). TLC:

## Chapter 5

$R_f = 0.18$  (pentane/EtOAc, 2/1, v/v);  $[\alpha]_D^{20} = +41^\circ$  ( $c = 1$ ,  $\text{CHCl}_3$ ).  $^1\text{H NMR}$  (400 MHz, Chloroform- $d$ )  $\delta$  7.35 (dd,  $J = 9.0, 4.8$  Hz, 10H), 5.76 (dd,  $J = 6.4, 2.2$  Hz, 1H, H-1), 5.24 (m, 1H, H-3), 5.16 – 5.00 (m, 5H, H-2), 4.51 (dd,  $J = 12.0, 3.0$  Hz, 1H, H-5), 3.71 (s, 3H), 2.21 – 2.13 (m, 1H, H-4), 2.11 (s, 3H), 2.06 (d,  $J = 12.2$  Hz, 1H, H-4), 2.02 (s, 3H);  $^{13}\text{C NMR}$  (101 MHz,  $\text{CDCl}_3$ )  $\delta$  169.69, 169.39, 135.47, 135.40, 135.36, 135.30, 128.75, 128.70, 128.65, 128.20, 128.00, 95.91 and 95.86 (C-1), 69.97, 69.92, 69.81, 69.76, 68.74 (C-5), 66.74 and 66.63 (C-2), 65.31 (C-3), 52.55, 28.20 (C-4), 20.88, 20.83;  $^{31}\text{P NMR}$  (162 MHz,  $\text{CDCl}_3$ )  $\delta$  -2.79. HRMS:  $[\text{M}+\text{H}^+]$  calculated for  $\text{C}_{25}\text{H}_{29}\text{O}_{11}\text{P}$ : 537.15202; found: 537.15217.

**(Methyl 2,3,4-tri-O-acetyl- $\alpha$ -D-mannopyranosyl uronate) phosphate mono-tetrabutylammonium salt (4):** Compound

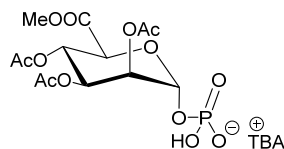

**4** was obtained as by the described general experimental procedure for synthesis of D-mannopyranosyl uronate phosphate, mono-tetrabutylammonium salt (1 mmol, quantitative yield).  $^1\text{H NMR}$  (400 MHz, Chloroform- $d$ )  $\delta$  5.63 (dd,  $J = 7.8, 1.9$  Hz, 1H, H-1), 5.47 (dd,  $J = 10.1, 3.5$  Hz, 1H, H-3), 5.40 – 5.20 (m, 2H, H-2, H-4), 4.72 (d,  $J = 10.2$  Hz, 1H, H-5), 3.67 (s, 3H), 3.34 (m,  $\text{CH}_2$ -TBA), 2.12 (s, 3H), 2.02 (s, 3H), 1.94 (s, 3H), 1.68 (m,  $\text{CH}_2$ -TBA), 1.45 (m,  $\text{CH}_2$ -TBA), 1.00 (t, m,  $\text{CH}_3$ -TBA);  $^{13}\text{C NMR}$  (101 MHz,  $\text{CDCl}_3$ )  $\delta$  169.81, 169.69, 169.37, 168.68, 93.29 and 93.25 (C-1), 69.54 and 69.45 (C-2), 68.92 and 68.71 (C-3, C-5), 67 (C-4), 58.50, 52.03, 23.78, 20.68, 20.52, 20.46, 19.46, 13.51;  $^{31}\text{P NMR}$  (162 MHz,  $\text{CDCl}_3$ )  $\delta$  -1.78. HRMS:  $[\text{M}+\text{H}^+]$  calculated for  $\text{C}_{13}\text{H}_{19}\text{O}_{13}\text{P}$ : 415.06360; found: 415.06328.

**(Methyl 2,3-di-O-acetyl-4-O-methyl- $\alpha$ -D-mannopyranosyl uronate) phosphate, mono-tetrabutylammonium salt (5):**

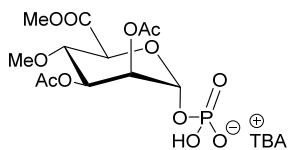

Compound **5** was obtained as described by the general experimental procedure for synthesis of D-mannopyranosyl uronate phosphate, mono-tetrabutylammonium salt (99 mg, 0.158 mmol, yield: 64%).  $^1\text{H NMR}$  (400 MHz, Chloroform- $d$ )  $\delta$  5.63 – 5.51 (m, 1H, H-1), 5.38 – 5.20 (m, 2H, H-2, H-3), 4.51 (d,  $J = 9.9$  Hz, 1H, H-5), 3.77 (s, 3H), 3.72 (d,  $J = 9.5$  Hz, 1H, H-4), 3.38 (s, 3H), 3.33 (m,  $\text{CH}_2$ -TBA), 2.12 (s, 3H), 2.00 (s, 3H), 1.75 – 1.57 (m,  $\text{CH}_2$ -TBA), 1.44 (m,  $\text{CH}_2$ -TBA), 0.99 (t,  $\text{CH}_3$ -TBA);  $^{13}\text{C NMR}$  (101 MHz,  $\text{CDCl}_3$ )  $\delta$  169.90, 169.76, 169.42, 93.72 and 93.70 (C-1), 75.86 (C-4), 71.09 and 70.82 (C-3, C-5), 70.11 and 70.02 (C-2), 59.95, 58.51, 52.06, 23.80, 20.79, 20.76, 19.49, 13.54;  $^{31}\text{P NMR}$  (162 MHz,  $\text{CDCl}_3$ )  $\delta$  -1.56. HRMS:  $[\text{M}+\text{H}^+]$  calculated for  $\text{C}_{12}\text{H}_{19}\text{O}_{12}\text{P}$ : 387.06869; found: 387.06848.

**(Methyl 2,3-di-O-acetyl-4-deoxy- $\alpha$ -D-mannopyranosyl uronate) phosphate, mono-tetrabutylammonium salt (6):**

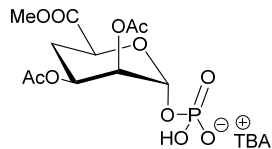

Compound **6** was obtained as described by the general experimental procedure for synthesis of D-mannopyranosyl urinate phosphate, mono-tetrabutylammonium salt (177 mg, yield: 99%).  $^1\text{H NMR}$  (400 MHz, Chloroform- $d$ )  $\delta$  5.64 (dd,  $J = 7.6, 2.0$  Hz, 1H, H-1), 5.40 (m, 1H, H-3), 5.18 (brs, 1H, H-2), 4.83

## Guanosine Diphosphate Mannuronic Acid (GDP-ManA)

(dd,  $J = 12.4, 2.7$  Hz, 1H, H-5), 3.72 (s, 3H), 3.33 (m, CH<sub>2</sub>-TBA), 2.16 – 1.90 (m, 8H, 2xCH<sub>3</sub>CO, H-4), 1.68 (m, CH<sub>2</sub>-TBA), 1.44 (m, CH<sub>2</sub>-TBA), 0.99 (t, CH<sub>3</sub>-TBA); <sup>13</sup>C NMR (101 MHz, CDCl<sub>3</sub>)  $\delta$  170.45, 169.23, 169.00, 93.55 and 93.50 (C-1), 67.47 and 67.38 (C-2), 66.63 (C-5), 66.01 (C-3), 58.05, 51.34, 28.22 (C-4), 23.38, 20.35, 19.08, 13.14; <sup>31</sup>P NMR (162 MHz, CDCl<sub>3</sub>)  $\delta$  -2.02. HRMS: [M+Na<sup>+</sup>] calculated for C<sub>11</sub>H<sub>17</sub>O<sub>11</sub>P: 379.04007; found: 379.04006.

### Guanosine diphosphate mannuronic acid (1):

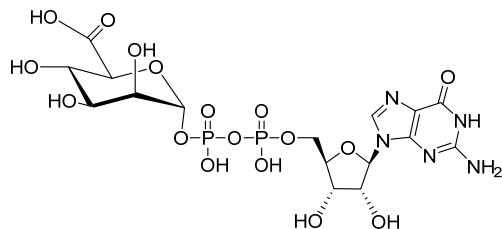

Compound **1** was obtained as described by the general experimental procedure for synthesis of sugar nucleotides (27 mg, 39.8  $\mu$ mol, 40%). <sup>1</sup>H NMR (400 MHz, Deuterium oxide)  $\delta$  8.09 (s, 1H), 5.91 (d,  $J = 6.0$  Hz, 1H, H-1<sub>Rib</sub>), 5.55 (dd,  $J = 8.1, 2.0$  Hz, 1H, H-1<sub>Mann</sub>), 4.74 (t,  $J = 5.6$  Hz, 1H, H-2<sub>Rib</sub>), 4.50 (dd,  $J = 5.2,$

3.4 Hz, 1H, H-3<sub>Rib</sub>), 4.35 (brs, 1H, H-4<sub>Rib</sub>), 4.20 (m, 1H, H-5<sub>Rib</sub>), 4.11 (d,  $J = 9.9$  Hz, 1H, H-5<sub>Mann</sub>), 4.08 – 4.02 (m, 1H, H-2<sub>Mann</sub>), 3.94 (dd,  $J = 9.7, 3.4$  Hz, 1H, H-3<sub>Mann</sub>), 3.79 (t,  $J = 9.8$  Hz, 1H, H-4<sub>Mann</sub>); <sup>13</sup>C NMR (101 MHz, D<sub>2</sub>O)  $\delta$  176.02, 158.57, 153.83, 151.46, 137.27, 115.68, 96.33 and 96.27 (C-1<sub>Mann</sub>), 86.94 (C-1<sub>Rib</sub>), 83.68 and 83.59 (C-4<sub>Rib</sub>), 73.78 (C-2<sub>Rib</sub>), 73.51 (C-5<sub>Mann</sub>), 70.24 (C-3<sub>Rib</sub>), 70.03 and 69.94 (C-2<sub>Mann</sub>), 69.50 (C-3<sub>Mann</sub>), 68.41 (C-4<sub>Mann</sub>), 65.21 and 65.15 (C-5<sub>Rib</sub>); <sup>31</sup>P NMR (162 MHz, D<sub>2</sub>O)  $\delta$  -10.84, -13.15. HRMS: [M+H<sup>+</sup>] calculated for C<sub>16</sub>H<sub>23</sub>N<sub>5</sub>O<sub>17</sub>P<sub>2</sub>: 620.06369; found: 620.06338.

### Guanosine diphosphate 4-O-methyl-mannuronic acid (2):

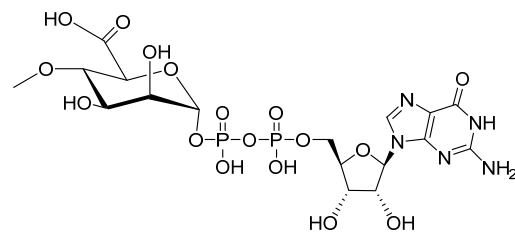

Compound **2** was obtained as described by the general experimental procedure for synthesis of sugar nucleotides (42 mg, 60  $\mu$ mol, 45%). <sup>1</sup>H NMR (400 MHz, Deuterium oxide)  $\delta$  8.10 (s, 1H), 5.90 (d,  $J = 5.8$  Hz, 1H, H-1<sub>Rib</sub>), 5.52 (dd,  $J = 8.1, 2.1$  Hz, 1H, H-1<sub>Mann</sub>), 4.71 (t,  $J = 5.5$  Hz, 1H, H-2<sub>Rib</sub>), 4.49 (dd,  $J = 5.1, 3.6$  Hz, 1H, H-3<sub>Rib</sub>), 4.34 (m, 1H, H-4<sub>Rib</sub>), 4.20 (m,

1H, H-5<sub>Rib</sub>), 4.09 (d,  $J = 10.0$  Hz, 1H, H-5<sub>Mann</sub>), 4.04 (dd,  $J = 3.4, 2.1$  Hz, 1H, H-2<sub>Mann</sub>), 3.95 (dd,  $J = 9.8, 3.4$  Hz, 1H, H-3<sub>Mann</sub>), 3.55 (t,  $J = 9.8$  Hz, 1H, H-4<sub>Mann</sub>), 3.46 (s, 3H); <sup>13</sup>C NMR (101 MHz, D<sub>2</sub>O)  $\delta$  176.21, 158.69, 153.84, 151.54, 137.37, 115.91, 96.36 and 96.30 (C-1<sub>Mann</sub>), 86.97 (C-1<sub>Rib</sub>), 83.77 and 83.68 (C-4<sub>Rib</sub>), 78.96 (C-4<sub>Mann</sub>), 73.90 (C-2<sub>Rib</sub>), 73.64 (C-5<sub>Mann</sub>), 70.33 (C-3<sub>Rib</sub>), 70.26 (C-2<sub>Mann</sub>), 69.23 (C-3<sub>Mann</sub>), 65.29 and 65.23 (C-5<sub>Rib</sub>), 59.91; <sup>31</sup>P NMR (162 MHz, D<sub>2</sub>O)  $\delta$  -10.80, -13.31. HRMS: [M+H<sup>+</sup>] calculated for C<sub>17</sub>H<sub>25</sub>N<sub>5</sub>O<sub>17</sub>P<sub>2</sub>: 634.07934; found: 634.08193.

### Guanosine diphosphate 4-deoxy-mannuronic acid (3):

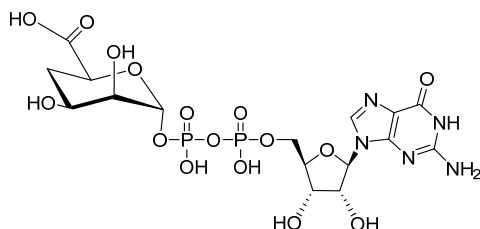

Compound **3** was obtained as described by the general experimental procedure for synthesis of sugar nucleotides (53 mg, 80  $\mu$ mol, 80%). <sup>1</sup>H NMR (400

## Chapter 5

---

MHz, Deuterium Oxide)  $\delta$  8.11 (s, 1H), 5.95 (d,  $J$  = 5.7 Hz, 1H, H-1<sub>Rib</sub>), 5.65 (dd,  $J$  = 7.9, 2.0 Hz, 1H, H-1<sub>Mann</sub>), 4.75 (t,  $J$  = 5.5 Hz, 1H, H-2<sub>Rib</sub>), 4.53 (dd,  $J$  = 5.2, 3.8 Hz, 1H, H-3<sub>Rib</sub>), 4.44 (dd,  $J$  = 12.6, 2.7 Hz, 1H, H-5<sub>Mann</sub>), 4.39-4.37 (m, 1H, H-4<sub>Rib</sub>), 4.22 (m, 2H, H-5<sub>Rib</sub>, H-3<sub>Mann</sub>), 3.93 (t,  $J$  = 2.6 Hz, 1H, H-2<sub>Mann</sub>), 2.21 – 2.05 (m, 1H), 1.81 (q,  $J$  = 12.4 Hz, 1H); <sup>13</sup>C NMR (101 MHz, D<sub>2</sub>O)  $\delta$  178.24, 158.86, 153.85, 151.59, 137.41, 116.17, 96.98 and 96.93 (C-1<sub>Mann</sub>), 86.98 (C-1<sub>Rib</sub>), 83.67 and 83.58 (C-4<sub>Rib</sub>), 73.92 (C-2<sub>Rib</sub>), 70.31 (C-3<sub>Rib</sub>), 70.26 (C-5<sub>Mann</sub>), 68.10 and 68.02 (C-2<sub>Mann</sub>), 65.30 and 65.24 (C-5<sub>Rib</sub>), 64.59 (C-3<sub>Mann</sub>), 30.61; <sup>31</sup>P NMR (162 MHz, D<sub>2</sub>O)  $\delta$  -11.21, -13.52. HRMS: [M+H<sup>+</sup>] calculated for C<sub>16</sub>H<sub>23</sub>N<sub>5</sub>O<sub>16</sub>P<sub>2</sub><sup>-</sup>: 604.06878; found: 604.06864.

## 5.5 References

- [1] B. H. A. Rehm, *Alginates: Biology and Applications*, Springer, 2009.
- [2] L.R. Evans, A. Linker, *J. Bacteriol*, **1973**, *116*, 915-924.
- [3] B. H. A. Rehm, S. Valla, *Appl. Microbiol. Biotechnol*, **1997**, *48*, 281-288.
- [4] A. M. Stephen, G. O. Phillips, P. A. Williams, *Food Polysaccharides and Their Applications*, second Ed., New York **1995**.
- [5] K. Y. Lee, D. J. Mooney, *Prog. Polym. Sci*, **2012**, *37*, 106-126.
- [6] J. Sun, H. Tan, *Materials*, **2013**, *6*, 1285-1309.
- [7] G. B. Pier, F. Coleman, M. Grout, M. Franklin, D. E. Ohman, *Inf. Immun*, **2001**, *69*, 1895-1901.
- [8] G. Sjøk-Bræk, H. Grasdalen, B. Larsen, *Carbohydr. Res*, **1986**, *154*, 239-250.
- [9] M. J. Franklin, D. E. Nivens, J. T. Weadge, P. L. Howell, *Front. Microbiol*, **2011**, *2*, 167.
- [10] H. Ertesvåg, *Front Microbiol*, **2015**, *6*, 523.
- [11] Z. U. Rehman, Y. Wang, M. Fata Moradali, I. D. Hay, B. H. A. Rehm, *Appl. Environ. Microbiol*, **2013**, *79*, 3264-3272.
- [12] L. L. Oglesby, S. Jain, D. E. Ohman *Microbiol*, **2008**, *154*, 1605-1615.
- [13] U. Remminghorst and B. H. A. Rehm, *Appl. Environ. Microbiol*, **2006**, *72*, 298-305.
- [14] L. M. Riley, J. T. Weadge, P. Baker, H. Robinson, J. D. C. Codée, P. A. Tipton, D. E. Ohman, and P. L. Howell, *J. Biol. Chem*, **2013**, *288*, 22299-22314.
- [15] P. Baker, T. Ricer, P. J. Moynihan, E. N. Kitova, M. T. C. Walvoort, D. J. Little, J. C. Whitney, K. Dawson, J. T. Weadge, H. Robinson, D. E. Ohman, J. D. C. Codée, J. S. Klassen, A. J. Clarke, P. L. Howell, *PLoS Pathog*, **2014**, *10*, e1004334.
- [16] M. J. Franklin, S. A. Douthit, M. A. McClure, *J. Bacteriol*, **2004**, *186*, 4759-4773.
- [17] M. J. Franklin, C. E. Chitnis, P. Gacesa, A. Sonesson, D. C. White, D. E. Ohman, *J. Bacteriol*, **1994**, *176*, 1821-1830.
- [18] S. Jain, M. J. Franklin, H. Ertesvåg, S. Valla, and D. E. Ohman, *Mol. Microbiol*, **2003**, *47*, 1123-1133.
- [19] F. Wolfram, E. N. Kitova, H. Robinson, M. T. C. Walvoort, J. D. C. Codée, J. S. Klassen, P. L. Howell, *J.*



*Biol. Chem*, **2014**, *289*, 6006-6019.

- [20] A. Jerga, A. Raychaudhuri, P. A. Tipton, *Biochem*, **2006**, *45*, 552-560.
- [21] A. Jerga, M. D. Stanley, P. A. Tipton, *Biochem*, **2006**, *45*, 9138-9144.
- [22] E. K. Farrell, P. A. Tipton, *Biochem*, **2012**, *51*, 10259-10266.
- [23] K. Bakkevig, H. Sletta, M. Gimmestad, R. Aune, H. Erstesvåg, K. Degnes, B.E. Christensen, T.E. Ellingsen, S. Valla, *J. Bact*, **2005**, *187*, 8375-8384.
- [24] S. Jain, D. E. Ohman, *Infect. Immun*, **2005**, *73*, 6429-6436.
- [25] M. T. Albrecht, N. L. Schiller, *J. Bact*, **2005**, *187*, 3869-3872.
- [26] J. S. Gunn, L. O. Bakaletz, D. J. Wozniak, *J. Biol. Chem*, **2016**, *291*, 12538-12546.
- [27] P. Baker, P. J. Hill, B. D. Snarr, N. Alnabelseya, M. J. Pestrak, M. J. Lee, L. K. Jennings, J. Tam, R. A. Melnyk, M. R. Parsek, D. C. Sheppard, D. J. Wozniak, P. L. Howell, *Science Adv*, **2016**, *2*, e1501632.
- [28] N. Gjorevski, N. Sachs, A. Manfrin, S. Giger, M. Bragina, P. Ordóñez-Morán, H. Clevers, M. P. Lutolf, *Nature*, **2016**, *539*, 560-564.
- [29] G. D. D'ayala, M. Malinconico, P. Laurienzo, *Molecules*, **2008**, *13*, 2069-2106.
- [30] R. Danac, L. Ball, S. J. Gurr, A. J. Fairbanks, *Carbohydr. Res*, **2008**, *343*, 1012-1022.
- [31] Z. Xu, *Bioorg. Med. Chem. Lett*, **2015**, *25*, 3777-3783.
- [32] G. K. Wagner, T. Pesnot, R. A. Field, *Nat. Prod. Rep*, **2009**, *26*, 1172-1194.
- [33] J. G. Moffatt, H. G. Khorana, *J. Am. Chem. Soc*, **1958**, *80*, 3756-3761.
- [34] A. L. Marlow, L. L. Kiessling, *Org. Lett*, **2001**, *3*, 2517-2519.
- [35] R. Chang, P. Moquist, N. S. Finney, *Carbohydr. Res*, **2004**, *339*, 1531-1536.
- [36] H. Tanaka, Y. Yoshimura, M. R. Jørgensen, J. A. C. Seijo, O. Hindsgaul, *Angew. Chem., Int. Ed*, **2012**, *51*, 11531-11534.
- [37] S. Wendicke, S. Warnecke, C. Meier, *Angew. Chem., Int. Ed*, **2008**, *47*, 1500-1502.
- [38] S. Wolf, R. M. Berrio, C. Meier, *Eur. J. Org. Chem*, **2011**, 6304-6313.
- [39] L. Li, Y. Lui, Y. Wan, Y. Li, W. Zhao, P. G. Wang, *Org. Lett*, **2013**, *15*, 5528-5530.
- [40] H. Gold, P. van Delft, N. Meeuwenoord, J. D. C. Codeé, D. V. Filippov, G. Eggink, H. S. Overkleeft, and G. A. van der Marel, *J. Org. Chem*, **2008**, *73*, 9458-9460.
- [41] H. Gold, K. Descroix, J. D. C. Codeé, G. A. van der Marel, *Carbohydrate Chemistry: Proven Synthetic Methods 1*, **2011**, 107.
- [42] H. A. V. Kistemaker, L. N. Lameijer, N. J. Meeuwenoord, H. S. Overkleeft, G. A. van der Marel, and D. V. Filippov, *Angew. Chem., Int. Ed*, **2015**, *54*, 4915-4918.
- [43] H. A. V. Kistemaker, N. J. Meeuwenoord, H. S. Overkleeft, G. A. van der Marel, and D. V. Filippov, *Eur. J. Org. Chem*, **2015**, *27*, 6084-6091.
- [44] H. A. V. Kistemaker, A. P. Nardoza, H. S. Overkleeft, A. G. Ladurner, G. A. van der Marel, and D. V.

- Filippov, *Angew. Chem., Int. Ed.*, **2016**, *55*, 10634-10638.
- [45] G. J. van der Heden van Noort, H. S. Overkleef, G. A. van der Marel, and D. V. Filippov, *J. Org. Chem.*, **2010**, *75*, 5733-5736.
- [46] Compound **8** was obtained from Toly 2,3-di-O-acetyl-4,6-O-benzylidene-1-thio- $\alpha$ -D-mannopyranoside: P.S. Patil, C.-C. Lee, Y.-W. Huang, M.M.L. Zulueta, S.-C. Hung, *Org. Biomol. Chem.*, **2013**, *11*, 2605-2612.
- [47] J. B. Epp and T. S. Widlanski, *J. Org. Chem.*, **1999**, *64*, 293-295.
- [48] A. De Mico, R. Margarita, L. Parianti, A. Vescovi, G. Piancatelli, *J. Org. Chem.*, **1997**, *62*, 6974-6977.
- [49] L. J. van den Bos, J. D. C. Codée, J. C. van der Toorn, T. J. Boltje, J. H. van Boom, H. S. Overkleef, G. A. van der Marel, *Org. Lett.*, **2004**, *6*, 2165-2168.
- [50] M. T. C. Walvoort, D. Sail, J. D. C. Codée, G. A. van der Marel, *Carbohydrate Chemistry: Proven Synthetic Methods 1*, **2011**, 99.
- [51] Q. Zhang, E. R. van Rijssel, M. T. C. Walvoort, H. S. Overkleef, G. A. van der Marel and J. D. C. Codée, *Angew. Chem., Int. Ed.*, **2015**, *54*, 7670-7673.
- [52] C. H. Depuy, R. W. King, *Chem. Rev.*, **1960**, *60*, 431-457.
- [53] H. R. Nace, *Org. React.*, **1962**, *12*, 57.
- [54] B. A. Garcia and D. Y. Gin, *Org. Lett.*, **2000**, *2*, 2135-2138.
- [55] M. T. C. Walvoort, G. Lodder, J. Mazurek, H. S. Overkleef, J. D. C. Codée, G. A. van der Marel, *J. Am. Chem. Soc.*, **2009**, *131*, 12080-12081.
- [56] M. T. C. Walvoort, G. Lodder, H. S. Overkleef, J. D. C. Codée, G. A. van der Marel, *J. Org. Chem.*, **2010**, *75*, 7990-8002.
- [57] J. Ronnols, M. T. C. Walvoort, G. A. van der Marel, J. D. C. Codee, G. Widmalm, *Org. Biomol. Chem.*, **2013**, *11*, 8127-8134.
- [58] E. R. van Rijssel, A. P. A. Janssen, A. Males, G. J. Davies, G. A. Van der Marel, H. S. Overkleef, J. D. C. Codée, *ChemBioChem*, **2017**, *18*, 1297-1304.

# 6

## **Selective oxidation of primary alcohols to carboxylic acids by use of a two-steps one-pot TEMPO/BAIB-Pinnick oxidation sequence**

Partly published in: *Org. Lett.* **2017**, *19*, 2514-2517.

### **6.1 Introduction**

Uronic acids are defined as aldoses of which the primary alcohol is oxidized to a carboxylic acid function.<sup>[1]</sup> They are widespread in nature, where they constitute key components of oligo- and polysaccharides and glycoconjugates, found in all life forms.<sup>[1]</sup> The structural complexity of oligo- and polysaccharides and glycoconjugates that contain uronic acid, combined with their diverse biological properties, has inspired many chemist to study their synthesis.<sup>[2]</sup> To obtain these bioactive compounds, two key challenges have to be addressed. The first is the formation of the interglycosidic linkages, which is generally more difficult with uronic acids with respect to their non-oxidized counterparts because of the

diminished reactivity of the former, both from a donor and acceptor point of view. Secondly, the primary alcohol has to be oxidized, selectively with respect to all other hydroxyl functionalities, to produce the corresponding uronic acid. This may entail the use of a protecting group strategy, in which the primary alcohol can be selectively unmasked, or, alternatively, a chemoselective oxidation protocol may be called upon to oxidize the more accessible primary alcohol in the presence of free secondary ones. In execution of the former strategy, a number of methods have been employed for the oxidation of primary alcohols to provide the corresponding uronic acids, including the use of a Swern or Dess-Martin oxidation to generate the intermediate glycosyl aldehyde, followed by a second oxidation using  $\text{NaClO}_2$  to deliver the acid, the use of chromium based oxidants, such as the Jones oxidation ( $\text{CrO}_3$ ,  $\text{H}_2\text{SO}_4$ ) and pyridinium dichromate (Collins reagent, PDC).<sup>[3]</sup>

The advent of TEMPO (2,2,6,6-tetramethyl-1-piperidinyloxy free radical) mediated oxidation methods, presented a major breakthrough for the generation of glycuronic acids as these systems allowed for the regioselective oxidation of the primary alcohol in the presence of (many) other free secondary alcohols.<sup>[4]</sup> The original protocol for TEMPO oxidations employs  $\text{NaOCl}$  as a cooxidant, in a biphasic mixture using a phase transfer catalyst.<sup>[5]</sup> Although this method has found wide application in the generation of glycuronic acids, the biphasic mixture and the fact that two oxidation steps have to be performed (alcohol to the aldehyde and aldehyde to the acid) can make optimization of this procedure difficult, especially when multiple alcohols have to be transformed into the corresponding acids.<sup>[6]</sup> Several co-oxidants have been introduced to effect TEMPO mediated oxidations, such as electro-oxidation,<sup>[7]</sup> *m*-chloroperbenzoic acid,<sup>[8]</sup> high-valent

metal salts,<sup>[9]</sup> sodium bromite,<sup>[10]</sup> sodium or calcium hypochlorite,<sup>[11]</sup> and trichloroisocyanuric acid<sup>[12]</sup>. Piancatelli then introduced the hypervalent iodine reagent, bisacetoxo iodobenzene (BAIB) as an effective co-oxidant for the selective transformation of primary alcohols into aldehydes.<sup>[13]</sup> Subsequently, Epp and Widlanski used the TEMPO/BAIB reagent combination to prepare nucleoside-5'-carboxylic acids.<sup>[14]</sup> Van den Bos *et al.* were the first to explore the use of this reagent couple for the generation of glycosyl uronic acid building blocks for the use in oligosaccharide synthesis and they reported that partially protected thioglycosides could be oxidized in a chemo- and regioselective manner to effectively generate the corresponding glycuronic acid thioglycosides.<sup>[15]</sup> Since then, the TEMPO/BAIB oxidation system has become one of the popular methods for the oxidation of carbohydrate building blocks and oligosaccharides.

Notwithstanding the success of the TEMPO/BAIB reagent combination, recent complex substrates have proven to be a challenge to effectively oxidize. These include the simultaneous oxidation of multiple primary alcohols to their corresponding acids, such as in Huang's hyaluronic acid oligosaccharide synthesis, in which three alcohols had to be transformed.<sup>[16]</sup> Chapter 7 of this Thesis presents the assembly of a set of zwitterionic oligosaccharides of *Streptococcus pneumonia*, which also proved challenging substrates for the TEMPO/BAIB oxidation method. Recently, Hagen *et al.* described the synthesis of the trisaccharide repeating unit of the *Staphylococcus aureus* Strain M Capsular Polysaccharide, in which a surprising side reaction plagued the generation of disaccharide **12b** (see Scheme 6.1).<sup>[17]</sup> During the oxidation of disaccharide **12a**, using the TEMPO/BAIB system, monosaccharide **11c** was formed as the main byproduct, with only small amounts of expected disaccharide **12b**.<sup>[17a]</sup> The exact mechanism of the formation of **11c** is unclear,

but it was observed that the intermediate aldehyde was formed uneventfully.<sup>[17a]</sup> Consumption of this aldehyde proved to be very slow, and it is likely that the glycosidic bond cleavage event occurs at this stage.<sup>[17a]</sup> To enable the oxidation of these challenging substrates, a more effective oxidation procedure is required. This Chapter describes the development of a novel TEMPO/BAIB based oxidation system, which is combined in a one-pot two-step protocol with a Pinnick oxidation to effectively transform carbohydrate primary alcohols into the corresponding carboxylic acids.

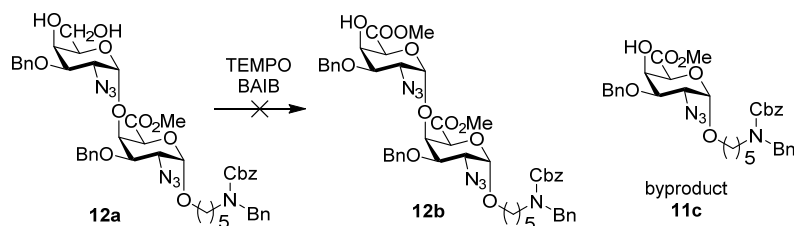

**Scheme 6.1** The oxidation reaction of the *S. aureus* disaccharide **12a** to yield **12b**.

## 6.2 Results and discussion

The transformation of a primary alcohol into a carboxylic acid entails a two-step transformation: oxidation of the alcohol into the aldehyde and subsequent further oxidation of the aldehyde into the carboxylic acid. For most oxidation procedures an extra intermediate step is required: the formation of the hydrate of the aldehyde, which can engage in the nucleophilic attack of the actual oxidizing species. The low rate of the second oxidation step in the unmodified TEMPO/BAIB reaction may be in part be attributable to the heterogeneity of the reaction mixture ( $\text{CH}_2\text{Cl}_2/\text{H}_2\text{O}$ ) and the slow hydration of the intermediate aldehyde.<sup>[17a]</sup> Of the many methods that exist for the

oxidation of aldehydes to carboxylic acids, the Pinnick oxidation stands out as it is one of the few methods that does not proceed by intermediate hydration of the aldehyde.<sup>[18]</sup> It was therefore envisaged that an effective oxidation sequence could be developed that combines the advantages of the TEMPO/BAIB system was -the excellent chemo- and regioselectivity in an operationally simple set up- with the power of the Pinnick oxidation: rapid oxidation of aldehydes to the corresponding acids without the need for the formation of the hydrate.

To establish the feasibility of such a TEMPO/BAIB-Pinnick oxidation sequence, glucose diol **1a** was used as a model substrate. First, different conditions were tested for the formation of the aldehyde. Using THF as solvent, the reaction was very slow, requiring two days for completion, owing to the insolubility of BAIB in THF. The use of a mixture of THF and DCM provided a faster reaction (7h) and a mixture of THF/*t*BuOH/DCE led to an even faster reaction (5h). After the subsequent Pinnick oxidation, in the same pot, glucuronic acid **1b** was obtained in 67%, 90% and 87% yield over the two steps, respectively (Table 6.1, Entry 1-3). Using the optimal solvent system, several model carbohydrate diols were oxidized as summarized in Table 6.1. D-Glucose, D-galactose, L-gulose, D-mannose, L-gulofuranose, D-galactose and D-galacto-azide building blocks **2-11**, bearing different protecting and functional groups were probed and in each case the regioselectivity of the first oxidation step proved to be excellent and the ensuing Pinnick oxidation effective to deliver the desired carboxylic acids in 60%-87% yield (Entry 4-13). It must be noted, however, that in the case of thioglycosides, a small amount (around 8%) of sulfoxide was found as a byproduct. As TEMPO/BAIB has been shown to be compatible with thiol aglycons, the sulfoxide side products likely arise from the NaClO<sub>2</sub>-mediated Pinnick

oxidation. The oxidation of L-gulofuranose 1,2-diol **7a** led to carbon-carbon bond cleavage and the isolation of the truncated D-ribose carboxylic acid **7b** (Entry 9). When the TEMPO/BAIB-Pinnick protocol was used for the oxidation of disaccharide **12a**, the carboxylic acid was formed successfully, yielding the desired disaccharide **12b**, which can be used for synthesis of the *Staphylococcus aureus* Strain M Capsular Polysaccharide trisaccharide repeating unit, after methylation of the crude carboxylic acid, in a rewarding 84% yield (Entry 14). Finally, the new protocol was applied for the more complex hexasaccharide tetraol **13a**<sup>[23]</sup>, featuring two primary alcohol functionalities (Entry 15). The oxidation of these two alcohols required a longer time for the TEMPO/BAIB step and 0.4 equivalents of TEMPO per alcohol. The desired dicarboxylate **13b**<sup>[19]</sup> was obtained in 60% yield.



## Two-steps one-pot TEMPO/BAIB-Pinnick oxidation

**Table 6.1** Substrate Scope of the TEMPO/BAIB-Pinnick Oxidation Sequence

$\text{1a-13a} \xrightarrow{\text{TEMPO, BAIB}} \left[ \text{Intermediate} \right] \xrightarrow{\text{Pinnick oxidation}} \text{1b-13b}$

**1a** R = CH<sub>2</sub>OH  
**1b** R = COOH

**2a** R = CH<sub>2</sub>OH, R' = Bn  
**2b** R = COOH, R' = Bn  
**3a** R = CH<sub>2</sub>OH, R' = Bz  
**3b** R = COOH, R' = Bz

**4a** R = CH<sub>2</sub>OH  
**4b** R = COOH

**5a** R = CH<sub>2</sub>OH  
**5b** R = COOH

**6a** R = CH<sub>2</sub>OH  
**6b** R = COOH

**8a** R = CH<sub>2</sub>OH, R' = Bn  
**8b** R = COOH, R' = Bn  
**9a** R = CH<sub>2</sub>OH, R' = Bz  
**9b** R = COOH, R' = Bz

**11a** R = CH<sub>2</sub>OH  
**11b** R = COOH  
**11c** R = COOMe

**12a** R = CH<sub>2</sub>OH  
**12b** R = COOMe

**13a** R = CH<sub>2</sub>OH  
**13b** R = COOH

**7a** R = CHOH-CH<sub>2</sub>OH  
**7b** R = COOH

**10a** R = CH<sub>2</sub>OH  
**10b** R = COOH

Entry	SM	Time	product	Yield	Entry	SM	Time	product	Yield
1	<b>1a</b>	2d	<b>1b</b>	67% <sup>[a]</sup>	9	<b>7a</b>	7h	<b>7b</b>	87% <sup>[d]</sup>
2	<b>1a</b>	7h	<b>1b</b>	90% <sup>[b]</sup>	10	<b>8a</b>	7h	<b>8b</b>	73%
3	<b>1a</b>	5h	<b>1b</b>	87% <sup>[c]</sup>	11	<b>9a</b>	7h	<b>9b</b>	73%
4	<b>2a</b>	10h	<b>2b</b>	81%	12	<b>10a</b>	4h	<b>10b</b>	84% <sup>[c]</sup>
5	<b>3a</b>	7h	<b>3b</b>	74%	13	<b>11a</b>	6h	<b>11b</b>	80%
6	<b>4a</b>	7h	<b>4b</b>	82%	14	<b>12a</b>	5h	<b>12b</b>	84%
7	<b>5a</b>	5h	<b>5b</b>	87%	15	<b>13a</b>	2d	<b>13b</b>	60% <sup>[c]</sup>
8	<b>6a</b>	7h	<b>6b</b>	85%					

[a] THF as solvent, [b] THF/DCM as solvent, [c] 0.4 eq TEMPO per primary alcohol, THF/*t*BuOH/DCE as solvent; [d] from carbon-carbon bond cleaved byproduct.

### 6.3 Conclusion

A novel two-step one-pot TEMPO/BAIB-Pinnick oxidation protocol was invented to allow for the effective regioselective oxidation of primary alcohols to give the corresponding acids. The protocol was successfully applied for synthesis of the *Staphylococcus aureus* Strain M Capsular Polysaccharide trisaccharide repeating unit and for complex hexasaccharide tetraol **13a**, which represents a model system for the synthesis of larger zwitterionic polysaccharide **SP1** repeating units as described in Chapter 7 of this Thesis.

### 6.4 Experimental section

All reagents were of commercial grade and used as received. All moisture sensitive reactions were performed under an argon atmosphere. Reactions were monitored by TLC analysis with detection by UV (254 nm) and where applicable by spraying with 20% sulfuric acid in EtOH or with a solution of  $(\text{NH}_4)_6\text{Mo}_7\text{O}_{24}\cdot 4\text{H}_2\text{O}$  (25 g/L) and  $(\text{NH}_4)_4\text{Ce}(\text{SO}_4)_4\cdot 2\text{H}_2\text{O}$  (10 g/L) in 10% sulfuric acid (aq.) followed by charring at  $-150\text{ }^\circ\text{C}$ . Flash column chromatography was performed on silica gel (40-63 $\mu\text{m}$ ).  $^1\text{H}$  and  $^{13}\text{C}$  spectra were recorded on a Bruker AV 400, Bruker AV 600 in  $\text{CDCl}_3$  or  $\text{CD}_3\text{OD}$ . Chemical shifts ( $\delta$ ) are given in ppm relative to tetramethylsilane as internal standard ( $^1\text{H}$  NMR in  $\text{CDCl}_3$ ) or the residual signal of the deuterated solvent. Coupling constants ( $J$ ) are given in Hz. All  $^{13}\text{C}$  spectra are proton decoupled. NMR peak assignments were made using COSY and HSQC experiments. Where applicable NOESY, HMBC, HMBC and GATED experiments were used to further elucidate the structure.

#### General procedure for the TEMPO/ $\text{PhI}(\text{OAc})_2$ -Pinnick oxidation sequence.

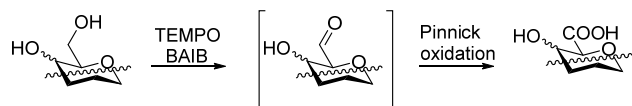

To a stirred solution of the carbohydrate (0.2 mmol, 1.0 eq.) in THF/ $\text{CH}_2\text{Cl}_2$  (2:1 v/v, 2 mL, 0.1 M) was added, at  $0\text{ }^\circ\text{C}$ , TEMPO (6.3 mg, 0.04 mmol, 0.2 eq.) and  $\text{PhI}(\text{OAc})_2$  (64 mg, 0.2 mmol, 1.0 eq.) and the reaction mixture was allowed to warm to room temperature. After 1 hour, a second portion of  $\text{PhI}(\text{OAc})_2$  (26 mg, 0.08 mmol, 0.4 eq.) was added and the reaction mixture was stirred until TLC analysis (usually  $\text{CH}_2\text{Cl}_2/\text{MeOH}$ , 20:1 v/v) indicated complete conversion of the starting material (see Table 2). Then, *tert*-butanol (0.5 mL) and *iso*-amylene (0.05 mL) were added and the reaction mixture was cooled to  $0\text{ }^\circ\text{C}$ . A solution of  $\text{NaClO}_2$  (36 mg, 0.4 mmol, 2.0 eq.) and

## Two-steps one-pot TEMPO/BAIB-Pinnick oxidation

NaH<sub>2</sub>PO<sub>4</sub> (48 mg, 0.4 mmol, 2.0 eq.) in water (0.2 mL) was slowly added and the reaction mixture was allowed to stir for 1 hour at 0 °C. The reaction was quenched by addition of sat. aq. Na<sub>2</sub>S<sub>2</sub>O<sub>3</sub>, and the mixture diluted with EtOAc, and NaH<sub>2</sub>PO<sub>4</sub> (sat. aq., 0.5 mL) and brine (1 mL) were subsequently added. The layers were separated, and the aqueous phase was extracted with EtOAc. The combined organic phases were dried over MgSO<sub>4</sub>, filtered and concentrated *in vacuo*. Column chromatography (generally, CH<sub>2</sub>Cl<sub>2</sub>/MeOH/AcOH, 200:1:0 → 200:10:1) furnished the corresponding uronic acid.

**Propargyl 2,3-di-O-benzyl- $\alpha$ -D-mannopyranoside (5a):** Propargyl 4,6-O-benzylidene- $\alpha$ -D-mannopyranoside<sup>[20]</sup> (306

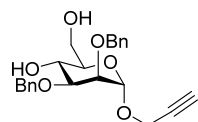

mg, 1 mmol) was dissolved in DMF (4 ml) and then NaH (60% in oil, 120 mg, 3 mmol) was added at 0°C. After 15 min, BnBr (475  $\mu$ l, 4 mmol) was added to the reaction mixture and stirred for overnight. The reaction was quenched by adding water. Then diluted with EtOAc, washed with brine, dried over Na<sub>2</sub>SO<sub>4</sub> and concentrated *in vacuo*. The crude

product was dissolved in MeOH (10 ml) and TsOH·H<sub>2</sub>O (PH = 2) was added to the reaction mixture and stirred for overnight. The reaction was quenched with Et<sub>3</sub>N and concentrated *in vacuo*. Purification by column chromatography. Yield: 261 mg (0.66 mmol), 66% over two steps. <sup>1</sup>H NMR (400 MHz, CDCl<sub>3</sub>)  $\delta$  7.41 – 7.22 (m, 10H, CH<sub>arom</sub>), 5.03 (d, *J* = 1.7 Hz, 1H, H-1), 4.64 (s, 2H, PhH<sub>2</sub>), 4.52 (q, *J* = 11.8 Hz, 2H, PhH<sub>2</sub>), 4.16 (t, *J* = 2.1 Hz, 2H, -OCH<sub>2</sub>C $\equiv$ CH), 4.04 (t, *J* = 9.7 Hz, 1H, H-4), 3.87 – 3.73 (m, 3H, H-2, H-6), 3.69 (dd, *J* = 9.6, 3.1 Hz, 1H, H-3), 3.58 (m, 1H, H-5), 3.27 (bs, 1H, -OH), 2.89 (bs, 1H, -OH), 2.42 (t, *J* = 2.4 Hz, 1H, -OCH<sub>2</sub>C $\equiv$ CH). <sup>13</sup>C NMR (100 MHz, CDCl<sub>3</sub>)  $\delta$  138.13, 137.90 (C<sub>q</sub>), 128.45, 127.97, 127.69(CH<sub>arom</sub>), 96.69 (C-1), 79.41 (C-3), 78.82 (-OCH<sub>2</sub>C $\equiv$ CH), 75.03 (-OCH<sub>2</sub>C $\equiv$ CH), 73.94 (C-2), 73.00 (C-5), 72.87 (Bn), 71.84 (Bn), 66.88 (C-4), 62.35 (C-6), 54.26 (-OCH<sub>2</sub>C $\equiv$ CH). [ $\alpha$ ]<sub>D</sub><sup>20</sup> = 23° (c = 1.0, CHCl<sub>3</sub>). IR (neat): 698, 739, 1028, 1043, 1074, 1118, 1366, 1454, 2919, 3279, 3450. HR-MS: [M+H]<sup>+</sup> Calculated for C<sub>23</sub>H<sub>26</sub>O<sub>6</sub>: 399.18022; found: 399.18018.

### Scheme 6.1 Synthesis of compounds 10a

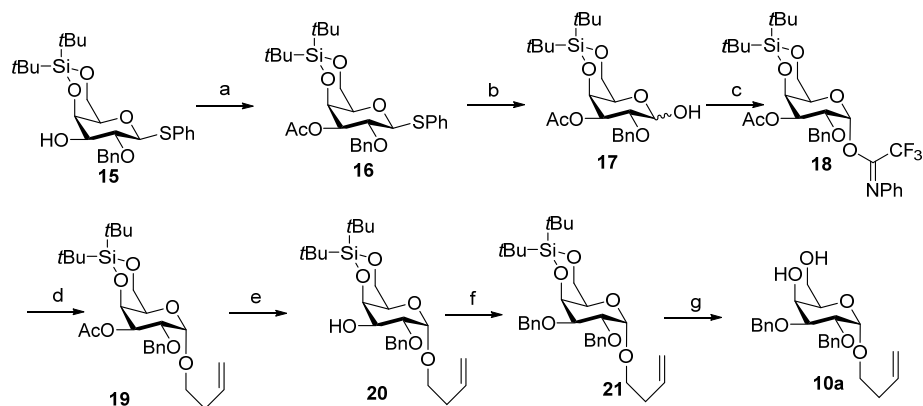

Reagents and conditions: (a) Ac<sub>2</sub>O, pyridine, 99%; (b) NIS, TFA, DCM, 91%; (c) *N*-phenyl trifluoroacetimidoyl

## Chapter 6

chloride,  $K_2CO_3$ , acetone, 92%; (d) 3-buten-1-ol, TBSOTf, DCM, 94%,  $\alpha:\beta = 25:1$ ; (e) NaOMe, MeOH, 94%; (f) NaH, BnBr, DMF, 70%, (g) HF/pyridine, THF, pyridine, 96%.

**2-O-benzyl-3-O-acetyl-4,6-di-*tert*-butylsilylidene-1-thio- $\beta$ -D-galactopyranoside (16):** The compound **15**<sup>[19]</sup> (1.01 g, 2

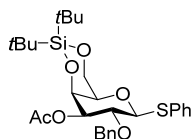

mmol) was dissolved in pyridine (4 ml),  $Ac_2O$  was added in the reaction mixture at 0 °C, and then DMAP (24 mg, 0.2 mmol) was added to the reaction mixture. The reaction was allowed to stir at room temperature for overnight. The reaction was concentrated *in vacuo*. Purification by column chromatography (PE:EA, 20:1 to 10:1). Yield: 1.048 g, 66%.

$^1H$  NMR (400 MHz, Chloroform-*d*)  $\delta$  7.54 (dd,  $J = 7.8, 1.8$  Hz, 2H), 7.45 – 7.12 (m, 8H), 4.95 (d,  $J = 10.8$  Hz, 1H), 4.86 – 4.54 (m, 4H, H-3, H-1, H-4), 4.32 – 4.10 (m, 2H, H-6), 3.90 (t,  $J = 9.6$  Hz, 1H, H-2), 3.41 (d,  $J = 2.1$  Hz, 1H, H-5), 2.07 (s, 3H), 1.12 (s, 9H), 1.01 (s, 9H).  $^{13}C$  NMR (101 MHz,  $CDCl_3$ )  $\delta$  170.67, 138.11, 132.22, 128.93, 128.45, 128.15, 127.90, 127.58, 88.64 (C-1), 77.36 (C-3), 75.78, 75.77 (C-2), 74.49 (C-5), 70.29 (C-4), 67.21 (C-6), 27.66, 27.62, 23.33, 21.06, 20.78. IR (neat): 651, 692, 745, 827, 971, 1044, 1090, 1166, 1238, 1363, 1473, 1739, 2859, 2933. HR-MS:  $[M+H]^+$  Calculated for  $C_{29}H_{40}SSiO_6$ : 545.2388; found: 545.2387.

**2-O-benzyl-3-O-acetyl-4,6-di-*tert*-butylsilylidene- $\alpha/\beta$ -D-galactopyranoside (17):** The compound **16** (1.16 g, 2.129

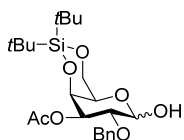

mmol) was dissolved in DCM (20 ml), NIS (527 mg, 2.342 mmol) was added in the reaction mixture at 0 °C, and then TFA (174  $\mu$ l, 2.342 mmol) was added to the reaction mixture. After analysis by TLC showed complete consumption of the starting material, the reaction was quenched with  $Et_3N$ . Saturated  $Na_2S_2O_3$  (aq) was added to the reaction mixture, which

was then stirred for 30 min. The aqueous layer was extracted twice with  $CH_2Cl_2$  and concentrated *in vacuo*. Purification by column chromatography (silica gel, pentane/DCM/EtOAc, 3/1/1, v/v/v) yielded **17** as a colourless oil (880 mg, 91%,  $\alpha:\beta = 3.5:1$ ). TLC:  $R_f = 0.15$  (pentane/DCM/EtOAc, 3/1/1, v/v/v).  $^1H$  NMR (400 MHz, Chloroform-*d*)  $\delta$  7.41 – 7.26 (m, 5H), 5.23 (d,  $J = 3.6$  Hz, 0.75H, H-1 $\alpha$ ), 5.06 (dd,  $J = 10.2, 3.0$  Hz, 0.75H, H-3 $\alpha$ ), 4.90 (d,  $J = 11.4$  Hz, 0.22H, H-3 $\beta$ ), 4.81 – 4.54 (m, 3H, H-4 $\alpha$ , H-4 $\beta$ ), 4.28 – 4.19 (m, 1H, H-6), 4.13 (dd,  $J = 12.6, 1.7$  Hz, 0.75H, H-6), 4.06 – 3.90 (m, 2H, H-2 $\alpha$ , H-5 $\alpha$ ), 3.75 (dd,  $J = 9.9, 7.6$  Hz, 0.22H, H-2 $\beta$ ), 3.49 (q,  $J = 1.6$  Hz, 0.23H, H-5 $\beta$ ), 2.96 (bs, 1H), 2.11 (s, 2.22H), 2.09 (s, 0.56H), 1.07 (s, 1.88H), 1.00 (m, 15H).  $^{13}C$  NMR (101 MHz,  $CDCl_3$ )  $\delta$  170.87, 128.67, 128.51, 128.24, 128.07, 127.89, 97.72 (C-1 $\beta$ ), 92.06 (C-1 $\alpha$ ), 77.22 (C-2 $\beta$ ), 75.63 (C-3 $\beta$ ), 75.03, 73.68 (C-2 $\alpha$ ), 73.19 (C-3 $\alpha$ ), 72.74, 71.37 (C-5 $\beta$ ), 71.02 (C-4 $\alpha$ ), 70.26 (C-4 $\beta$ ), 67.18 (C-6 $\alpha$ ), 67.14 (C-5 $\alpha$ ), 67.09 (C-6 $\beta$ ), 27.67, 27.64, 27.50, 27.37, 23.40, 21.21, 20.78. HR-MS:  $[M+Na]^+$  Calculated for  $C_{23}H_{36}SiO_7$ : 475.2123; found: 475.2126.

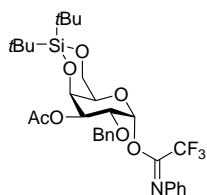

**2-O-benzyl-3-O-acetyl-4,6-di-*tert*-butylsilylidene-1-O-(*N*-phenyl trifluoroacetimidoyl)- $\alpha/\beta$ -D-galactopyranoside (18):** The compound **17** (0.87 g, 1.922 mmol) was dissolved in acetone (10 ml),  $K_2CO_3$  (318 mg, 2.31 mmol) was added to reaction mixture at 0 °C. After 15 min, *N*-phenyl trifluoroacetimidoyl chloride (599 mg, 2.883 mmol) was added

## Two-steps one-pot TEMPO/BAIB-Pinnick oxidation

to the reaction mixture at 0 °C, and then it was allowed to stir for overnight at room temperature. Then, Et<sub>3</sub>N was added to the reaction mixture, which was filtered and the resulting filtrate was concentrated *in vacuo*. Purification by column chromatography (silica gel, pentane/EtOAc, 50/1 to 10/1, v/v) yielded **18** as a colourless syrup (1.102 g, 92%,  $\alpha:\beta = 2:1$ ). **18** $\alpha$  (at 50 °C) <sup>1</sup>H NMR (500 MHz, Chloroform-*d*)  $\delta$  7.38 – 7.16 (m, 5H), 7.07 (td,  $J = 7.5, 1.1$  Hz, 1H), 6.74 (d,  $J = 7.8$  Hz, 2H), 6.47 (bs, 1H, H-1), 5.09 (dd,  $J = 10.3, 2.9$  Hz, 1H, H-3), 4.79 (d,  $J = 2.9$  Hz, 1H, H-4), 4.71 (s, 2H), 4.30 – 4.08 (m, 3H, H-6, H-2), 3.90 (s, 1H, H-5), 2.09 (d,  $J = 0.9$  Hz, 3H), 1.01 (d,  $J = 0.9$  Hz, 9H), 0.97 (s, 9H). <sup>13</sup>C NMR (126 MHz, CDCl<sub>3</sub>)  $\delta$  170.60, 143.88, 137.90, 128.87, 128.62, 128.10, 128.02, 124.37, 119.63, 94.66 (C-1), 73.64, 72.77 (C-3), 72.09 (C-2), 70.65 (C-4), 69.74 (C-5), 66.85 (C-6), 27.71, 27.35, 23.40, 21.02, 20.86. HR-MS: [M+Na<sup>+</sup>] Calculated for C<sub>31</sub>H<sub>40</sub>N<sub>3</sub>O<sub>7</sub>F<sub>3</sub>Si: 646.2418; found: 646.2421.

**3-butenyl 2-O-benzyl-3-O-acetyl-4,6-di-*tert*-butylsilylidene- $\alpha$ -D-mannopyranoside (19):** Imidate donor **18** $\alpha$  (680 mg,

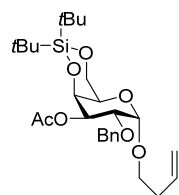

1.09 mmol) and acceptor allyl carbinol (293  $\mu$ l, 3.386 mmol) were co-evaporated with toluene (three times). The residue was dissolved in dry DCM (11 ml). The solution was cooled to 0 °C and TBSOTf (51  $\mu$ l, 0.22 mmol) was added, after which the reaction was allowed to stir for 1 h. TLC show the reaction was finish. Then the reaction was quenched with Et<sub>3</sub>N and diluted with EtOAc, washed with sat. aq. NaCl and the organic phase was

dried over Na<sub>2</sub>SO<sub>4</sub> and concentrated *in vacuo*. Purification by column chromatography (silica gel, pentane/EtOAc, 20/1, v/v) yielded **20** as a colourless syrup (520 mg, 94%,  $\alpha:\beta = 25:1$ ). TLC: R<sub>f</sub> = 0.63 (pentane/ EtOAc, 8/1, v/v). <sup>1</sup>H NMR (500 MHz, Chloroform-*d*)  $\delta$  7.41 – 7.28 (m, 5H), 5.81 (m, 1H), 5.15 – 4.92 (m, 3H, H-3), 4.79 – 4.67 (m, 4H, H-1, H-4), 4.61 (d,  $J = 12.2$  Hz, 1H), 4.21 (dd,  $J = 12.6, 2.2$  Hz, 1H, H-6), 4.09 (dd,  $J = 12.6, 1.7$  Hz, 1H, H-6), 4.02 (dd,  $J = 10.4, 3.6$  Hz, 1H, H-2), 3.74 (bs, 1H, H-5), 3.65 (m, 1H), 3.49 (m, 1H), 2.44 – 2.27 (m, 2H), 2.10 (s, 3H), 1.00 (s, 9H), 0.98 (s, 9H). <sup>13</sup>C NMR (126 MHz, CDCl<sub>3</sub>)  $\delta$  170.83, 138.32, 135.03, 128.52, 128.28, 127.99, 116.83, 97.85 (C-1), 73.31, 72.88 (C-3), 72.62 (C-2), 71.02 (C-4), 67.72, 67.09 (C-6), 66.88 (C-5), 33.98, 27.68, 27.33, 23.39, 21.19, 20.74. IR (neat): 650, 698, 737, 764, 798, 826, 863, 909, 977, 994, 1002, 1005, 1030, 1039, 1079, 1104, 1150, 1173, 1237, 1363, 1473, 1739, 2858, 2933. HR-MS: [M+H<sup>+</sup>] Calculated for C<sub>27</sub>H<sub>42</sub>SiO<sub>7</sub>: 529.2592; found: 529.2590.

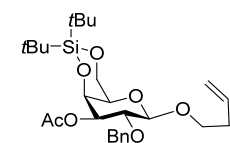

<sup>1</sup>H NMR (500 MHz, Chloroform-*d*)  $\delta$  7.33 (d,  $J = 3.8$  Hz, 5H), 5.85 (m, 1H), 5.19 – 4.99 (m, 2H), 4.89 (d,  $J = 11.5$  Hz, 1H), 4.70 – 4.68 (m, 1H, H-3), 4.68 – 4.63 (m, 2H), 4.59 (dd,  $J = 3.2, 0.9$  Hz, 1H, H-4), 4.43 (d,  $J = 7.7$  Hz, 1H, H-1), 4.21 (m, 2H, H-6), 3.98 (m, 1H), 3.75 (dd,  $J = 10.0, 7.7$  Hz, 1H, H-2), 3.59 (m, 1H), 3.40 (bs, 1H, H-5), 2.45 – 2.31 (m, 2H), 2.07 (s, 3H), 1.05 (s, 9H), 1.00 (s, 9H). <sup>13</sup>C NMR (126 MHz, CDCl<sub>3</sub>)  $\delta$  170.92, 138.75, 135.33, 128.35, 128.01, 127.66, 116.52, 103.61 (C-1), 75.98 (C-2), 75.49 (C-3), 74.90, 70.83 (C-5), 70.31 (C-4), 68.91, 67.16 (C-6), 34.43, 27.61, 27.53, 23.38, 21.08, 20.83.

## Chapter 6

**3-butenyl 2-O-benzyl-4,6-di-tert-butylsilylidene- $\alpha$ -D-mannopyranoside (20):** The compound **19** (665 mg, 1.312

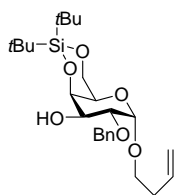

mmol) was dissolved in MeOH (15 ml). The solution was cooled to 0 °C and NaOMe in MeOH solution (4 drops) was added, after which the reaction was allowed to stir for overnight at room temperature. TLC show the reaction was finish. Then the reaction was quenched with Amberlite IR120 (H<sup>+</sup>) resin. After filtration, the filtrate was concentrated *in vacuo*. Purification by column chromatography (silica gel, pentane/EtOAc, 8/1, v/v) yielded

**20** as a colourless syrup (571 mg, 94). TLC:  $R_f$  = 0.20 (pentane/ EtOAc, 8/1, v/v). <sup>1</sup>H NMR (500 MHz, Chloroform-*d*)  $\delta$  7.40 – 7.22 (m, 5H), 5.89 – 5.69 (m, 1H), 5.15 – 4.94 (m, 2H), 4.82 (d,  $J$  = 12.0 Hz, 1H), 4.76 (d,  $J$  = 3.5 Hz, 1H, H-1), 4.69 (d,  $J$  = 12.0 Hz, 1H), 4.43 (d,  $J$  = 3.5 Hz, 1H, H-4), 4.25 (d,  $J$  = 12.5 Hz, 1H, H-6), 4.15 (d,  $J$  = 12.5 Hz, 1H, H-6), 3.96 (m, 1H, H-3), 3.72 (s, 1H, H-5), 3.70 – 3.56 (m, 2H, H5, H-2), 3.50 – 3.38 (m, 1H), 2.35 (q,  $J$  = 7.1 Hz, 2H), 1.10 – 0.98 (m, 9H), 0.99 – 0.85 (m, 9H). <sup>13</sup>C NMR (126 MHz, CDCl<sub>3</sub>)  $\delta$  138.36, 135.07, 128.55, 128.37, 127.97, 116.83, 97.65 (C-1), 75.87 (C-2), 73.73 (C-4), 73.04, 69.84 (C-3), 67.63, 67.07 (C-5), 67.03 (C-6), 33.99, 27.68, 27.32, 23.47, 20.75. IR (neat): 649, 762, 797, 827, 862, 917, 974, 997, 1030, 1037, 1085, 1121, 1167, 1232, 1345, 1363, 1473, 2859, 2933. HR-MS: [M+Na<sup>+</sup>] Calculated for C<sub>25</sub>H<sub>40</sub>SiO<sub>6</sub>: 487.2486; found: 487.2490.

**3-butenyl 2,3-di-O-benzyl-4,6-di-tert-butylsilylidene- $\alpha$ -D-mannopyranoside (21):** The compound **20** (186 mg, 0.4

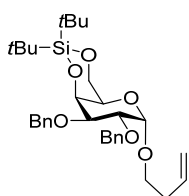

mmol) was dissolved in DMF (2 ml). The solution was cooled to 0 °C and NaH (60% in mineral oil, 32 mg, 0.8 mmol) was added, after which the reaction was allowed to stir for overnight at room temperature. Then the reaction was quenched with H<sub>2</sub>O and diluted with EtOAc, washed with sat. aq. NaCl and the organic phase was dried over Na<sub>2</sub>SO<sub>4</sub> and concentrated *in vacuo*. Purification by column chromatography (silica gel, pentane/EtOAc, 50/1, v/v) yielded **21** as a colourless syrup (156 mg, 70%). (And also found byproduct ) TLC:

$R_f$  = 0.63 (pentane/EtOAc, 10/1, v/v). <sup>1</sup>H NMR (400 MHz, Chloroform-*d*)  $\delta$  7.50 – 7.19 (m, 10H), 5.79 (m, 1H), 5.11 – 4.97 (m, 2H), 4.87 (d,  $J$  = 12.0 Hz, 1H), 4.73 (d,  $J$  = 2.2 Hz, 3H, H-1), 4.67 (d,  $J$  = 12.0 Hz, 1H), 4.50 (dd,  $J$  = 3.1, 1.0 Hz, 1H, H4), 4.26 (d, 12.5, 1H, H-6), 4.14 (d, 12.5, 1H, H-6), 3.98 (dd,  $J$  = 10.0, 3.7 Hz, 1H, H-2), 3.82 (dd,  $J$  = 10.1, 3.0 Hz, 1H, H-3), 3.63 (m, H-5), 3.52 (m, 1H), 2.45 – 2.25 (m, 2H), 1.06 (s, 9H), 0.99 (s, 9H). <sup>13</sup>C NMR (101 MHz, CDCl<sub>3</sub>)  $\delta$  139.12, 138.75, 135.08, 128.38, 128.36, 128.30, 127.70, 127.67, 127.50, 116.68, 98.10 (C-1), 77.73 (C-3), 74.35 (C-2), 73.65, 71.31 (C-4), 71.15, 67.53 (C-6), 67.34 (C-5), 67.29, 33.96, 27.75, 27.41, 23.51, 20.74. IR (neat): 697, 735, 764, 798, 827, 861, 915, 977, 1068, 1097, 1148, 1363, 2858, 2933. HR-MS: [M+Na<sup>+</sup>] Calculated for C<sub>32</sub>H<sub>46</sub>SiO<sub>6</sub>: 577.2956; found: 577.2957.

## Two-steps one-pot TEMPO/BAIB-Pinnick oxidation

**The byproduct:**  $^1\text{H}$  NMR (400 MHz, Chloroform-*d*)  $\delta$  7.50 – 7.11 (m, 20H), 5.78 (m, 1H), 5.12 – 4.97 (m, 2H), 4.97 –

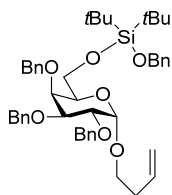

4.88 (m, 3H), 4.87 (s, 1H), 4.83 (s, 1H, H-1), 4.81 (d,  $J$  = 8.5 Hz, 1H), 4.73 (d,  $J$  = 11.8 Hz, 1H), 4.67 (d,  $J$  = 12.1 Hz, 1H), 4.59 (d,  $J$  = 11.4 Hz, 1H), 4.03 (dd,  $J$  = 10.0, 3.6 Hz, 1H, H-2), 3.98 – 3.91 (m, 2H, H-3, H-6), 3.88 (d,  $J$  = 2.8 Hz, 1H, H-4), 3.82 – 3.72 (m, 2H, H-5, H-6), 3.65 (m, 1H), 3.47 (m, 1H), 2.36 (m, 2H), 1.04 (s, 18H).  $^{13}\text{C}$  NMR (101 MHz,  $\text{CDCl}_3$ )  $\delta$  141.20, 139.05, 138.83, 138.81, 135.03, 128.46, 128.40, 128.32, 128.24, 128.05, 127.71, 127.62, 127.60, 126.98, 125.81, 116.73, 97.34 (C-1), 79.18 (C-3), 76.76 (C-2), 75.41 (C-4), 74.86, 73.40, 73.36,

71.45 (C-5), 67.11, 65.57, 63.33 (C-6), 33.95, 28.05, 21.39, 21.34.

**3-butenyl 2,3-di-O-benzyl- $\alpha$ -D-mannopyranoside (5a):** HF/Pyridine solution (100  $\mu\text{l}$ ) was added to a solution of

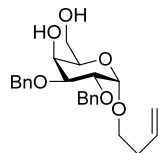

compound **21** (104 mg, 0.187 mmol) in a mixture of THF (1 ml) and pyridine (1 ml) at 0  $^\circ\text{C}$ . The reaction was allowed to stir 2h at room temperature. Then, a sat. aq.  $\text{NaHCO}_3$  was added to neutralize the mixture, which was diluted with EtOAc, washed with sat. aq. NaCl. The organic phase was dried over  $\text{Na}_2\text{SO}_4$  and concentrated *in vacuo*. Purification by column

chromatography (silica gel, DCM/MeOH, 50/1, v/v) yielded **5a** as a colourless oil (75 mg, 96%). TLC:  $R_f$  = 0.26 (DCM/MeOH, 20/1, v/v);  $^1\text{H}$  NMR (400 MHz, Chloroform-*d*)  $\delta$  7.41 – 7.28 (m, 10H), 5.82 (m, 1H), 5.15 – 5.01 (m, 2H, H-1), 4.88 – 4.76 (m, 3H), 4.67 (dd,  $J$  = 16.6, 11.8 Hz, 2H), 4.08 (dd,  $J$  = 3.2, 1.3 Hz, 1H, H-4), 3.96 – 3.73 (m, 5H, H-3, H-2, H-5), 3.68 (m, 1H), 3.51 (m, 1H), 2.48 – 2.30 (m, 2H).  $^{13}\text{C}$  NMR (101 MHz,  $\text{CDCl}_3$ )  $\delta$  138.52, 138.19, 134.99, 128.65, 128.53, 128.08, 128.06, 127.98, 127.95, 127.93, 116.92, 97.42 (C-1), 77.48 (C-3), 75.83 (C-2), 73.40, 73.07, 69.36 (C-4), 69.07 (C-5), 67.59, 63.26 (C-6), 33.95. IR (neat): 696, 733, 736, 914, 967, 999, 1036, 1070, 1094, 1145, 1207, 1347, 1458, 2912, 3445. HR-MS:  $[\text{M}+\text{Na}^+]$  Calculated for  $\text{C}_{33}\text{H}_{38}\text{N}_4\text{O}_8$ : 437.1935; found: 437.1943.

**Methyl 2,3-di-O-benzyl- $\alpha$ -D-glucopyranosiduronic acid (1b):**

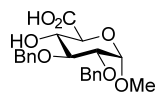

The title compound was obtained from **1a** in 87% yield (68 mg, 0.17 mmol).  $^1\text{H}$  NMR (400 MHz)  $\delta$ : 7.44-7.27 (m, 10H,  $\text{CH}_{\text{arom}}$ ); 4.91 (d, 1H,  $J$  = 11.3 Hz, PhCHH); 4.86-4.74 (m, 2H,  $\text{PhCH}_2$ ); 4.71-4.57 (m, 2H, H-1, PhCHH); 4.16 (d, 1H,  $J$  = 9.5 Hz, H-5); 3.84 (d, 1H,  $J$  = 9.0 Hz, H-3); 3.77 (d, 1H,  $J$  = 9.1 Hz, H-4); 3.52 (dd, 1H,  $J$  = 3.4 Hz, 9.3 Hz, 1H, H-2); 3.42 (s, 3H,  $\text{OCH}_3$ ).  $^{13}\text{C}$ -APT NMR (100 MHz,  $\text{CDCl}_3$ )  $\delta$  172.9 (C-6); 138.5, 137.9 ( $\text{C}_{\text{q,arom}}$ ); 128.7, 128.3, 128.3, 128.2, 128.04 ( $\text{CH}_{\text{arom}}$ ); 98.8 (C-1); 80.4 (C-3); 78.4 (C-2); 75.7, 73.8 ( $\text{PhCH}_2$ ); 71.7 (C-4); 69.7 (C-5); 56.2 ( $\text{OCH}_3$ ). IR (neat) v: 2932, 1724, 1452, 1274, 1097, 1053, 1028, 989. HR-MS:  $[\text{M}+\text{H}]^+$  calculated for  $\text{C}_{21}\text{H}_{24}\text{O}_7$ : 389.15948; found 389.15940.

**Phenyl 2,3-di-O-benzyl-1-thio- $\beta$ -D-glucopyranosiduronic acid (2b):**

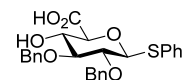

The title compound was obtained from **2a** in 81% yield (76 mg, 0.16 mmol).  $^1\text{H}$  NMR (400 MHz)  $\delta$ : 7.59 (dd, 2H,  $J$  = 2.3, 7.3 Hz,  $\text{CH}_{\text{arom}}$ ); 7.47-7.30 (m, 13H,  $\text{CH}_{\text{arom}}$ ); 4.96 (d, 1H,  $J$  = 11.1 Hz, PhCHH); 4.92-4.84 (m, 2H,  $\text{PhCH}_2$ ); 4.79 (d, 1H,  $J$  = 10.3 Hz, PhCHH); 4.75 (d, 1H,  $J$  = 9.8 Hz, H-1); 3.94-3.83 (m, 2H, H-4, H-5); 3.66 (t, 1H,  $J$  = 8.2 Hz, H-3); 3.51 (t, 1H,  $J$  = 9.2 Hz, H-2).  $^{13}\text{C}$ -APT NMR

## Chapter 6

(100 MHz)  $\delta$  172.2 (C-6); 138.7, 137.8, 132.9 ( $C_{q,arom}$ ); 132.5, 129.2, 128.5, 128.5, 128.5, 128.3, 128.1, 128.0, 128.0, 127.9, 127.9 ( $CH_{arom}$ ); 88.1 (C-1); 85.3 (C-3); 79.6 (C-2); 76.8 (C-5); 75.7, 75.6 ( $PhCH_2$ ); 71.95 (C-4). IR (neat)  $\nu$ : 2928, 1732, 1356, 1132, 1067, 1026. HR-MS:  $[M+H]^+$  calculated for  $C_{26}H_{26}O_6S$ : 467.15229; found 467.15220.

**2,3-di-O-benzoyl- $\alpha$ -1-thio-phthyl-D-glucopyranose uronic acid (3b):** This product was prepared following general

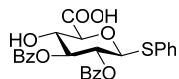

procedure for selective oxidation of primary alcohol to carboxylic acid by use of two steps one-pot TEMPO/BAIB-Pinnick oxidation. TLC:  $R_f$  = 0.19 (DCM:MeOH:AcOH = 20:2:0.1).

Yield: 73 mg (0.15 mmol), 74%.  $^1H$  NMR (500 MHz,  $CDCl_3$ )  $\delta$  8.02 – 7.91 (m, 2H,  $CH_{arom}$ ), 7.86 (d,  $J$  = 7.9 Hz, 2H,  $CH_{arom}$ ), 7.58 – 7.12 (m, 11H,  $CH_{arom}$ ), 5.70 (t,  $J$  = 9.4 Hz, 1H, H-3), 5.39 (t,  $J$  = 9.7 Hz, 1H, H-2), 5.05 (d,  $J$  = 10.0 Hz, 1H, H-1), 4.17 (d,  $J$  = 9.8 Hz, 1H, H-5), 4.08 (d,  $J$  = 9.5 Hz, 1H, H-4).  $^{13}C$  NMR (125 MHz,  $CDCl_3$ )  $\delta$  171.4 (-COOH), 166.64, 165.35 (Bz), 133.52, 133.46, 133.01 ( $CH_{arom}$ ), 131.96 ( $C_q$ ), 130.04, 129.98, 129.25, 129.21, 129.03, 128.53, 128.48 ( $CH_{arom}$ ), 86.67 (C-1), 77.51 (C-5), 76.03 (C-3), 70.41 (C-4), 70.05 (C-2).  $[\alpha]^{20}_D$  = 79° ( $c$  = 1.0,  $CHCl_3$ ). IR (neat): 691, 708, 750, 1026, 1069, 1086, 1134, 1274, 1728. HR-MS:  $[M+Na]^+$  Calculated for  $C_{26}H_{22}O_8S$ : 517.09276; found: 517.09244.

**3-azidopropyl 2,3-di-O-benzyl- $\alpha$ -L-gulopyranosiduronic acid (4b):** The title compound was obtained from **4a** in 82%

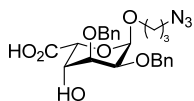

yield (17 mg, 0.037 mmol).  $^1H$  NMR (500 MHz)  $\delta$ : 7.38-7.26 (m, 10H,  $CH_{arom}$ ); 4.94 (s, 1H, H-1); 4.82 (d, 1H,  $J$  = 11.8 Hz,  $PhCHH$ ); 4.75 (s, 1H, H-5); 4.64-4.57 (m, 3H,  $PhCH_2$ ); 4.27 (s, 1H, H-4); 3.83 (bs, 3H, H-2, H-3,  $OCHH_{propyl}$ ); 3.46 (s, 1H,  $OCHH_{pentyl}$ ); 3.33 (d, 2H,  $J$  =

5.7 Hz,  $N_3CH_2_{propyl}$ ); 1.84 (m, 2H,  $CH_2_{propyl}$ ).  $^{13}C$  NMR (126 MHz)  $\delta$ : 172.9 (C-6); 138.4, 137.9 ( $C_{q,arom}$ ); 129.1, 128.5, 128.3, 127.9, 127.7, 127.0 ( $CH_{arom}$ ); 98.0 (C-1); 75.4 (C-3); 73.0 (C-2,  $PhCH_2$ ); 71.8 ( $PhCH_2$ ); 69.6 (C-4); 68.2 (C-5); 65.4 ( $OCH_2_{propyl}$ ); 48.1 ( $N_3CH_2_{propyl}$ ); 28.9 ( $CH_2_{propyl}$ ). IR (neat)  $\nu$ : 2924, 2096, 1732, 1454, 1258, 1209, 1116, 1086, 1070, 1037, 1028. HR-MS:  $[M+H]^+$  calculated for  $C_{23}H_{27}N_3O_7$ : 458.19218; found 458.19219.

**Propargyl 2,3-di-O-benzyl- $\alpha$ -D-mannopyranosiduronic acid (5b):** The title compound was obtained from **5a** in 87%

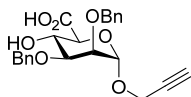

yield (74 mg, 0.17 mmol).  $^1H$  NMR (500 MHz)  $\delta$ : 7.37-7.25 (m, 10H,  $CH_{arom}$ ); 5.12 (d, 1H,  $J$  = 1.7 Hz, H-1); 4.75-4.55 (m, 4H,  $PhCH_2$ ); 4.33-4.16 (m, 3H, H-4,  $OCH_2_{propargyl}$ ); 4.13 (d, 1H,  $J$  = 9.8 Hz, H-5); 3.81-3.72 (m, 2H, H-2, H3).  $^{13}C$ -APT NMR (125 MHz)  $\delta$ : 172.4 (C-6); 138.2,

137.9 ( $C_{q,arom}$ ); 128.4, 128.0, 128.0, 127.8, 127.7, 127.7 ( $CH_{arom}$ ); 97.6 (C-1); 78.6 ( $C_{q,propargyl}$ ); 78.4 (C-3); 75.4 ( $CH_{propargyl}$ ); 74.3 (C-2); 73.3, 72.8 ( $PhCH_2$ ); 71.3 (C-5); 68.5 (C-4); 55.4 ( $CH_2_{propargyl}$ ). IR (neat)  $\nu$ : 3280, 2922, 1728, 1454, 1358, 1250, 1207, 1121, 1072, 1043. HR-MS:  $[M+H]^+$  calculated for  $C_{23}H_{24}O_7$ : 413.15948; found 413.15946.

**Methyl 3,4-dimethoxybutan- $\alpha$ -D-mannopyranose uronic acid (6b):** This product was prepared following general

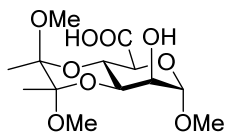

procedure for selective oxidation of primary alcohol to carboxylic acid by use of two steps one-pot TEMPO/BAIB-Pinnick oxidation. TLC:  $R_f$  = 0.14 (DCM:MeOH:AcOH = 15:1:0.1). Yield: 82 mg (0.25 mmol), 85%.  $^1H$  NMR (400 MHz,  $CD_3CN$ )  $\delta$  4.68 (d,  $J$  = 1.2



## Two-steps one-pot TEMPO/BAIB-Pinnick oxidation

Hz, 1H, H-1), 4.18 – 4.04 (m, 1H, H-4), 3.99 (d,  $J = 10.0$  Hz, 1H, H-5), 3.87 – 3.75 (m, 2H, H-2, H-3), 3.36 (s, 3H, -OMe), 3.21 (s, 3H, -OMe), 3.19 (s, 3H, -OMe), 1.26 (s, 3H, -CH<sub>3</sub>), 1.20 (s, 3H, -CH<sub>3</sub>). <sup>13</sup>C NMR (101 MHz, CD<sub>3</sub>CN)  $\delta$  170.22 (-COOH), 103.23 (C-1), 100.97, 100.63, 70.85 (C-5), 69.43 (C-2), 68.28 (C-3), 65.35 (C-4), 55.68 (-OMe), 48.15 (-OMe), 18.03 (-CH<sub>3</sub>). [ $\alpha$ ]<sub>D</sub><sup>20</sup> = 192° (c = 1.0, CHCl<sub>3</sub>). IR (neat): 754, 885, 982, 1047, 1076, 1113, 1215, 1379, 1741, 2947, 3460. HR-MS: [M+Na<sup>+</sup>] Calculated for C<sub>13</sub>H<sub>22</sub>O<sub>9</sub>: 345.11560; found: 345.11553.

**2,3-isopropyl- $\alpha$ -D-lyxose uronic acid (7b):** This sideproduct was obtained following general procedure for selective

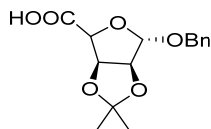

oxidation of primary alcohol to carboxylic acid by use of two steps one-pot TEMPO/BAIB-Pinnick oxidation. Yield: 77 mg, 87%. <sup>1</sup>H NMR (500 MHz, CDCl<sub>3</sub>)  $\delta$  7.40 – 7.27 (m, 5H, CH<sub>arom</sub>), 5.29 (s, 1H), 5.07 (dd,  $J = 5.8, 4.3$  Hz, 1H, H-2), 4.78 – 4.64 (m, 3H, H-3, H-4, PhHH), 4.52 (d,  $J = 11.7$  Hz, 1H, PhHH), 1.46 (s, 3H, -CH<sub>3</sub>), 1.31 (s, 3H, -CH<sub>3</sub>).

<sup>13</sup>C NMR (125 MHz, CDCl<sub>3</sub>)  $\delta$  171.52 (-COOH), 136.81 (C<sub>q</sub>), 128.64, 128.20 (CH<sub>arom</sub>), 113.64, 105.83 (C-1), 84.28 (C-4), 80.53 (C-2), 79.58 (C-3), 69.56 (Bn), 26.00 (-CH<sub>3</sub>), 24.98 (-CH<sub>3</sub>). [ $\alpha$ ]<sub>D</sub><sup>20</sup> = 46° (c = 1.0, CHCl<sub>3</sub>). IR (neat): 700, 737, 860, 966, 1043, 1080, 1113, 1211, 1375, 1454, 1744, 2940, 2982. HR-MS: [M+Na<sup>+</sup>] Calculated for C<sub>15</sub>H<sub>18</sub>O<sub>6</sub>: 295.11761; found: 295.11759.

**Phenyl 2,3-di-O-benzyl-1-thio- $\beta$ -D-galactopyranosiduronic acid (8b):** The title compound was obtained from **8a** in

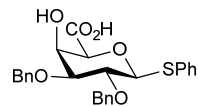

73% yield (68 mg, 0.15 mmol). <sup>1</sup>H NMR (400 MHz)  $\delta$ : 7.67-7.52 (m, 2H, CH<sub>arom</sub>); 7.43-7.15 (m, 13H, CH<sub>arom</sub>); 4.81 (d, 1H,  $J = 10.3$  Hz, PhCHH); 4.78-4.68 (m, 2H, PhCH<sub>2</sub>); 4.65-4.61 (m, 2H, H-1, PhCHH); 4.45 (d, 1H,  $J = 3.1$  Hz, H-4); 4.03 (s, 1H, H-5); 3.77 (t, 1H,  $J = 9.4$  Hz,

H-2); 3.61 (dd, 1H,  $J = 3.2, 9.0$  Hz, H-3). <sup>13</sup>C-APT NMR (100 MHz)  $\delta$ : 171.0 (C-6); 138.1, 137.5, 133.4 (C<sub>q,arom</sub>); 132.5, 129.1, 128.6, 128.5, 128.5, 128.4, 128.2, 128.1, 128.0, 127.9 (CH<sub>arom</sub>); 88.1 (C-1); 81.7 (C-3); 77.1 (C-5); 76.5 (C-2); 75.9, 72.0 (PhCH<sub>2</sub>); 67.7 (C-4). IR (neat) v: 2924, 1730, 1454, 1362, 1269, 1211, 1124, 1096, 1026. HR-MS: [M+H]<sup>+</sup> calculated for C<sub>26</sub>H<sub>26</sub>O<sub>6</sub>S: 467.15229; found 467.15218.

**Phenyl 2,3-di-O-benzoyl-1-thio- $\beta$ -D-galactopyranosiduronic acid (9b):** The title compound was obtained from **9a** in

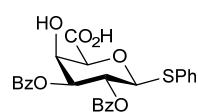

73% yield (72 mg, 0.15 mmol). <sup>1</sup>H NMR (400 MHz)  $\delta$ : 7.91 (dd, 4H, 7.8 Hz, 15.9 Hz, CH<sub>arom</sub>); 7.57-7.09 (m, 11H, CH<sub>arom</sub>); 5.81 (t, 1H,  $J = 9.8$  Hz, H-2); 5.40 (dd, 1H,  $J = 3.0, 9.8$  Hz, H-3); 4.97 (d, 1H,  $J = 10.0$  Hz, H-1); 4.74 (s, 1H, H-4); 4.53 (bs, 1H, OH); 4.38 (s, 1H, H-

5). <sup>13</sup>C-APT NMR (100 MHz)  $\delta$ : 170.7 (C-6); 165.9, 165.5 (CO<sub>Bz</sub>); 133.5, 133.4, 133.0 (CH<sub>arom</sub>); 132.4 (C<sub>q,arom</sub>); 130.0, 130.0 (CH<sub>arom</sub>); 129.4 (C<sub>q,arom</sub>); 129.2 (CH<sub>arom</sub>); 129.0 (C<sub>q,arom</sub>); 128.5, 128.4 (CH<sub>arom</sub>); 87.0 (C-1); 77.7 (C-5); 74.8 (C-3); 68.5 (C-4); 67.9 (C-2). IR (neat) v: 1724, 1601, 1450, 1315, 1277, 1128, 1088, 1070, 1026. HR-MS: [M+H]<sup>+</sup> calculated for C<sub>26</sub>H<sub>22</sub>O<sub>8</sub>S: 495.11081; found 495.11089.

## Chapter 6

**(10b)**: The title compound was obtained from **10a** in 84% yield (36 mg, 0.084 mmol).  $^1\text{H}$  NMR (400 MHz, Chloroform-*d*)  $\delta$  7.42 – 7.17 (m, 10H), 5.78 (m, 1H), 5.16 – 4.99 (m, 2H), 4.89 (d,  $J = 3.5$  Hz, 1H, H-1), 4.85 – 4.68 (m, 3H), 4.62 (d,  $J = 12.1$  Hz, 1H), 4.41 (bs, 2H, H-4, H-5), 3.99 – 3.82 (m, 2H, H-3, H-2), 3.67 (m, 1H), 3.53 (m, 1H), 2.44 – 2.24 (m, 2H).  $^{13}\text{C}$  NMR (101 MHz,  $\text{CDCl}_3$ )  $\delta$  172.08, 138.31, 137.88, 134.73, 128.62, 128.58, 128.52, 128.08, 127.98, 127.96, 117.12, 97.77 (C-1), 76.81 (C-3), 75.21 (C-2), 73.58, 72.97, 69.87 (C-5), 68.66 (C-4), 68.29, 33.86. IR (neat): 698, 737, 914, 1026, 1064, 1096, 1210, 1271, 1342, 1454, 1722, 2921, 3450. HR-MS:  $[\text{M}+\text{Na}^+]$  Calculated for  $\text{C}_{24}\text{H}_{28}\text{O}_7$ : 451.1727; found: 451.1725.

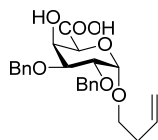

**5-(benzyl(benzyloxycarbonyl)amino)pentyl 2-azido-3-O-benzoyl- $\alpha$ -D-galactopyranose uronic acid (11b)**: This product was prepared following general procedure for selective oxidation of primary alcohol to carboxylic acid by use of two steps one-pot TEMPO/BAIB-Pinnick oxidation. TLC:  $R_f = 0.12$  (DCM:MeOH:AcOH = 20:2:0.05). Yield: 49 mg (0.079 mmol), 80%.  $^1\text{H}$  NMR (400 MHz,  $\text{CDCl}_3$ )  $\delta$  7.31 (dd,  $J = 32.5, 12.5$  Hz, 15H,  $\text{CH}_{\text{arom}}$ ), 5.17 (d,  $J = 14.4$  Hz, 2H,  $\text{PhCH}_2$ ), 4.97 (d,  $J = 11.8$  Hz, 1H, H-1), 4.79 – 4.59 (m, 2H,  $\text{PhCH}_2$ ), 4.49 (d,  $J = 11.0$  Hz, 3H, H-4,  $\text{PhCH}_2$ ), 4.37 (d,  $J = 14.6$  Hz, 1H, H-5), 3.93 (d,  $J = 11.3$  Hz, 1H, H-3), 3.77 – 3.51 (m, 2H, H-2), 3.54 – 3.31 (m, 1H), 3.22 (d,  $J = 25.7$  Hz, 2H), 1.69 – 1.41 (m, 3H), 1.40 – 1.24 (m, 3H).  $^{13}\text{C}$  NMR (100 MHz,  $\text{CDCl}_3$ )  $\delta$  137.83, 136.93 ( $\text{C}_q$ ), 128.76, 128.65, 128.39, 128.14, 128.05, 127.94, 127.42, 127.29 ( $\text{CH}_{\text{arom}}$ ), 98.26 (C-1), 75.22 (C-3), 71.97 (Bn), 70.01 (C-5), 68.97, 67.42 (Bn), 67.19 (C-4), 58.42 (C-2), 50.60, 50.33, 47.11, 46.17, 29.00, 27.88, 27.41, 23.28.  $[\alpha]^{20}_D = 75^\circ$  (c = 1.0,  $\text{CHCl}_3$ ). IR (neat): 698, 735, 1026, 1063, 1140, 1231, 1250, 1311, 1356, 1423, 1454, 1493, 1697, 2927. HR-MS:  $[\text{M}+\text{H}^+]$  Calculated for  $\text{C}_{33}\text{H}_{38}\text{N}_4\text{O}_8$ : 619.27624; found: 619.27602.

## 6.5 References

- [1] J. D. C. Codée, A. E. Christina, M. T. C. Walvoort, H. S. Overkleeft and G. A. van der Marel, (2010) Uronic Acids in Oligosaccharide and Glycoconjugate Synthesis. In: Fraser-Reid B., Cristóbal López J. (eds) Reactivity Tuning in Oligosaccharide Assembly. Topics in Current Chemistry, vol 301. Springer, Berlin, Heidelberg.
- [2] L. J. van den Bos, J. D. C. Codée, R. E. J. N. Litjens, J. Dinkelaar, H. S. Overkleeft and G. A. van der Marel, *Eur. J. Org. Chem*, **2007**, 3963-3976.
- [3] M. Nowogrodzki and J. Mlynarski, *Current Organic Chemistry*, **2014**, *18*, 1913-1934.
- [4] TEMPO-mediated oxidation, In: G. Tojo, M. I. Fernandez. (eds) Oxidation of primary alcohols to carboxylic acids a guide to current common practice, **2007**, XVI, 116p, Springer-Verlag New York.
- [5] P. L. Anelli, C. Biffi, F. Montanari, S. Quici, *J.Org.Chem*, **1987**, *52*, 2559-2562.
- [6] P. L. Bragd, A. C. Besemer and H. van Bekkum, *Journal of Molecular Catalysis A: Chemical*, **2001**, *170*, 35-42.

- [7] a) M. F. Semmelhack, C. S. Chou, D. A. Cortes, *J. Am. Chem. Soc.*, **1983**, *105*, 4492–4494; b) T. Inokuchi, S. Matsumoto, S. Torii, *J. Org. Chem.*, **1991**, *56*, 2416-2421; c) For a review, see: M. Yamaguchi, T. Miyazawa, Y. Takata, T. Endo, *Pure Appl. Chem.*, **1990**, *62*, 217-222; d) Y. Kashiwagi, Y. Yanagisawa, F. Kurashima, J. Anzai, T. Osa, J. M. Bobbit, *Chem. Commun.*, **1996**, 2745-2746.
- [8] a) J. A. Cella, J. A. Kelley, E. F. Kenhan, *J. Org. Chem.*, **1975**, *40*, 1860-1862; b) B. Ganem, *J. Org. Chem.*, **1975**, *40*, 1998-2000; c) J. A. Cella, J. P. McGrath, J. A. Kelley, O. El Soukary, L. Hilpert, *J. Org. Chem.*, **1977**, *42*, 2077-2080.
- [9] a) T. Miyazawa, T. Endo, *J. Mol. Catal.*, **1985**, *31*, 217-220; b) T. Miyazawa, T. Endo, *J. Mol. Catal.*, **1985**, *32*, 357-360; c) M. F. Semmelhack, C. R. Schmid, D. A. Cortes, C. S. Chou, *J. Am. Chem. Soc.*, **1984**, *106*, 3374-3376.
- [10] T. Inokuchi, S. Matsumoto, T. Nishiyama, S. Torii, *J. Org. Chem.*, **1990**, *55*, 462-466.
- [11] a) P. L. Anelli, S. Banfi, F. Montanari, S. Quici, *J. Org. Chem.*, **1989**, *54*, 2970-2972; b) R. Siedlecka, J. Skarzewski, J. Mlochowski, *Tetrahedron Lett.*, **1990**, *31*, 2177-2180; c) N. J. Davis, S. L. Flitsch, *Tetrahedron Lett.*, **1993**, *34*, 1181-1184. d) P. Bragd, H. van Bekkum, and A. Besemer, *Topics in Catalysis*, **2004**, *27*, 49-66; e) F. Lin, W. Peng, W. Xue, X. Han and B. Yu, *Carbohydr. Res.*, **2004**, *339*, 1219-1223.
- [12] a) L. De Luca, G. Giacomelli, S. Masala, A. Porcheddu, *J. Org. Chem.*, **2003**, *68*, 4999-5001; b) D. J. Chambers, G. R. Evans, A. J. Fairbanks, *Tetrahedron*, **2005**, *61*, 7184-7192.
- [13] A. De Mico, R. o Margarita, L. Parlanti, A. Vescovi and G. Piancatelli, *J. Org. Chem.*, **1997**, *62*, 6974-6977.
- [14] J. B. EPP and T. S. Widlanski, *J. Org. Chem.*, **1999**, *64*, 293-295.
- [15] a) L. J. van den Bos, J. D. C. Codée, J. C. van der Toorn, T. J. Boltje, J. H. van Boom, H. S. Overkleeft, G. A. van der Marel, *Org. Lett.*, **2004**, *6*, 2165-2168; b) L. J. van den Bos, R. E. J. N. Litjens, R. J. B. H. N. van den Berg, H. S. Overkleeft, G. A. van der Marel, *Org. Lett.*, **2005**, *7*, 2007-2010.
- [16] L. Huang, N. Teumelsan and X.F. Huang, *Chem. Eur. J.*, **2006**, *12*, 5246-5252.
- [17] a) B. Hagen, J. Hessel, M. van Dijk, Q.J. Zhang, H.S. Overkleeft, G.A. van der Marel and J.D.C. Codée, *Org. Lett.*, **2017**, *19*, 2514-2517; b) chapter 7.
- [18] a) B. O. Lindgren, T. Nilsson, *Acta Chemica Scandinavica*, 1973, pp 888-890; b) B. S. Bal, W. E. Childers, H. W. Pinnick, *Tetrahedron*, **1981**, *37*, 2091-2096.
- [19] The synthesis and data of this compound see chapter 7.
- [20] Chung-sing Wong, PhD Thesis, Leiden university, 2015, p122.



# 7

## Total Synthesis of Zwitterionic SP1 Oligosaccharides

### 7.1 Introduction

Zwitterionic polysaccharides (ZPSs) are found on the surface of *Bacteroides fragilis* and *Streptococcus pneumoniae* and they exhibit unique immunomodulatory properties.<sup>[1]</sup> ZPSs are the only known carbohydrate antigens to induce an immune response by a T cell-dependent pathway.<sup>[2]</sup> They are taken up by antigen presenting cells, processed and loaded in major histocompatibility complex class II (MHC-II) molecules and presented to T-cells.<sup>[2]</sup> To understand the mechanism of their immunomodulatory activity, get a detailed picture how these unique polysaccharides bind MHC-II molecules and their T-cell receptors, and eventually develop a synthetic vaccine, well-defined oligosaccharides of ZPSs are needed. The synthesis of ZPSs oligosaccharides represents a major challenge because of the presence of rare monosaccharide constituents, such as the trideoxy-diaminogalactose residues, the 1,2-*cis*-glycosidic bonds, and the presence of both positive

and negative charges in the molecules.<sup>[3]</sup> This Chapter describes the assembly of oligosaccharides of the capsular polysaccharide of *Streptococcus pneumoniae* type 1 (Sp1), composed of 1,2-*cis*-linked 2,4,6-trideoxy-2-*N*-acetamido-4-amino- $\alpha$ -D-galactopyranose (TDDAG) and galacuronic acid residues (See Figure 7.1), up to the dodecamer level, the longest zwitterionic polysaccharide fragment synthesized to date.

## 7.2 Results and discussion

### 7.2.1 Synthetic approach

Chapter 2 reviewed the synthetic work, reported to date, directed at the assembly of the zwitterionic polysaccharides PS A1 and Sp1.<sup>[3]</sup> The described Sp1 syntheses clearly illustrate the challenges associated with the assembly of these molecules: the generation of sufficient amounts of the rare 2,4,6-trideoxy-2-*N*-acetamido-4-amino- $\alpha$ -D-galactopyranose (TDDAG) residues, effecting high yielding and stereoselective *cis*-glycosylations and effectively installing the uronic acid residues. The longest ZPS assembled to date was reported by Bundle and co-workers who assembled an Sp1-hexasaccharide (*i.e.* two repeating units). They described that extensive optimizations were required for the construction of the glycosidic linkages.<sup>[4]</sup> Christina *et al.* assembled all three possible repeating units of the Sp1 polysaccharide using galacturonic acid lactone building blocks. Although these synthons are very effective for the stereoselective installation of 1,2-*cis*-linkages, construction of the crucial linkage between the two galacturonic acid residues failed and a 5:4  $\alpha/\beta$ -mixture was obtained.<sup>[5]</sup> Seeberger *et al.* and co-workers described the assembly of a spacer-equipped Sp1-trisaccharide but also did not succeed in the stereoselective construction of the  $\alpha$ -galacturonic acid residues.<sup>[6]</sup>

All these syntheses clearly indicate the stereoselective construction of the glycosidic linkages as a major bottle neck.

One of the most powerful means to introduce 1,2-*cis*-galactosyl linkages in a stereoselective manner reported to date, builds on the use of 4,6-silylidene protected galactose configured building blocks. The bulky silyl protecting group effectively shields the top face of the galactose ring thereby guiding the incoming nucleophile to the  $\alpha$ -face. The stereodirecting effect of the 4,6-silylidene is in fact so strong that it overrides the generally very powerful neighboring group participation from an acyl protecting group at the C2-hydroxyl or amine functionality.<sup>[7]</sup> It was therefore decided to employ the silylidene strategy to construct the Sp1 oligosaccharides as retrosynthetically depicted in figure 7.1 using trisaccharide **13/14** as the key building block. The simultaneous oxidation of multiple alcohols can be extremely difficult<sup>[4,8]</sup> and it was therefore planned to already install one of the uronic acid residues in the trisaccharide building block, before the assembly of longer oligomers. From previous syntheses it has also become apparent that the removal of a protecting group at the TDDAG C-3-OH under basic conditions leads to formation of the C-3, N-4 carbamate,<sup>[5,6]</sup> both levulinoyl (Lev) ester- and benzyloxymethyl (BOM) ether protected building blocks (**13** and **14**, respectively) are investigated. For future functionalization, a 3-butenol moiety, was installed, as the double bond in this spacer can be functionalized in a mild and chemoselective manner using a thiol-ene reaction.<sup>[9]</sup> The key trisaccharides donors **13** and **14** were synthesized from monosaccharide **15-18** which were produced from D-mannose and D-galactose in 7-15 steps.

Figure 7.1 Retrosynthesis analysis of zwitterionic SP1 oligosaccharides (1, 2, 3 and 4).

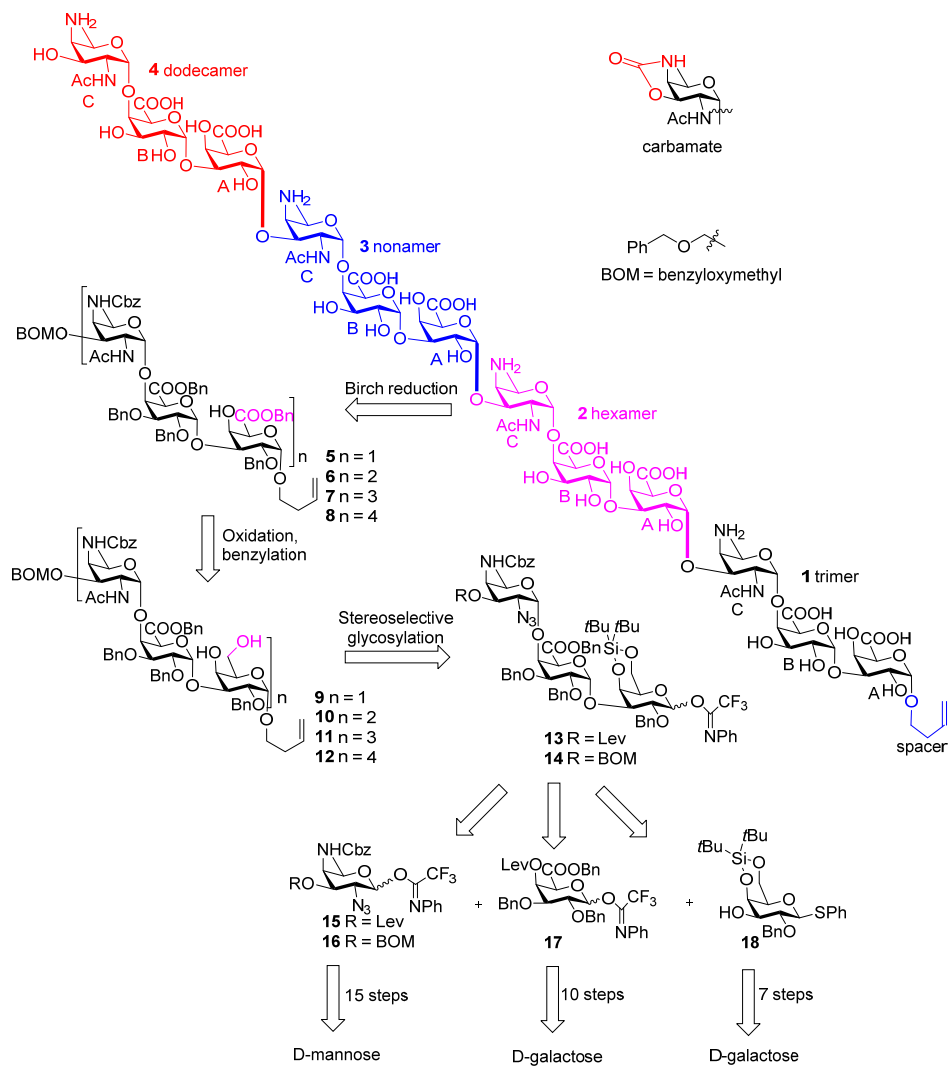



### 7.2.2 Synthesis of zwitterionic SP1 oligosaccharides (**1**, **2**, **3** and **4**).

The synthesis of the TDDAG donors **15** and **16** is depicted in Scheme 7.1. Following Kulkarni's protocol,<sup>[10]</sup> the syntheses started from D-mannose, to give, after 7 steps, phenyl 3-*O*-benzoyl-6-deoxy-1-thio- $\beta$ -D-mannose **19a**. Triflation of both alcohols in **19a**, regioselective substitution of the C-2-*O*-triflate using tetrabutyl ammonium azide (TBAN<sub>3</sub>), and consecutive replacement of the C-4-*O*-triflate for an *N*-phthalimide functionality provided the TDDAG building block **22a** in 48% yield. Unfortunately, the removal of the benzoate ester and phthaloyl groups and installation of the carboxylbenyl (Cbz) carbamate at the liberated C-4-amine proceeded in very low yield. To increase the overall efficiency the benzoate in **19b** was replaced for an acetyl ester. Although **19b** was obtained in a moderate yield (30% over three steps), the subsequent steps proceeded in a reliable manner to produce **23** in 69% yield. The free alcohol in **23** was protected with a Lev-ester or BOM-ether to yield **24** and **26**, respectively. Hydrolysis of the thioacetal (to give **25** and **27**) and installation of the *N*-phenyltrifluoroacetimidate group then gave donors **15** and **16**, respectively.

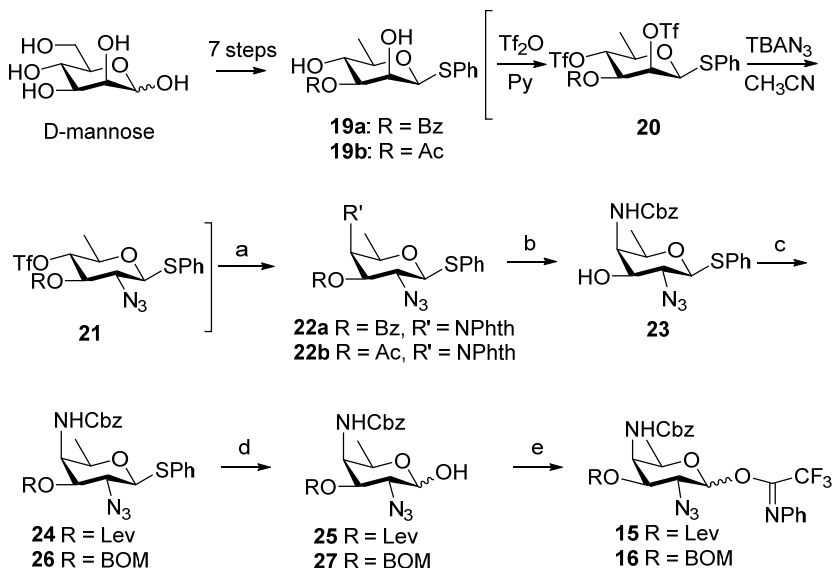
Scheme 7.1 Synthesis of 2,4,6-trideoxy-raregalactose donors **15** and **16**.

Reagents and conditions: (a) PhthNK, DMF, **22a**: 48% (over three steps); **22b**: 30% (over three steps).

(b) i. ethylenediamine, butanol, reflux; ii. CbzCl, NaHCO<sub>3</sub>, THF/H<sub>2</sub>O, from **22b**: 69% (over two steps). (c) For **24**: LevOH, EDCI, DIPEA, DMAP, DCM, 91%; for **26**: BOMCl, DIPEA, TBAI, DCM, 79%. (d) NIS, TFA, DCM, **25**: 100%; **27**: 97%. (e) *N*-phenyltrifluoroacetimidoyl chloride, K<sub>2</sub>CO<sub>3</sub>, acetone, **15**: 79%, **16**: 88%.

The synthesis of the galacturonic acid donor **17** and galactose building block **18** is depicted in Scheme 7.2. Phenyl 2,3,4,6-tetra-*O*-acetyl-1-thio- $\beta$ -D-galactopyranoside **28**, synthesized from D-galactose, was transformed into diol **29** in four steps (86% yield). Regio- and chemoselective oxidation of the C-6-OH was accomplished by a TEMPO/BAIB-mediated oxidation to provide, after benzylation of the resulting acid, galacturonic acid **30**. Donor **17** was accessed by levulinoylation (to give **31**), hydrolysis of the thioacetal (to give **32**), and installation of the *N*-phenyltrifluoroacetimidate group. To acquire silylidene galactoside **18**, **28** was first transformed into mono-alcohol **33**.<sup>[11]</sup> Benzylation of the free alcohol and acid mediated liberation of the other alcohols then provided **34** in 56% yield

(over four steps). Installation of the di-*tert*-butylsilylidene group proceeded uneventfully to give the last monosaccharide synthon **18**.

**Scheme 7.2** Synthesis of galacturonic acid donor **17** and silylidene galactose **18**.

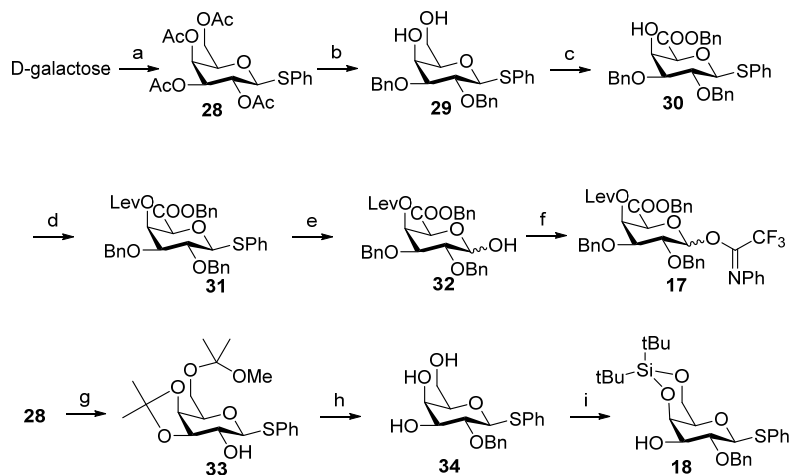

*Reagents and conditions:* (a) i. Ac<sub>2</sub>O, catalytic amount H<sub>2</sub>SO<sub>4</sub>, 0 °C to rt; ii. Thiophenol, BF<sub>3</sub>•OEt<sub>2</sub>, DCM, 70% (over two steps). (b) i. NaOMe, MeOH, rt, overnight; ii. Benzaldehyde dimethyl acetal, camphorsulfonic acid, CH<sub>3</sub>CN, rt, 24 h; iii. NaH, BnBr, DMF, overnight; iv. MeOH, TsOH•H<sub>2</sub>O, overnight, 86% (over four steps). (c) i. TEMPO, BAIB, DCM/tBuOH/H<sub>2</sub>O, 4 °C, overnight; ii. BnBr, CsCO<sub>3</sub>, DMF, 67% (over two steps). (d) LevOH, EDCI, DIPEA, DMAP, DCM, 97%. (e) NIS, TFA, DCM, 81%. (f) *N*-phenyltrifluoroacetimidoyl chloride, K<sub>2</sub>CO<sub>3</sub>, acetone, 93%. (g) i. NaOMe, MeOH, rt, overnight; ii. Dimethoxypropane, CSA, rt, 48 h. (h) i. NaH, BnBr, DMF, overnight; ii. 80% AcOH, 70 °C, 3 h, 56% (over two steps). (i) Di-*tert*-butylsilyl bis(trifluoromethanesulfonate), pyridine, 89%.

With all required monosaccharide building blocks in hand, Sp1 trisaccharide **1** was assembled to probe all of the chemical transformations required for the generation of the larger target oligosaccharides (Scheme 7.3). First, galacturonic acid **17** and silylidene galactose **18** were combined to assemble disaccharide **35**. After several optimization attempts with different catalysts, molecular sieves and work-up procedures, disaccharide **35** was produced in good yield and selectivity (77%,  $\alpha:\beta = 13:1$ ) by use of TfOH as catalyst,

5Å molecular sieves at low temperature and finally quenching with sat aq. NaHCO<sub>3</sub> (If the reaction was quenched with Et<sub>3</sub>N or pyridine, some byproducts were formed for unclear reasons ). From **35**, disaccharide acceptor **36** was accessed by delevulinoylation of the C-4-OH to set the stage for the assembly of the trisaccharide. Unfortunately, the glycosylation of disaccharide acceptor **36** with the TDDAG donor **16** provided the desired trimer (**37**) in low yield (25%) and with poor selectivity ( $\alpha:\beta = 2.9:1$ ). The trimer of which the BOM had been removed (**38**) was isolated as a major side product. Gratifyingly, when levulinoyl TDDAG donor **15** was coupled with disaccharide acceptor **36**, trisaccharide **39** was obtained in good yield and selectivity (85%,  $\alpha:\beta = 13:1$ ). From **39**, the key trisaccharide donor **13** was obtained by hydrolysis of the thioacetal and installation of *N*-phenyltrifluoroacetimidate group.

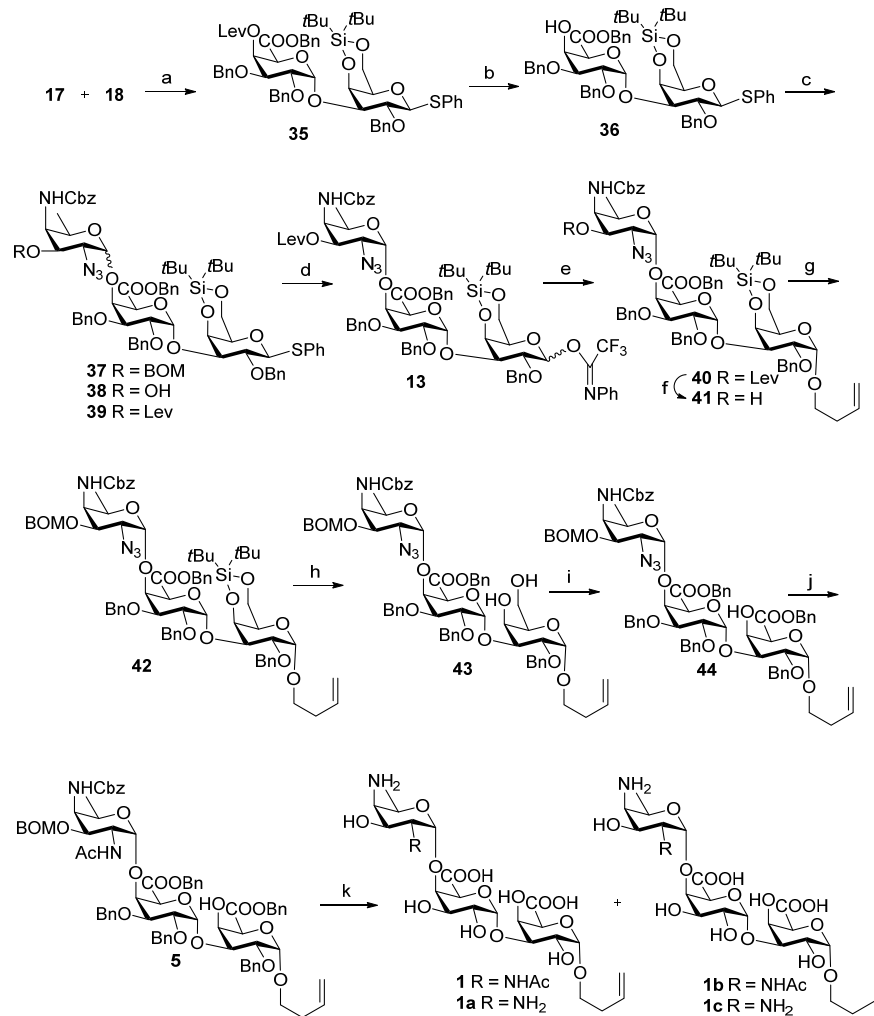
Scheme 7.3 Synthesis of trisaccharide **1**.

*Reagents and conditions:* (a) TFOH, DCM, -78 °C, 6 h, 77%,  $\alpha:\beta = 13:1$ . (b) N<sub>2</sub>H<sub>4</sub>•H<sub>2</sub>O, pyridine, AcOH, 0 °C to rt, 20 min, 89%. (c) donor **16**, TBSOTf, DCM, 0 °C, overnight, **37**: 25%,  $\alpha:\beta = 2.9:1$  and **38**: 29%,  $\alpha$  only, total yield 54%; or donor **15**, TBSOTf, DCM, 0 °C, 4 h, **39**: 85%,  $\alpha:\beta = 13:1$ . (d) i. NIS, TFA, DCM, 96%; ii. *N*-phenyltrifluoroacetimidoyl chloride, K<sub>2</sub>CO<sub>3</sub>, acetone, 89%. (e) Allylcarbinol, TBSOTf, DCM, 0 °C, 3 h, 82%,  $\alpha$  only. (f) N<sub>2</sub>H<sub>4</sub>•H<sub>2</sub>O, pyridine, AcOH, 0 °C to rt, 20 min, 98%. (g) BOMCl, DIPEA, TBAI, DCM, 89%. (h) HF/Py, pyridine, THF, 0 °C to rt, 20 min, 94%. (i) i. TEMPO, BAIB, DCM/tBuOH/H<sub>2</sub>O, 4 °C, overnight; ii. CsCO<sub>3</sub>, BnBr, DMF, 0 °C to rt, overnight, 84%. (j) AcSH, pyridine, rt, 20 h, 66%. (k) Birch reduction, see Table 7.1.

The glycosylation of the key trisaccharide donor **13** with allylcarbinol to install the spacer formed **40** in excellent yield and selectivity (82%,  $\alpha$  only), indicating the apt glycosylating properties of the trisaccharide donor. The fully protected trimer was then transformed into diol **43** by exchange of the C-3''-*O*-Lev ester **40** for a BOM ether and removal of the silylidene ketal. Regioselective TEMPO/BAIB oxidation of C-6 proceeded uneventfully to provide the carboxylic acid, which was benzylated to give trimer **44**. Global deprotection of this trimer was accomplished as follows. First, the azide was transformed into the corresponding acetamido unit using thio acetic acid to give **5**.<sup>[12]</sup> Next the benzyl esters were saponified to provide the dicarboxylate for the final birch-type reduction,<sup>[6,13]</sup> by which the remaining benzyl, Cbz and BOM protecting groups should be removed. The successful removal of all these masking groups however proved challenging and the first attempt (See Table 7.1, Entry 1), using sodium in ammonia and THF, delivered a mixture of products **1a**, in which the *N*-acetyl had been removed and **1c** of which the butene double bond had been reduced. The addition of *tert*-butanol to the reaction mixture successfully prevented the deacetylation (Table 7.1, Entry 2) and delivered the desired trimer **1** and its butanol counterpart **1b** in a 7:1 ratio, in 75% combined yield. To prevent reduction of the C-C double bond, allylcarbinol was used as a scavenger. This improved the reaction further to give the desired trisaccharide **1** and only a minor amount of the saturated side product **1b** in excellent yield (95%, Entry 3). The addition of more allylcarbinol did not improve the reaction (Entry 4), nor did the use of lithium instead of sodium (Entry 5).

**Table 7. 1** The conditions for Birch reduction of trisaccharide.

Entry	SM	tBuOH	Na/Li	Additive	Time	Ratio <sup>[a]</sup>	Ratio <sup>[b]</sup>	Product (Yield)
1	<b>5</b>	No	Na	No	25min	6:1	0:1	<b>1a,1c</b> (55%)
2	<b>5</b>	0.8 ml	Na	No	10min	7:1	1:0	<b>1,1b</b> (74%)
3	<b>5</b>	0.8 ml	Na	(50 ul)	25min	14:1	1:0	<b>1,1b</b> (95%)
4	<b>5</b>	0.8 ml	Na	(500 ul)	25min	10:1	1:2	<b>1,1a,1b,1c</b> (83%)
5	<b>5</b>	0.8 ml	Li	(50 ul)	25min	5.7:1	5:1	<b>1,1a,1b,1c</b> (85%)

a. The ratio of (**1+1a**, with C=C):(b+1c, without C=C); b. (**1+1b**, with Ac):(1a+1c, without Ac).

With the successful synthesis of trisaccharide **1** and the chemistry established to accomplish all the required transformations, the assembly of the larger oligomers **2-4** was undertaken as depicted in Scheme 7.4. First, trisaccharide acceptor **41** was condensed with trimer donor **13** to give the required hexasaccharide **45** with excellent yield and stereoselectivity (83%,  $\alpha$  only). The hexamer **45** was delevulinoylated (to give **46**) and coupled with **13**, to provide the nonasaccharide **47** in equally good yield and stereoselectivity (80%,  $\alpha$  only). Finally, the nonamer **47** was elongated in a subsequent delevulinoylation-glycosylation sequence to deliver the desired dodecasaccharide **49** in 72% yield. Also, in this glycosylation the desired  $\alpha$ -product was formed as the sole anomer, showing the effectiveness of the silylidene donor and glycosylation strategy devised. The only side product that was formed during the latter glycosylations was the 1,1-coupled hexasaccharide **59**. This byproduct was used to optimize reaction conditions for the steps to come, as described below and the fully deprotected 1,1'-linked hexasaccharide will serve as a control substance in future biological evaluation studies. Hexamer **45**, nonamer **47** and dodecamer **49**, were next transformed into the oxidation precursors **10**, **11** and **12** by removal of the levulinoyl ester, installation of the BOM ether (to give **51**, **52** and **53**, respectively), and the conversion of the azides to their corresponding acetamido units. For

the larger oligosaccharides, the AcSH-mediated method did not proceed well and therefore a Staudinger reaction was used to reduce the azides and liberate the amines.<sup>[14]</sup>

Acetylation then gave **54**, **55** and **56**, respectively, which were desilylated to provide **10**, **11** and **12**. Following the same reaction sequence, 1,1'-linked hexasaccharide **60** was obtained from **59**.

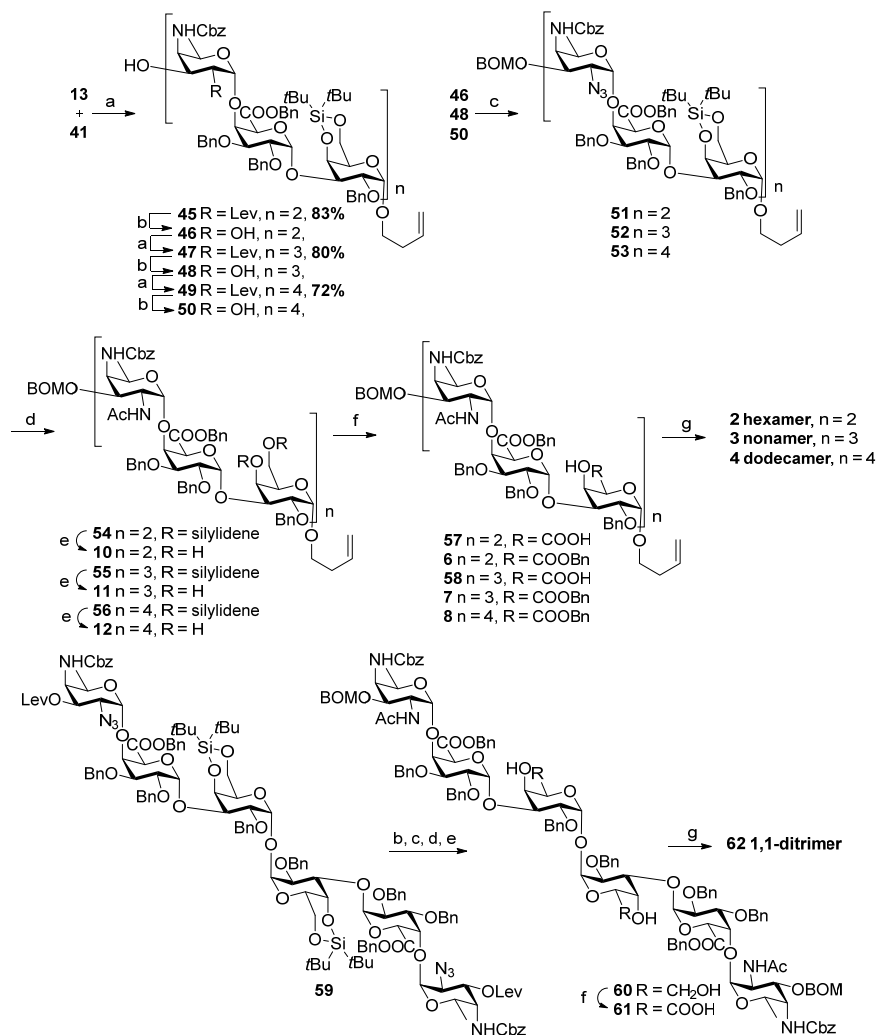

Scheme 7.4 Synthesis of hexasaccharide **10**, nonasaccharide **11**, **57** and dodecasaccharide **13**.

*Reagents and conditions:* (a) TBSOTf, DCM, 0 °C, **45**: 83%,  $\alpha$  only; **47**: 80%,  $\alpha$  only; **49**: 72%,  $\alpha$  only. (b) N<sub>2</sub>H<sub>4</sub>•H<sub>2</sub>O, pyridine, AcOH, 0 °C to rt, 20 min, **46**: 97%; **48**: 89%; **50**: 91%. (c) BOMCl, DIPEA, TBAI, DCM, **51**: 81%; **52**: 89%; **53**: 84%. (d) i. PPh<sub>3</sub>, pyridine, H<sub>2</sub>O, THF, reflux, 7 h; ii. Ac<sub>2</sub>O, pyridine, rt, overnight, **54**: 93%; **55**: 88%; **56**: 99%. (e) HF/Py, pyridine, THF, 0 °C to rt, 20 min, **10**: 91%; **11**: 88%; **12**: 91%; **60**: 93%. (f) oxidation see table 6. (g) i. 1 M NaOH, THF, MeOH, 0 °C to rt, 2 d; ii. Birch reduction, **62**: 31%; **2**: 39%; **3**: 55%; **4**: 47% (yield for two steps).

Although the TEMPO/BAIB oxidation was effective in the synthesis of trisaccharide **1**, it failed in the assembly of the larger oligosaccharides (Table 7.2, Entry 1), underscoring the difficulty in affecting multiple simultaneous oxidation reactions. Chapter 6 described a new two-step one-pot TEMPO/BAIB-Pinnick oxidation protocol for the selective oxidation of primary alcohols to the corresponding carboxylic acids. It was shown that this protocol not only works well on glucose-, galactose-, gulose- and mannose-based monosaccharide building blocks, but also on more complex oligosaccharides, where the 'classic' TEMPO/BAIB conditions failed. Thus, 1,1'-linked hexasaccharide **60** was used as a model substrate to explore this oxidation strategy. Following the two-step oxidation sequence,<sup>[8c]</sup> the required di-carboxylic acid **61** was obtained in 85% yield (Table 7.2, Entry 2). Using this method, the hexamer **10** was successfully transformed into carboxylic acid **57** in 63% yield. Benzylation of the two carboxylates in **57** then provided fully protected hexasaccharide **6** in 67% yield (Entry 3). Unfortunately, the oxidation of the three alcohols in nonamer **11** could not be accomplished using the TEMPO/BAIB-Pinnick reaction sequence, and a complex product mixture was obtained (Entry 4).

It has previously been shown that efficiency of TEMPO mediated oxidations can be significantly improved under basic conditions.<sup>[15]</sup> Presumably, this accelerates the formation of the hydrate from the intermediately formed aldehyde. To test whether basic conditions could improve the challenging oxidations reactions, required here, model hexasaccharide **60** was subjected to TEMPO/BAIB treatment in the presence of NaHCO<sub>3</sub>. Under these conditions the dicarboxylic acid **61** was obtained in 73% yield (Entry 5). Satisfyingly, also hexamer **10** and nonasaccharide **11** could be transformed into the desired di- and tricarboxylic acids, respectively. After benzylation of the tricarboxylic acid,

nonasaccharide **7** was obtained in 51% yield (over two steps, Entry 7). Application of this protocol to the most complex substrate, oligosaccharide dodecamer **12**, delivered, after benzylation using benzylbromide and  $K_2CO_3$ , dodecamer **8** in only 19% yield over the two steps (Entry 8). To further improve on the protocol, milder and more efficient benzylation conditions, using phenyldiazomethane,<sup>[8b,16]</sup> were used. Using these conditions, dodecasaccharide **8** was obtained in 49% over the two steps (Entry 9). To complete the syntheses of hexamer **2**, nonamer **3**, dodecamer **4** and 1,1-linked hexasaccharide **61** the oligosaccharides were deprotected by saponification of the benzyl esters and final Birch reaction to provide the target oligomers in 39% (for **2**), 55% (for **3**), 47% (for **4**) and 31% (for **61**) yield, respectively.

**Table 7.2** The oxidation benzylation of hexasaccharide, nonasaccharide and dodecasaccharide.

entry	SM	reagents	solvent	Temp	Time	Product/yield for oxidation	Product/yield of benzylation
1	<b>10</b>	TEMPO/BAIB (0.2 eq /2,5 eq)	DCM/tBuOH/H <sub>2</sub> O	4 °C	12h	failed	
2	<b>60</b>	TEMPO/BAIB-Pinnick oxidation	THF/DCM	rt	2d	<b>61</b> /85%	
3	<b>10</b>	TEMPO/BAIB-Pinnick oxidation	THF/DCM	rt	2,5d	<b>57</b> /63%	<b>6</b> /67%
4	<b>11</b>	TEMPO/BAIB-Pinnick oxidation	THF/DCM	rt	2d	failed	
5	<b>60</b>	TEMPO/BAIB (0.4 eq /2.5 eq), NaHCO <sub>3</sub>	EA/tBuOH/H <sub>2</sub> O	4 °C	4d	<b>61</b> /73%	
6	<b>10</b>	TEMPO/BAIB (0.8 eq /4.0 eq), NaHCO <sub>3</sub>	EA/tBuOH/H <sub>2</sub> O	4 °C	3d	<b>57</b> /67%	<b>6</b> /67%
7	<b>11</b>	TEMPO/BAIB (0.8 eq /5.0 eq), NaHCO <sub>3</sub>	EA/tBuOH/H <sub>2</sub> O	4 °C	4d	<b>58</b> /89%	<b>7</b> /57%
8	<b>12</b>	TEMPO/BAIB (0.6 eq /5.0 eq), NaHCO <sub>3</sub>	EA/tBuOH/H <sub>2</sub> O	4 °C	5d		<b>8</b> /19%
9	<b>12</b>	TEMPO/BAIB (0.6 eq /5.0 eq), NaHCO <sub>3</sub>	EA/tBuOH/H <sub>2</sub> O	4 °C	5d		<b>8</b> /49%

### 7.2.3 Structural analysis of ZPS-Sp1 oligosaccharides

It has been proposed that the secondary structure of ZPSs is of crucial importance to their activity. Both the PS A1 and Sp1 polysaccharides can take up helical shapes and it has been suggested that these structures position the negative and positive charges, present in the polysaccharide fragments, properly in space to effectively interact with MHC-II molecules.<sup>[16]</sup> To compare the structures of the here synthesized oligosaccharides to the polysaccharide, obtained from natural sources, Figure 7.2A and 7.2B provide the <sup>1</sup>H and <sup>13</sup>C spectra of the generated compounds as well as the <sup>1</sup>H NMR spectrum of the native Sp1.<sup>[17b]</sup> As the <sup>13</sup>C NMR spectrum of the Sp1 polysaccharide is not available, the <sup>13</sup>C NMR resonances that have been reported in a previous study, obtained from HMQC experiments,<sup>[17b]</sup> are used for comparison. When the <sup>1</sup>H NMR spectra of trimer **1**, hexamer **2**, nonamer **3**, dodecamer **4** and native Sp1 are compared (Figure 7.2.A), it becomes clear that the <sup>1</sup>H resonances of the internal sugar residues of the nonamer **3** and dodecamer **4** correspond well with the resonances of the native Sp1 polysaccharide. The resonances of the terminal residues and the trisaccharide **1** differ significantly. In the spectra of hexamer **2** and nonamer **3**, the resonances corresponding to H-4 and H-5 of the 2,4,6-trideoxy-2-*N*-acetamido-4-amino- $\alpha$ -D-galactopyranose appear as broad signals. This may either indicate that the residues are relatively flexible and can adopt several low energy conformations, or the presence of different *N*-acetyl rotamers. When the <sup>13</sup>C NMR spectra of trimer **1**, hexamer **2**, nonamer **3**, dodecamer **4** and native Sp1 are compared (Figure 7.2B), a similar picture emerges: the resonances of nonamer **3** and dodecamer **4** are well in agreement with those reported for the native Sp1, except for the peaks from terminal residues. The signals for the C4 and C5 carbons of the TDDAG residues show significant broadening.

**Figure 7.2. A)**  $^1\text{H}$  NMR spectra of Sp1 oligosaccharides (**1**, **2**, **3** and **4**) and native Sp1 polysaccharide <sup>[17b]</sup>  
**B)**  $^{13}\text{C}$  NMR spectra of oligosaccharides (**1**, **2**, **3** and **4**) and the  $^{13}\text{C}$  NMR-resonances of the native Sp1 polysaccharide <sup>[17b,17c]</sup>

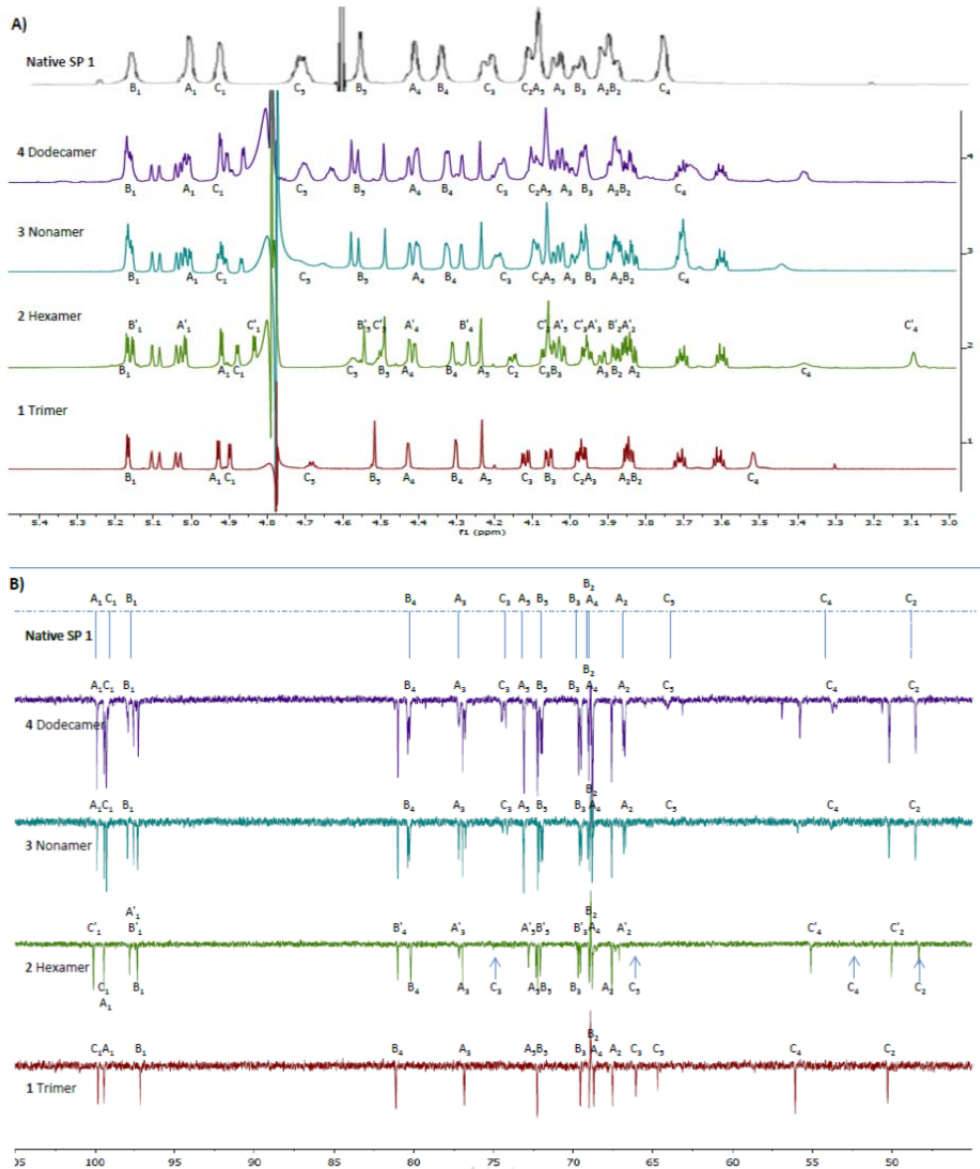

Because 2-D NOESY spectra can provide information on the 3D-structure of molecules, NOESY spectra of trimer **1**, hexamer **2**, nonamer **3**, dodecamer **4** were recorded and compared to the NOESY spectrum of the native Sp1 polysaccharide. In Figure 7.3A and 7.3B the NOESY spectrum of dodecasaccharide **4** and the native Sp1 are depicted, respectively. Figure 7.3C shows the structure of the dodecasaccharide with selected NOESY interactions. Characteristic intraresidue (within the same monosaccharide) and interresidue (between adjacent residues) NOESY cross-peaks are apparent. For example a strong intraresidual cross-peak is observed for the axial C-3 and C-5 protons of the galacturonic acid (sugar A and B, see Figure 7.3A, cross-peaks cp9 and cp10). Within the TDDAG residue (sugar C) strong cross-peaks were not only observed for the protons at C-3 and C-5 (Figure 7.3A, cp11), but also the protons at the C-2 and C-3 (Figure 7.3A, cp12). The following strong interresidue cross-peaks were observed:  $H_{C1}$  with  $H_{B4}$ , (cp1),  $H_{B1}$  with  $H_{A3}$  (cp 4),  $H_{A1}$  with  $H_{C3}$  (cp5),  $H_{B1}$  with  $H_{A4}$  (cp2),  $H_{A1}$  with  $H_{C4}$  (cp3). The NOESY spectrum of dodecamer **4** also nicely matches the simulated NOESY spectrum of the Sp1 polysaccharide, that was used to establish the secondary helical structure of the polysaccharide. Altogether these preliminary structural studies indicate that the longer structures (the nona- and dodecasaccharide **3** and **4**) resemble the native polysaccharide. Further studies have to establish whether the nona- and dodecasaccharides can indeed take up a helical structure to properly mimic the native polysaccharide.

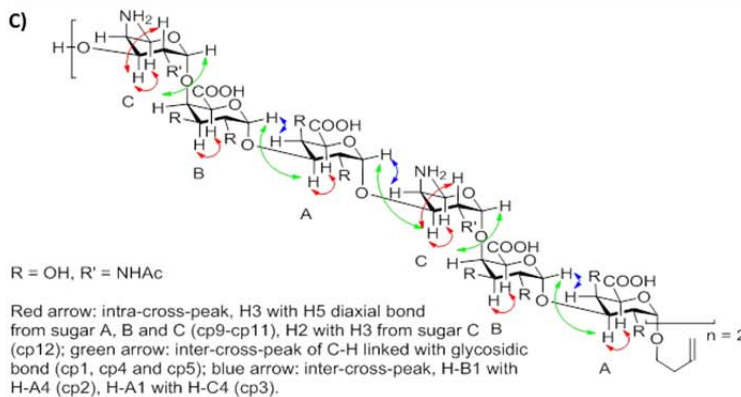
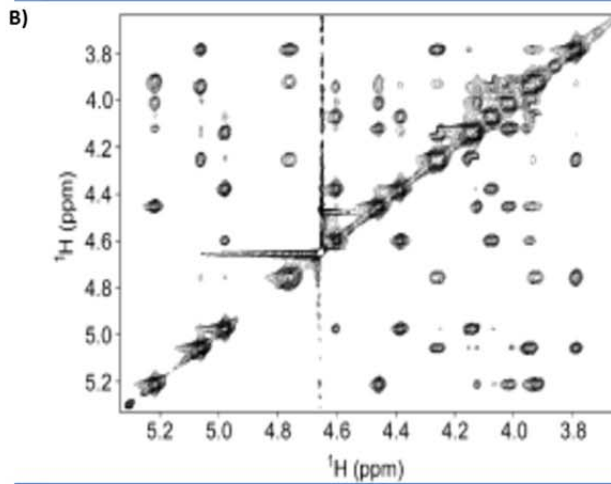
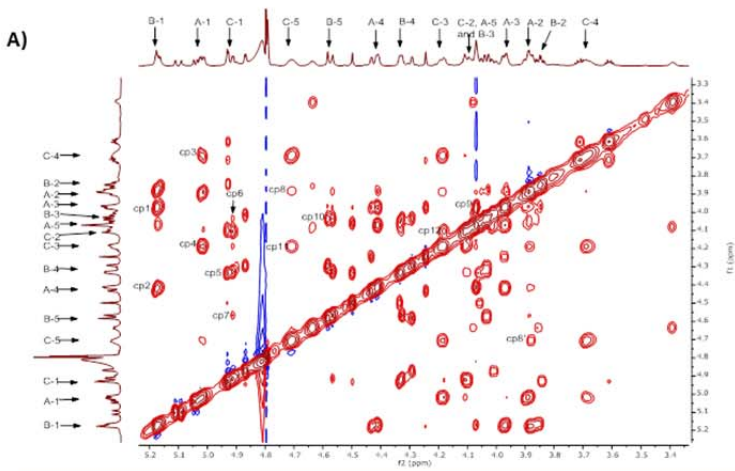
Figure 7.3 NOE spectrum of dodecamer **4** (with selected NOESY interactions) and native SP1<sup>[17b]</sup>

### 7.3 Conclusion

This Chapter has described the first synthesis of long zwitterionic oligosaccharides corresponding to the *Streptococcus pneumonia* type 1 polysaccharide. The successful syntheses were built on the use of trisaccharide building blocks, featuring a silylidene protected galactose donor-part to ensure complete stereoselectivity in the construction of the *cis*-linkages between the repeating units. The uronic acid moiety of the middle galacturonic acid residue was installed in the trisaccharide building blocks, to avoid the necessity of many simultaneous oxidation events at the end of the assembly. Indeed, the simultaneous oxidation of three or four primary alcohols at the nona- and dodecasaccharide stage, respectively, already proved to be extremely challenging. A new TEMPO/BAIB oxidation protocol in basic milieu was set up to enable the generation of the oligo-acids. A mild and chemoselective benzylation reaction, entailing the use of phenyldiazomethane, allowed for the effective generation of four benzyl esters in the dodecasaccharide. It is envisaged that the here-developed oxidation-benzylation protocol can be applied in the assembly of many complex uronic acid containing oligosaccharides. Initial structural analyses indicate that the longer oligosaccharides may start to resemble the native polysaccharide. The availability of the large ZPS structures opens up the way to study the interaction with MHC-II molecules at the molecular level. This will finally show how a MHC molecule presents a sugar to the outside world to set T-cell signaling in motion.



## 7.4 Experimental section

### General experimental procedures

All reagents were of commercial grade and used as received. All moisture sensitive reactions were performed under an argon atmosphere. DCM used in the glycosylation was distilled over  $P_2O_5$  and stored on activated 5Å molecular sieves before being used. Reactions were monitored by TLC analysis with detection by UV (254 nm) and where applicable by spraying with 20% sulfuric acid in EtOH or with a solution of  $(NH_4)_6Mo_7O_{24} \cdot 4H_2O$  (25 g/L) and  $(NH_4)_4Ce(SO_4)_4 \cdot 2H_2O$  (10 g/L) in 10% sulfuric acid (aq.) followed by charring at  $\sim 150$  °C. Flash column chromatography was performed on silica gel (40-63µm).  $^1H$  and  $^{13}C$  spectra were recorded on a Bruker AV 400, AV 500, AV 600 or AV 850 in  $CDCl_3$ ,  $D_2O$ ,  $CD_3CN$ , MeOD. Chemical shifts ( $\delta$ ) are given in ppm relative to tetramethylsilane as internal standard ( $^1H$  NMR in  $CDCl_3$ ) or the residual signal of the deuterated solvent. Coupling constants ( $J$ ) are given in Hz. All  $^{13}C$  spectra are proton decoupled. NMR peak assignments were made using COSY and HSQC experiments. Where applicable NOESY, HMBC and HMBCCipvGATED experiments were used to further elucidate the structure. The anomeric product ratios were analysed through integration of proton NMR signals.

### General procedure for hydrolysis of thioglycosidic bond

NIS (5.0 mmol) and TFA (462 µl, 6.0 mmol) were added to a solution of thioglycoside (5.0 mmol) in  $CH_2Cl_2$  (40 ml) at 0 °C. After analysis by TLC showed complete consumption of the starting material, the reaction was quenched with  $Et_3N$ . Saturated  $Na_2S_2O_3$  (aq) was added to the reaction mixture, which was then stirred for 30 min. The aqueous layer was extracted twice with  $CH_2Cl_2$  and concentrated *in vacuo*. Purification by column chromatography yielded hydrolyzed product as a colourless oil in good yield.

### General procedure for the synthesis of *N*-phenyl-trifluoroacetimidate donors

The starting hemiacetal (8 mmol) was dissolved in acetone (75 ml) and the solution was cooled to 0 °C. *N*-phenyl-trifluoroacetimidoyl chloride (12 mmol) and cesium carbonate (8 mmol) were added and the resulting suspension was stirred overnight at room temperature. Then  $Et_3N$  was added to the reaction mixture, after which it was filtered and the filtrate was concentrated *in vacuo*. Purification by column chromatography (silica gel, pentane/EtOAc/ $Et_3N$ , 20/1/trace, v/v/trace) yielded *N*-phenyl-trifluoroacetimidate donor in good yield.

### General procedure for delevulinoylation

The starting material was dissolved in a mixture of acetic acid and pyridine (1/4, v/v), the mixture was cooled to 0 °C and hydrazine monohydrate (5.0 eq) was added to the solution. The reaction was allowed to stir for 20 min at room temperature. Then the mixture was diluted with EtOAc, washed with 1 N aq. HCl, sat. aq.  $NaHCO_3$  and sat. aq. NaCl. The organic phase was dried over  $Na_2SO_4$  and concentrated *in vacuo*. Purification by column chromatography yielded the product.

## Chapter 7

---

### General procedure for introduction of the BOM group

The alcohol (0.046 mmol) was dissolved in dry DCM (1 ml), DIPEA (300  $\mu$ l, 1.72 mmol), BOMCl (267  $\mu$ l, 1.03 mmol) and TBAI (6.7 mg) was added to the reaction mixture at 0 °C subsequently. The reaction mixture was allowed to stir at room temperature for 1-3 d and monitored by TLC analysis. The reaction mixture was diluted with EtOAc and washed with 1 M HCl, sat. aq. NaHCO<sub>3</sub> and brine and then dried over Na<sub>2</sub>SO<sub>4</sub> and concentrated *in vacuo*. The product was purified by column chromatography (pentane/DCM/acetone, 10:1:1→3:1:1). product was obtained in good yield.

### General procedure for deprotection of the di-*tert*-butyl silylidene ketal

A solution of HF/Pyridine solution (0.5 mmol, 5.0 eq) was added to a solution of starting material in a mixture of THF and pyridine ( 1/1 v/v, 2 ml) at 0 °C. The reaction was allowed to stir overnight at room temperature. Sat. aq. NaHCO<sub>3</sub> was added to neutralize the mixture, which was then diluted with EtOAc and washed with sat. aq. NaCl. The organic phase was dried over MgSO<sub>4</sub> and concentrated *in vacuo*. Purification by column chromatography yielded the deprotected product.

### General procedure of glycosylation reactions toward long oligosaccharides (hexasaccharide, nonasaccharide and dodecasaccharide)

Trisaccharide Imidate donor **13** (2.0 - 3.0 eq) and acceptor **41**, **46** or **48** (1.0 eq) were co-evaporated with toluene (three times). The residue was dissolved in dry DCM (0.05 M acceptor in DCM). The solution was cooled to 0 °C and followed by adding TBSOTf (0.1-0.2 eq) and the reaction was allowed to stir for 3-6 h at 0 °C. The reaction was quenched with Et<sub>3</sub>N (0.4 eq), diluted with DCM, washed with sat. aq. NaCl and the organic phase was dried over Na<sub>2</sub>SO<sub>4</sub> and concentrated *in vacuo*. Purification by column chromatography yielded the products in 72-83% yield.

### General oxidation procedure A: TEMPO/BAIB oxidation and benzyl ester formation

The starting material was dissolved in DCM/*tert*-BuOH/H<sub>2</sub>O (4/4/1,v/v/v). The mixture was cooled to 0°C and TEMPO (0.2 eq) and BAIB (2.5 eq) were added. After stirring the mixture overnight at 4 °C, Na<sub>2</sub>S<sub>2</sub>O<sub>3</sub> was added and the heterogeneous mixture was stirred for 30 minutes, diluted with EtOAc and washed with sat. aq. NaCl. The organic phase was dried over Na<sub>2</sub>SO<sub>4</sub> and concentrated *in vacuo*. The crude residue was dissolved in DMF, followed by the addition of Cs<sub>2</sub>CO<sub>3</sub> (1.0 eq) and BnBr (> 2.0 eq) at 0 °C. The mixture was allowed to stir overnight at room temperature and was then diluted with EtOAc and washed with sat. aq. NaCl. The organic phase was dried over Na<sub>2</sub>SO<sub>4</sub> and concentrated *in vacuo*. Purification by column chromatography (silica gel, pentane/EtOAc, v/v) yielded the benzyl ester product.

### General oxidation procedure B: TEMPO/BAIB-Pinnick oxidation

To a stirred solution of the carbohydrate (0.02 mmol, 1.0 eq.) in THF/CH<sub>2</sub>Cl<sub>2</sub> (2:1 v/v, 0.6 mL) was added, at 0 °C, TEMPO (2.5 mg, 0.016 mmol, 0.8 eq/per one primary alcohol) and PhI(OAc)<sub>2</sub> (13 mg, 0.04 mmol, 2.0 eq/per one

primary alcohol) and the reaction mixture was allowed to warm to room temperature. After 2 d, *tert*-butanol (0.5 mL) and *iso*-amylene (0.05 mL) were added and the reaction mixture was cooled to 0 °C. A solution of NaClO<sub>2</sub> (3.6 mg, 0.04 mmol, 2.0 eq/per one primary alcohol.) and NaH<sub>2</sub>PO<sub>4</sub> (4.8 mg, 0.04 mmol, 2.0 eq/per one primary alcohol.) in water (0.1 mL) was slowly added and the reaction mixture was allowed to stir for 1 hour at 0 °C to room temperature. The reaction was quenched by addition of sat. aq. Na<sub>2</sub>S<sub>2</sub>O<sub>3</sub>, and the mixture diluted with EtOAc, and NaH<sub>2</sub>PO<sub>4</sub> (sat. aq., 0.5 mL) and brine (1 mL) were subsequently added. The layers were separated, and the aqueous phase was extracted with EtOAc. The combined organic phases were dried over MgSO<sub>4</sub>, filtered and concentrated *in vacuo*. Column chromatography (generally, CH<sub>2</sub>Cl<sub>2</sub>/MeOH/AcOH, 200:1:0 → 200:10:1) furnished the corresponding uronic acid or used for next step benzylation without purification.

### General oxidation procedure C: TEMPO/BAIB with NaHCO<sub>3</sub> oxidation

To a stirred solution of the carbohydrate (0.02 mmol, 1.0 eq.) in EtOAc/*t*BuOH/H<sub>2</sub>O (1:1:1, v/v/v, 0.6 mL), TEMPO (2.5 mg, 0.016 mmol, 0.8 eq/per one primary alcohol) and NaHCO<sub>3</sub> (8.4 mg, 0.1 mmol, 5 eq/per one primary alcohol) was added at 0 °C, after 10 min, PhI(OAc)<sub>2</sub> (26 mg, 0.08 mmol, 4.0 eq/per one primary alcohol) was added and the reaction mixture was allowed to stir 2-5 d at 4 °C. The reaction was quenched by addition of sat. aq. Na<sub>2</sub>S<sub>2</sub>O<sub>3</sub>, and the mixture diluted with EtOAc, and NaH<sub>2</sub>PO<sub>4</sub> (sat. aq., 0.5 mL) and brine (1 mL) were subsequently added. The layers were separated, and the aqueous phase was extracted with EtOAc. The combined organic phases were dried over MgSO<sub>4</sub>, filtered and concentrated *in vacuo*. Column chromatography (generally, CH<sub>2</sub>Cl<sub>2</sub>/MeOH/AcOH, 200:1:0 → 200:10:1) furnished the corresponding uronic acid or used for next step benzylation without purification.

### General procedure for transferred azide into acetylamino reactions for long oligosaccharides (hexasaccharide, nonasaccharide and dodecasaccharide)

The oligosaccharide containing azide **51**, **52**, **53** or **1,1-di-trimer-di-azide** (1.0 eq) was dissolved in THF (0.005 M in THF). Pyridine (15 eq/one azide), H<sub>2</sub>O (15 eq/one azide) and Ph<sub>3</sub>P (4 eq/one azide, partially, three times and 1 h in between) were added to reaction mixture and the reaction was allowed to stir for 7 h at 70 °C. The reaction mixture was concentrated *in vacuo*. The residue was dissolved in pyridine (1 mL), Ac<sub>2</sub>O (0.5 mL) was added at 0 °C and stirred for overnight. The reaction mixture was diluted with EtOAc and washed with sat. aq., NaHCO<sub>3</sub> and brine then dried over Na<sub>2</sub>SO<sub>4</sub>, filtered and concentrated *in vacuo*. Column chromatography (generally, CH<sub>2</sub>Cl<sub>2</sub>/MeOH, 200:1 → 60:1) and then run size exclusion (HW-20) to obtain pure product in good yield (88-99%).

### General procedure for fully deprotection (saponification and Birch reduction)

The compound **5**, **6**, **7**, **8** or **1,1-ditrimer-di-COOH** (7-20 mg) was dissolved in THF (2 mL) and MeOH (0.75 mL), 1 M NaOH (0.8 mL) was added to reaction mixture at 0 °C. The mixture was allowed to stir 48 h at room temperature, and then neutralized by H<sub>2</sub>SO<sub>4</sub> (1 M). Diluted with EtOAc and the water layer was extracted with EtOAc (2x20 mL). The combined organic layers was washed with brine then dried over Na<sub>2</sub>SO<sub>4</sub> and concentrated *in vacuo*. The

## Chapter 7

residue was co-evaporated with toluene (three times) for the next step. Ammonia (10 ml) was condensed at  $-70\text{ }^{\circ}\text{C}$ , the residue was dissolved in THF (2 ml) and tert-butanol (0.8 ml) and slowly added to reaction flask containing ammonia. Additive (Allylcarbinol or  $\text{CH}_2=\text{CHCH}_2\text{CH}_2\text{O}-\text{PEG}_4-\text{OCH}_2\text{CH}_2\text{CH}=\text{CH}_2$ , 50  $\mu\text{l}$ ) was added to the reaction mixture. Small pieces sodium added to the reaction mixture one by one to keep deep blue for 15 min. Then ammonia acetate (100 mg) was added to reaction mixture. The solution was allowed to come to room temperature and stirred until all of ammonia was evaporated. Then the solution was concentrated in vacuo and purification by gel filtration (HW-40, 0.15M  $\text{NH}_4\text{OAc}$  in  $\text{H}_2\text{O}$ ). The product containing fractions were pooled and lyophilized (4x) to yield the final products as a white solid. The products were transformed into the sodium salts by passing an aqueous solution of the compounds over a short Dowex  $\text{Na}^+$  column, after which the compounds were lyophilized and obtained **1**, **2**, **3**, **4** or **1,1-di-trimer**.

### Scheme 6. Synthesis of 19a and 19b

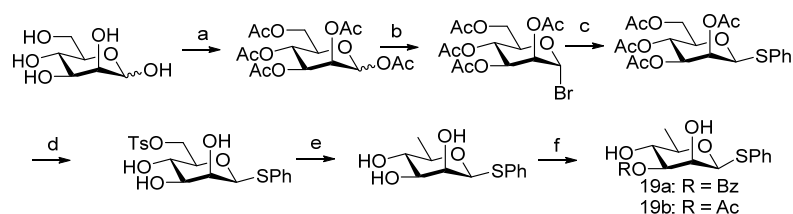

*Reagents and conditions:* (a)  $\text{Ac}_2\text{O}$ , catalytic amount  $\text{H}_2\text{SO}_4$ ,  $0\text{ }^{\circ}\text{C}$  to rt. (b)  $\text{HBr}/\text{AcOH}$ ,  $\text{AcOH}$ . (c)  $\text{PhSH}$ ,  $\text{NaH}$ , three steps yield: 79%. (d) i.  $\text{NaOMe}$ ,  $\text{MeOH}$ ; ii.  $\text{TsCl}$ , pyridine. (e)  $\text{LiAlH}_4$ ,  $\text{THF}$ , three steps yield: 53%. (f)  $\text{BzCl}$  or  $\text{AcCl}$ , dichloro-dimethyl selenium,  $\text{DIPEA}$ ,  $\text{DCM}$ , 19a yield:81%, 19b yield: 90%.

**Phenyl 2,3,4,6-tetra-O-acetyl-1-thio- $\beta$ -D-mannopyranoside**, D-mannose (54 g, 0.3 mol) was added to  $\text{Ac}_2\text{O}$  (170.4 ml, 1.8 mol), then  $\text{H}_2\text{SO}_4$  (two drops, do not add too much because the reaction is going

too fast) was added to the reaction mixture at  $0\text{ }^{\circ}\text{C}$ . The reaction mixture was allowed to stir for 2 h at  $0\text{ }^{\circ}\text{C}$  and the reaction mixture was clear solution. The reaction mixture was allowed to stir at room temperature and monitored by TLC analysis. Then do next step without any work up:  $\text{HBr}/\text{AcOH}$  (33%, w/w, 150 ml) was slowly added to the previous reaction mixture at  $0\text{ }^{\circ}\text{C}$ , and then stir at room temperature for 3 h. The reaction mixture was poured into ice-water. The crude bromide was extracted using  $\text{EtOAc}$  (3 x 400 ml) and the combined organic fractions were washed with sat. aq.  $\text{NaHCO}_3$ , dried over  $\text{Na}_2\text{SO}_4$  and concentrated in vacuo. A solution of glycosidic bromide and  $\text{PhSH}$  (30.8 ml, 0.3 mol) in  $\text{DMF}$  (600 ml) was cooled to  $0\text{ }^{\circ}\text{C}$  and  $\text{NaH}$  (60% dispersion in mineral oil, 12 g, 0.3 mol) was added. The mixture was stirred until full consumption of the bromide and subsequently quenched by the addition of aq.  $\text{HCl}$  (1 M). The product was extracted with  $\text{EtOAc}$  and the combined organic layers was washed with brine then dried over  $\text{Na}_2\text{SO}_4$  and concentrated in vacuo. The product was purified by column chromatography (96 g, three steps yield: 73%). The analytical data were in full accord with

reported previously.<sup>[10]</sup>

**Phenyl 6-deoxy-1-thio-β-D-mannopyranoside: Phenyl 2,3,4,6-tetra-acetyl-1-thio-β-D-mannopyranoside** (69.5 g, 157.8

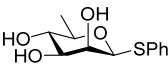
 mmol) was dissolved in MeOH (600 ml), NaOMe in MeOH solution (1 ml) was added to reaction mixture at 0 °C and then the reaction was allowed to stir at room temperature for 4 h. After adding AcOH (2 ml) and toluene (100 ml), the reaction mixture was concentrated in vacuo. The residue was dissolved in pyridine (350 ml), and TsCl (39.1 g, 205.4 mmol) in pyridine (250 ml) was slowly added to reaction mixture at 0 °C. Then the reaction was allowed to stir for overnight at room temperature. The reaction was quenched with MeOH (3 ml), and then concentrated in vacuo. The residue was dissolved in EtOAc (400 ml), washed with H<sub>2</sub>O (100 ml) and brine, the water layer was extracted again with EtOAc (200 ml). The combined organic layers were dried over Na<sub>2</sub>SO<sub>4</sub> and concentrated in vacuo. The residue was dissolved in dry THF (800 ml) and cooled down to 0 °C. LiAlH<sub>4</sub> in THF (2.3 M solution 206 ml, should be very careful for this step) was slowly added to reaction mixture at 0 °C (2-4 h) and then stirred at room temperature for 1 h, then reflux for 6 h. The reaction was quenched by slowly adding EtOAc at 0 °C. And then more EtOAc and 3 M HCl solution was added. The water layer was extracted again with EtOAc (2x500 ml). The combined organic layers were washed with brine then dried over Na<sub>2</sub>SO<sub>4</sub> and concentrated in vacuo. The product was purified by column chromatography (DCM/acetone, 50:1→20:1→2:1, 96 g, three steps yield: 53%). The analytical data were in full accord with reported previously.<sup>[10]</sup>

**Phenyl 3-O-Bz-6-deoxy-1-thio-β-D-mannopyranoside (19a):** Phenyl 6-deoxy-1-thio-β-D-mannopyranoside (3.5 g,

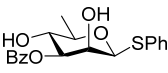
 13.65 mmol) was dissolved in dry THF (70 ml), DIPEA (4.73 ml) and Me<sub>2</sub>SnCl<sub>2</sub> (148 mg) was added to the reaction mixture at 0 °C and stirred for 20 min. Then BzCl (1.75 ml) was added to the reaction mixture. The reaction was allowed to stir for 1 h at room temperature. The reaction mixture was diluted with EtOAc and washed with H<sub>2</sub>O, sat. aq. NaHCO<sub>3</sub> and brine and then dried over Na<sub>2</sub>SO<sub>4</sub> and concentrated in vacuo. The product was purified by column chromatography (DCM/acetone, 10:1→4:1, product 4 g, yield: 81%). The analytical data were in full accord with reported previously.<sup>[10]</sup>

**Phenyl 3-O-Ac-6-deoxy-1-thio-β-D-mannopyranoside (19b):** Phenyl 6-deoxy-1-thio-β-D-mannopyranoside (3.95 g,

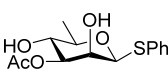
 15.41 mmol) was dissolved in dry THF (70 ml), DIPEA (5.5 ml) and Me<sub>2</sub>SnCl<sub>2</sub> (175 mg) was added to the reaction mixture at 0 °C and stirred for 20 min. Then AcCl (1.75 ml) was added to the reaction mixture. The reaction was allowed to stir for 2 h at room temperature. The reaction mixture was diluted with EtOAc and washed with H<sub>2</sub>O, sat. aq. NaHCO<sub>3</sub> and brine and then dried over Na<sub>2</sub>SO<sub>4</sub> and concentrated in vacuo. The product was purified by column chromatography (DCM/acetone, 10:1→4:1, product 4.12 g, yield: 90%). The analytical data were in full accord with reported previously.<sup>[10]</sup>

## Chapter 7

**Phenyl 2-N<sub>3</sub>-3-O-Bz-4-N-Phth-6-deoxy-1-thio-β-D-galactopyranoside (22a):** The compound **19a** (2.2 g, 6.11 mmol)

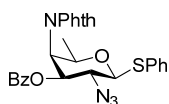

was dissolved in DCM (60 ml) with pyridine (5 ml), Tf<sub>2</sub>O (5 ml) was added to the reaction mixture at -10 °C, and slowly warm up to 10 °C in 2 h. The reaction mixture was diluted with DCM and washed with water and sat. aq. NaHCO<sub>3</sub> and then dried over Na<sub>2</sub>SO<sub>4</sub> and concentrated in vacuo. The residue was dissolved in dry CH<sub>3</sub>CN (105 ml), TBAN<sub>3</sub> (1.65 g, 5.81 mmol) solution in CH<sub>3</sub>CN (15 ml) was slowly added to the reaction mixture at -30 °C. The reaction was allowed to stir for 2 d at same temperature and then concentrated in vacuo. The residue was dissolved in DMF (60 ml), and then PhthK (2 g) was added to the reaction mixture and stirred for overnight at room temperature. The reaction mixture was diluted with EtOAc and washed with water and brine and then dried over Na<sub>2</sub>SO<sub>4</sub> and concentrated in vacuo. The product was purified by column chromatography (Pentane/EtOAc, 8:1, product 1.51 g, yield: 48%). The analytical data were in full accord with reported previously.<sup>[10]</sup>

**Phenyl 2-N<sub>3</sub>-3-O-Ac-4-N-Phth-6-deoxy-1-thio-β-D-galactopyranoside (22b):** The compound **19b** (1.43 g, 4.8 mmol)

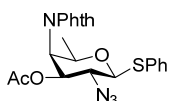

was dissolved in DCM (42 ml) with pyridine (5.16 ml), Tf<sub>2</sub>O (5.04 ml) was added to the reaction mixture at -10 °C, and slowly warm up to 10 °C in 2 h. The reaction mixture was diluted with DCM and washed with water and sat. aq. NaHCO<sub>3</sub> and then dried over Na<sub>2</sub>SO<sub>4</sub> and concentrated in vacuo. The residue was dissolved in dry CH<sub>3</sub>CN (20 ml), TBAN<sub>3</sub> (1.56 g, 5.48 mmol) solution in CH<sub>3</sub>CN (4 ml) was slowly added to the reaction mixture at -20 °C. The reaction was allowed to stir for overnight at same temperature and then concentrated in vacuo. The residue was dissolved in DMF (24 ml), and then PhthK (1.8 g) was added to the reaction mixture and stirred for overnight at room temperature. The reaction mixture was diluted with EtOAc and washed with water and brine and then dried over Na<sub>2</sub>SO<sub>4</sub> and concentrated in vacuo. The product was purified by column chromatography (Pentane/EtOAc, 8:1, product 896 mg, yield: 41%). The analytical data were in full accord with reported previously. <sup>1</sup>H NMR (400 MHz, Chloroform-*d*) δ 7.95 – 7.85 (m, 2H), 7.79 (dd, *J* = 5.6, 3.0 Hz, 2H), 7.68 – 7.51 (m, 2H), 7.41 – 7.28 (m, 3H), 5.19 (ddd, *J* = 8.2, 6.8, 1.4 Hz, 1H, H-3), 4.87 (dd, *J* = 6.8, 2.8 Hz, 1H, H-4), 4.73 – 4.57 (m, 2H, H-1, H-2), 3.95 (qd, *J* = 6.4, 2.8 Hz, 1H, H-5), 1.94 (s, 3H), 1.17 (d, *J* = 6.4 Hz, 3H, H-6). <sup>13</sup>C NMR (101 MHz, CDCl<sub>3</sub>) δ 169.5, 133.4, 132.3, 129.0, 127.9, 123.7, 88.57 (C-1), 73.2 (C-5), 72.4 (C-3), 61.5 (C-2), 51.5 (C-4), 2056, 16.9. IR (neat): 691, 719, 746, 870, 893, 984, 1025, 1048, 1087, 1103, 1159, 1232, 1350, 1355, 1374, 1387, 1440, 1456, 1481, 1507, 1576, 1653, 1684, 1695, 1715, 1730, 2113, 3735. HR-MS: [M+Na<sup>+</sup>] Calculated for C<sub>22</sub>H<sub>20</sub>N<sub>4</sub>O<sub>5</sub>S: 475.1047; found: 475.1056.

**Phenyl 2-N<sub>3</sub>-4-N-Cbz-6-deoxy-1-thio-β-D-galactopyranoside (23):** The compound **22b** (1.22 g, 2.7 mmol) was

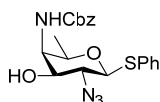

dissolved in butanol (20 ml) with ethylenediamine (5 ml), the reaction mixture was refluxed for 24 h. The reaction mixture concentrated in vacuo. The residue was dissolved in THF (10 ml) and water (5 ml), NaHCO<sub>3</sub> (1.8 g, 21.6 mmol) was added to the reaction mixture at 0 °C. Then CbzCl (1.54 ml, 10.8 mmol) was added into the reaction mixture. The reaction was allowed to stir for 4 h at

same temperature and then diluted with EtOAc and washed brine and then dried over  $\text{Na}_2\text{SO}_4$  and concentrated in vacuo. The product was purified by column chromatography (Pentane/EtOAc, 3:1, product 662 mg, two steps yield: 59%).  $R_f = 0.31$  (pentane/EtOAc, 2:1).  $^1\text{H NMR}$  (400 MHz, Chloroform- $d$ )  $\delta$  7.55 (dd,  $J = 7.6, 2.0$  Hz, 2H), 7.48 – 7.25 (m, 8H), 5.20 – 5.03 (m, 2H,  $\text{CH}_2\text{-Cbz}$ ), 4.96 (d,  $J = 9.1$  Hz, 1H, N-H), 4.39 (d,  $J = 10.2$  Hz, 1H, H-1), 3.97 (m, 1H, H-4), 3.80 – 3.58 (m, 2H, H-3, H-5), 3.39 (d,  $J = 4.2$  Hz, 1H, -OH), 3.20 (t,  $J = 9.9$  Hz, 1H, H-2), 1.25 (d,  $J = 6.5$  Hz, 3H, H-6).  $^{13}\text{C NMR}$  (101 MHz,  $\text{CDCl}_3$ )  $\delta$  158.2, 136.0, 133.6, 131.6, 129.2, 128.7, 128.5, 128.2, 86.7 (C-1), 74.8 (C-3), 73.9 (C-5), 67.7 (Bn), 63.1 (C-2), 55.1 (C-4), 17.2 (C-6).  $[\alpha]_{\text{D}}^{20} = -20^\circ$  ( $c = 1.0$ ,  $\text{CHCl}_3$ ). IR (neat): 625, 668, 698, 748, 1000, 1043, 1218, 1328, 1458, 1507, 1521, 1695, 1717, 2113. HR-MS:  $[\text{M}+\text{Na}^+]$  Calculated for  $\text{C}_{20}\text{H}_{22}\text{N}_4\text{O}_4\text{S}$ : 437.1254; found: 437.1265.

**Phenyl 2- $\text{N}_3$ -3-levulinoyl-4- $\text{N}$ -Cbz-6-deoxy-1-thio- $\beta$ -D-galactopyranoside (24):** The compound **23** (863 mg, 2.081

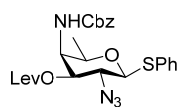

mmol) was dissolved in DCM (4.6 ml) with LevOH (363 mg, 3.2 mmol) and DMAP (351 mg, 3.2 mmol), then EDCI (799 mg, 4.16 mmol) and DIPEA (545  $\mu\text{l}$ ) were added to the reaction mixture at  $0^\circ\text{C}$ . The reaction mixture was stirred for overnight at room temperature. The

reaction mixture was diluted with EtOAc and washed with 1M HCl, sat. aq.  $\text{NaHCO}_3$  and brine and then dried over  $\text{Na}_2\text{SO}_4$  and concentrated in vacuo. The product was purified by column chromatography (Pentane/DCM/EtOAc, 4:1:1, product 1.021 g, yield: 96%).  $R_f = 0.52$  (toluene/EtOAc, 7:3).  $^1\text{H NMR}$  (400 MHz, Chloroform- $d$ )  $\delta$  7.55 (dd,  $J = 7.5, 2.1$  Hz, 2H), 7.42 – 7.30 (m, 8H), 5.14 – 5.01 (dd,  $J = 18.4$  Hz,  $J = 6.0$  Hz, 2H,  $\text{CH}_2\text{-Cbz}$ ), 4.97 (d,  $J = 9.7$  Hz, 1H, N-H), 4.78 (dd,  $J = 10.2, 3.8$  Hz, 1H, H-3), 4.45 (d,  $J = 10.2$  Hz, 1H, H-1), 4.12 (m, 1H, H-4), 3.72 (qd,  $J = 6.3, 1.4$  Hz, 1H, H-5), 3.49 – 3.23 (m, 1H, H-2), 2.74 (m, 1H), 2.69 – 2.49 (m, 2H), 2.48 – 2.32 (m, 1H), 2.12 (s, 3H), 1.22 (d,  $J = 6.4$  Hz, 3H, H-6).  $^{13}\text{C NMR}$  (101 MHz,  $\text{CDCl}_3$ )  $\delta$  206.3, 171.8, 156.4, 136.3, 133.3, 131.3, 129.1, 128.6, 128.5, 128.1, 127.8, 86.5 (C-1), 74.9 (C-3), 73.5 (C-5), 66.9 (Bn), 59.7 (C-2), 51.9 (C-4), 37.8, 27.8, 16.8 (C-6).  $[\alpha]_{\text{D}}^{20} = -24^\circ$  ( $c = 0.25$ ,  $\text{CHCl}_3$ ). IR (neat): 742, 1045, 1066, 1151, 1205, 1216, 1228, 1507, 1700, 1704, 1710, 2114. HR-MS:  $[\text{M}+\text{Na}^+]$  Calculated for 535.1622; found: 535.1627.

**2- $\text{N}_3$ -3- $\text{O}$ -levulinoyl-4- $\text{N}$ -Cbz-6-deoxy-1- $\alpha/\beta$ -D-galactopyranoside (25):** The title compound was obtained as

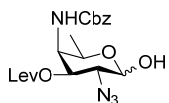

described in the general procedure for hydrolysis of thioglycosidic bond from compound 24.

1.18 g, quantitative yield.  $R_f = 0.2$  (pentane/EtOAc, 3:2).  $^1\text{H NMR}$  (400 MHz, Chloroform- $d$ )  $\delta$  7.42 – 7.28 (m, 5H), 5.89 (d,  $J = 10.3$  Hz, 0.17H, -NH), 5.55 (d,  $J = 9.9$  Hz, 0.83H, -NH), 5.28 (d,  $J = 3.7$  Hz, 0.83H,  $\alpha\text{H-1}$ ), 5.25 (d,  $J = 3.8$  Hz, 0.17H), 5.19 (d,  $J = 9.6$  Hz), 5.18 – 5.02 (m), 4.71 (dd,  $J = 10.8, 4.0$  Hz), 4.67 (dd,  $J = 10.9, 4.0$  Hz), 4.59 (d,  $J = 8.0$  Hz), 4.48 (tt,  $J = 7.6, 3.7$  Hz), 4.21 (ddd,  $J = 9.7, 3.9, 1.7$  Hz), 4.11 (ddd,  $J = 9.9, 4.1, 1.5$  Hz), 4.08 – 4.01 (m), 3.80 – 3.66 (m), 3.60 (dd,  $J = 10.9, 7.9$  Hz), 3.55 – 3.42 (m), 3.38 (d,  $J = 9.7$  Hz), 2.87 – 2.32 (m, 4H), 2.16 (d,  $J = 1.1$  Hz, 3H), 1.22 (d,  $J = 6.4$  Hz), 1.16 (d,  $J = 6.5$  Hz).  $^{13}\text{C NMR}$  (101 MHz,  $\text{CDCl}_3$ )  $\delta$  207.1, 172.2, 157.0, 136.5, 128.7, 128.4, 128.0, 96.5 (C-1 $\beta$ ), 92.1 (C-1 $\alpha$ ), 73.3 (C-3 $\beta$ ), 70.6 (C-3 $\alpha$ ), 69.6 (C-5 $\beta$ ), 67.5, 67.2, 64.5 (C-5 $\alpha$ ), 62.3 (C-2 $\beta$ ), 58.4 (C-2 $\alpha$ ), 52.9 (C-4 $\alpha$ ), 52.1 (C-4 $\beta$ ), 38.0, 29.9, 29.7, 28.0, 16.7 (C-6).  $[\alpha]_{\text{D}}^{20} = 153^\circ$

## Chapter 7

( $c = 0.1$ ,  $\text{CHCl}_3$ ). IR (neat): 697, 741, 1030, 1083, 1154, 1232, 1264, 1327, 1363, 1524, 1695, 1713, 2110. HR-MS:  $[\text{M}+\text{Na}^+]$  Calculated for  $\text{C}_{19}\text{H}_{24}\text{N}_4\text{O}_7$ : 443.1537; found: 443.1545.

**Phenyl 2-N<sub>3</sub>-3-O-Lev-4-N-Cbz-6-deoxy-1-thio-β-D-galactopyranoside (26):** The title compound was obtained as

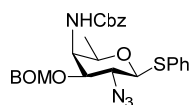

described in the general procedure for BOM protection from compound **23**. 42 mg, yield:

79%.  $R_f = 0.69$  (pentane/EtOAc, 3:1).  $^1\text{H}$  NMR (400 MHz, Chloroform- $d$ )  $\delta$  7.65 – 7.50 (m, 2H), 7.35 (m, 13H), 5.10 (q,  $J = 12.4$  Hz, 2H), 4.99 (d,  $J = 7.5$  Hz, 1H), 4.87 – 4.67 (m, 3H), 4.61 (d,  $J = 11.5$  Hz, 1H), 4.40 (d,  $J = 10.2$  Hz, 1H, H-1), 4.09 (ddd,  $J = 10.2$ , 4.1, 1.3 Hz, 1H, H-4), 3.80 (dd,  $J = 10.0$ , 4.0 Hz, 1H, H-3), 3.63 (qd,  $J = 6.3$ , 1.3 Hz, 1H, H-5), 3.23 (t,  $J = 10.1$  Hz, 1H, H-2), 1.24 (d,  $J = 6.3$  Hz, 3H, H-6).  $^{13}\text{C}$  NMR (101 MHz,  $\text{CDCl}_3$ )  $\delta$  156.8, 137.4, 136.4, 133.8, 131.3, 129.3, 128.8, 128.6, 128.6, 128.4, 128.3, 128.0, 127.9, 92.1 (BOM), 86.5 (C-1), 76.4 (C-3), 74.2 (C-5), 69.9, 67.1, 61.6 (C-2), 51.7 (C-4), 17.2 (C-6).  $[\alpha]_D^{20} = 3^\circ$  ( $c = 0.84$ ,  $\text{CHCl}_3$ ). IR (neat): 694, 739, 976, 1036, 1224, 1457, 1507, 1653, 1715, 2111. HR-MS:  $[\text{M}+\text{Na}^+]$  Calculated for  $\text{C}_{28}\text{H}_{29}\text{N}_4\text{O}_5\text{S}$ : 556.1750; found: 556.2771.

**2-N<sub>3</sub>-3-O-BOM-4-N-Cbz-6-deoxy-1-α/β-D-galactopyranoside (27):** The title compound was obtained as described in

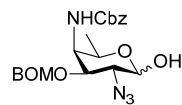

the general procedure for hydrolysis of thioglycosidic bond from compound **26**. 80 mg,

yield: 97%.  $R_f = 0.28$  (pentane/DCM/EtOAc, 2:1:1).  $^1\text{H}$  NMR (400 MHz, Chloroform- $d$ )  $\delta$  7.44 – 7.25 (m, 10H), 5.82 (d,  $J = 10.3$  Hz), 5.53 (d,  $J = 10.2$  Hz), 5.28 – 4.87 (m), 4.89 – 4.54 (m), 4.46 (dd,  $J = 15.5$ , 6.9 Hz), 4.36 – 4.22 (m), 4.20 – 4.10 (m), 4.06 (m), 3.71 (dd,  $J = 10.5$ , 4.2 Hz), 3.64 – 3.43 (m, 1H), 3.43 – 3.29 (m, 1H), 1.19 (d,  $J = 6.3$  Hz), 1.14 (d,  $J = 6.5$  Hz).  $^{13}\text{C}$  NMR (101 MHz,  $\text{CDCl}_3$ )  $\delta$  157.2, 137.5, 136.4, 128.6, 128.6, 128.6, 128.5, 128.4, 128.3, 128.2, 128.1, 128.0, 127.9, 127.9, 96.4 (C-1 $\beta$ ), 92.12, 91.9 (C-1 $\alpha$ ), 74.5 (C-3 $\beta$ ), 71.5 (C-3 $\alpha$ ), 70.1 (C-5 $\beta$ ), 69.9, 69.8, 67.1, 65.0 (C-5 $\alpha$ ), 64.1 (C-2 $\beta$ ), 60.0 (C-2 $\alpha$ ), 52.6 (C-4 $\alpha$ ), 51.8 (C-4 $\beta$ ), 16.8 (C-6).  $[\alpha]_D^{20} = 9^\circ$  ( $c = 0.23$ ,  $\text{CHCl}_3$ ). IR (neat): 698, 748, 1039, 1222, 1457, 1507, 1560, 1700, 1715, 2110. HR-MS:  $[\text{M}+\text{Na}^+]$  Calculated for  $\text{C}_{22}\text{H}_{26}\text{N}_4\text{O}_6$ : 465.1745; found: 465.1738.

**2-N<sub>3</sub>-3-O-levulinoyl -4-N-Cbz-6-deoxy-1-O-(N-phenyl-trifluoroacetimidoyl)-α/β-D-galactopyranoside (15):** The title

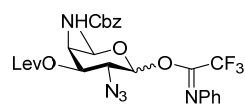

compound was obtained as described in the general procedure for yield  $N$ -phenyl-

trifluoroacetimidate donor from compound **25**.  $^1\text{H}$  NMR (400 MHz, Chloroform- $d$ )  $\delta$  7.42 – 7.28 (m, 7H), 7.22 – 7.05 (m, 1H), 6.92 – 6.74 (m, 2H), 5.43 (d,  $J = 75.1$  Hz, 1H, H-1), 5.17 (d,  $J = 12.2$  Hz, 1H), 5.13 – 5.00 (m, 2H), 4.76 (s, 1H, H-3), 4.40 – 4.25 (m, 0H), 4.15 (dt,  $J = 7.1$ , 3.6 Hz, 1H, H-4), 3.74 (m, 2H, H-2, H-5), 2.89 – 2.72 (m, 1H), 2.72 – 2.52 (m, 2H), 2.52 – 2.33 (m, 1H), 2.17 (s, 3H), 1.31 – 1.12 (m, 3H).  $^{13}\text{C}$  NMR (101 MHz,  $\text{CDCl}_3$ )  $\delta$  206.4, 172.0, 156.6, 143.0, 136.3, 128.9, 128.7, 128.5, 128.2, 124.8, 119.3, 95.8 (C-1), 73.3 (C-3), 70.8 (C-5), 67.3, 60.19 (C-2), 51.9 (C-4), 37.9, 29.9, 27.9, 16.5 (C-6). HR-MS:  $[\text{M}+\text{Na}^+]$  Calculated for  $\text{C}_{27}\text{H}_{28}\text{F}_3\text{N}_5\text{O}_7$ : 614.1833; found: 614.1841.



**2-N<sub>3</sub>-3-O-BOM-4-N-Cbz-6-deoxy-1-O** *-(N-phenyl-trifluoroacetimidoyl)-α/β-D-galactopyranoside (16)*: The title

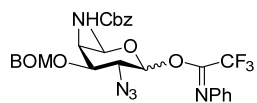

compound was obtained as described in the general procedure for yield *N*-phenyl-

trifluoroacetimidate donor from compound **27**. <sup>1</sup>H NMR (400 MHz, Chloroform-*d*)

δ 7.64 – 7.47 (m, 0.6H), 7.47 – 7.21 (m, 13H), 7.16 – 7.05 (m, 1H), 6.91 – 6.75 (m,

2H), 6.36 (s, 0.13H), 5.39 (d, *J* = 66.2 Hz, 1H), 5.05 (d, *J* = 61.5 Hz, 5H), 4.87 – 4.69 (m, 2H), 4.62 (d, *J* = 11.6 Hz, 1H),

4.51 – 4.37 (m, 0.35H), 4.35 – 4.16 (m, 0.65H), 4.16 – 4.02 (m, 1H), 3.79 (bs, 1H), 3.60 (bs, 2H), 1.32 – 1.18 (m, 3H).

<sup>13</sup>C NMR (101 MHz, CDCl<sub>3</sub>) δ 156.9, 143.2, 137.4, 136.3, 129.4, 128.9, 128.7, 128.6, 128.3, 128.1, 128.0, 126.4,

124.7, 120.7, 119.30, 95.9 (C-1), 92.2, 74.6 (C-3), 71.5, 71.2 (C-5), 69.9, 68.2, 67.3, 62.1 (C-2), 58.9, 52.1 (C-4), 46.2,

16.6 (C-6). HR-MS: [M-OC(CF<sub>3</sub>)=NPh+H<sub>2</sub>O+Na<sup>+</sup>] Calculated for C<sub>22</sub>H<sub>26</sub>N<sub>4</sub>O<sub>6</sub>: 465.1745; found: 465.1752.

**Phenyl 2,3,4,6-tetra-O-acetyl-1-thio-β-D-galactopyranoside (28)**, D-galactose (90 g, 0.5 mol) was added to Ac<sub>2</sub>O

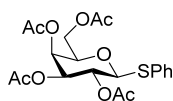

(284 ml, 3 mol), then H<sub>2</sub>SO<sub>4</sub> (three drops, can not add too much in case the reaction is

going too fast) was added to the reaction mixture at 0 °C. The reaction mixture was

allowed to stir for 2 h at 0 °C and the reaction mixture was clear solution. The reaction

mixture was allowed to stir at room temperature and monitored by TLC analysis. The reaction mixture was poured

into ice-water. The product was extracted using EtOAc (3 x 400 ml) and the combined organic fractions were

washed with sat. aq. NaHCO<sub>3</sub>, dried over Na<sub>2</sub>SO<sub>4</sub> and concentrated in vacuo. A solution of penta-O-acetyl-D-

galactopyranoside and PhSH 90.6 ml, 0.9 mol) in DCM (600 ml) was cooled to 0 °C and Et<sub>2</sub>O•BF<sub>3</sub> (48%, w/w, 103.1

ml) was added. The mixture was stirred for 2 days at room temperature. The reaction was quenched by the

addition of Et<sub>3</sub>N and diluted with DCM, washed with 1 M NaOH and brine then dried over Na<sub>2</sub>SO<sub>4</sub> and

concentrated in vacuo. The product was purified by column chromatography (154.6 g, two steps yield: 70%). The

analytical data were in full accord with reported previously.<sup>[19]</sup>

**Phenyl 2,3-di-O-benzyl-1-thio-β-D-galactopyranoside (29)**, Phenyl 2,3,4,6-tetra-O-acetyl-1-thio-β-D-

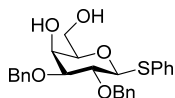

galactopyranoside (33.3 g, 75.75 mmol) was added to MeOH (500 ml), then NaOMe in

MeOH (5 ml) was added to the reaction mixture at 0 °C. The reaction mixture was allowed

to stir for overnight at room temperature and monitored by TLC analysis. The reaction

mixture was neutralized by Amberlite H<sup>+</sup> resin. After filtration. The reaction solution was concentrated in vacuo.

The residue was dissolved in CH<sub>3</sub>CN (434 ml), benzaldehyde dimethyl acetal (17.13 ml) and camphorsulfonic acid

(5.25 g) were added to the reaction mixture at 0 °C. The reaction mixture was allowed to stir for overnight at room

temperature and monitored by TLC analysis. The reaction was quenched by the addition of Et<sub>3</sub>N and diluted with

EtOAc, washed with sat. aq. NaHCO<sub>3</sub> and brine then dried over Na<sub>2</sub>SO<sub>4</sub> and concentrated in vacuo. The residue was

dissolved in DMF (250 ml), NaH (60% in mineral oil, 9 g) was slowly added to the reaction mixture at 0 °C. After 20

min, BnBr (27 ml) was added to the reaction mixture. The reaction mixture was allowed to stir for overnight at

room temperature. The reaction was quenched by the addition of water and diluted with EtOAc, washed with

## Chapter 7

brine then dried over  $\text{Na}_2\text{SO}_4$  and concentrated in vacuo. The residue was dissolved in MeOH (900 ml), DCM (400 ml),  $\text{TsoH}\cdot\text{H}_2\text{O}$  was added to the reaction mixture until  $\text{PH} = 2$ . The reaction mixture was allowed to stir for overnight at room temperature and monitored by TLC analysis. The reaction was quenched by the addition of  $\text{Et}_3\text{N}$  and diluted with EtOAc, washed with brine then dried over  $\text{Na}_2\text{SO}_4$  and concentrated in vacuo. The product was purified by column chromatography (pentane/EtOAc, 6:1→1:1, product 29.5 g, four steps yield: 86%). The analytical data were in full accord with reported previously.<sup>[20]</sup>

**Benzyl phenyl-2,3-di-O-benzyl-1-thio-β-D-galactopyranosyl uronate (30):** Compound **29** (6.17 g, 13.63 mmol) was

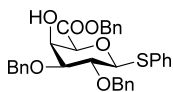

dissolved in DCM/*tert*-BuOH/ $\text{H}_2\text{O}$  (90 ml, 4/4/1, v/v/v). The mixture was cooled to  $0^\circ\text{C}$  and treated with TEMPO (426 mg, 2.73 mmol) and BAIB (11 g, 34.08 mmol). After stirring for overnight at  $4^\circ\text{C}$ ,  $\text{Na}_2\text{S}_2\text{O}_3$  was added, the mixture was diluted with EtOAc, washed with

sat. aq. NaCl and the organic phase was dried over  $\text{Na}_2\text{SO}_4$  and concentrated *in vacuo*. The crude residue was dissolved in DMF (50 ml), followed by addition of  $\text{Cs}_2\text{CO}_3$  (4.44 g, 13.63 mmol) and BnBr (2.41 ml, 20.45 mmol) at  $0^\circ\text{C}$ . The mixture was allowed to stir overnight at room temperature, and then diluted with EtOAc, washed with sat. aq. NaCl. The organic phase was dried over  $\text{Na}_2\text{SO}_4$  and concentrated *in vacuo*. Purification by column chromatography (silica gel, pentane/DCM/EtOAc, 8/1/1, v/v/v) yielded **30** as white solid (5.09 g, two steps yield 67%). TLC:  $R_f = 0.5$  (pentane/EtOAc, 2/1, v/v).<sup>[21]</sup>

**Benzyl phenyl-2,3-di-O-benzyl-4-O-levulinoyl-1-thio-β-D-galactopyranosyl uronate (31):** The compound **30** (9.5 g,

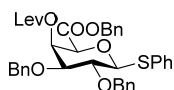

17.07 mmol) was dissolved in DCM (80 ml) with LevOH (3.96 g, 34.14 mmol) and DMAP (4.16 g, 34.14 mmol), then EDCI (6.56 g, 34.14 mmol) and DIPEA (5.95 ml, 34.14 mmol) were added to the reaction mixture at  $0^\circ\text{C}$ . The reaction mixture was stirred for overnight

at room temperature. The reaction mixture was diluted with EtOAc and washed with 1M HCl, sat. aq.  $\text{NaHCO}_3$  and brine and then dried over  $\text{Na}_2\text{SO}_4$  and concentrated *in vacuo*. The product was purified by column chromatography (Pentane/DCM/EtOAc, 6:1:1, product 10.35 g, yield: 93%).  $R_f = 0.7$  (toluene/EtOAc, 3:1).  $^1\text{H}$  NMR (400 MHz, Chloroform-*d*)  $\delta$  7.74 – 7.61 (m, 2H), 7.45 – 7.23 (m, 18H), 5.82 (dd,  $J = 3.1, 1.3$  Hz, 1H, H-4), 5.19 (s, 2H), 4.82 – 4.65 (m, 3H), 4.60 (d,  $J = 9.3$  Hz, 1H, H-1), 4.45 (d,  $J = 11.1$  Hz, 1H), 4.14 (d,  $J = 1.3$  Hz, 1H, H-5), 3.71 – 3.49 (m, 2H, H-3, H-2), 2.69 – 2.41 (m, 4H), 2.12 (s, 3H).  $^{13}\text{C}$  NMR (101 MHz,  $\text{CDCl}_3$ )  $\delta$  206.0, 171.5, 166.3, 138.1, 137.4, 135.1, 133.3, 132.7, 129.0, 128.8, 128.6, 128.6, 128.4, 128.4, 128.2, 128.2, 128.0, 127.9, 87.3 (C-1), 80.5 (C-3), 76.0 (C-2), 75.7, 75.5 (C-5), 71.9, 67.8 (C-4), 67.6, 37.9, 29.8, 27.9.  $[\alpha]_D^{20} = +12^\circ$  (c = 1.0,  $\text{CHCl}_3$ ). IR (neat): 697, 738, 1028, 1104, 1121, 1154, 1202, 1266, 1747. HR-MS:  $[\text{M}+\text{Na}^+]$  Calculated for  $\text{C}_{38}\text{H}_{38}\text{SO}_8$ : 677.2180; found: 677.2187.

**Benzyl 2,3-di-O-benzyl-4-O-levulinoyl-1-α/β-D-galactopyranosyl uronate (32):** The title compound was obtained as

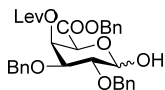

described in the general procedure for hydrolysis of thioglycosidic bond. 8.91 g, yield: 91%.  $R_f = 0.2$  (pentane/DCM/EtOAc, 2:1:1, v/v/v).  $^1\text{H}$  NMR (400 MHz, Chloroform-*d*)  $\delta$  7.44 – 7.18

(m, 15H), 5.87 (dd,  $J = 3.5, 1.7$  Hz, 1H, H-4 $\alpha$ ), 5.78 (dd,  $J = 3.2, 1.4$  Hz, 0.2H), 5.37 (d,  $J = 3.5$  Hz, 1H, H-1 $\alpha$ ), 5.27 – 5.10 (m, 2H), 4.89 (d,  $J = 11.0$  Hz, 0.2H), 4.85 – 4.59 (m, 4H, H-5 $\alpha$ ), 4.50 (t,  $J = 11.3$  Hz, 1H), 4.12 (d,  $J = 1.4$  Hz, 0.2H), 4.00 (dd,  $J = 9.9, 3.5$  Hz, 1H, H-3 $\alpha$ ), 3.76 (dd,  $J = 9.8, 3.6$  Hz, 1H, H-2 $\alpha$ ), 3.63 – 3.42 (m, 0.2H), 2.69 – 2.36 (m, 4H), 2.16 (s, 0H), 2.09 (s, 3H).  $^{13}\text{C}$  NMR (101 MHz,  $\text{CDCl}_3$ )  $\delta$  206.2, 171.6, 167.8, 137.9, 135.1, 129.2, 129.2, 128.7, 128.5, 128.4, 128.4, 128.2, 128.2, 128.1, 128.0, 127.8, 97.4 (C-1 $\beta$ ), 92.2 (C-1 $\alpha$ ), 79.3, 78.7, 75.4 (C-3 $\alpha$ ), 75.3 (C-2 $\alpha$ ), 74.9, 73.8, 72.4, 72.1, 68.9 (C-5 $\alpha$ ), 68.7 (C-4 $\alpha$ ), 67.9, 67.8, 67.7, 38.1, 29.8, 28.0.  $[\alpha]_{\text{D}}^{20} = 40^\circ$  ( $c = 1.0$ ,  $\text{CHCl}_3$ ). IR (neat): 697, 737, 906, 1028, 1100, 1151, 1206, 1361, 1455, 1715, 1739. HR-MS:  $[\text{M}+\text{Na}^+]$  Calculated for  $\text{C}_{32}\text{H}_{34}\text{O}_9$ : 585.2095; found: 585.2104.

**Benzyl 2,3-di-O-benzyl-4-O-levulinoyl-1-O-(*N*-phenyl-trifluoroacetimidoyl)- $\alpha$ - $\beta$ -D-galactopyranosyl uronate (17):** The

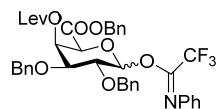

title compound was obtained as described in the general procedure for yield *N*-phenyl-trifluoroacetimidate donor from compound **32**. 1.53 g, yield: 93%.  $R_f = 0.88$  (pentane/DCM/EtOAc, 2:1:1, v/v/v).  $^1\text{H}$  NMR (400 MHz, Chloroform- $d$ )  $\delta$  7.48 – 7.15 (m, 17H), 7.14 – 6.98 (m, 1H), 6.78 (d,  $J = 7.7$  Hz, 2H), 5.80 (bs, 1H, H-4), 5.34 – 5.13 (m, 2H), 4.95 – 4.64 (m, 3H, H-5), 4.50 (d,  $J = 11.3$  Hz, 1H), 3.80 (bs, 1H, H-3), 3.65 (bs, 1H, H-2), 2.74 – 2.40 (m, 4H), 2.14 (s, 3H).  $^{13}\text{C}$  NMR (101 MHz,  $\text{CDCl}_3$ )  $\delta$  206.1, 171.5, 165.8, 137.7, 137.4, 135.0, 129.3, 129.3, 128.8, 128.7, 128.5, 128.5, 128.4, 128.4, 128.2, 128.1, 128.0, 127.9, 127.9, 127.7, 124.4, 119.4, 96.5 (C-1), 78.8 (C-2), 76.9 (C-3), 75.9, 75.1, 74.1, 73.8, 73.1 (C-5), 72.3, 71.2, 68.4, 67.9, 67.5 (C-4), 38.0, 29.9, 29.4, 28.0. HR-MS:  $[\text{M}+\text{Na}^+]$  Calculated for  $\text{C}_{40}\text{H}_{38}\text{F}_3\text{NO}_9$ : 756.2391; found: 756.2405.

**Phenyl 2-O-benzyl-1-thio- $\beta$ -D-galactopyranoside (34):** Compound **28** (27.9 g, 63.34 mmol) was added to MeOH

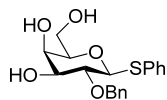

(450 ml), then NaOMe in MeOH (4.5 ml) was added to the reaction mixture at  $0^\circ\text{C}$ . The reaction mixture was allowed to stir for overnight at room temperature and monitored by TLC analysis. The reaction mixture was neutralized by Amberlite  $\text{H}^+$  resin. After filtration.

The reaction solution was concentrated in vacuo. The residue was added in dimethoxypropane (290 ml), and camphorsulfonic acid (724 mg) were added to the reaction mixture at  $0^\circ\text{C}$ . The reaction mixture was allowed to stir for 48 h at room temperature and monitored by TLC analysis. The reaction was quenched by the addition of  $\text{Et}_3\text{N}$  and diluted with EtOAc, washed with sat. aq.  $\text{NaHCO}_3$  and brine then dried over  $\text{Na}_2\text{SO}_4$  and concentrated in vacuo. The residue was dissolved in DMF (200 ml), NaH (60% in mineral oil, 3.8 g, 95 mmol) was slowly added to the reaction mixture at  $0^\circ\text{C}$ . After 20 min, BnBr (11.3 ml) was added to the reaction mixture. The reaction mixture was allowed to stir for overnight at room temperature. The reaction was quenched by the addition of water and diluted with EtOAc, washed with brine then dried over  $\text{Na}_2\text{SO}_4$  and concentrated in vacuo. The residue was dissolved in AcOH/ $\text{H}_2\text{O}$  (80% /20%, v/v). The reaction mixture was allowed to stir for 3 h at  $70^\circ\text{C}$  and monitored by TLC analysis. The reaction mixture concentrated in vacuo. The product was purified by column chromatography (DCM/acetone, 4:1, product 12.9 g, four steps yield: 56%). The analytical data were in full accord with reported

previously.

**Phenyl 2-O-benzyl-4,6-di-*tert*-butylsilylidene-1-thio- $\beta$ -D-galactopyranoside (18):** Compound **34** (12.9 g, 35.59 mmol)

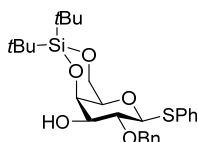

was added to pyridine (200 ml), then di-*tert*-butylsilyl bis(trifluoromethanesulfonate) (12.17 ml, 37.37 mmol) was added to the reaction mixture at  $-30\text{ }^{\circ}\text{C}$ . The reaction mixture was allowed to slowly warm up to room temperature and stir for 4 h. The reaction was quenched by the addition of MeOH and concentrated in vacuo. The residue was diluted with EtOAc, washed with brine then dried over  $\text{Na}_2\text{SO}_4$  and concentrated in vacuo. The product was purified by column chromatography (pentane/EtOAc, 8:1, product 15.95 g, yield: 89%).  $R_f = 0.46$  (pentane/EtOAc, 6:1, v/v).  $^1\text{H}$  NMR (400 MHz, Chloroform- $d$ )  $\delta$  7.63 – 7.11 (m, 10H), 4.93 (bs, 2H), 4.63 (d,  $J = 9.5$  Hz, 1H, H-1), 4.37 (m, 1H, H-4), 4.20 (t,  $J = 1.7$  Hz, 2H, H-6), 3.74 – 3.45 (m, 2H, H-3, H-2), 3.42 – 3.24 (m, 1H, H-5), 2.72 (s, 1H, -OH), 1.16 – 1.09 (m, 9H), 1.06 (s, 9H).  $^{13}\text{C}$  NMR (101 MHz,  $\text{CDCl}_3$ )  $\delta$  138.3, 134.5, 132.3, 128.8, 128.5, 127.9, 127.5, 88.1 (C-1), 79.1 (C-2), 75.7, 75.5 (C-3), 74.8 (C-5), 73.1 (C-4), 67.1 (C-6), 27.7, 20.8.  $[\alpha]_D^{20} = -17^{\circ}$  ( $c = 1.0$ ,  $\text{CHCl}_3$ ). IR (neat): 611, 631, 649, 675, 690, 735, 737, 780, 809, 824, 885, 917, 961, 1048, 1077, 1161, 1471, 2857, 2932. HR-MS:  $[\text{M}+\text{Na}^+]$  Calculated for  $\text{C}_{27}\text{H}_{38}\text{SiO}_5$ : 525.2101; found: 525.2103.

**Phenyl 2-O-benzyl-3-O-(benzyl 2,3-di-O-benzyl-4-O-levulinoyl- $\alpha$ -D-galactopyranosyl urinate)-4,6-di-*tert*-butylsilylidene-1-thio- $\beta$ -D-galactopyranoside (35):** Donor **17** (5.34 g, 7.28 mmol) and acceptor **18** (2.44 g, 4.85 mmol)

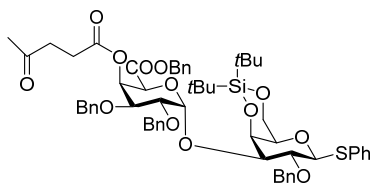

were co-evaporated with toluene (three times). The residue was dissolved in dry DCM (48 ml) and stirred for 30 min with activated 5A molecular sieves at room temperature. The solution was cooled to  $-70\text{ }^{\circ}\text{C}$ , followed by the addition of TfOH (75  $\mu\text{l}$ , 0.49 mmol) and the reaction was allowed to stir for 6 h at  $-70\text{ }^{\circ}\text{C}$ . The reaction was quenched with sat. aq.  $\text{NaHCO}_3$  and diluted with DCM, filtrated and washed with sat. aq.  $\text{NaCl}$ . The organic phase was dried over  $\text{Na}_2\text{SO}_4$  and concentrated in vacuo. Purification by column chromatography yielded the product 3.9 g, yield: 77%.  $R_f = 0.27$  (toluene/EtOAc, 6:1).  $^1\text{H}$  NMR (400 MHz, Chloroform- $d$ )  $\delta$  7.58 – 7.46 (m, 2H), 7.40 – 7.19 (m, 20H), 7.14 (dd,  $J = 5.2, 1.9$  Hz, 3H), 5.57 (dd,  $J = 3.4, 1.7$  Hz, 1H, H-4'), 5.46 (d,  $J = 3.3$  Hz, 1H, H-1'), 5.16 (d,  $J = 11.9$  Hz, 1H), 5.02 (dd,  $J = 11.3, 7.5$  Hz, 2H), 4.79 (d,  $J = 11.7$  Hz, 1H), 4.69 (m, 5H, H-4, H-5', H-1), 4.60 (d,  $J = 11.2$  Hz, 1H), 4.39 (d,  $J = 11.2$  Hz, 1H), 4.18 (qd,  $J = 12.4, 1.8$  Hz, 2H, H-6), 3.98 – 3.78 (m, 3H, H-3', H-3, H-2'), 3.67 (dd,  $J = 9.4, 2.9$  Hz, 1H, H-2), 3.30 (d,  $J = 2.0$  Hz, 1H, H-5), 2.62 – 2.35 (m, 4H), 2.06 (s, 3H), 1.09 (s, 9H), 1.02 (s, 9H).  $^{13}\text{C}$  NMR (101 MHz,  $\text{CDCl}_3$ )  $\delta$  206.0, 171.3, 167.4, 138.2, 138.0, 135.0, 134.7, 129.1, 128.9, 128.5, 128.5, 128.3, 128.2, 127.9, 127.8, 127.6, 127.6, 127.5, 127.4, 93.1 (C-1'), 88.7 (C-1), 77.9 (C-3), 76.5 (C-2'), 75.8, 75.4 (C-3'), 74.6 (C-5), 73.9 (C-2'), 72.3, 72.0, 69.0 (C-5'), 68.6 (C-4'), 68.3 (C-4), 67.6, 67.3 (C-6), 37.9, 29.7, 27.9, 27.7, 23.3, 20.7.  $[\alpha]_D^{20} = +81^{\circ}$  ( $c = 1.0$ ,  $\text{CHCl}_3$ ). IR (neat): 651, 697, 737, 786, 809, 826, 918, 969, 1044, 1080, 1118, 1151, 1211, 1363, 1454, 1718, 1749, 2856, 2934. HR-MS:  $[\text{M}+\text{Na}^+]$  Calculated for  $\text{C}_{59}\text{H}_{70}\text{SiO}_{13}$ : 1069.4199; found: 1069.4232.

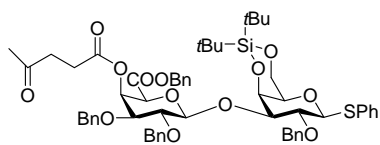

$^1\text{H}$  NMR (400 MHz, Chloroform-*d*)  $\delta$  7.57 – 7.48 (m, 2H), 7.47 – 7.02 (m, 30H), 5.71 (dd,  $J$  = 3.7, 1.4 Hz, 1H), 5.23 – 5.02 (m, 3H), 4.98 (d,  $J$  = 7.9 Hz, 1H), 4.91 – 4.81 (m, 2H), 4.78 – 4.51 (m, 6H), 4.27 – 4.13 (m, 2H), 4.07 – 3.80 (m, 3H), 3.58 (dd,  $J$  = 9.7, 7.8 Hz, 1H), 3.42 (dd,  $J$  = 9.7, 3.6 Hz, 1H), 3.37 (s, 1H), 2.70 – 2.42 (m, 4H), 2.12 (s, 3H), 1.15 (s, 8H), 1.10 (s, 9H).  $^{13}\text{C}$  NMR (101 MHz,  $\text{CDCl}_3$ )  $\delta$  206.3, 171.6, 166.6, 138.6, 138.1, 135.0, 132.0, 129.1, 129.0, 128.7, 128.7, 128.7, 128.6, 128.4, 128.4, 128.3, 128.0, 127.9, 127.8, 127.7, 127.5, 102.6, 89.0, 78.8, 78.1, 75.3, 75.1, 73.2, 72.5, 72.1, 68.1, 67.7, 67.3, 38.1, 30.0, 28.1, 27.8, 23.5, 20.9.

**Phenyl 2-*O*-benzyl-3-*O*-(benzyl 2,3-di-*O*-benzyl- $\alpha$ -D-galactopyranosyl urinate)-4,6-di-*tert*-butylsilylidene-1-thio- $\beta$ -D-galactopyranoside (36):** The title compound was obtained by general procedure for delevalinylation from

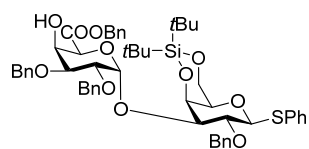

compound **35**. 0.97 g, yield: 89%.  $R_f$  = 0.28 (toluene/EtOAc, 5:1).  $^1\text{H}$  NMR (400 MHz, Chloroform-*d*)  $\delta$  7.52 (dd,  $J$  = 7.8, 1.8 Hz, 2H), 7.40 – 7.21 (m, 20H), 7.21 – 7.09 (m, 3H), 5.50 (d,  $J$  = 3.3 Hz, 1H, H-1'), 5.22 (d,  $J$  = 12.3 Hz, 1H), 5.09 (d,  $J$  = 12.4 Hz, 1H), 5.01 (d,  $J$  = 10.6 Hz, 1H), 4.84 (d,  $J$  = 11.7 Hz, 1H), 4.77 – 4.51 (m, 8H, H-4, H-1, H-5'), 4.26 – 4.13 (m, 2H, H-6), 4.10 (m, 1H, H-4'), 3.98 (dd,  $J$  = 9.7, 3.3 Hz, 1H, H-2'), 3.92 – 3.81 (m, 2H, H-3', H-2), 3.69 (dd,  $J$  = 9.3, 2.9 Hz, 1H, H-3), 3.30 (bs, 1H, H-5), 1.08 (d,  $J$  = 1.1 Hz, 9H), 1.01 (s, 9H).  $^{13}\text{C}$  NMR (101 MHz,  $\text{CDCl}_3$ )  $\delta$  168.5, 138.3, 138.2, 137.9, 135.5, 134.8, 132.1, 128.9, 128.6, 128.5, 128.4, 128.4, 128.3, 128.1, 127.9, 127.8, 127.7, 127.7, 127.7, 127.5, 92.6 (C-1'), 88.8 (C-1), 77.8 (C-3), 76.8 (C-2), 76.6 (C-3'), 75.9, 74.6 (C-5), 74.4 (C-3), 72.9, 72.1, 69.9 (C-5'), 68.5 (C-4), 68.4 (C-4'), 67.4 (C-6), 67.1, 27.8, 27.7, 23.4, 20.8.  $[\alpha]_D^{20}$  = +79° ( $c$  = 1.0,  $\text{CHCl}_3$ ). IR (neat): 650, 695, 734, 789, 809, 825, 949, 967, 1027, 1078, 1154, 1210, 1363, 1761, 2112, 2856. HR-MS:  $[\text{M}+\text{Na}^+]$  Calculated for  $\text{C}_{54}\text{H}_{64}\text{SSiO}_{11}$ : 971.3831; found: 971.3859.

**Phenyl (2-*O*-benzyl-3-*O*-[benzyl 2,3-di-*O*-benzyl-4-*O*-{2-azide-3-*O*-BOM-4-*N*-Cbz-6-deoxy-1- $\alpha$ -D-galactopyranoside]- $\alpha$ -D-galactopyranosyl urinate)-4,6-di-*tert*-butylsilylidene-1-thio- $\beta$ -D-galactopyranoside (37):** Donor **16** (85 mg, 0.139

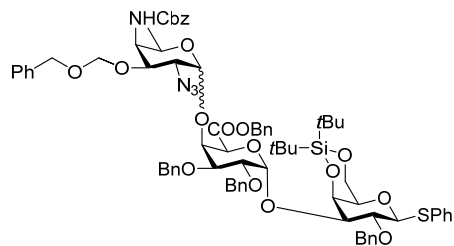

mmol) and acceptor **36** (88.3 g, 0.093 mmol) were co-evaporated with toluene (three times). The residue was dissolved in dry DCM (0.93 ml). The solution was cooled to 0 °C, followed by the addition of TBSOTf (2.1  $\mu\text{l}$ , 9.3  $\mu\text{mol}$ ) and the reaction was allowed to stir for overnight at 0 °C. The reaction was quenched with  $\text{Et}_3\text{N}$  and diluted with DCM, washed with sat. aq. NaCl. The organic phase was dried over  $\text{Na}_2\text{SO}_4$  and concentrated in vacuo. Purification by column chromatography yielded the product ( $\alpha/\beta$  = 2.9:1) 32 mg, yield: 25%. And also found the BOM protecting group was removed byproduct **38** 34 mg, yield: 29%.

## Chapter 7

Data for 37 $\alpha$  product:  $^1\text{H}$  NMR (400 MHz, Chloroform-*d*)  $\delta$  7.58 – 7.47 (m, 2H), 7.45 – 7.08 (m, 33H), 5.52 (d,  $J = 3.5$  Hz, 1H, H-1'), 5.29 (d,  $J = 7.8$  Hz, 1H), 5.25 (s, 1H), 5.14 – 5.05 (m, 2H), 5.04 – 4.86 (m, 4H), 4.82 (d,  $J = 9.9$  Hz, 1H), 4.78 – 4.54 (m, 10H, H-4, H-1, H-1''), 4.49 (s, 1H, H-5'), 4.27 – 4.10 (m, 4H, H-5'', H-4', H-6), 4.09 – 3.92 (m, 3H, H-3'', H-4'', H-2'), 3.83 (m, 2H, H-2, H-3'), 3.69 (dd,  $J = 9.4, 2.8$  Hz, 1H, H-3), 3.27 (d,  $J = 1.9$  Hz, 1H, H-5), 2.96 (dd,  $J = 10.8, 4.0$  Hz, 1H, H-2''), 1.07 (s, 9H), 1.01 (s, 9H), 0.79 (d,  $J = 6.3$  Hz, 3H, H-6'').  $^{13}\text{C}$  NMR (101 MHz,  $\text{CDCl}_3$ )  $\delta$  167.9, 156.9, 138.4, 138.1, 138.0, 137.8, 136.4, 134.9, 134.8, 132.1, 128.9, 128.9, 128.8, 128.7, 128.5, 128.5, 128.3, 128.3, 128.1, 128.0, 128.0, 127.9, 127.8, 127.8, 127.7, 127.6, 127.5, 98.8 (C-1''), 92.5, 92.1 (C-1'), 88.8 (C-1), 77.6 (C-3), 76.7 (C-4'), 76.2 (C-3'), 75.8 (C-2), 75.8, 74.6 (C-5), 74.5 (C-2''), 73.2, 71.9, 71.5 (C-3''), 70.1 (C-5'), 68.2 (C-4), 67.4 (C-6), 67.1, 65.5 (C-5''), 59.6 (C-2''), 52.8 (C-4''), 29.9, 29.5, 27.8, 27.7, 23.7, 20.8, 16.4 (C-6'').  $[\alpha]_{\text{D}}^{20} = +135^\circ$  (c = 0.4,  $\text{CHCl}_3$ ). IR (neat): 697, 740, 827, 969, 1039, 1092, 1167, 1212, 1237, 1456, 1726, 2109, 2858, 2925. HR-MS:

Phenyl (2-*O*-benzyl-3-*O*-[benzyl 2,3-di-*O*-benzyl-4-*O*-[2-azide-4-*N*-Cbz-6-deoxy-1- $\alpha$ -D-galactopyranoside]- $\alpha$ -D-galactopyranosyl urinate]-4,6-di-*tert*-butyl-silylidene-1-thio- $\beta$ -D-galactopyranoside) (38):  $^1\text{H}$  NMR (400 MHz,

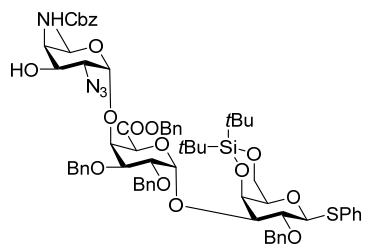

Chloroform-*d*)  $\delta$  7.51 (dd,  $J = 7.8, 1.9$  Hz, 2H), 7.43 – 7.10 (m, 28H), 5.53 (d,  $J = 3.5$  Hz, 1H, H-1'), 5.24 (d,  $J = 12.1$  Hz, 1H), 5.11 (s, 2H), 5.05 – 4.85 (m, 4H), 4.71 (d,  $J = 2.8$  Hz, 1H, H-4), 4.68 – 4.55 (m, 6H, H-1, H-1''), 4.55 – 4.47 (m, 1H, H-5'), 4.32 – 4.24 (m, 1H, H-5''), 4.24 – 4.11 (m, 3H, H-4', H-6), 4.00 (m, 2H, H-3'', H-2'), 3.84 (m, 3H, H-4'', H-3', H-2), 3.69 (dd,  $J = 9.4, 2.8$  Hz, 1H, H-3), 3.27 (d,  $J = 2.1$  Hz, 1H, H-5), 2.94 (dd,  $J = 10.7, 3.8$  Hz, 1H, H-2''), 1.08 (s, 9H), 1.02 (s, 9H), 0.79 (d,  $J = 6.4$  Hz, 3H, H-6'').  $^{13}\text{C}$  NMR (101 MHz,  $\text{CDCl}_3$ )  $\delta$  167.9, 158.4, 138.3, 138.1, 138.1, 136.0, 135.0, 134.8, 132.1, 128.9, 128.8, 128.8, 128.7, 128.6, 128.6, 128.5, 128.5, 128.5, 128.3, 128.3, 128.0, 127.9, 127.9, 127.8, 127.7, 127.7, 127.7, 127.6, 127.5, 99.1 (C-1''), 92.1 (C-1'), 88.8 (C-1), 77.6 (C-1), 76.7 (C-4'), 76.3 and 76.0 (C-3', C-2), 75.8, 74.6 (C-5), 74.4 (C-2''), 73.2, 71.8, 70.1 (C-5'), 68.8 (C-3'', C-4), 68.3 (C-4'), 67.7, 67.48, 67.4 (C-6), 65.1 (C-5''), 60.8 (C-2''), 56.0 (C-4''), 29.8, 27.8, 27.7, 23.4, 20.8, 16.4 (C-6'').  $[\alpha]_{\text{D}}^{20} = +107^\circ$  (c = 1.0,  $\text{CHCl}_3$ ). IR (neat): 655, 697, 735, 827, 968, 1028, 1091, 1167, 1213, 1458, 1507, 1706, 2110, 2358, 2856. HR-MS:  $[\text{M}+\text{Na}^+]$  Calculated for  $\text{C}_{68}\text{H}_{80}\text{N}_4\text{O}_{16}\text{SSi}$ : 1275.5002; found: 1275.5022.

Phenyl (2-*O*-benzyl-3-*O*-[benzyl 2,3-di-*O*-benzyl-4-*O*-[2-azide-3-*O*-levulinoyl-4-*N*-Cbz-6-deoxy-1- $\alpha$ -D-galactopyranoside]- $\alpha$ -D-galactopyranosyl urinate]-4,6-di-*tert*-butyl-silylidene-1-thio- $\beta$ -D-galactopyranoside) (39):

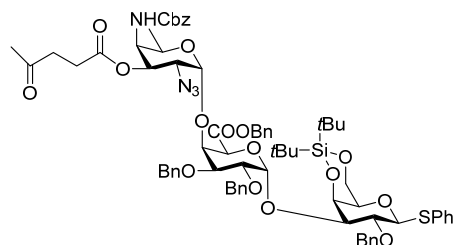

Donor **15** (890 mg, 1.5 mmol) and acceptor **36** (950 mg, 1.0 mmol) were co-evaporated with toluene (three times). The residue was dissolved in dry DCM (0.93 ml) and stirred for 30 min with activated 5Å molecular sieves at room temperature. The solution was cooled to 0 °C, followed by the addition of TBSOTf (23  $\mu\text{l}$ , 0.1 mmol) and the reaction

was allowed to stir for 4 h at 0 °C. The reaction was quenched with Et<sub>3</sub>N (30 ul) and diluted with DCM, washed with sat. aq. NaCl. The organic phase was dried over Na<sub>2</sub>SO<sub>4</sub> and concentrated in vacuo. Purification by column chromatography yielded the product ( $\alpha/\beta = 13:1$ ) 1.152 g, yield: 85%. *R<sub>f</sub>* = 0.14 (pentane/DCM/EtOAc, 6:1:1, v/v/v). <sup>1</sup>H NMR (400 MHz, Chloroform-*d*)  $\delta$  7.51 (dd, *J* = 7.6, 1.9 Hz, 2H), 7.44 – 7.08 (m, 28H), 5.53 (d, *J* = 3.5 Hz, 1H, H-1'), 5.25 (d, *J* = 12.2 Hz, 1H), 5.18 – 4.78 (m, 7H, H-3''), 4.75 – 4.57 (m, 7H, H-4, H-1, H-1''), 4.48 (s, 1H, H-5'), 4.39 – 4.26 (m, 1H, H-5''), 4.24 – 4.10 (m, 3H, H-4', H-6), 4.05 (m, 2H, H-4'', H-2'), 3.90 – 3.79 (m, 2H, H<sub>2</sub>, H-3'), 3.67 (dd, *J* = 9.4, 2.8 Hz, 1H, H-3), 3.25 (s, 1H, H-5), 3.17 (dd, *J* = 11.2, 3.9 Hz, 1H, H-2''), 2.88 – 2.34 (m, 4H), 2.17 (s, 3H), 1.07 (s, 9H), 1.01 (s, 9H), 0.74 (d, *J* = 6.3 Hz, 3H, H-6''). <sup>13</sup>C NMR (101 MHz, CDCl<sub>3</sub>)  $\delta$  206.5, 172.0, 167.9, 156.6, 138.3, 138.1, 138.0, 136.4, 134.9, 134.8, 132.1, 128.9, 128.8, 128.7, 128.7, 128.6, 128.6, 128.4, 128.4, 128.4, 128.4, 128.3, 128.1, 128.1, 127.9, 127.8, 127.8, 127.7, 127.7, 127.6, 127.5, 127.2, 98.9 (C-1''), 92.1 (C-1'), 88.8 (C-1), 77.7 (C-3), 76.8 (C-4'), 76.2, 75.8 (C-2, C-3'), 75.7, 74.7, 74.6 (C-2', C-5), 73.3, 72.0, 70.3 (C-3''), 70.0 (C-5'), 68.3 (C-4), 67.4 (C-6), 67.1, 64.9 (C-5''), 57.8 (C-2''), 52.7 (C-4''), 38.1, 29.9, 28.1, 27.8, 27.7, 23.3, 20.7, 16.1 (C-6''). [ $\alpha$ ]<sub>D</sub><sup>20</sup> = +72° (c = 1.0, CHCl<sub>3</sub>). IR (neat): 651, 697, 737, 827, 969, 1029, 1092, 1149, 1262, 1363, 1714, 2111, 2858, 2931. HR-MS: [M+Na<sup>+</sup>] Calculated for C<sub>73</sub>H<sub>86</sub>N<sub>4</sub>O<sub>17</sub>Si: 1373.5370; found: 1373.5414.

**2-O-benzyl-3-O-[benzyl 2,3-di-O-benzyl-4-O-[2-azide-3-O-levulinoyl-4-N-Cbz-6-deoxy-1- $\alpha$ -D-galactopyranoside]- $\alpha$ -D-galactopyranosyl urinate]-4,6-di-*tert*-butylsilylidene-1- $\alpha/\beta$ -D-galactopyranoside:** The title compound was obtained

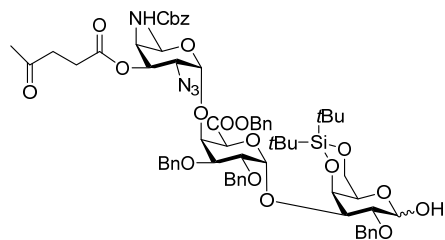

as described in the general procedure for hydrolysis of thioglycosidic bond from compound **39**. 1.642 g, yield: 90%. *R<sub>f</sub>* = 0.07 (pentane/DCM/EtOAc, 2:1:1, v/v/v). <sup>13</sup>C NMR (101 MHz, CDCl<sub>3</sub>)  $\delta$  206.7, 172.0, 168.3, 156.8, 138.2, 137.7, 136.5, 135.1, 128.8, 128.7, 128.6, 128.5, 128.4, 128.4, 128.1, 128.1, 127.9, 127.8, 127.7, 127.7, 99.0, 97.8, 92.4, 92.3,

92.0, 78.0, 77.5, 75.8, 75.5, 75.1, 74.8, 74.6, 73.5, 73.3, 73.1, 72.8, 72.1, 72.0, 71.5, 70.5, 70.4, 70.3, 70.0, 69.4, 68.4, 67.5, 67.3, 67.3, 67.2, 65.0, 58.0, 57.9, 52.8, 38.1, 30.4, 29.7, 28.1, 27.8, 27.5, 27.3, 23.3, 22.8, 20.8, 20.7, 16.2. [ $\alpha$ ]<sub>D</sub><sup>20</sup> = +68° (c = 0.25, CHCl<sub>3</sub>). IR (neat): 651, 697, 744, 827, 975, 1037, 1096, 1260, 1363, 1717, 2111, 2855, 2924. HR-MS: [M+Na<sup>+</sup>] Calculated for C<sub>67</sub>H<sub>82</sub>N<sub>4</sub>O<sub>18</sub>Si: 1281.5286; found: 1281.5328.

**2-O-benzyl-3-O-[benzyl 2,3-di-O-benzyl-4-O-[2-azide-3-O-levulinoyl-4-N-Cbz-6-deoxy-1- $\alpha$ -D-galactopyranoside]- $\alpha$ -D-galactopyranosyl urinate]-4,6-di-*tert*-butylsilylidene-1-**

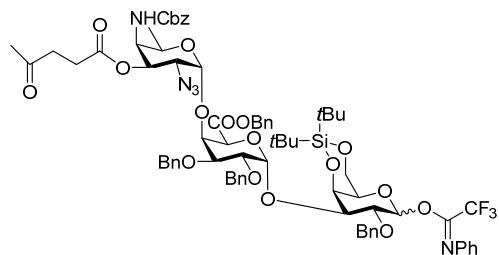

**O-(N-phenyl-trifluoroacetimidoyl)- $\alpha/\beta$ -D-galactopyranoside (13):** The title compound was obtained as described in the general procedure to yield *N*-phenyl-trifluoroacetimidate donor. 1.024 g, yield: 89%. *R<sub>f</sub>* = 0.24 (pentane/DCM/EtOAc, 5:1:1, v/v/v). <sup>1</sup>H

## Chapter 7

NMR (400 MHz, Chloroform-*d*)  $\delta$  7.48 – 7.03 (m, 27H), 6.82 (d,  $J$  = 7.8 Hz, 1H), 6.70 (d,  $J$  = 7.8 Hz, 2H), 6.47 (bs, 1H, H-1), 5.49 (bs, 1H, H-1'), 5.39 – 4.94 (m, 5H, H-3''), 4.85 (dd,  $J$  = 13.5, 7.3 Hz, 2H), 4.78 – 4.47 (m, 7H, H-1'', H-5'), 4.47 – 4.25 (m, 2H, H-5'', H-4'), 4.23 – 3.93 (m, 5H, H-6, H-4'', H-3, H-2'), 3.92 – 3.76 (m, 1H, H-3'), 3.18 (m, 1H, H-2''), 2.88 – 2.34 (m, 4H), 2.18 (d,  $J$  = 1.6 Hz, 3H), 1.06 – 0.93 (m, 12H), 0.88 (s, 6H), 0.82 – 0.74 (m, 3H, H-6'').  $^{13}\text{C}$  NMR (101 MHz,  $\text{CDCl}_3$ )  $\delta$  206.5, 172.0, 168.1, 168.0, 156.7, 143.7, 138.3, 138.2, 138.2, 138.1, 137.8, 136.5, 135.0, 129.3, 128.9, 128.8, 128.8, 128.7, 128.7, 128.7, 128.6, 128.5, 128.5, 128.4, 128.4, 128.4, 128.3, 128.1, 128.1, 128.1, 128.0, 127.9, 127.9, 127.9, 127.8, 127.8, 127.8, 127.7, 127.7, 127.3, 124.3, 119.5, 98.9, 98.8 (C-1''), 92.6, 92.4 (C-1'), 76.6 (C-4'), 76.1, 75.8, 75.7, 75.4 (C-3'), 74.9, 74.7 (C-2'), 73.5, 73.3, 73.2, 72.3, 72.2 (C-3), 72.1, 71.9, 70.3, 70.1, 70.0, 69.97 (C-3'', C-5'), 69.0, 68.2, 67.6, 67.5, 67.1, 66.8, 65.0 (C-5''), 57.8 (C-2''), 52.8 (C-4''), 38.1, 29.9, 28.8, 28.1, 27.8, 27.7, 27.3, 27.2, 23.3, 23.3, 20.8, 20.7, 16.2, 16.1 (C-6'').  $[\alpha]_D^{20}$  = +118° ( $c$  = 1.0,  $\text{CHCl}_3$ ). IR (neat): 651, 698, 735, 827, 857, 979, 1002, 1058, 1098, 1146, 1213, 1456, 1721, 2110, 2856, 2925. HR-MS:  $[\text{M}+\text{Na}^+]$  Calculated for  $\text{C}_{75}\text{H}_{86}\text{N}_5\text{O}_{18}\text{F}_3\text{Si}$ : 1452.5581; found: 1452.5610.

**3-butenyl (2-O-benzyl-3-O-[benzyl 2,3-di-O-benzyl-4-O-{2-azide-3-O-levulinoyl-4-N-Cbz-6-deoxy-1- $\alpha$ -D-galactopyranoside]- $\alpha$ -D-galactopyranosyl urinate]-4,6-di-*tert*-butylsilylidene-1-O- $\alpha$ -D-galactopyranoside) (40):** Donor

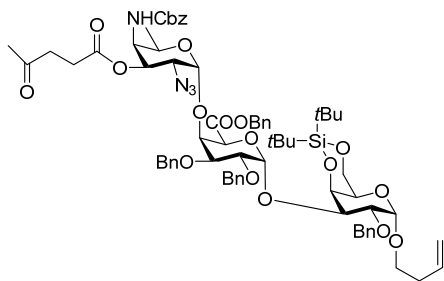

**13** (1.024 g, 0.716 mmol) was co-evaporated with toluene (three times) and acceptor allylcarbinol (187  $\mu\text{l}$ , 2.16 mmol) was added. The residue was dissolved in dry DCM (7.2 ml) and stirred for 30 min with activated 4A molecular sieves at room temperature. The solution was cooled to 0 °C, followed by the addition of TBSOTf (17  $\mu\text{l}$ , 0.07 mmol) and the reaction was allowed to stir for 3 h at 0 °C. The reaction was quenched with  $\text{Et}_3\text{N}$  (30  $\mu\text{l}$ ) and diluted with DCM,

washed with sat. aq. NaCl. The organic phase was dried over  $\text{Na}_2\text{SO}_4$  and concentrated in vacuo. Purification by column chromatography yielded the product ( $\alpha$  only) 771 mg, yield: 82%.  $R_f$  = 0.4 (toluene/EtOAc, 4:1, v/v).  $^1\text{H}$  NMR (400 MHz, Chloroform-*d*)  $\delta$  7.53 – 7.09 (m, 25H), 5.74 (m, 1H), 5.57 (d,  $J$  = 3.5 Hz, 1H, H-1'), 5.29 (d,  $J$  = 12.2 Hz, 1H), 5.21 – 4.95 (m, 6H, H-3''), 4.90 (dd,  $J$  = 10.4, 4.8 Hz, 2H), 4.78 – 4.47 (m, 9H, H-1'', H-4, H-1', H-5', H-5''), 4.35 (d,  $J$  = 2.9 Hz, 1H, H-4'), 4.23 – 3.86 (m, 7H, H-6, H-4'', H-2', H-3, H-3', H-2), 3.58 (m, 2H, H-5), 3.47 (dt,  $J$  = 9.9, 6.8 Hz, 1H), 3.22 (dd,  $J$  = 11.2, 3.9 Hz, 1H, H-2''), 2.90 – 2.37 (m, 4H), 2.36 – 2.24 (m, 2H), 2.17 (s, 3H), 0.99 (s, 9H), 0.83 (d,  $J$  = 3.0 Hz, 12H, H-6'').  $^{13}\text{C}$  NMR (101 MHz,  $\text{CDCl}_3$ )  $\delta$  206.5, 172.0, 168.1, 156.6, 138.4, 138.3, 138.2, 136.4, 135.0, 134.9, 128.8, 128.7, 128.7, 128.6, 128.6, 128.5, 128.4, 128.4, 128.4, 128.3, 128.1, 127.9, 127.8, 127.8, 127.8, 127.6, 116.8, 98.9 (C-1'), 97.9 (C-1), 91.8 (C-1), 77.0 (C-4'), 75.1 (C-3'), 75.0 (C-2'), 73.5, 73.1, 72.7 (C-3), 72.4 (C-2), 71.7, 70.5 (C-3''), 70.3 (C-5'), 69.4 (C-4), 67.5, 67.4, 67.1, 67.1 (C-5), 64.9 (C-5''), 57.9 (C-2''), 52.8 (C-4''), 38.1, 33.9, 29.9, 29.8, 28.1, 27.8, 27.2, 23.3, 20.6, 16.2 (C-6''). IR (neat): 615, 698, 975, 1040, 1101, 1150, 1242, 1338, 1506, 1521, 1717, 1732, 2112, 2916, 2930. HR-MS:  $[\text{M}+\text{Na}^+]$  Calculated for  $\text{C}_{71}\text{H}_{88}\text{N}_4\text{O}_{18}\text{Si}$ : 1335.5755; found: 1335.5792.



**3-butenyl (2-O-benzyl-3-O-[benzyl 2,3-di-O-benzyl-4-O-[2-azide-4-N-Cbz-6-deoxy-1- $\alpha$ -D-galactopyranoside]- $\alpha$ -D-galactopyranosyl urinate]-4,6-di-*tert*-butyl-silylidene-1-O- $\alpha$ -D-galactopyranoside) (41):**

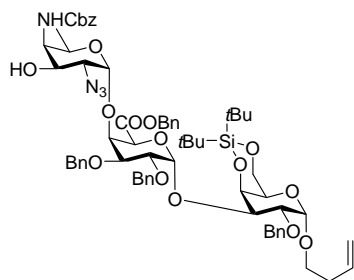

The title compound was obtained by general procedure for delevulinoylation from compound **40**. 670 mg, yield: 98%. *R<sub>f</sub>* = 0.26 (toluene/EtOAc, 4:1). <sup>1</sup>H NMR (400 MHz, Chloroform-*d*) δ 7.46 – 7.10 (m, 25H), 5.74 (m, 1H), 5.57 (d, *J* = 3.2 Hz, 1H, H-1'), 5.29 (d, *J* = 12.1 Hz, 1H), 5.15 – 4.96 (m, 6H), 4.89 (d, *J* = 11.7 Hz, 1H), 4.76 – 4.65 (m, 4H, H-4), 4.67 – 4.54 (m, 4H, H-5'), 4.48 (d, *J* = 12.1 Hz, 1H), 4.43 – 4.28 (m, 2H, H-5'', H-4''), 4.24 – 3.82 (m, 8H, H-2', H-3', H-4''),

3.68 – 3.37 (m, 3H, H-5), 3.00 (dd, *J* = 10.7, 3.8 Hz, 1H, H-2''), 2.29 (qt, *J* = 6.8, 1.4 Hz, 2H), 1.00 (s, 9H), 0.87 (d, *J* = 11.0 Hz, 12H, H-6''). <sup>13</sup>C NMR (101 MHz, CDCl<sub>3</sub>) δ 168.1, 158.3, 138.4, 138.3, 138.2, 136.0, 135.1, 134.9, 128.9, 128.8, 128.7, 128.7, 128.6, 128.6, 128.4, 128.4, 128.4, 128.3, 128.3, 128.2, 127.9, 127.8, 127.8, 127.7, 127.5, 126.7, 125.1, 116.8, 99.1 (C-1''), 97.8 (C-1), 91.9 (C-1'), 76.7 (C-4'), 75.3, 74.71 (C-2', C-3'), 73.4, 72.9, 72.7, 72.5 (C-2, C-3), 71.5, 70.4 (C-5'), 69.5 (C-4), 68.8 (C-3''), 67.6, 67.5, 67.4, 67.1, 67.1 (C-5), 65.1 (C-5'), 60.8 (C-2''), 56.04 (C-4''), 33.9, 27.8, 27.2, 23.3, 20.6, 16.4 (C-6''). [α]<sub>D</sub><sup>20</sup> = +122° (c = 1.0, CHCl<sub>3</sub>). IR (neat): 650, 698, 737, 799, 976, 999, 1028, 1082, 1101, 1261, 1456, 1516, 1716, 2110, 2858, 2932. HR-MS: [M+Na<sup>+</sup>] Calculated for C<sub>66</sub>H<sub>82</sub>N<sub>4</sub>O<sub>16</sub>Si: 1237.5387; found: 1237.5396.

**3-butenyl (2-O-benzyl-3-O-[benzyl 2,3-di-O-benzyl-4-O-[2-azide-3-O-BOM-4-N-Cbz-6-deoxy-1- $\alpha$ -D-galactopyranoside]- $\alpha$ -D-galactopyranosyl urinate]-4,6-di-*tert*-butyl-silylidene-1-O- $\alpha$ -D-galactopyranoside) (42):**

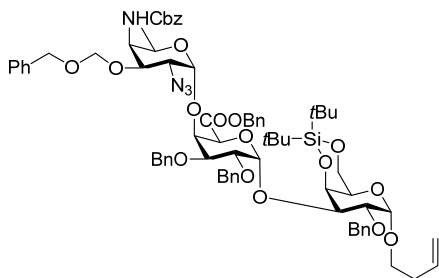

The title compound was obtained by general procedure for BOM protection from compound **41**. 112 mg, yield: 84%. *R<sub>f</sub>* = 0.25 (pentane/EtOAc, 5:1). <sup>1</sup>H NMR (400 MHz, Chloroform-*d*) δ 7.50 – 7.07 (m, 30H), 5.74 m, 1H), 5.57 (d, *J* = 3.4 Hz, 1H, H-1'), 5.31 (d, *J* = 12.1 Hz, 1H), 5.17 – 4.95 (m, 6H), 4.87 (dd, *J* = 10.7, 8.8 Hz, 2H), 4.81 – 4.44 (m, 12H, H-1'', H-4, H-5'), 4.41 – 4.27 (m, 2H, H-4', H-5''), 4.25 – 3.83 (m, 8H, H-6, H-3'', H-4'', H-2', H-2, H-3', H-3), 3.68 – 3.38 (m,

3H, H-5), 3.02 (dd, *J* = 10.9, 3.9 Hz, 1H, H-2''), 2.30 (qt, *J* = 6.9, 1.4 Hz, 2H), 0.99 (s, 9H), 0.86 (d, *J* = 15.3 Hz, 12H, H-6''). <sup>13</sup>C NMR (101 MHz, CDCl<sub>3</sub>) δ 168.08, 156.91, 138.42, 138.33, 138.23, 137.79, 136.45, 135.05, 134.97, 128.91, 128.73, 128.66, 128.63, 128.51, 128.46, 128.45, 128.41, 128.29, 128.24, 128.08, 127.91, 127.85, 127.82, 127.77, 127.54, 116.78, 98.82 (C-1''), 97.89 (C-1), 92.51, 91.84 (C-1'), 76.71 (C-4'), 75.20 (C-2'), 74.86 (C-3'), 73.45, 73.05, 72.66, 72.46 (C-2, C-3), 71.65 (C-3''), 71.60, 70.38 (C-5'), 70.07, 69.42 (C-4), 67.53, 67.44, 67.19, 67.11 (C-5), 67.08 (C-6), 65.49 (C-5''), 59.72 (C-2''), 52.88 (C-4''), 33.93, 27.84, 27.27, 23.31, 20.66, 16.47 (C-6''). [α]<sub>D</sub><sup>20</sup> = +119° (c =

## Chapter 7

1.0, CHCl<sub>3</sub>). IR (neat): 650, 696, 734, 826, 908, 997, 1036, 1457, 1507, 1653, 1700, 1717, 2109, 2857, 2931. HR-MS: [M+Na<sup>+</sup>] Calculated for C<sub>74</sub>H<sub>90</sub>N<sub>4</sub>O<sub>17</sub>Si: 1357.5962; found: 1357.5975.

**3-butenyl (2-O-benzyl-3-O-[benzyl 2,3-di-O-benzyl-4-O-[2-azide-3-O-BOM-4-N-Cbz-6-deoxy-1- $\alpha$ -D-galactopyranoside]- $\alpha$ -D-galactopyranosyl urinate]-1-O- $\alpha$ -D-galactopyranoside) (43):** The title compound was

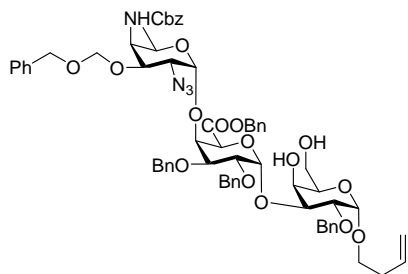

obtained by general procedure for deprotecting of the di-*tert*-butyl silylidene ketal from compound **42**. 140 mg, yield: 94%. *R<sub>f</sub>* = 0.34 (pentane/EtOAc, 1:1). <sup>1</sup>H NMR (400 MHz, Chloroform-*d*)  $\delta$  7.46 – 7.11 (m, 30H), 5.78 (m, 1H), 5.22 (d, *J* = 12.1 Hz, 1H), 5.15 – 4.95 (m, 6H, H-1'), 4.90 (d, *J* = 9.9 Hz, 1H, N-H), 4.85 (d, *J* = 3.6 Hz, 1H, H-1), 4.82 – 4.59 (m, 7H, H-1''), 4.47 (d, *J* = 14.5 Hz, 3H, H-5'), 4.36 (d, *J* = 2.8 Hz, 1H, H-4'), 4.34 – 4.26 (m, 1H, H-5''), 4.18 – 4.00 (m, 3H, H-3'', H-4'', H-5), 3.90 (m, 3H, H-2', H-4, H-6),

3.83 – 3.70 (m, 4H, H-3', H-2, H-3, H-6), 3.65 (m, 1H), 3.45 (m, 1H), 2.98 (dd, *J* = 10.8, 4.0 Hz, 1H, H-2''), 2.42 – 2.28 (m, 2H), 0.87 (d, *J* = 6.3 Hz, 3H, H-6''). <sup>13</sup>C NMR (101 MHz, CDCl<sub>3</sub>)  $\delta$  167.9, 156.8, 138.2, 137.9, 137.7, 137.1, 136.3, 134.9, 134.8, 128.9, 128.8, 128.7, 128.7, 128.6, 128.6, 128.5, 128.4, 128.4, 128.4, 128.3, 128.2, 128.0, 127.9, 127.8, 127.8, 127.8, 127.4, 116.8, 98.4 (C-1''), 96.9 (C-1), 94.1 (C-1'), 92.4, 76.2 (C-3'), 75.9 (C-4'), 75.0 (C-2'), 74.8, 74.4 (C-2), 74.2 (C-3), 72.8, 72.4, 71.2 (C-3''), 70.5 (C-5'), 70.1, 68.9 (C-5), 67.5, 67.4, 67.4 (C-4), 67.0, 65.5 (C-5''), 63.4 (C-6), 59.3 (C-2''), 52.7 (C-4''), 33.8, 16.4 (C-6'').  $[\alpha]_D^{20} = 123^\circ$  (c = 0.32, CHCl<sub>3</sub>). IR (neat): 698, 735, 986, 1028, 1035, 1096, 1238, 1263, 1338, 1454, 1497, 1717, 2108, 2926. HR-MS: [M+Na<sup>+</sup>] Calculated for C<sub>66</sub>H<sub>74</sub>N<sub>4</sub>O<sub>17</sub>: 1217.4941; found: 1217.4946.

**Benzyl (3-butenyl 2-O-benzyl-3-O-[benzyl 2,3-di-O-benzyl-4-O-[2-azide-3-O-BOM-4-N-Cbz-6-deoxy-1- $\alpha$ -D-galactopyranoside]- $\alpha$ -D-galactopyranosyl urinate]-1-O- $\alpha$ -D-galactopyranosyl uronate) (44):** Compound **43** (135 mg,

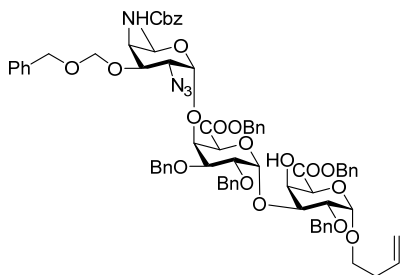

0.113 mmol) was dissolved in DCM/*tert*-BuOH/H<sub>2</sub>O (2.25 ml, 4/4/1,v/v/v). The mixture was cooled to 0 °C and treated with TEMPO (3.5 mg, 0.023 mmol) and BAIB (91 g, 0.282 mmol). After stirring for overnight at 4 0 °C, Na<sub>2</sub>S<sub>2</sub>O<sub>3</sub> was added, the mixture was diluted with EtOAc, washed with sat. aq. NaCl and the organic phase was dried over Na<sub>2</sub>SO<sub>4</sub> and concentrated *in vacuo*. The crude residue was dissolved in DMF (1 ml), followed by addition of Cs<sub>2</sub>CO<sub>3</sub> (37 mg, 0.113 mmol) and BnBr (27  $\mu$ l, 0.226

mmol) at 0 °C. The mixture was allowed to stir overnight at room temperature, and then diluted with EtOAc, washed with sat. aq. NaCl. The organic phase was dried over Na<sub>2</sub>SO<sub>4</sub> and concentrated *in vacuo*. Purification by column chromatography (silica gel, pentane /EtOAc, 4:1 $\rightarrow$ 2:1, v/v) yielded **44** (124 mg, two steps yield 84%). TLC:

$R_f = 0.82$  (pentane/EtOAc, 3/2, v/v).  $^1\text{H NMR}$  (400 MHz, Chloroform-*d*)  $\delta$  7.47 – 7.25 (m, 25H), 7.22 – 7.09 (m, 10H), 5.75 (m, 1H), 5.37 – 5.25 (m, 2H), 5.22 (d,  $J = 12.1$  Hz, 1H), 5.14 – 4.95 (m, 6H), 4.95 – 4.83 (m, 3H, H-1, H-1'), 4.80 – 4.56 (m, 8H, H-1''), 4.52 – 4.38 (m, 4H, H-5, H-5'), 4.36 – 4.24 (m, 3H, H-4', H-4, H-5''), 4.10 (m, 3H, H-3, H-3'', H-4''), 3.91 – 3.71 (m, 3H, H-2', H-2, H-3'), 3.67 (m, 1H), 3.49 (m, 1H), 2.98 (dd,  $J = 10.6, 4.0$  Hz, 1H, H-2''), 2.38 – 2.24 (m, 2H), 0.88 (d,  $J = 6.3$  Hz, 3H, H-6'').  $^{13}\text{C NMR}$  (101 MHz,  $\text{CDCl}_3$ )  $\delta$  168.4, 167.9, 156.8, 138.0, 137.9, 137.7, 136.9, 136.3, 135.4, 134.8, 134.7, 128.9, 128.8, 128.7, 128.7, 128.6, 128.6, 128.6, 128.5, 128.5, 128.4, 128.4, 128.3, 128.3, 128.2, 128.2, 128.0, 127.9, 127.9, 127.7, 127.4, 117.0, 98.4 (C-1''), 97.2 (C-1), 94.3 (C-1'), 92.4, 76.0 (C-3'), 76.0 (C-4'), 74.3, 73.9 and 73.9 (C-3, C-2, C-2'), 72.8, 72.7, 71.3 (C-3''), 70.5 and 69.5 (C-5, C-5') 70.0, 68.0, 67.4, 67.0, 67.0, 66.8 (C-4), 65.5 (C-5''), 59.3 (C-2''), 52.7 (C-4''), 33.8, 16.4.  $[\alpha]_D^{20} = +123^\circ$  ( $c = 1.0$ ,  $\text{CHCl}_3$ ). IR (neat): 698, 737, 1039, 1099, 1236, 1456, 1506, 1521, 1717, 2108, 2326, 2934. HR-MS:  $[\text{M}+\text{Na}^+]$  Calculated for  $\text{C}_{73}\text{H}_{78}\text{N}_4\text{O}_{18}$ : 1321.5203; found: 1321.5215.

**Benzyl (3-butenyl 2-O-benzyl-3-O-[benzyl 2,3-di-O-benzyl-4-O-[2-acetylamino-3-O-BOM-4-N-Cbz-6-deoxy-1- $\alpha$ -D-galactopyranoside]- $\alpha$ -D-galactopyranosyl urinate]-1-O- $\alpha$ -D-galactopyranosyl uronate) (5):**  $^1\text{H NMR}$  (400 MHz, Chloroform-*d*)

$\delta$  7.45 – 7.25 (m, 25H), 7.21 (bs, 5H), 7.12 (bs, 5H), 5.75 (m, 1H), 5.61 (d,  $J = 9.5$  Hz, 1H, N-H), 5.40 – 5.23 (m, 2H), 5.19 – 4.96 (m, 7H), 4.95 – 4.83 (m, 4H, H-1, H-1'), 4.75 (dd,  $J = 12.3, 3.4$  Hz, 2H), 4.71 – 4.57 (m, 5H), 4.50 (d,  $J = 3.9$  Hz, 1H, H-1''), 4.46 – 4.35 (m, 5H, H-5, H-5'), 4.28 (m, 2H, H-4, H-5''), 4.20 – 4.02 (m, 4H, H-4', H-4'', H-3, H-2''), 3.86 – 3.61 (m, 5H, H-2, H-2', H-3', H-3''), 3.52 (m, 1H), 2.41 – 2.29 (m, 2H), 0.90 (d,  $J = 6.3$  Hz, 3H, H-6'').  $^{13}\text{C NMR}$  (101 MHz,  $\text{CDCl}_3$ )  $\delta$  170.9, 168.5, 168.1, 157.1, 137.9, 137.8, 137.8, 136.8, 135.5, 134.8, 134.2, 129.1, 129.0, 129.0, 128.9, 128.7, 128.7, 128.7, 128.6, 128.6, 128.5, 128.4, 128.2, 128.1, 128.1, 128.0, 127.9, 127.7, 117.1, 99.8 (C-1''), 97.1 (C-1), 94.5 (C-1'), 92.5, 77.1 (C-4'), 75.9 (C-3'), 74.4, 74.3 (C-3), 74.1 (C-2), 73.3 (C-2'), 73.0, 73.0, 72.3 (C-3''), 70.9 (C-5'), 69.6 (C-5), 68.1, 67.6, 67.3, 67.1, 66.9 (C-4), 66.2 (C-5''), 52.8 (C-4''), 48.5 (C-2''), 33.9, 23.7, 16.6 (C-6'').  $[\alpha]_D^{20} = +85^\circ$  ( $c = 0.5$ ,  $\text{CHCl}_3$ ). IR (neat): 697, 733, 1028, 1038, 1097, 1244, 1457, 1507, 1558, 1653, 1700, 2931, 3735. HR-MS:  $[\text{M}+\text{Na}^+]$  Calculated for  $\text{C}_{75}\text{H}_{82}\text{N}_2\text{O}_{19}$ : 1337.5404; found: 1337.5421.

$\text{CH}_2=\text{CHCH}_2\text{CH}_2\text{O}(\text{CH}_2\text{CH}_2\text{O})_4\text{CH}_2\text{CH}_2\text{CH}=\text{CH}_2$ : 3-butenol (11.7 ml, 136 mmol) was added to DMF (100 ml), then NaH (60% in oil, 8.2 g, 204.24 mmol) was slowly added to the reaction mixture at 0 °C. After 15 min,  $\text{MsO}(\text{CH}_2\text{CH}_2\text{O})_4\text{Ms}$  (9.7 g, 27.71 mmol) was added to the reaction mixture then the reaction was stirred at room temperature for two days. The reaction was quenched with  $\text{H}_2\text{O}$  and then diluted with  $\text{HCCl}_3$ , washed with sat. aq. NaCl. The organic phase was dried over  $\text{Na}_2\text{SO}_4$  and concentrated *in vacuo*. Purification by column chromatography (silica gel, pentane /EtOAc, 20:1  $\rightarrow$  4:1, v/v) yielded  $\text{CH}_2=\text{CHCH}_2\text{CH}_2\text{O}(\text{CH}_2\text{CH}_2\text{O})_4\text{CH}_2\text{CH}_2\text{CH}=\text{CH}_2$  (6.3 g, 68%). TLC:  $R_f = 0.6$  (DCM/MeOH, 20/1, v/v).  $^1\text{H NMR}$  (400 MHz, Chloroform-*d*)  $\delta$  5.82 (m, 2H), 5.17 – 4.96 (m, 4H), 3.71 – 3.56 (m,

## Chapter 7

16H), 3.52 (t,  $J = 6.9$  Hz, 2H), 2.35 (qt,  $J = 6.9, 1.4$  Hz, 4H);  $^{13}\text{C}$  NMR (101 MHz,  $\text{CDCl}_3$ )  $\delta$  135.23, 116.42, 70.73, 70.70, 70.68, 70.65, 70.22, 34.20.

**ZPS-SP 1 Trisaccharide 1:** The compound **5** (10.2 mg) was dissolved in THF (2 ml) and MeOH (0.75 ml), 1 M NaOH (0.8 ml) was added to reaction mixture at 0 °C. The mixture was allowed to stir 48 h at room temperature, and

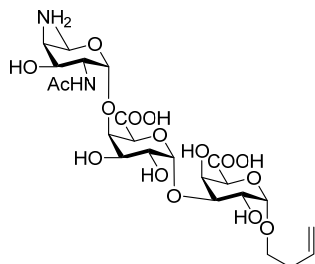

then neutralized by  $\text{H}_2\text{SO}_4$  (1 M). Diluted with EtOAc and the water layer was extracted with EtOAc (2x20 ml). The combined organic layers were washed with brine then dried over  $\text{Na}_2\text{SO}_4$  and concentrated in vacuo. The residue was co-evaporated with toluene (three times) for the next step. Ammonia (10 ml) was condensed at -70 °C, the residue was dissolved in THF (2 ml) and tert-butanol (0.8 ml) and slowly added to reaction flask containing ammonia. Allylcarbinol (50  $\mu\text{l}$ ) was added to the reaction

mixture. Small pieces sodium added to the reaction mixture one by one to keep deep blue for 15 min. Then ammonia acetate (100 mg) was added to reaction mixture. The solution was allowed to come to room temperature and stirred until all of ammonia was evaporated. Then the solution was concentrated in vacuo and purification by gel filtration (HW-40, 0.15M  $\text{NH}_4\text{OAc}$  in  $\text{H}_2\text{O}$ ). The product containing fractions were pooled and lyophilized (4x) to yield the final products as a white solid. The products were transformed into the sodium salts by passing an aqueous solution of the compounds over a short Dowex  $\text{Na}^+$  column, after which the compounds were lyophilized and obtained 4.5 mg, 95% (1/1b, 14:1).  $^1\text{H}$  NMR (500 MHz, Deuterium Oxide)  $\delta$  5.94 – 5.79 (m, 1H,  $-\text{OCH}_2\text{CH}_2\text{CH}=\text{CH}_2$ ), 5.20 (d,  $J = 3.9$  Hz, 1H,  $\text{H}_{\text{B}1}$ ), 5.17 – 5.03 (m, 2H,  $-\text{OCH}_2\text{CH}_2\text{CH}=\text{CH}_2$ ), 4.96 (d,  $J = 4.0$  Hz, 1H,  $\text{H}_{\text{A}1}$ ), 4.93 (d,  $J = 3.8$  Hz, 1H,  $\text{H}_{\text{C}1}$ ), 4.71 (q,  $J = 6.6$  Hz, 1H,  $\text{H}_{\text{C}5}$ ), 4.54 (s, 1H,  $\text{H}_{\text{B}5}$ ), 4.46 (d,  $J = 3.4$  Hz, 1H,  $\text{H}_{\text{A}4}$ ), 4.33 (d,  $J = 3.0$  Hz, 1H,  $\text{H}_{\text{B}4}$ ), 4.26 (d,  $J = 1.3$  Hz, 1H,  $\text{H}_{\text{A}5}$ ), 4.11 (m, 2H,  $\text{H}_{\text{C}3}$ ,  $\text{H}_{\text{B}3}$ ), 4.04 – 3.96 (m, 2H,  $\text{H}_{\text{C}2}$ ,  $\text{H}_{\text{A}3}$ ), 3.93 – 3.84 (m, 2H,  $\text{H}_{\text{A}2}$ ,  $\text{H}_{\text{B}2}$ ), 3.74 (dt,  $J = 10.0, 6.7$  Hz, 1H,  $-\text{OCH}_2\text{CH}_2\text{CH}=\text{CH}_2$ ), 3.69 – 3.58 (m, 1H,  $-\text{OCH}_2\text{CH}_2\text{CH}=\text{CH}_2$ ), 3.53 (d,  $J = 4.4$  Hz, 1H,  $\text{H}_{\text{C}4}$ ), 2.36 (q,  $J = 6.9$  Hz, 2H,  $-\text{OCH}_2\text{CH}_2\text{CH}=\text{CH}_2$ ), 2.08 (d,  $J = 1.1$  Hz, 3H,  $\text{CH}_3\text{CONH}-$ ), 1.23 (d,  $J = 6.7$  Hz, 3H,  $\text{H}_{\text{C}6}$ ).  $^{13}\text{C}$  NMR (126 MHz,  $\text{D}_2\text{O}$ )  $\delta$  175.6, 175.1, 174.7, 136.0, 116.6, 98.9 ( $\text{C}_{\text{C}1}$ ), 98.5 ( $\text{C}_{\text{B}1}$ ), 96.2 ( $\text{C}_{\text{A}1}$ ), 80.2 ( $\text{C}_{\text{B}4}$ ), 75.9 ( $\text{C}_{\text{A}3}$ ), 71.3 and 71.3 ( $\text{C}_{\text{A}5}$  and  $\text{C}_{\text{B}5}$ ), 68.6 ( $\text{C}_{\text{B}3}$ ), 68.1 ( $\text{C}_{\text{B}2}$ ), 68.0 ( $-\text{OCH}_2\text{CH}_2\text{CH}=\text{CH}_2$ ), 67.8 ( $\text{C}_{\text{A}4}$ ), 66.6 ( $\text{C}_{\text{A}2}$ ), 65.1 ( $\text{C}_{\text{C}3}$ ), 63.8 ( $\text{C}_{\text{C}5}$ ), 55.2 ( $\text{C}_{\text{C}4}$ ), 49.3 ( $\text{C}_{\text{C}2}$ ), 33.4 ( $-\text{OCH}_2\text{CH}_2\text{CH}=\text{CH}_2$ ), 22.4 ( $\text{CH}_3\text{CO}$ ), 15.5 ( $\text{C}_{\text{C}6}$ ).  $[\alpha]_{\text{D}}^{20} = +59^\circ$  ( $c = 0.2$ ,  $\text{H}_2\text{O}$ ). HR-MS:  $[\text{M}+\text{H}^+]$  Calculated for  $\text{C}_{24}\text{H}_{38}\text{N}_2\text{O}_{16}$ : 611.2294; found: 611.2302.

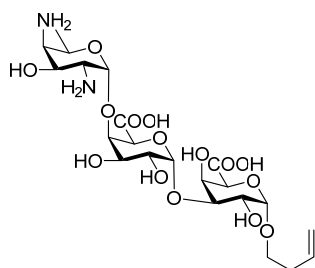

**ZPS-SP 1 Trisaccharide 1b:**  $^1\text{H}$  NMR (400 MHz, Deuterium Oxide)  $\delta$  5.84 (ddt,  $J = 17.1, 10.2, 6.7$  Hz, 1H), 5.19 (d,  $J = 3.9$  Hz, 1H), 5.15 (d,  $J = 4.0$  Hz, 1H), 5.13 – 5.00 (m, 2H), 4.95 (d,  $J = 3.9$  Hz, 1H), 4.75 (d,  $J = 12.1$  Hz, 5H), 4.58 (d,  $J = 1.0$  Hz, 1H), 4.44 (dd,  $J = 3.2, 1.4$  Hz, 1H), 4.37 (dd,  $J = 11.5, 4.1$  Hz, 2H), 4.28 (d,  $J = 1.4$  Hz, 1H), 4.10 (dd,  $J = 10.6, 3.1$  Hz, 1H), 3.96 (dd,  $J = 10.3, 3.1$  Hz, 1H), 3.87 (dt,  $J = 10.3, 3.7$  Hz, 2H), 3.72 (dt,  $J = 10.1, 6.7$  Hz, 1H), 3.66 –

3.56 (m, 2H), 3.32 (dd,  $J = 11.3, 3.9$  Hz, 1H), 2.33 (q,  $J = 6.5$  Hz, 2H), 1.23 (d,  $J = 6.8$  Hz, 3H).  $^{13}\text{C}$  NMR (101 MHz,  $\text{D}_2\text{O}$ )  $\delta$  175.4, 135.9, 116.6, 98.5, 96.1, 95.8, 79.4, 75.6, 71.2, 70.8, 68.3, 67.9, 67.8, 67.6, 66.4, 63.4, 63.1, 55.0, 50.2, 33.3, 15.3.

**Hexasaccharide 45:** The title compound was obtained as described in the general procedure of glycosylation

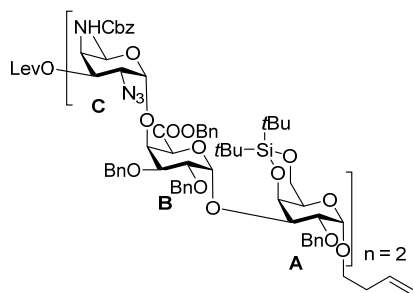

reactions for synthesis long oligosaccharides from trisaccharide

donor **13** and trisaccharide acceptor **41**. 590 mg, yield: 83%. *Rf*

= 0.30 (toluene/EtOAc, 4:1).  $^1\text{H}$  NMR (400 MHz, Chloroform-*d*)  $\delta$  7.46 – 7.09 (m, 50H), 5.74 (m, 1H), 5.59 (d,  $J = 3.5$  Hz, 1H,  $\text{H}_{\text{B}1}$  or  $\text{B}'_1$ ), 5.54 (s, 1H,  $\text{H}_{\text{B}1}$  or  $\text{B}'_1$ ), 5.32 – 4.95 (m, 12H,  $\text{H}_{\text{A}'_1}$ ,  $\text{H}_{\text{C}'_3}$ ), 4.89 (dd,  $J = 10.7, 6.4$  Hz, 4H), 4.79 (d,  $J = 2.8$  Hz, 1H,  $\text{H}_{\text{A}4}$ ), 4.76 – 4.38 (m, 17H,  $\text{H}_{\text{C}1}$ ,  $\text{H}_{\text{C}'_1}$ ,  $\text{H}_{\text{A}1}$ ,  $\text{H}_{\text{B}5}$ ,  $\text{H}_{\text{C}5}$ ), 4.32 – 3.83 (m, 18H,  $\text{H}_{\text{B}4}$ ,  $\text{H}_{\text{B}'_4}$ ,  $\text{H}_{\text{C}4}$ ,  $\text{H}_{\text{C}'_4}$ ,  $\text{H}_{\text{A}2}$ ,  $\text{H}_{\text{A}'_2}$ ,  $\text{H}_{\text{B}2}$ ,  $\text{H}_{\text{B}'_2}$ ,  $\text{H}_{\text{C}3}$ ), 3.72 (s, 1H,  $\text{H}_{\text{A}5}$ ), 3.63 – 3.52 (m, 2H,

$\text{H}_{\text{A}'_5}$ ), 3.47 (dt,  $J = 10.0, 6.8$  Hz, 1H), 3.21 (dd,  $J = 11.2, 3.9$  Hz, 1H,  $\text{H}_{\text{C}'_2}$ ), 3.09 (dd,  $J = 10.9, 4.0$  Hz, 1H,  $\text{H}_{\text{C}2}$ ), 2.88 – 2.34 (m, 4H), 2.36 – 2.24 (m, 2H), 2.16 (s, 3H), 1.02 (d,  $J = 8.6$  Hz, 18H), 0.83 (m, 24H).  $^{13}\text{C}$  NMR (101 MHz,  $\text{CDCl}_3$ )  $\delta$  206.4, 171.9, 168.0, 167.8, 156.9, 156.6, 138.3, 138.3, 138.2, 138.2, 136.4, 136.2, 135.1, 134.9, 134.9, 128.7, 128.7, 128.6, 128.5, 128.5, 128.4, 128.4, 128.4, 128.3, 128.3, 128.2, 128.2, 128.1, 128.1, 128.0, 128.0, 127.8, 127.8, 127.8, 127.7, 127.7, 127.6, 127.6, 127.5, 127.4, 116.7, 98.6 and 98.4 ( $\text{C}_{\text{C}1}$  and  $\text{C}_{\text{C}'_1}$ ), 97.8 ( $\text{C}_{\text{A}1}$ ), 93.1 ( $\text{C}_{\text{A}'_1}$ ), 91.6 and 91.5 ( $\text{C}_{\text{B}1}$  and  $\text{C}_{\text{B}'_1}$ ), 76.9 ( $\text{C}_{\text{B}4}$  and  $\text{C}_{\text{B}'_4}$ ), 75.4, 75.2, 74.9 and 74.6 ( $\text{C}_{\text{B}3}$  and  $\text{C}_{\text{B}'_3}$ ,  $\text{C}_{\text{B}2}$  and  $\text{C}_{\text{B}'_2}$ ), 73.4, 73.2, 73.1, 72.8, 72.6 and 72.3 ( $\text{C}_{\text{A}2}$  and  $\text{C}_{\text{A}3}$ ), 71.6, 71.5, 70.6 and 70.4 ( $\text{C}_{\text{B}5}$ ,  $\text{C}_{\text{C}'_3}$  and  $\text{C}_{\text{A}'_2}$ ), 69.3 ( $\text{C}_{\text{A}4}$ ,  $\text{C}_{\text{A}'_4}$ , and  $\text{C}_{\text{C}3}$ ), 67.4, 67.4, 67.4, 67.2, 67.1, 67.0 ( $\text{C}_{\text{A}5}$ ,  $\text{C}_{\text{A}'_5}$ ), 67.0, 67.0, 65.7 and 64.9 ( $\text{C}_{\text{C}5}$ ,  $\text{C}_{\text{C}'_5}$ ), 59.8 and 57.9 ( $\text{C}_{\text{C}2}$ ,  $\text{C}_{\text{C}'_2}$ ), 52.7 and 50.5 ( $\text{C}_{\text{C}4}$ ,  $\text{C}_{\text{C}'_4}$ ), 38.0, 33.9, 27.9, 27.8, 27.2, 23.3, 23.3, 20.6, 20.6, 16.3 and 16.1 ( $\text{C}_{\text{C}6}$ ,  $\text{C}_{\text{C}'_6}$ ).  $[\alpha]_{\text{D}}^{20} = +135^\circ$  ( $c = 1.0$ ,  $\text{CHCl}_3$ ). IR (neat): 651, 697, 736, 799, 827, 975, 997, 1028, 1036, 1080, 1090, 1146, 1237, 1260, 1456, 1507, 1715, 2108, 2856, 2929. HR-MS:  $[\text{M}+\text{H}^+]$  Calculated for  $\text{C}_{133}\text{H}_{162}\text{N}_8\text{O}_{33}\text{Si}_2$ : 2456.0856; found: 2456.0830.

**Hexasaccharide 46:** The title compound was obtained by general procedure for delevulinoylation from compound

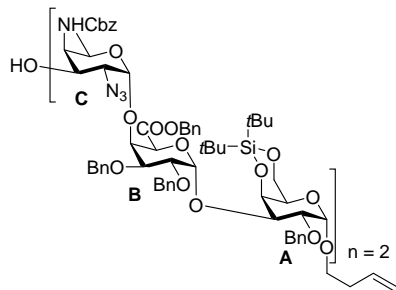

**45**. 283 mg, yield: 97%. *Rf* = 0.24 (toluene/EtOAc, 4:1).  $^1\text{H}$  NMR

(400 MHz, Chloroform-*d*)  $\delta$  7.43 – 7.15 (m, 50H), 5.83 – 5.66 (m, 1H), 5.59 (d,  $J = 3.4$  Hz, 1H,  $\text{H}_{\text{B}1}$  or  $\text{B}'_1$ ), 5.54 (s, 1H,  $\text{H}_{\text{B}1}$  or  $\text{B}'_1$ ), 5.31 – 4.97 (m, 9H,  $\text{H}_{\text{A}'_1}$ ), 4.96 – 4.85 (m, 3H), 4.82 – 4.44 (m, 17H,  $\text{H}_{\text{A}4}$ ,  $\text{H}_{\text{A}'_4}$ ,  $\text{H}_{\text{C}1}$ ,  $\text{H}_{\text{C}'_1}$ ,  $\text{H}_{\text{A}1}$ ,  $\text{H}_{\text{A}'_1}$ ,  $\text{H}_{\text{B}5}$ ,  $\text{H}_{\text{B}'_5}$ ), 4.40 – 3.82 (m, 18H,  $\text{H}_{\text{A}3}$ ,  $\text{H}_{\text{A}'_3}$ ,  $\text{H}_{\text{C}5}$ ,  $\text{H}_{\text{C}'_5}$ ,  $\text{H}_{\text{B}4}$ ,  $\text{H}_{\text{B}'_4}$ ,  $\text{H}_{\text{C}4}$ ,  $\text{H}_{\text{C}'_4}$ ,  $\text{H}_{\text{A}2}$ ,  $\text{H}_{\text{A}'_2}$ ,  $\text{H}_{\text{B}2}$ ,  $\text{H}_{\text{B}'_2}$ ,  $\text{H}_{\text{C}3}$ ,  $\text{H}_{\text{C}'_3}$ ,  $\text{H}_{\text{A}6}$ ,  $\text{H}_{\text{A}'_6}$ ), 3.73 (s, 1H,  $\text{H}_{\text{A}5}$  or  $\text{A}'_5$ ), 3.63 – 3.54 (m, 2H,  $\text{H}_{\text{A}5}$  or  $\text{A}'_5$ ), 3.47 (dt,  $J =$

10.0, 6.7 Hz, 1H), 3.11 (m, 2H,  $\text{H}_{\text{C}2}$ ), 3.00 (dd,  $J = 10.6, 3.8$  Hz, 1H,  $\text{H}_{\text{C}2}$ ), 2.36 – 2.24 (m, 2H), 1.04 (s, 9H), 1.02 (s, 9H), 0.90 – 0.81 (m, 24H,  $\text{H}_{\text{C}6}$ ,  $\text{H}_{\text{C}'_6}$ ).  $^{13}\text{C}$  NMR (101 MHz,  $\text{CDCl}_3$ )  $\delta$  167.9, 167.9, 158.2, 156.8, 138.3, 138.3, 138.2,

## Chapter 7

138.2, 138.1, 136.2, 135.9, 135.1, 134.8, 134.8, 128.8, 128.7, 128.6, 128.6, 128.5, 128.4, 128.4, 128.3, 128.3, 128.2, 128.2, 128.1, 128.0, 127.9, 127.8, 127.7, 127.6, 127.6, 127.5, 127.5, 127.4, 116.7, 98.6 and 98.4 ( $C_{C1}$  and  $C_{C1}$ ), 97.8 and 93.0 ( $C_{A1}$  and  $C_{A'1}$ ), 91.6 and 91.5 ( $C_{B1}$  and  $C_{B'1}$ ), 76.5 ( $C_{B4}$  and  $C_{B'4}$ ), 75.6, 74.9 and 74.5 ( $C_{B3}$  and  $C_{B'3}$ ,  $C_{B2}$  and  $C_{B'2}$ ), 73.3, 73.0; 72.6 and 72.2, 70.7, ( $C_{A'2}$  and  $C_{A3}$ ,  $C_{A2}$  and  $C_{A3}$ ), 71.4, 71.4; 70.4 and 70.3 ( $C_{B5}$  and  $C_{B'5}$ ), 69.3, 69.3 and 68.8 ( $C_{A'4}$ ,  $C_{A4}$  and  $C_{C3}$ ,  $C_{C'3}$ ), 67.5, 67.4, 67.4, 67.3, 67.3, 67.1; 67.0 ( $C_{A5}$  and  $C_{A'5}$ ), 66.9 ( $C_{A6}$  and  $C_{A'6}$ ), 65.6 and 65.1 ( $C_{C5}$  and  $C_{C'5}$ ), 60.8 and 59.8 ( $C_{C2}$  and  $C_{C'2}$ ), 55.9 and 50.5 ( $C_{C4}$  and  $C_{C'4}$ ), 33.8, 27.9, 27.8, 27.7, 27.2, 23.3, 23.2, 20.6, 20.6, 16.3 and 16.2 ( $C_{C6}$  and  $C_{C'6}$ ).  $[\alpha]_D^{20} = +133^\circ$  ( $c = 1.0$ ,  $\text{CHCl}_3$ ). IR (neat): 650, 696, 735, 798, 826, 912, 975, 996, 1028, 1067, 1093, 1240, 1346, 1458, 1498, 1723, 2109, 2875, 2929. HR-MS  $[\text{M}+\text{H}^+]$  Calculated for  $\text{C}_{128}\text{H}_{156}\text{N}_8\text{O}_{31}\text{Si}_2$ : 2358.0488; found: 2358.0405.

**Nonasaccharide 47:** The title compound was obtained as described in the general procedure of glycosylation

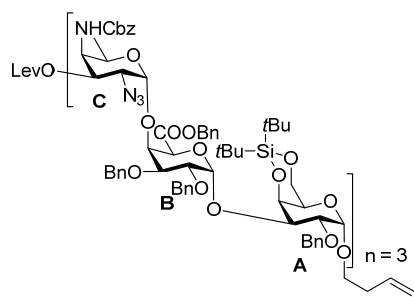

reactions for synthesis long oligosaccharides from trisaccharide donor **13** and hexasaccharide acceptor **46**. 358 mg, yield: 80%.

$R_f = 0.28$  (toluene/EtOAc, 4:1).  $^1\text{H}$  NMR (600 MHz, Chloroform- $d$ )  $\delta$  7.49 – 7.04 (m, 75H), 5.74 (m, 1H), 5.64 – 5.48 (m, 3H,  $3\times\text{H}_{B1}$ ), 5.30 – 4.95 (m, 15H,  $2\times\text{H}_{A1}$ ,  $\text{H}_{C'3}$ ), 4.93 – 4.81 (m, 6H), 4.81 – 4.36 (m, 24H,  $3\times\text{H}_{A4}$ ,  $1\times\text{H}_{A1}$ ,  $3\times\text{H}_{C1}$ ,  $3\times\text{H}_{B5}$ ,  $3\times\text{H}_{C5}$ ), 4.32 – 3.78 (m, 25H,  $3\times\text{H}_{A6}$ ,  $3\times\text{H}_{C4}$ ,  $3\times\text{H}_{B4}$ ,  $3\times\text{H}_{B2}$ ,  $3\times\text{H}_{B3}$ ,  $3\times\text{H}_{C5}$ ,  $3\times\text{H}_{A2}$ ,  $3\times\text{H}_{A3}$ ), 3.71

(d,  $J = 9.0$  Hz, 2H,  $2\times\text{H}_{A5}$ ), 3.66 – 3.54 (m, 2H,  $\text{H}_{A5}$ ), 3.47 (dt,  $J = 10.0, 6.7$  Hz, 1H), 3.19 (dd,  $J = 11.2, 3.9$  Hz,  $1\times\text{H}_{C2}$ ), 3.09 (dt,  $J = 10.3, 5.0$  Hz, 2H,  $2\times\text{H}_{C2}$ ), 2.78 (m, 1H), 2.68 (m, 1H), 2.56 (m, 1H), 2.43 (m, 1H), 2.29 (q,  $J = 7.0$  Hz, 2H), 2.15 (d,  $J = 11.7$  Hz, 3H), 1.05 (s, 9H), 1.03 (s, 9H), 1.02 (s, 9H), 0.88 (d,  $J = 7.3$  Hz, 3H,  $1\times\text{H}_{C6}$ ), 0.86 (s, 9H), 0.83 (d,  $J = 5.3$  Hz, 21H,  $1\times\text{H}_{C6}$ ), 0.76 (d,  $J = 6.4$  Hz, 3H,  $1\times\text{H}_{C6}$ ).  $^{13}\text{C}$  NMR (151 MHz,  $\text{CDCl}_3$ )  $\delta$  206.4, 171.9, 168.0, 167.9, 167.7, 156.9, 156.6, 138.3, 138.3, 138.3, 138.3, 138.2, 138.2, 136.4, 136.2, 135.2, 135.0, 134.9, 134.8, 128.8, 128.7, 128.7, 128.6, 128.6, 128.5, 128.5, 128.5, 128.5, 128.4, 128.4, 128.4, 128.3, 128.3, 128.3, 128.3, 128.2, 128.1, 128.1, 128.0, 127.9, 127.8, 127.8, 127.8, 127.7, 127.7, 127.7, 127.6, 127.6, 127.5, 127.4, 127.4, 116.7; 98.5, 98.4 and 98.0 ( $3\times\text{C}_{C1}$ ); 97.8 ( $1\times\text{C}_{A1}$ ), 93.1 ( $2\times\text{C}_{A1}$ ); 91.7, 91.6 and 91.5 ( $3\times\text{C}_{B1}$ ); 76.9, 76.8 and 76.8 ( $3\times\text{C}_{B4}$ ); 75.5, 75.4, 75.2, 75.0, 75.0 and 74.6 ( $3\times\text{C}_{B2}$ ,  $3\times\text{C}_{B3}$ ); 73.4, 73.3, 73.2, 73.1, 72.8; 72.8, 72.6 and 72.4 ( $1\times\text{C}_{A2}$ ,  $3\times\text{C}_{A3}$ ); 71.6, 71.5; 70.9, 70.7, 70.6, 70.4 and 70.4 ( $3\times\text{C}_{B5}$ ,  $2\times\text{C}_{A2}$ ,  $1\times\text{C}_{C3}$ ); 69.5, 69.4, 69.4 and 69.3 ( $3\times\text{C}_{A4}$ ,  $2\times\text{C}_{C3}$ ); 67.5, 67.4, 67.2, 67.2, 67.1, 67.0, 66.9; 67.1, 65.7 and 64.8 ( $3\times\text{C}_{C5}$ ); 60.0, 59.9 and 57.9 ( $3\times\text{C}_{C2}$ ); 52.7 and 50.6 ( $3\times\text{C}_{C4}$ ), 38.0, 33.9, 28.0, 27.9, 27.8, 27.3, 27.2, 27.2, 23.3, 23.30, 23.3, 20.6, 20.6, 16.3 ( $1\times\text{C}_{C6}$ ), 16.2 ( $1\times\text{C}_{C6}$ ), 16.1 ( $1\times\text{C}_{C6}$ ).  $[\alpha]_D^{20} = +120^\circ$  ( $c = 0.6$ ,  $\text{CHCl}_3$ ). IR (neat): 697, 735, 826, 976, 998, 1036, 1232, 1457, 1507, 1653, 1700, 1717, 2108, 2859, 2923. HR-MS:  $[\text{M}+2\text{H}^+]$  Calculated for  $\text{C}_{195}\text{H}_{236}\text{N}_{12}\text{O}_{48}\text{Si}_3$ : 1799.7924; found: 1799.7880.

**Nonasaccharide 48:** The title compound was obtained by the general procedure for delevulinoylation from

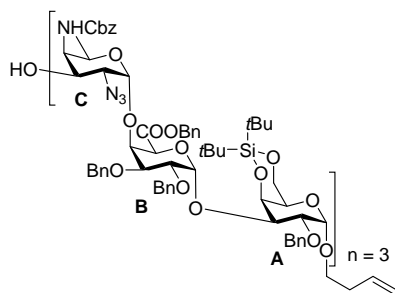

compound **47**. 317 mg, yield: 89%. *R<sub>f</sub>* = 0.4 (toluene/EtOAc, 3:1).

<sup>1</sup>H NMR (400 MHz, Chloroform-*d*) δ 7.44 – 7.13 (m, 75H), 5.84 – 5.68 (m, 1H), 5.65 – 5.49 (m, 3H, 3xH<sub>B1</sub>), 5.29 – 4.96 (m, 15H, 2xH<sub>A1</sub>), 4.89 (m, 5H), 4.81 – 4.43 (m, 25H, 3xH<sub>A4</sub>, 1xH<sub>A1</sub>, 3xH<sub>B5</sub>, 3xH<sub>C1</sub>), 4.41 – 3.79 (m, 23H, 3xH<sub>C5</sub>, 3xH<sub>A6</sub>, 3xH<sub>C4</sub>, 3xH<sub>B4</sub>, 3xH<sub>B2</sub>, 3xH<sub>B3</sub>, 3xH<sub>C5</sub>, 3xH<sub>A2</sub>, 3xH<sub>A3</sub>), 3.72 (d, *J* = 3.0 Hz, 2H, 2xH<sub>A5</sub>), 3.64 – 3.54 (m, 2H, 1xH<sub>A5</sub>), 3.47 (m, 1H), 3.12 (m, 2H, 2xH<sub>C2</sub>), 2.99 (dd, *J* = 10.6, 3.8 Hz, 1H, 1xH<sub>C2</sub>), 2.30 (m, 2H), 1.05 (s, 9H), 1.04 (s, 9H),

1.02 (s, 9H), 0.91 – 0.78 (m, 36H, 3xH<sub>C6</sub>). <sup>13</sup>C NMR (101 MHz, CDCl<sub>3</sub>) δ 167.9, 167.9, 167.6, 158.2, 156.8, 138.3, 138.3, 138.3, 138.2, 138.1, 136.2, 135.9, 135.1, 134.9, 134.8, 134.8, 128.8, 128.7, 128.7, 128.7, 128.6, 128.5, 128.4, 128.4, 128.4, 128.4, 128.3, 128.3, 128.3, 128.2, 128.2, 128.1, 128.1, 128.0, 128.0, 127.9, 127.8, 127.7, 127.7, 127.6, 127.6, 127.5, 127.5, 127.4, 127.4, 116.7; 98.5, 98.3, 98.0 and 97.8 (1xC<sub>A1</sub>, 3xC<sub>C1</sub>), 93.0 (2xC<sub>A1</sub>); 91.6, 91.5 and 91.3 (3xC<sub>B1</sub>); 76.8 and 76.4 (3xC<sub>B4</sub>); 75.7, 75.3, 74.9 and 74.5 (3xC<sub>B2</sub>, 3xC<sub>B3</sub>), 73.3, 73.3, 73.0, 72.7; 71.4, 71.4, 71.3; 72.5, 72.2, 70.8, 70.5, 70.4, 70.3, 70.3, 69.5, 69.5, 69.4, 69.3 and 68.8 (3xC<sub>B5</sub>, 3xC<sub>A2</sub>, 3xC<sub>A3</sub>, 3xC<sub>A4</sub>, 3xC<sub>C3</sub>); 67.5, 67.4, 67.3, 67.2, 67.2, 67.1, 67.0, 66.9, 66.9 (3xC<sub>A5</sub>, 3xC<sub>A6</sub>); 65.6 and 65.0 (3xC<sub>C5</sub>); 60.9, 60.0 and 59.9 (3xC<sub>C2</sub>); 55.9 and 50.5 (3xC<sub>C4</sub>), 33.8, 27.9, 27.9, 27.8, 27.3, 27.16, 27.1, 23.3, 23.3, 23.2, 20.6, 20.5, 16.3 (1xC<sub>C6</sub>), 16.2 (1xC<sub>C6</sub>), 16.2 (1xC<sub>C6</sub>). [α]<sub>D</sub><sup>20</sup> = +141° (c = 1.0, CHCl<sub>3</sub>). IR (neat): 696, 736, 799, 976, 993, 1028, 1097, 1419, 1457, 1507, 1560, 1653, 1700, 1717, 2106, 2857, 2924. HR-MS [M+2H<sup>+</sup>] Calculated for C<sub>190</sub>H<sub>230</sub>N<sub>12</sub>O<sub>46</sub>Si<sub>3</sub>: 1750.7740; found: 1750.7676.

**Dodecasaccharide 49:** The title compound was obtained by the general procedure of glycosylation reactions for

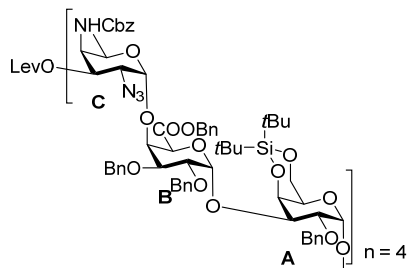

synthesis long oligosaccharides from trisaccharide donor **13** and

nonasaccharide acceptor **48**. 101 mg, yield: 72%. *R<sub>f</sub>* = 0.5

(toluene/EtOAc, 3:1). <sup>1</sup>H NMR (600 MHz, Chloroform-*d*) δ 7.47 – 7.10 (m, 100H), 5.74 (m, 1H), 5.60 – 5.50 (m, 4H, 4xH<sub>B1</sub>), 5.31 – 4.97 (m, 19H, 3xH<sub>A1</sub>, H<sub>C''3</sub>), 4.95 – 4.81 (m, 8H), 4.80 – 4.37 (m, 29H, 4xH<sub>A4</sub>, 1xH<sub>A1</sub>, 4xH<sub>C1</sub>, 4xH<sub>B5</sub>, 1xH<sub>C5</sub>), 4.32 – 3.78 (m, 29H, 4xH<sub>A6</sub>, 4xH<sub>C4</sub>, 4xH<sub>B4</sub>, 4xH<sub>B2</sub>, 4xH<sub>B3</sub>, 3xH<sub>C5</sub>, 4xH<sub>A2</sub>, 4xH<sub>A3</sub>), 3.75 – 3.65 (m, 3H, 3xH<sub>A5</sub>), 3.63 – 3.53 (m, 2H, 1xH<sub>A5</sub>), 3.47 (m, 1H),

3.19 (dd, *J* = 11.2, 3.9 Hz, 1H, 1xH<sub>C2</sub>), 3.14 – 3.02 (m, 3H, 3xH<sub>C2</sub>), 2.78 (m, 1H), 2.68 (m, 1H), 2.62 – 2.51 (m, 1H), 2.43 (m, 1H), 2.29 (m, 2H), 2.16 (s, 3H), 1.10 – 0.97 (m, 36H), 0.93 – 0.73 (m, 48H, 4xH<sub>C6</sub>). <sup>13</sup>C NMR (151 MHz, CDCl<sub>3</sub>) δ 206.5, 172.0, 168.0, 167.8, 156.9, 156.9, 156.6, 139.4, 138.4, 138.4, 138.3, 138.3, 138.3, 138.2, 138.2, 136.5, 136.3, 136.2, 135.9, 135.2, 135.0, 134.9, 134.9, 134.8, 129.1, 128.9, 128.9, 128.8, 128.8, 128.8, 128.8, 128.7, 128.7, 128.7, 128.7, 128.6, 128.6, 128.6, 128.5, 128.5, 128.5, 128.4, 128.4, 128.4, 128.3, 128.3,

## Chapter 7

128.3, 128.2, 128.2, 128.2, 128.1, 128.1, 128.0, 128.0, 128.0, 127.9, 127.9, 127.8, 127.8, 127.8, 127.7, 127.7, 127.7, 127.7, 127.7, 127.6, 127.6, 127.5, 127.5, 127.3, 125.4, 124.9, 116.8, 114.2; 98.5, 98.4, 98.0 and 97.9 (1xC<sub>A1</sub>, 4xC<sub>C1</sub>); 93.1 and 93.1 (3xC<sub>A1</sub>); 91.7, 91.6, 91.5 and 91.5 (1xC<sub>A1</sub>, 3xC<sub>C1</sub>); 77.0, 76.9, 76.8 and 76.7 (4xC<sub>B4</sub>); 75.5, 75.4, 75.4, 75.2, 75.0, 74.9 and 74.6 (4xC<sub>B2</sub>, 4xC<sub>B3</sub>); 73.5, 73.4, 73.4, 73.3, 73.2, 72.9, 72.8, 71.7, 71.5, 71.5 (Bn); 72.9, 72.6, 72.3, 70.8, 70.6, 70.5, 70.5, 70.4, 70.4, 69.7, 69.6, 69.5, 69.4 and 69.4 (4xC<sub>B5</sub>, 4xC<sub>A2</sub>, 4xC<sub>A3</sub>, 4xC<sub>A4</sub>, 4xC<sub>C3</sub>); 67.5, 67.5, 67.4, 67.4, 67.3, 67.2, 67.1, 67.0, 67.0 (4xC<sub>A6</sub>, Bn); 67.4, 67.3 and 67.1 (4xC<sub>A5</sub>); 65.7, 65.7, 65.6 and 64.9 (4xC<sub>C5</sub>); 60.1, 60.0 and 60.0 (4xC<sub>C2</sub>); 58.0, 52.7 and 50.6 (4xC<sub>C4</sub>); 38.1, 33.9, 32.0, 30.4, 29.8, 28.0, 28.0, 27.9, 27.9, 27.3, 27.2, 27.2, 23.4, 23.4, 23.4, 23.3, 22.8, 20.7, 20.6; 16.3 and 16.3 (4xC<sub>C6</sub>).  $[\alpha]_D^{20} = +141^\circ$  (c = 1.0, CHCl<sub>3</sub>). IR (neat): 668, 698, 799, 827, 1036, 1096, 1457, 1507, 1560, 1653, 1700, 1734, 2108, 2918. HR-MS:  $[M+2H]^+$  Calculated for C<sub>257</sub>H<sub>310</sub>N<sub>16</sub>O<sub>63</sub>Si<sub>4</sub>: 2371.0384; found: 2371.0382.

**Dodecasaccharide 50:** The title compound was obtained by the general procedure for delevulinoylation from

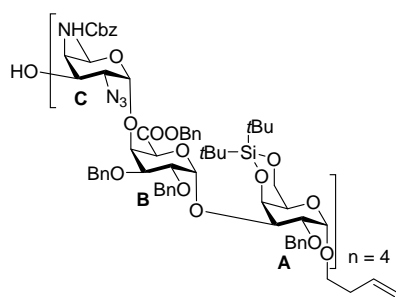

compound **49**. 358 mg, yield: 91%. *R<sub>f</sub>* = 0.4 (toluene/EtOAc, 3:1).

<sup>1</sup>H NMR (600 MHz, Chloroform-*d*)  $\delta$  7.43 – 7.09 (m, 100H), 5.74 (m, 1H), 5.61 – 5.48 (m, 4H, 4xH<sub>B1</sub>), 5.32 – 4.96 (m, 18H, 3xH<sub>A1</sub>), 4.95 – 4.81 (m, 7H), 4.79 – 4.42 (m, 28H, 4xH<sub>A4</sub>, 1xH<sub>A1</sub>, 4xH<sub>C1</sub>, 4xH<sub>B5</sub>), 4.40 – 3.78 (m, 29H, 4xH<sub>A6</sub>, 4xH<sub>C4</sub>, 4xH<sub>B4</sub>, 4xH<sub>B2</sub>, 4xH<sub>B3</sub>, 4xH<sub>C5</sub>, 4xH<sub>A2</sub>, 4xH<sub>A3</sub>), 3.70 (d, *J* = 7.5 Hz, 3H, 3xH<sub>A5</sub>), 3.64 – 3.53 (m, 2H, 1xH<sub>A5</sub>), 3.47 (m, 1H), 3.16 – 3.04 (m, 3H, 3xH<sub>C2</sub>), 2.96 (dd, *J* = 10.6, 3.8 Hz, 1H, 1xH<sub>C2</sub>), 2.34 – 2.23 (m, 2H), 1.03 (m, 36H), 0.93 –

0.71 (m, 48H, 4xH<sub>C6</sub>). <sup>13</sup>C NMR (151 MHz, CDCl<sub>3</sub>)  $\delta$  168.0, 167.8, 158.3, 156.9, 138.5, 138.4, 138.4, 138.4, 138.3, 138.3, 138.2, 136.3, 136.0, 135.2, 135.0, 135.0, 135.0, 134.9, 128.9, 128.8, 128.8, 128.8, 128.8, 128.7, 128.7, 128.7, 128.6, 128.5, 128.5, 128.5, 128.5, 128.4, 128.4, 128.4, 128.3, 128.3, 128.3, 128.2, 128.2, 128.1, 128.0, 128.0, 128.0, 127.9, 127.9, 127.8, 127.8, 127.8, 127.7, 127.7, 127.7, 127.7, 127.6, 127.6, 127.5, 127.5, 127.5, 116.8; 98.6, 98.5, 98.0, 98.0 and 97.9 (1xC<sub>A1</sub>, 4xC<sub>C1</sub>); 93.1 and 93.1 (3xC<sub>A1</sub>); 91.8, 91.7, 91.6 and 91.6 (4xC<sub>B1</sub>); 77.0, 76.9, 76.8 and 76.5 (4xC<sub>B4</sub>); 75.9, 75.6, 75.5, 75.1, 75.0, 75.0 and 74.6 (4xC<sub>B2</sub>, 4xC<sub>B3</sub>); 73.5, 73.4, 73.2, 73.2, 72.8, 72.8, 71.6, 71.5 (Bn); 72.9, 72.7, 72.4, 71.1, 70.8, 70.8, 70.5, 70.5, 70.4, 69.7, 69.6, 69.6, 69.5, 69.4, 69.4 and 69.1 (4xC<sub>B5</sub>, 4xC<sub>A2</sub>, 4xC<sub>A3</sub>, 4xC<sub>A4</sub>, 4xC<sub>C3</sub>); 67.6, 67.6, 67.5, 67.4, 67.4, 67.3, 67.3, 67.2; 67.0, 67.0 (4xC<sub>A6</sub> and Bn); 67.4 and 67.1 (4xC<sub>A5</sub>); 65.7, 65.7 and 65.1 (4xC<sub>C5</sub>); 61.1, 60.1 and 60.0 (4xC<sub>C2</sub>); 60.0 and 50.6 (4xC<sub>C4</sub>); 33.9, 28.0, 28.0, 28.0, 27.9, 27.3, 27.3, 23.4, 23.4, 23.4, 20.7, 20.7, 20.7, 16.4 and 16.3 (4xC<sub>C6</sub>).  $[\alpha]_D^{20} = +120^\circ$  (c = 1.0, CHCl<sub>3</sub>). IR (neat): 698, 738, 827, 976, 1028, 1099, 1457, 1507, 1560, 1653, 1684, 1700, 2918, 3675.



**Hexasaccharide 51:** The title compound was obtained by the general procedure for BOM protection from

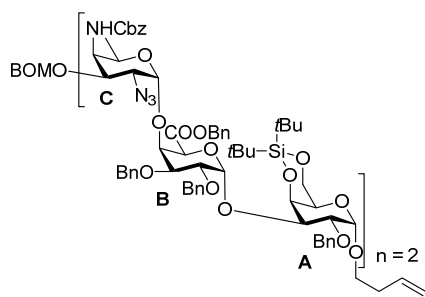

compound **46**. 101 mg, yield: 81%. *R*<sub>f</sub> = 0.43 (toluene/EtOAc, 5:1). <sup>1</sup>H NMR (500 MHz, Chloroform-*d*) δ 7.46 – 7.07 (m, 55H), 5.74 (m, 1H), 5.59 (d, *J* = 3.5 Hz, 1H, H<sub>B1</sub> or B'1), 5.53 (bs, 1H, H<sub>B1</sub> or B'1), 5.29 – 4.44 (m, 35H, 2xH<sub>C1</sub>, 2x H<sub>A1</sub>, 2xH<sub>B5</sub>, 2xH<sub>A4</sub>), 4.36 – 3.82 (m, 21H, 2xH<sub>B4</sub>, 2xH<sub>C5</sub>, 2xH<sub>C4</sub>, 2xH<sub>C3</sub>, 2xH<sub>A2</sub>, 2xH<sub>A3</sub>, 2xH<sub>B2</sub>, 2xH<sub>B3</sub>, 2xH<sub>A6</sub>), 3.72 (s, 1H, 1xH<sub>A5</sub>), 3.63 – 3.54 (m, 2H, 1xH<sub>A5</sub>), 3.47 (m, 1H), 3.12 (dd, *J* = 10.9, 4.0 Hz, 1H, 1xH<sub>C2</sub>), 3.02 (dd, *J* = 10.8, 4.0 Hz, 1H, 1xH<sub>C2</sub>), 2.29 (q, *J* = 6.9 Hz, 2H), 1.03 (s, 9H),

1.01 (s, 9H), 0.91 – 0.78 (m, 24H, 2xH<sub>C6</sub>). <sup>13</sup>C NMR (126 MHz, CDCl<sub>3</sub>) δ 168.0, 167.9, 156.9, 156.9, 138.4, 138.3, 138.3, 138.2, 137.8, 136.4, 136.3, 135.2, 134.9, 128.9, 128.8, 128.8, 128.7, 128.7, 128.6, 128.5, 128.5, 128.4, 128.4, 128.3, 128.2, 128.2, 128.0, 128.0, 127.8, 127.8, 127.7, 127.7, 127.6, 127.5, 116.8; 98.5, 98.4 and 97.9 (1xC<sub>A1</sub> and 2xC<sub>C1</sub>); 93.1 (1xC<sub>A1</sub>); 92.5; 91.8 and 91.7 (2xC<sub>B1</sub>); 77.0 and 76.5 (2xC<sub>B4</sub>); 75.6, 75.1, 75.0 and 74.6 (2xC<sub>B2</sub> and 2xC<sub>B3</sub>); 73.4, 73.2, 73.1 and 72.8 (Bn); 72.8, 72.7, 72.4 and 71.8 (2xC<sub>A2</sub> and 2xC<sub>A3</sub>); 71.6 and 70.0 (Bn); 71.6, 70.8, 70.4, 70.4, 70.0, 69.5, 69.4 and 69.3 (2xC<sub>A4</sub>, 2xC<sub>B5</sub> and 2xC<sub>C3</sub>); 67.5, 67.4, 67.4, 67.3, 67.2, 67.1, 67.0 and 67.0 (Bn, 2xC<sub>A5</sub> and 2xC<sub>A6</sub>); 65.7 and 65.4 (2xC<sub>C5</sub>); 59.9 and 59.8 (2xC<sub>C2</sub>), 52.9 and 50.6 (2xC<sub>C4</sub>); 41.0, 33.9, 28.0, 27.9, 27.3, 24.0, 23.3, 20.6, 20.6, 16.4 and 16.3 (2xC<sub>C6</sub>). [α]<sup>20</sup><sub>D</sub> = +125° (c = 1.0, CHCl<sub>3</sub>). IR (neat): 651, 697, 733, 799, 825, 862, 907, 913, 917, 976, 996, 1027, 1035, 1093, 1263, 1387, 1457, 1507, 1653, 1700, 2108, 2853, 2932. HR-MS [M+H]<sup>+</sup> Calculated for C<sub>133</sub>H<sub>162</sub>N<sub>8</sub>O<sub>33</sub>Si<sub>2</sub>: 2478.1063; found: 2478.0825.

**Nonasaccharide 52:** The title compound was obtained by the general procedure for BOM protection from

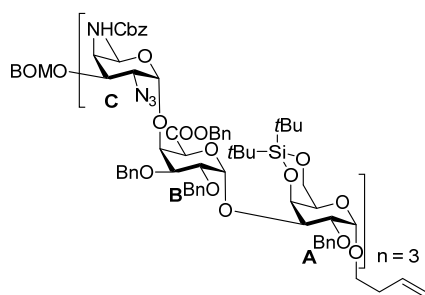

compound **48**. 147 mg, yield: 89%. *R*<sub>f</sub> = 0.4 (toluene/EtOAc, 4:1). <sup>1</sup>H NMR (500 MHz, Chloroform-*d*) δ 7.44 – 7.08 (m, 80H), 5.74 (m, 1H), 5.62 – 5.49 (m, 3H, 3xH<sub>B1</sub>), 5.29 – 4.93 (m, 13H, 2xH<sub>A1</sub>), 4.92 – 4.41 (m, 31H, 3xH<sub>C1</sub>, 1xH<sub>A1</sub>, 3xH<sub>B5</sub>, 3xH<sub>A4</sub>), 4.36 – 3.80 (m, 31H, 3xH<sub>B4</sub>, 3xH<sub>C5</sub>, 3xH<sub>C4</sub>, 3xH<sub>C3</sub>, 3xH<sub>A2</sub>, 3xH<sub>A3</sub>, 3xH<sub>B2</sub>, 3xH<sub>B3</sub>, 3xH<sub>A6</sub>), 3.70 (d, *J* = 2.3 Hz, 2H, 2xH<sub>A5</sub>), 3.64 – 3.53 (m, 2H, 1xH<sub>A5</sub>), 3.47 (m, 1H), 3.11 (dt, *J* = 10.9, 3.9 Hz, 2H, 2xH<sub>C2</sub>), 3.01 (dd, *J* = 10.8, 3.9 Hz, 1H, 1xH<sub>C2</sub>), 2.29 (q, *J* = 6.9 Hz, 2H), 1.04 (s,

9H), 1.02 (s, 9H), 1.01 (s, 9H), 0.90 – 0.77 (m, 36H, 3xH<sub>C6</sub>). <sup>13</sup>C NMR (126 MHz, CDCl<sub>3</sub>) δ 168.0, 167.9, 167.8, 156.9, 156.9, 138.4, 138.4, 138.4, 138.3, 138.2, 137.8, 136.5, 136.3, 136.3, 135.2, 135.0, 134.9, 134.9, 129.0, 128.9, 128.8, 128.8, 128.8, 128.7, 128.7, 128.7, 128.6, 128.6, 128.5, 128.5, 128.5, 128.4, 128.4, 128.4, 128.3, 128.3, 128.2, 128.2, 128.2, 128.1, 128.1, 128.0, 127.9, 127.9, 127.8, 127.8, 127.8, 127.8, 127.7, 127.7, 127.6, 127.5, 127.5, 116.8; 98.5, 98.3, 98.1 and 97.9 (1xC<sub>A1</sub> and 3xC<sub>C1</sub>); 93.1 (2xC<sub>A1</sub>), 92.5 (BOM), 91.7, 91.5 and 91.4 (3xC<sub>B1</sub>); 77.0 and 76.5 (3xC<sub>B4</sub>); 75.6, 75.4, 75.2, 75.0, 74.9 and 74.6 (3xC<sub>B2</sub> and 3xC<sub>B3</sub>), 73.5, 73.4, 73.3, 73.2, 72.9 (Bn); 72.8,

## Chapter 7

72.6, 72.3, 71.9 (3xC<sub>A2</sub> and 3xC<sub>A3</sub>); 71.5, 71.5, 70.0 (Bn); 70.7, 70.5, 70.4, 69.6, 69.4, 69.4 (3xC<sub>A4</sub>, 3xC<sub>B5</sub> and 3xC<sub>C3</sub>); 67.5, 67.5, 67.3, 67.2, 67.1, 67.1, 67.0, 67.0 (Bn, 3xC<sub>A5</sub> and 3xC<sub>A6</sub>); 65.7 and 65.4 (3xC<sub>C5</sub>); 60.1, 60.0 and 59.8 (2xC<sub>C2</sub>); 53.9, 52.9 and 50.6 (3xC<sub>C4</sub>); 33.9, 28.0, 28.0, 27.9, 27.3, 27.2, 23.4, 23.4, 20.7, 20.6; 16.4, 16.3 and 16.3 (3xC<sub>C6</sub>).  $[\alpha]^{20}_D = +135^\circ$  ( $c = 0.84$ , CHCl<sub>3</sub>). IR (neat): 698, 741, 799, 827, 1037, 1101, 1457, 1507, 1560, 1653, 1700, 1717, 1734, 2108, 2875, 2924, 3675.

**Dodecasaccharide 53:** The title compound was obtained by the general procedure for BOM protection from

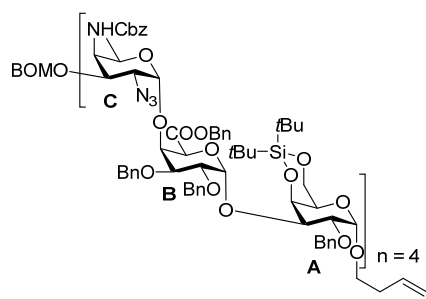

compound **50**. 43 mg, yield: 84%.  $R_f = 0.31$  (toluene/EtOAc, 4:1). <sup>1</sup>H NMR (600 MHz, Chloroform-*d*)  $\delta$  7.44 – 7.09 (m, 105H), 5.73 (m, 1H), 5.61 – 5.49 (m, 4H, 4xH<sub>B1</sub>), 5.32 – 4.93 (m, 19H, 3xH<sub>A1</sub>), 4.92 – 4.38 (m, 41H, 4xH<sub>C1</sub>, 1xH<sub>A1</sub>, 4xH<sub>B5</sub>, 4xH<sub>A4</sub>), 4.36 – 3.76 (m, 40H, 4xH<sub>B4</sub>, 4xH<sub>C5</sub>, 4xH<sub>C4</sub>, 4xH<sub>C3</sub>, 4xH<sub>A2</sub>, 4xH<sub>A3</sub>, 4xH<sub>B2</sub>, 4xH<sub>B3</sub>, 4xH<sub>A6</sub>), 3.69 (d,  $J = 6.1$  Hz, 3H, 3xH<sub>A5</sub>), 3.60 – 3.54 (m, 2H, 1xH<sub>A5</sub>), 3.46 (m, 1H), 3.10 (ddq,  $J = 12.8, 9.4, 4.0$  Hz, 3H, 3xH<sub>C2</sub>), 3.00 (dd,  $J = 10.8, 3.9$  Hz, 1H, 1xH<sub>C2</sub>), 2.28 (q,  $J =$

7.0 Hz, 2H), 1.10 – 0.95 (m, 36H), 0.93 – 0.75 (m, 48H, 4xH<sub>C6</sub>). <sup>13</sup>C NMR (151 MHz, CDCl<sub>3</sub>)  $\delta$  168.0, 167.8, 167.8, 157.0, 156.9, 156.9, 138.4, 138.4, 138.4, 138.3, 138.3, 138.2, 137.8, 136.5, 136.3, 136.3, 135.2, 135.0, 134.9, 134.9, 134.8, 129.0, 128.9, 128.9, 128.8, 128.8, 128.8, 128.7, 128.7, 128.7, 128.6, 128.6, 128.5, 128.5, 128.5, 128.5, 128.4, 128.4, 128.3, 128.3, 128.3, 128.3, 128.2, 128.2, 128.2, 128.1, 128.1, 128.1, 128.1, 128.0, 128.0, 127.9, 127.9, 127.9, 127.8, 127.8, 127.8, 127.8, 127.7, 127.7, 127.7, 127.7, 127.6, 127.6, 127.51, 127.5, 116.84; 98.5, 98.33, 98.0, 97.9 and 97.9 (1xC<sub>A1</sub> and 4xC<sub>C1</sub>); 93.1 (3xC<sub>A1</sub>); 92.5 (BOM), 91.7, 91.6, 91.5 and 91.5 (4xC<sub>B1</sub>); 77.1, 76.8 and 76.5 (4xC<sub>B4</sub>); 75.6, 75.4, 75.4, 75.1, 75.0, 74.9 and 74.6 (4xC<sub>B2</sub> and 4xC<sub>B3</sub>); 73.5, 73.5, 73.3, 73.2, 72.9, 72.9 (Bn); 72.6, 72.3, 71.8 (4xC<sub>A2</sub> and 4xC<sub>A3</sub>); 71.6, 71.5, 70.0 (Bn); 70.8, 70.6, 70.5, 70.5, 70.4, 69.7, 69.7, 69.4, 69.4, 69.4 (4xC<sub>A4</sub>, 4xC<sub>B5</sub> and 4xC<sub>C3</sub>); 67.5, 67.5, 67.4, 67.3, 67.2, 67.1, 67.1, 67.0, 67.0 (Bn, 4xC<sub>A5</sub> and 4xC<sub>A6</sub>); 65.7, 65.7, 65.7, 65.4 (4xC<sub>C5</sub>); 60.1, 60.1, 60.0 and 59.8 (4xC<sub>C5</sub>); 52.9 and 50.6 (4xC<sub>C5</sub>); 33.9, 28.1, 28.0, 28.0, 27.99, 27.9, 27.3, 27.3, 27.2, 23.4, 23.4, 23.4, 23.4, 20.7, 20.6; 16.3 (4xC<sub>C6</sub>).  $[\alpha]^{20}_D = +128^\circ$  ( $c = 1.0$ , CHCl<sub>3</sub>). IR (neat): 651, 696, 734, 799, 826, 976, 996, 1028, 1034, 1095, 1260, 1457, 1507, 1653, 1700, 1717, 2108, 2857, 2930, 3675. HR-MS  $[M+2H]^+$  Calculated for C<sub>260</sub>H<sub>312</sub>N<sub>16</sub>O<sub>62</sub>Si<sub>4</sub>: 2382.0488; found: 2382.0444.

**Hexasaccharide 54:** The title compound was obtained by the general procedure for transferred azide into

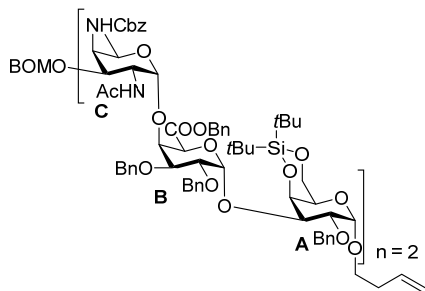

acetylamino reactions for long oligosaccharides from compound **51**. 113 mg, yield: 93%. *R<sub>f</sub>* = 0.75 (DCM/MeOH, 20:1). <sup>1</sup>H NMR (500 MHz, Chloroform-*d*) δ 7.43 – 7.04 (m, 55H), 5.83 – 5.67 (m, 2H), 5.57 (d, *J* = 3.3 Hz, 1H, 1xH<sub>B1</sub>), 5.46 (d, *J* = 3.2 Hz, 1H, 1xH<sub>B1</sub>), 5.21 (d, *J* = 11.6 Hz, 1H), 5.17 – 4.83 (m, 14H, 1xH<sub>A1</sub>), 4.75 – 4.37 (m, 23H, 2xH<sub>C1</sub>, 1xH<sub>A1</sub>, 2xH<sub>B5</sub>, 2xH<sub>A4</sub>), 4.25 (m, 1H, 1xH<sub>C5</sub>), 4.22 – 3.82 (m, 20H, 2xH<sub>B4</sub>, 1xH<sub>C5</sub>, 2xH<sub>C4</sub>, 2xH<sub>A2</sub>, 2xH<sub>A3</sub>, 2xH<sub>B2</sub>, 2xH<sub>B3</sub>, 2xH<sub>A6</sub>), 3.77 (dd, *J* = 11.3,

4.2 Hz, 1H, 1xH<sub>C3</sub>), 3.65 – 3.56 (m, 3H, 1xH<sub>C3</sub>, 1xH<sub>A5</sub>), 3.54 – 3.43 (m, 2H, 1xH<sub>A5</sub>), 2.35 – 2.25 (m, 2H), 2.11 (s, 3H), 2.01 (s, 3H), 1.04 (s, 9H), 1.03 (s, 9H), 0.89 (s, 9H), 0.89 – 0.87 (m, 3H, 1xH<sub>C6</sub>), 0.85 (s, 9H), 0.76 (d, *J* = 6.2 Hz, 3H, 1xH<sub>C6</sub>). <sup>13</sup>C NMR (126 MHz, CDCl<sub>3</sub>) δ 170.8, 170.4, 168.9, 168.6, 157.1, 138.5, 138.3, 138.2, 138.1, 138.1, 137.9, 136.7, 136.6, 135.0, 134.8, 134.1, 129.3, 129.1, 129.1, 129.0, 129.0, 128.8, 128.7, 128.6, 128.5, 128.5, 128.5, 128.4, 128.4, 128.3, 128.3, 128.3, 128.1, 128.1, 128.1, 128.0, 128.0, 127.9, 127.9, 127.9, 127.8, 127.8, 127.7, 127.6, 127.6, 127.5, 116.8; 100.1 and 99.9 (2xC<sub>C1</sub>); 97.7 and 92.8 (2xC<sub>A1</sub>); 92.6 (BOM), 92.9 and 91.3 (2xC<sub>B1</sub>); 77.6 (2xC<sub>B4</sub>); 73.3, 73.2, 73.1, 72.0, 71.5, 69.6 (Bn); 75.9, 75.1, 74.4, 74.0, 72.8, 72.6, 72.3, 71.4, 70.6, 69.7, 69.2 (3xC<sub>B2</sub>, 3xC<sub>B3</sub>, 2xC<sub>A4</sub>, 2xC<sub>B5</sub> and 2xC<sub>C3</sub>, 2xC<sub>A2</sub> and 2xC<sub>A3</sub>); 67.7, 67.6, 67.3, 67.2, 67.2, 67.0, 66.6 (Bn, 2xC<sub>A5</sub> and 2xC<sub>A6</sub>); 66.5, 66.0 (2xC<sub>C5</sub>); 53.0 and 51.4 (2xC<sub>C4</sub>); 48.7 and 48.5 (2xC<sub>C2</sub>); 34.0, 28.0, 27.8, 27.4, 27.3, 27.3, 23.8, 23.4, 23.4, 20.7; 16.5 and 16.4 (2xC<sub>C6</sub>). [α]<sub>D</sub><sup>20</sup> = +113° (c = 1.0, CHCl<sub>3</sub>). IR (neat): 695, 741, 829, 1038, 1103, 1419, 1457, 1507, 1558, 1653, 1700, 1718, 1734, 2930, 3675.

**Hexasaccharide 10:** The title compound was obtained by the general procedure for deprotecting of the di-*tert*-

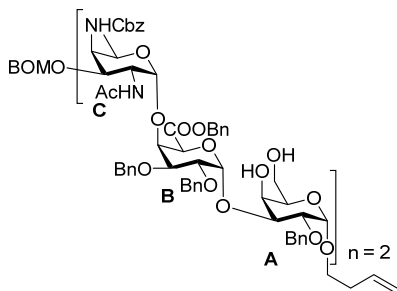

butyl silylidene ketal from compound **54**. 87 mg, yield: 91%. *R<sub>f</sub>* = 0.3 (DCM/MeOH, 20:1). <sup>1</sup>H NMR (500 MHz, Chloroform-*d*) δ 7.43 – 7.09 (m, 52H), 7.04 – 6.92 (m, 3H), 5.98 (d, *J* = 9.1 Hz, 1H, N-H), 5.85 – 5.72 (m, 1H), 5.69 (d, *J* = 9.5 Hz, 1H, N-H), 5.28 (d, *J* = 3.7 Hz, 1H, 1xH<sub>B1</sub>), 5.20 – 4.39 (m, 31H, 1xH<sub>B1</sub>, 2xH<sub>A1</sub>, 1xH<sub>B5</sub>, 2xH<sub>C1</sub>), 4.33 – 3.56 (m, 23H, 1xH<sub>B5</sub>, 2xH<sub>B4</sub>, 2xH<sub>C5</sub>, 2xH<sub>C4</sub>, 2xH<sub>C2</sub>, 2xH<sub>A2</sub>, 2xH<sub>A3</sub>, 2xH<sub>B2</sub>, 2xH<sub>B3</sub>, 2xH<sub>A6</sub>, 2xH<sub>A4</sub>, 2xH<sub>A5</sub>), 3.47 (m, 1H), 2.35 (q, *J* = 6.8 Hz, 2H), 2.10 (s, 3H), 2.06 (s, 3H), 0.84 (dd, *J* = 6.3, 3.5 Hz, 6H,

2xH<sub>C6</sub>). <sup>13</sup>C NMR (126 MHz, CDCl<sub>3</sub>) δ 170.9, 170.8, 168.1, 168.0, 157.1, 157.0, 138.5, 138.2, 138.0, 137.8, 137.8, 137.3, 137.0, 136.5, 136.5, 134.9, 134.4, 134.3, 129.1, 129.0, 129.0, 128.9, 128.9, 128.9, 128.8, 128.7, 128.6, 128.6, 128.6, 128.5, 128.5, 128.3, 128.2, 128.1, 128.1, 128.0, 128.0, 127.9, 127.9, 127.8, 127.8, 127.7, 127.7, 127.5, 116.9, 116.9; 99.9 and 99.2 (2xC<sub>C1</sub>); 96.9 (1xC<sub>A1</sub>), 94.4 and 94.3 (1xC<sub>A1</sub>, 1xC<sub>B1</sub>), 92.6 (1xC<sub>B1</sub>); 77.1 and 76.4 (2xC<sub>B4</sub>, 2xC<sub>B3</sub>); 74.8, 74.6, 74.3, 74.2, 72.4 (2xC<sub>B2</sub>, 2xC<sub>A2</sub>, 2xC<sub>A3</sub>); 74.7, 73.0, 72.6, 72.1 (Bn); 70.8 (Bn), 70.7, 69.9,

## Chapter 7

69.6 (2xC<sub>B5</sub>, 2xC<sub>C3</sub>); 68.6 (Bn), 67.7, 67.6, 67.0, 66.6 (Bn); 67.4, 66.8, 66.7, 66.6 (2xC<sub>A4</sub>, 2xC<sub>A5</sub>), 66.1 (2xC<sub>C5</sub>); 63.5, 63.3 (2xC<sub>A6</sub>); 53.9, 52.9 (2xC<sub>C4</sub>); 51.2, 48.5 (2xC<sub>C2</sub>); 33.9, 29.4, 23.8, 23.7; 16.6, 16.5 (2xC<sub>C6</sub>). [ $\alpha$ ]<sup>20</sup><sub>D</sub> = +160° (c = 1.0, CHCl<sub>3</sub>). IR (neat): 698, 735, 1028, 1040, 1094, 1457, 1507, 1558, 1653, 1717, 2930, 3675. HR-MS [M+H]<sup>+</sup> Calculated for C<sub>124</sub>H<sub>140</sub>N<sub>4</sub>O<sub>34</sub>: 2229.9422; found: 2229.9382.

**Nonasaccharide 55:** The title compound was obtained by general procedure for transferred azide into acetylamino

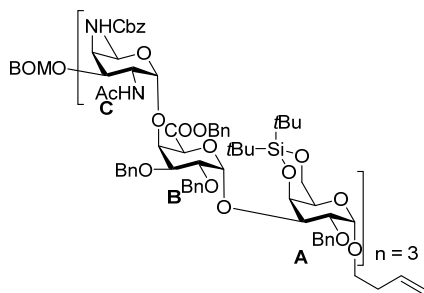

reactions for long oligosaccharides from compound **52**. 40 mg, yield: 88%. *R<sub>f</sub>* = 0.25 (DCM/MeOH, 30:1). <sup>1</sup>H NMR (500 MHz, Chloroform-*d*) δ 7.45 – 7.00 (m, 55H), 5.80 (d, *J* = 9.5 Hz, 1H, N-H), 5.78 – 5.70 (m, 1H), 5.65 (d, *J* = 9.5 Hz, 1H, N-H), 5.56 (d, *J* = 3.4 Hz, 1H, 1xH<sub>B1</sub>), 5.52 (d, *J* = 2.7 Hz, 1H, 1xH<sub>B1</sub>), 5.45 (d, *J* = 3.3 Hz, 1H, 1xH<sub>B1</sub>), 5.29 – 4.78 (m, 21H, 2xH<sub>A1</sub>), 4.76 – 4.32 (m, 32H, 3xH<sub>C1</sub>, 1xH<sub>A1</sub>, 3xH<sub>B5</sub>, 3xH<sub>A4</sub>), 4.28 – 3.36 (m, 43H, 3xH<sub>B4</sub>, 3xH<sub>C5</sub>, 3xH<sub>C4</sub>, 3xH<sub>C2</sub>, 3xH<sub>A2</sub>, 3xH<sub>A3</sub>, 3xH<sub>B2</sub>, 3xH<sub>B3</sub>, 3xH<sub>A6</sub>,

3xH<sub>A5</sub>), 2.30 (q, *J* = 6.8 Hz, 2H), 2.11 (s, 3H), 2.06 (s, 3H), 2.02 (s, 3H), 1.03 (d, *J* = 4.1 Hz, 27H), 0.89 (s, 9H), 0.86 (s, 9H), 0.83 (s, 9H), 0.75 (dd, *J* = 6.2, 3.3 Hz, 6H, 3xH<sub>C6</sub>). <sup>13</sup>C NMR (126 MHz, CDCl<sub>3</sub>) δ 170.9, 170.6, 170.3, 169.2, 168.7, 157.1, 157.0, 138.5, 138.3, 138.2, 138.1, 138.0, 137.9, 136.8, 136.6, 136.5, 135.0, 134.7, 134.5, 134.0, 129.3, 129.2, 129.1, 129.0, 128.9, 128.8, 128.7, 128.6, 128.6, 128.5, 128.5, 128.5, 128.4, 128.4, 128.4, 128.3, 128.3, 128.3, 128.1, 128.1, 128.0, 128.0, 127.9, 127.9, 127.9, 127.9, 127.8, 127.7, 127.7, 127.6, 127.6, 127.6, 127.5, 127.4, 116.9; 100.5, 100.1, 100.0 (3xC<sub>C1</sub>); 97.7, 94.7, 94.2 (3xC<sub>A1</sub>); 92.7 (BOM); 92.6, 91.3, 91.2 (3xC<sub>B1</sub>); 78.2, 77.7 (3xC<sub>B4</sub>); 75.8, 75.7, 74.4, 74.1, 73.9; (3xC<sub>B2</sub>, 3xC<sub>B3</sub>, 3xC<sub>A2</sub>, 3xC<sub>A3</sub>) 73.3, 73.2, 72.8, 73.1, 72.7 (Bn); 72.6, 72.2, 71.9, 71.6, 71.5, 71.4, 70.8, 70.6, 69.6, 69.5, 69.1, 69.0 (Bn, 3xC<sub>A4</sub>, 3xC<sub>B5</sub> and 3xC<sub>C3</sub>); 68.0, 67.8, 67.5, 67.3, 67.2, 67.1, 67.0, 66.6, 66.5, 66.4, 66.0 (Bn, 3xC<sub>C5</sub>, 3xC<sub>A5</sub> and 3xC<sub>A6</sub>); 53.0, 51.6, 51.2 (3xC<sub>C4</sub>); 48.7, 48.4 (3xC<sub>C2</sub>); 34.0, 28.0, 27.8, 27.3, 27.3, 27.3, 23.8, 23.6, 23.5, 23.4, 20.7; 16.5, 16.4, 16.4 (3xC<sub>C6</sub>). [ $\alpha$ ]<sup>20</sup><sub>D</sub> = +118° (c = 0.8, CHCl<sub>3</sub>). IR (neat): 650, 698, 734, 798, 825, 977, 999, 1038, 1098, 1244, 1362, 1456, 1497, 1668, 1717, 1757, 2857, 2928. HR-MS [M+2H]<sup>+</sup> Calculated for C<sub>204</sub>H<sub>250</sub>N<sub>6</sub>O<sub>56</sub>Si<sub>3</sub>: 1834.8329; found: 1834.8264.

**Nonasaccharide 11:** The title compound was obtained by the general procedure for deprotecting of the di-*tert*-

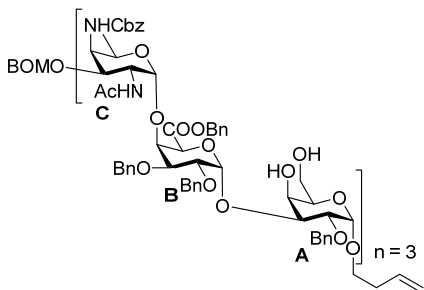

butyl silylidene ketal from compound **55**. 31 mg, yield: 88%. *R<sub>f</sub>* = 0.47 (DCM/MeOH, 15:1). <sup>1</sup>H NMR (600 MHz, Chloroform-*d*) δ 7.48 – 6.93 (m, 80H), 6.22 (d, *J* = 9.3 Hz, 1H, N-H), 6.05 (d, *J* = 9.4 Hz, 1H, N-H), 5.78 (m, 1H), 5.70 (d, *J* = 9.6 Hz, 1H, N-H), 5.29 (dd, *J* = 12.3, 3.9 Hz, 2H, 2xH<sub>B1</sub>), 5.17 – 4.35 (m, 42H, 1xH<sub>B1</sub>, 3xH<sub>A1</sub>, 1xH<sub>B5</sub>, 3xH<sub>C1</sub>), 4.34 – 3.43 (m, 39H, 2xH<sub>B5</sub>, 3xH<sub>B4</sub>, 3xH<sub>C5</sub>, 3xH<sub>C4</sub>, 3xH<sub>C2</sub>, 3xH<sub>A2</sub>, 3xH<sub>A3</sub>, 3xH<sub>B2</sub>, 3xH<sub>B3</sub>, 3xH<sub>A6</sub>, 3xH<sub>A4</sub>,

3xH<sub>A5</sub>), 2.40 – 2.32 (m, 2H), 2.15 – 2.02 (m, 9H, 3xCH<sub>3</sub>CONH-), 0.83 (dd, *J* = 11.2, 6.3 Hz, 6H, 2xH<sub>C6</sub>), 0.74 (d, *J* = 6.2 Hz, 3H, 1xH<sub>C6</sub>). <sup>13</sup>C NMR (151 MHz, CDCl<sub>3</sub>) δ 170.9, 170.9, 168.2, 168.0, 157.1, 157.0, 138.6, 138.5, 138.1, 138.0, 137.9, 137.8, 137.7, 137.2, 137.1, 136.9, 136.5, 136.4, 134.9, 134.3, 134.3, 134.1, 129.2, 129.1, 129.1, 129.0, 128.9, 128.9, 128.9, 128.9, 128.8, 128.8, 128.7, 128.6, 128.6, 128.6, 128.6, 128.6, 128.5, 128.5, 128.4, 128.3, 128.3, 128.2, 128.1, 128.1, 128.0, 128.0, 127.9, 127.9, 127.9, 127.9, 127.7, 127.7, 127.6, 127.6, 127.5, 127.4, 127.4, 127.3, 117.0; 100.0, 99.3, 99.2 (3xC<sub>C1</sub>); 96.8, 95.1, 94.4, 94.2, 92.8 (3xC<sub>A1</sub>, 3xC<sub>B1</sub>); 92.5 (BOM), 76.6, 76.3, 76.2, 76.2, 75.6, 75.0, 74.8, 74.7, 74.7, 74.4, 74.1, 74.0, 74.0 (Bn, 3xC<sub>B4</sub>, 3xC<sub>B3</sub>, 3xC<sub>B2</sub>, 3xC<sub>A2</sub>, 3xC<sub>A3</sub>); 73.0, 73.0, 72.8, 72.6, 71.9, 71.8 (Bn); 72.3, 70.8, 70.7, 70.2, 69.9 (3xC<sub>B5</sub>, 3xC<sub>C3</sub>); 69.6, 68.5, 67.7, 67.6, 67.4, 67.2, 67.0, 66.7, 66.6, 66.5, 66.5, 66.1 (Bn, 3xC<sub>A4</sub>, 3xC<sub>A5</sub>, 3xC<sub>C5</sub>); 63.4, 63.0 (3xC<sub>A6</sub>); 52.8, 51.1, 51.0 (3xC<sub>C4</sub>); 48.5 (3xC<sub>C2</sub>); 33.9, 23.8, 23.6, 23.6; 16.5, 16.5, 16.4 (3xC<sub>C6</sub>). IR (neat): 613, 698, 737, 1030, 1098, 1456, 1506, 1558, 1717, 1749, 2313, 2849, 2916.

**Dodecaasaccharide 56:** The title compound was obtained by the general procedure for transferred azide into

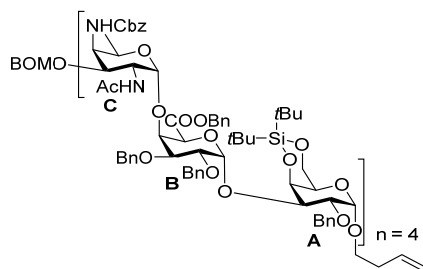

acetylamino reactions for long oligosaccharides from compound **53**. 199 mg, yield: 99%. *R<sub>f</sub>* = 0.71 (DCM/MeOH, 20:1). <sup>1</sup>H NMR (600 MHz, Chloroform-*d*) δ 7.43 – 6.99 (m, 105H), 5.80 (d, *J* = 9.5 Hz, 1H, N-H), 5.78 – 5.71 (m, 1H), 5.69 (m, 2H, N-H), 5.56 (d, *J* = 3.4 Hz, 1H, 1xH<sub>B1</sub>), 5.51 (s, 2H, 2xH<sub>B1</sub>), 5.44 (d, *J* = 3.3 Hz, 1H, 1xH<sub>B1</sub>), 5.40 – 5.31 (m, 3H, N-H), 5.20 – 4.80 (m, 26H, 3xH<sub>A1</sub>), 4.74 – 4.32 (m, 43H, 4xH<sub>C1</sub>, 1xH<sub>A1</sub>, 4xH<sub>B5</sub>,

4xH<sub>A4</sub>), 4.28 – 3.42 (m, 56H, 4xH<sub>B4</sub>, 4xH<sub>C5</sub>, 4xH<sub>C4</sub>, 4xH<sub>C2</sub>, 4xH<sub>A2</sub>, 4xH<sub>A3</sub>, 4xH<sub>B2</sub>, 4xH<sub>B3</sub>, 4xH<sub>A6</sub>, 4xH<sub>A5</sub>), 2.30 (q, *J* = 6.9 Hz, 2H), 2.08 (s, 3H), 2.05 (s, 3H), 2.04 (s, 3H), 2.01 (s, 3H), 1.06 – 1.00 (m, 36H), 0.90 (s, 9H), 0.86 (s, 12H, 1xH<sub>C6</sub>), 0.84 (s, 9H), 0.82 (s, 9H), 0.75 (d, *J* = 6.2 Hz, 9H, 3xH<sub>C6</sub>). <sup>13</sup>C NMR (151 MHz, CDCl<sub>3</sub>) δ 170.8, 170.6, 170.4, 169.3, 169.0, 168.7, 157.1, 157.1, 138.4, 138.4, 138.3, 138.3, 138.2, 138.1, 138.1, 138.1, 138.0, 137.9, 136.9, 136.8, 136.7, 136.6, 135.0, 134.7, 134.5, 134.5, 134.0, 129.3, 129.2, 129.2, 129.1, 129.0, 129.0, 128.9, 128.9, 128.8, 128.7, 128.6, 128.6, 128.6, 128.5, 128.5, 128.5, 128.5, 128.5, 128.4, 128.4, 128.3, 128.3, 128.3, 128.1, 128.1, 128.1, 128.1, 128.0, 128.0, 127.9, 127.9, 127.9, 127.9, 127.8, 127.7, 127.7, 127.7, 127.6, 127.6, 127.6, 116.8; 100.5, 100.1, 99.9 (4xC<sub>C1</sub>); 97.7, 95.0, 94.6 (4xC<sub>A1</sub>); 92.7 (BOM), 92.9, 91.4, 91.3, 91.2 (4xC<sub>B1</sub>); 78.2, 77.7 (4xC<sub>B4</sub>); 75.9, 75.8, 75.1, 74.4, 74.1, 74.1, 73.9, 73.4, 73.3, 73.2, 73.2, 73.1, 72.9, 72.9, 72.9, 72.8, 72.6, 72.2, 72.0, 71.6, 71.5, 71.5, 71.4, 70.8, 70.6, 69.7, 69.6, 69.1, 69.1 (Bn, 4xC<sub>B2</sub>, 4xC<sub>B3</sub>, 4xC<sub>A2</sub>, 4xC<sub>A3</sub>, 4xC<sub>A4</sub>, 4xC<sub>B5</sub> and 4xC<sub>C3</sub>); 68.0, 67.8, 67.7, 67.6, 67.5, 67.5, 67.3, 67.2, 67.2, 67.0, 66.6, 66.5, 66.5, 66.4, 66.1, 65.9 (Bn, 4xC<sub>C5</sub>, 4xC<sub>A5</sub> and 4xC<sub>A6</sub>); 53.0, 51.6, 51.5, 51.2 (4xC<sub>C4</sub>); 48.7, 48.5 (4xC<sub>C2</sub>); 34.0, 28.0, 27.8, 27.3, 27.3, 27.3, 23.8, 23.5, 23.5, 23.4, 23.4, 20.8, 20.7; 16.5, 16.4, 16.3 (4xC<sub>C6</sub>). [α]<sub>D</sub><sup>20</sup> = +105° (c = 1.0, CHCl<sub>3</sub>). IR (neat): 645, 649, 695, 733, 798, 825, 862, 907, 919, 922, 976, 998, 1028, 1037, 1094, 1457, 1507, 1653, 1684, 1700, 1717, 2930, 3675. HR-MS: [M+2H]<sup>+</sup> Calculated for C<sub>268</sub>H<sub>328</sub>N<sub>8</sub>O<sub>66</sub>Si<sub>4</sub>: 2414.0889; found: 2414.0906.

## Chapter 7

**Dodecaasaccharide 12:** The title compound was obtained by the general procedure for deprotecting of the di-*tert*-

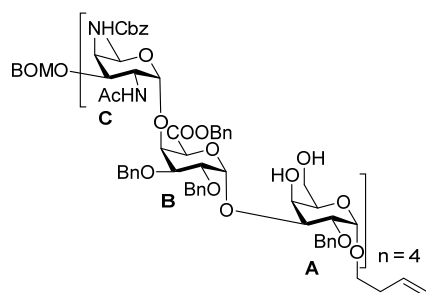

butyl silylidene ketal from compound **56**. 161 mg, yield: 91%.

$R_f = 0.24$  (DCM/MeOH, 30:1).  $^1\text{H NMR}$  (600 MHz, Chloroform-*d*)  $\delta$  7.41 – 6.95 (m, 105H), 6.21 (d,  $J = 9.3$  Hz, 1H, N-H), 6.16 (d,  $J = 9.3$  Hz, 1H, N-H), 6.09 (d,  $J = 9.4$  Hz, 1H, N-H), 5.79 (m, 1H), 5.71 (d,  $J = 9.6$  Hz, 1H, N-H), 5.29 (bs, 3H, 3xH<sub>B1</sub>), 5.22 – 4.36 (m, 47H, 1xH<sub>B1</sub>, 4xH<sub>A1</sub>, 1xH<sub>B5</sub>, 4xH<sub>C1</sub>), 4.35 – 3.41 (m, 42H, 3xH<sub>B5</sub>, 4xH<sub>B4</sub>, 4xH<sub>C5</sub>, 4xH<sub>C4</sub>, 4xH<sub>C2</sub>, 4xH<sub>A2</sub>, 4xH<sub>A3</sub>, 4xH<sub>B2</sub>, 4xH<sub>B3</sub>, 4xH<sub>A6</sub>, 4xH<sub>A4</sub>, 4xH<sub>A5</sub>), 2.49 (bs, 8H, 8x-OH), 2.35 (q,  $J = 6.9$  Hz,

2H), 2.13 – 2.02 (m, 12H, 4xCH<sub>3</sub>CONH-), 0.93 – 0.66 (m, 12H, 4xH<sub>C6</sub>).  $^{13}\text{C NMR}$  (151 MHz, CDCl<sub>3</sub>)  $\delta$  171.4, 171.3, 171.0, 170.9, 168.2, 168.1, 168.0, 157.1, 157.1, 138.7, 138.6, 138.5, 138.2, 138.2, 138.0, 138.0, 137.9, 137.9, 137.7, 137.3, 137.1, 137.1, 137.0, 136.6, 136.3, 134.9, 134.4, 134.3, 134.2, 134.2, 129.2, 129.2, 129.2, 129.1, 129.1, 129.0, 129.0, 128.9, 128.9, 128.9, 128.8, 128.8, 128.8, 128.7, 128.66, 128.6, 128.6, 128.6, 128.6, 128.5, 128.5, 128.4, 128.4, 128.3, 128.3, 128.2, 128.1, 128.1, 128.1, 128.1, 128.0, 128.0, 128.0, 127.9, 127.9, 127.9, 127.9, 127.8, 127.8, 127.7, 127.7, 127.7, 127.5, 127.5, 127.5, 127.4, 127.4, 127.3, 117.0; 99.9, 99.4, 99.2 (4xH<sub>C1</sub>); 96.9, 95.1, 94.5 (4xH<sub>A1</sub>); 94.3, 92.8, 92.7, 92.6, 92.4 (BOM, 4xH<sub>B1</sub>); 76.6, 76.5, 76.4, 75.8, 75.7, 75.0, 74.8, 74.7, 74.7, 74.6, 74.6, 74.5, 74.1, 74.1, 74.0, 72.4 (Bn, 4xH<sub>B4</sub>, 4xH<sub>C3</sub>, 4xH<sub>B2</sub>, 4xH<sub>A2</sub>, 4xH<sub>A3</sub>); 73.0, 73.0, 72.9, 72.8, 72.7, 71.9, 71.8, 71.6 (Bn), 70.8, 70.7, 70.6, 70.4, 70.0, 69.6, 68.6, 67.8, 67.8, 67.6, 67.6, 67.5, 67.2, 67.1, 67.0, 66.7, 66.6, 66.5, 66.1 (Bn, 4xH<sub>B5</sub>, 4xH<sub>C3</sub>, 4xH<sub>A4</sub>, 4xH<sub>A5</sub>, 4xH<sub>C5</sub>); 63.4, 63.4, 63.0 (4xH<sub>A6</sub>); 52.9, 51.1, 51.0 (4xH<sub>C4</sub>); 48.50 (4xH<sub>C2</sub>); 33.9, 23.6, 23.6; 16.6, 16.5, 16.4, 16.4 (4xH<sub>C6</sub>).  $[\alpha]_D^{20} = +126^\circ$  ( $c = 1.0$ , CHCl<sub>3</sub>). IR (neat): 697, 733, 749, 800, 825, 977, 995, 1028, 1079, 1093, 1241, 1457, 1507, 1653, 1684, 1700, 1717, 2930, 3675. HR-MS  $[M+2\text{H}^+]$  Calculated for C<sub>236</sub>H<sub>264</sub>N<sub>8</sub>O<sub>66</sub>: 2133.8847; found: 2133.8735.

**Hexasaccharide 6:** The title compound was obtained by the general oxidation procedure B or C, then do

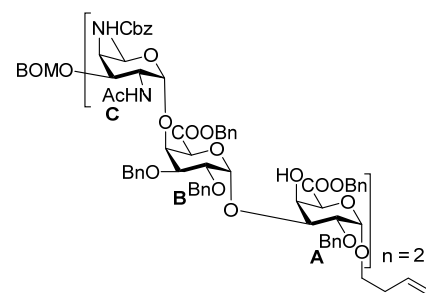

benzylation by use of BnBr and Cs<sub>2</sub>CO<sub>3</sub>. 15 mg, yield:

67%/63%.  $R_f = 0.27$  (DCM/MeOH, 20:1).  $^1\text{H NMR}$  (500 MHz, Acetone-*d*<sub>6</sub>)  $\delta$  7.51 – 7.08 (m, 65H), 6.64 (d,  $J = 10.0$  Hz, 1H, N-H), 6.52 (d,  $J = 10.1$  Hz, 1H, N-H), 6.26 (d,  $J = 8.7$  Hz, 1H, N-H), 6.19 (d,  $J = 9.3$  Hz, 1H, N-H), 5.96 – 5.77 (m, 1H), 5.39 – 4.92 (m, 19H, 2xH<sub>A1</sub>, 2xH<sub>B1</sub>), 4.89 – 4.40 (m, 21H, 2xH<sub>C1</sub>, 2xH<sub>A4</sub>, 2xH<sub>A5</sub>, 2xH<sub>B5</sub>), 4.39 – 3.64 (m, 18H, 2xH<sub>C5</sub>, 2xH<sub>C3</sub>, 2xH<sub>C4</sub>, 2xH<sub>C2</sub>, 2xH<sub>A3</sub>, 2xH<sub>A2</sub>, 2xH<sub>B4</sub>, 2xH<sub>B3</sub>, 2xH<sub>B2</sub>), 3.61 – 3.46 (m, 1H), 2.42 –

2.29 (m, 2H), 1.96 (s, 3H), 1.91 (s, 3H), 0.87 – 0.75 (m, 6H, 2xH<sub>C6</sub>).  $^{13}\text{C NMR}$  (126 MHz, Acetone)  $\delta$  170.7, 170.5, 169.1, 168.9, 168.7, 158.2, 158.1, 139.9, 139.8, 139.8, 139.7, 139.6, 138.8, 138.7, 138.5, 137.3, 137.2, 136.3, 136.1, 129.8, 129.8, 129.6, 129.6, 129.5, 129.5, 129.4, 129.4, 129.3, 129.2, 129.2, 129.2, 129.1, 129.1, 128.9,

128.9, 128.8, 128.8, 128.7, 128.7, 128.6, 128.5, 128.4, 128.4, 128.3, 128.3, 128.3, 128.2, 128.2, 116.9; 100.4, 100.1 (2xC<sub>C1</sub>); 98.0, 96.0, 95.6, 94.9 (2xC<sub>A1</sub>, 2xC<sub>B1</sub>); 93.9 (BOM), 77.7, 77.5, 77.2, 77.1, 76.0, 75.9, 75.5, 75.2, 75.0, 74.8 (2xC<sub>B4</sub>, 2xC<sub>B3</sub>, 2xC<sub>B2</sub>, 2xC<sub>A3</sub>, 2xC<sub>A2</sub>); 74.5, 74.4 (Bn), 73.5, 73.4 (2xC<sub>C3</sub>); 73.3, 73.2, 73.0, 72.9 (Bn); 71.7, 71.5, 71.2, 70.7 (2xC<sub>A5</sub>, 2xC<sub>B5</sub>); 69.9, 68.8 (Bn); 68.3, 68.2 (2xC<sub>A4</sub>); 67.8, 67.8 (Bn); 67.1, 66.9, 66.8, 66.6, 66.5 (Bn, 2xC<sub>C5</sub>); 54.3, 52.6 (2xC<sub>C4</sub>); 49.5, 49.2 (2xC<sub>C2</sub>); 34.8, 23.8, 23.7; 17.1, 17.1 (2xC<sub>C6</sub>).  $[\alpha]_D^{20} = +87^\circ$  (c = 0.33, CHCl<sub>3</sub>). IR (neat): 603, 650, 700, 723, 739, 752, 789, 800, 825, 974, 1001, 1047, 1076, 1099, 1112, 1175, 1263, 1371, 1472, 1714, 2857, 2931. HR-MS: [M+H<sup>+</sup>] Calculated for C<sub>138</sub>H<sub>148</sub>N<sub>4</sub>O<sub>36</sub>: 2437.9946; found: 2437.9851.

**Nonasaccharide 7:** The title compound was obtained by the general oxidation procedure B or C, then do

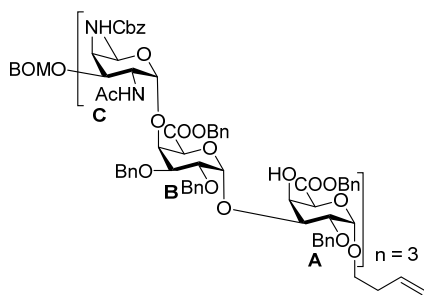

benzylation by use of BnBr and Cs<sub>2</sub>CO<sub>3</sub> or

phenyldiazomethane. 8 mg, yield: 89%/57%. *R<sub>f</sub>* = 0.28

(DCM/MeOH, 20:1). <sup>1</sup>H NMR (600 MHz, Chloroform-*d*) δ 7.46

– 6.89 (m, 80H), 5.83 – 5.70 (m, 3H, 3xN-H, -OCH<sub>2</sub>CH<sub>2</sub>CH=CH<sub>2</sub>),

5.64 (d, *J* = 9.5 Hz, 1H), 5.43 – 4.80 (m, 24H, 3xH<sub>A1</sub>, 3xH<sub>B1</sub>),

4.76 – 4.19 (m, 30H, 3xH<sub>C1</sub>, 3xH<sub>A4</sub>, 3xH<sub>A5</sub>, 3xH<sub>B5</sub>), 4.19 – 3.42

(m, 25H, 3xH<sub>C5</sub>, 3xH<sub>C3</sub>, 3xH<sub>C4</sub>, 3xH<sub>C2</sub>, 2xH<sub>A3</sub>, 2xH<sub>A2</sub>, 2xH<sub>B4</sub>, 2xH<sub>B3</sub>,

2xH<sub>B2</sub>), 2.39 – 2.29 (m, 2H), 2.07 (s, 3H), 2.02 (s, 3H), 2.00 (s,

3H), 0.93 – 0.71 (m, 9H, 3xH<sub>C6</sub>). <sup>13</sup>C NMR (151 MHz, CDCl<sub>3</sub>) δ 171.0, 170.9, 170.8, 168.5, 168.1, 168.0, 157.1, 157.0,

138.5, 138.5, 138.0, 138.0, 137.9, 137.9, 137.9, 137.0, 136.8, 136.7, 136.5, 135.6, 135.5, 135.4, 134.8, 134.4,

134.3, 134.3, 129.2, 129.2, 129.1, 129.0, 129.0, 129.0, 128.9, 128.9, 128.8, 128.8, 128.8, 128.8, 128.6, 128.6,

128.6, 128.6, 128.6, 128.5, 128.5, 128.5, 128.4, 128.4, 128.4, 128.4, 128.3, 128.2, 128.1, 128.1, 128.0, 128.0,

127.9, 127.9, 127.7, 127.7, 127.7, 127.6, 127.6, 127.5, 127.5, 127.4, 127.4, 117.1; 99.8, 99.6, 99.5 (3xC<sub>C1</sub>); 97.2,

95.4, 95.2, 94.7, 94.5, 94.4 (3xC<sub>A1</sub>, 3xC<sub>B1</sub>); 92.5 (BOM), 77.2, 77.1, 77.0 (3xC<sub>B4</sub>); 76.3, 75.9, 75.6, 74.6, 74.5, 74.4,

74.3, 74.2, 74.2, 74.0 (Bn, 3xC<sub>B3</sub>, 3xC<sub>B2</sub>, 3xC<sub>A3</sub>, 3xC<sub>A2</sub>); 73.2, 73.2, 73.0, 72.8, 72.3 (Bn, 3xC<sub>C3</sub>); 71.0, 70.9, 70.8, 70.4,

70.3, 69.6 (3xC<sub>B5</sub>, 3xC<sub>A5</sub>); 69.6, 68.2, 67.7, 67.7, 67.6, 67.3, 67.2, 67.2, 67.1 (Bn); 67.0, 66.9 (3xC<sub>A4</sub>); 66.5 (Bn), 66.3,

66.2 (3xC<sub>C5</sub>); 52.9, 51.7 (3xC<sub>C4</sub>); 48.5, 48.4 (3xC<sub>C2</sub>); 33.9, 23.8, 23.6; 16.6, 16.6, 16.5 (3xC<sub>C6</sub>).  $[\alpha]_D^{20} = +102^\circ$  (c = 1.0,

CHCl<sub>3</sub>). IR (neat): 699, 803, 1030, 1095, 1363, 1419, 1457, 1507, 1560, 1653, 1684, 1700, 1717, 1734, 2930, 3675.

HR-MS: [M+2H<sup>+</sup>] Calculated for C<sub>201</sub>H<sub>214</sub>N<sub>6</sub>O<sub>53</sub>: 1780.7190; found: 1780.6991.

## Chapter 7

**Dodecasaccharide 8:** The title compound was obtained by the general oxidation procedure B or C, then do

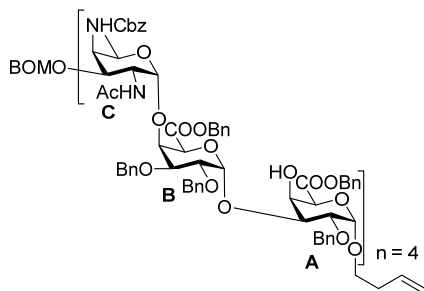

benzylation by use of phenyldiazomethane. 18 mg, yield: 49%.

$R_f = 0.7$  (toluene/acetone, 2:1).  $^1\text{H}$  NMR (600 MHz, Acetonitrile- $d_3$ )  $\delta$  7.50 – 6.98 (m, 125H), 6.08 (m, 4H, 4xN-H), 5.98 – 5.69 (m, 5H, 4xN-H,  $-\text{OCH}_2\text{CH}_2\text{CH}=\text{CH}_2$ ), 5.37 – 4.89 (m, 27H, 4xH<sub>A1</sub>, 4xH<sub>B1</sub>), 4.85 – 4.40 (m, 27H, 4xH<sub>C1</sub>, 4xH<sub>A5</sub>), 4.40 – 3.45 (m, 87H, 4xH<sub>A4</sub>, 4xH<sub>B5</sub>, 3xH<sub>C5</sub>, 3xH<sub>C3</sub>, 3xH<sub>C4</sub>, 3xH<sub>C2</sub>, 2xH<sub>A3</sub>, 2xH<sub>A2</sub>, 2xH<sub>B4</sub>, 2xH<sub>B3</sub>, 2xH<sub>B2</sub>), 3.32 (bs, 1H, -OH), 3.28 (d,  $J = 5.1$  Hz, 1H, -OH), 2.38 – 2.27 (m, 2H), 1.97 (m, 6H, 2xCH<sub>3</sub>CONH-),

1.91 (s, 3H, 1xCH<sub>3</sub>CONH-), 1.89 (s, 3H, 3xCH<sub>3</sub>CONH-), 0.81 – 0.52 (m, 12H, 4xH<sub>C6</sub>).  $^{13}\text{C}$  NMR (151 MHz, CD<sub>3</sub>CN)  $\delta$  170.8, 170.6, 170.6, 169.2, 169.2, 169.1, 169.0, 168.8, 168.7, 158.1, 158.0, 139.6, 139.6, 139.5, 139.5, 139.4, 138.7, 138.4, 138.4, 138.3, 138.1, 137.0, 137.0, 137.0, 136.9, 136.5, 136.4, 136.0, 135.9, 135.9, 129.9, 129.9, 129.8, 129.7, 129.7, 129.7, 129.7, 129.7, 129.6, 129.6, 129.6, 129.6, 129.5, 129.5, 129.5, 129.5, 129.4, 129.4, 129.4, 129.3, 129.3, 129.3, 129.2, 129.2, 129.2, 129.2, 129.1, 129.1, 129.1, 129.1, 129.0, 128.9, 128.9, 128.9, 128.8, 128.8, 128.7, 128.7, 128.7, 128.6, 128.6, 128.5, 128.5, 128.4, 128.4, 128.4, 128.4, 128.3, 128.3, 128.3, 128.3, 128.2, 128.2, 117.0, 116.9; 99.9, 99.7, 99.3, 99.1 (4xC<sub>C1</sub>); 97.7, 95.9, 95.7, 95.5, 93.9, 93.7 (4xC<sub>A1</sub> and 4xC<sub>B1</sub>); 93.8 (BOM), 79.5, 77.3, 77.1, 76.9, 76.7, 76.5, 75.8, 75.6, 75.3, 75.2, 75.1, 74.9, 74.7, 74.3, 74.3, 73.3, 73.2, 73.2, 73.1, 73.0, 73.0, 72.4, 72.2 (Bn, 4xC<sub>B4</sub>, 4xC<sub>B3</sub>, 4xC<sub>B2</sub>, 4xC<sub>A3</sub>, 4xC<sub>A2</sub>, 4xC<sub>C3</sub>); 71.6, 71.6, 71.3, 71.2, 70.9, 70.8, 70.4 (4xC<sub>B5</sub>, 4xC<sub>A5</sub>); 70.0, 68.6 (Bn), 68.2, 68.1, 68.1 (4xC<sub>A4</sub>); 68.1, 68.0, 68.0, 67.9, 67.9, 67.2, 67.2, 67.1, 66.9, 66.8, 66.7, 66.7 (Bn); 66.5, 66.4 (4xC<sub>C5</sub>); 55.0, 53.9, 51.9, 51.8 (4xC<sub>C4</sub>); 49.2, 48.9 (4xC<sub>C2</sub>); 34.5, 23.8, 23.8, 23.6; 16.9, 16.7, 16.7 (4xC<sub>C6</sub>).  $[\alpha]_D^{20} = +101^\circ$  ( $c = 0.5$ , CHCl<sub>3</sub>). IR (neat): 698, 737, 799, 1028, 1092, 1260, 1339, 1458, 1507, 1521, 1653, 1700, 1734, 2930, 3675. HR-MS:  $[\text{M}+2\text{H}^+]$  Calculated for C<sub>264</sub>H<sub>280</sub>N<sub>8</sub>O<sub>70</sub>: 2341.9371; found: 2341.9355.

**59 1,1-di-trimer-di-Lev:** The byproduct from glycosylation.  $^1\text{H}$  NMR (600 MHz, Chloroform- $d$ )  $\delta$  7.42 – 7.08 (m, 50H),

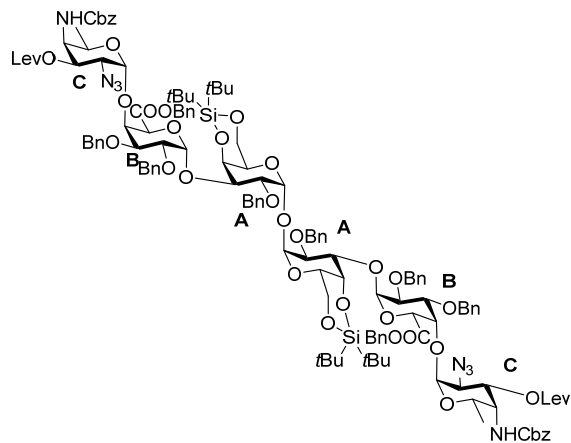

5.56 (d,  $J = 3.4$  Hz, 2H, H<sub>B1</sub>), 5.23 (d,  $J = 12.3$  Hz, 2H), 5.18 – 5.07 (m, 4H, H<sub>C3</sub>), 5.07 – 4.98 (m, 6H, H<sub>A1</sub>), 4.84 (dd,  $J = 24.0, 10.5$  Hz, 4H), 4.72 – 4.59 (m, 10H, H<sub>C1</sub>, H<sub>B5</sub>), 4.58 – 4.51 (m, 4H, H<sub>A4</sub>), 4.42 – 4.31 (m, 6H, H<sub>B4</sub>, H<sub>C5</sub>), 4.07 (m, 2H, H<sub>C4</sub>), 4.01 – 3.88 (m, 8H, H<sub>A2</sub>, H<sub>A3</sub>, H<sub>B2</sub>, H<sub>B3</sub>), 3.82 (q,  $J = 14.2, 13.0$  Hz, 6H, H<sub>A5</sub>, H<sub>A6</sub>), 3.11 (dd,  $J = 11.3, 4.0$  Hz, 2H, H<sub>C2</sub>), 2.83 – 2.73 (m, 2H), 2.68 (m, 2H), 2.63 – 2.52 (m, 2H), 2.43 (m, 2H), 2.17 (d,  $J = 1.8$  Hz, 6H), 0.93 (s, 18H), 0.87 (s, 18H), 0.76 (d,  $J = 6.3$  Hz, 6H, H<sub>C6</sub>).  $^{13}\text{C}$



NMR (151 MHz,  $\text{CDCl}_3$ )  $\delta$  172.0, 168.2, 156.7, 138.4, 138.2, 138.1, 136.5, 135.2, 128.8, 128.7, 128.7, 128.6, 128.6, 128.5, 128.5, 128.4, 128.4, 128.3, 128.2, 128.1, 127.9, 127.8, 127.7, 127.7, 98.8 ( $\text{C}_{\text{C1}}$ ), 94.3 ( $\text{C}_{\text{A1}}$ ), 93.6 ( $\text{C}_{\text{B1}}$ ), 77.1 ( $\text{C}_{\text{B4}}$ ), 75.6 ( $\text{C}_{\text{B3}}$ ), 75.3 ( $\text{C}_{\text{B2}}$ ), 74.2 ( $\text{C}_{\text{A3}}$ ), 73.6 ( $\text{C}_{\text{A2}}$ ), 73.3, 73.2, 72.4 (Bn), 70.6 ( $\text{C}_{\text{A4}}$ ), 70.4 ( $\text{C}_{\text{B5}}$ ), 70.2 ( $\text{C}_{\text{C3}}$ ), 67.5 (Bn), 67.4 ( $\text{C}_{\text{A5}}$ ), 67.1 and 67.1 (Bn, and  $\text{C}_{\text{A6}}$ ), 64.9 ( $\text{C}_{\text{C5}}$ ), 57.7 ( $\text{C}_{\text{C2}}$ ), 52.8 ( $\text{C}_{\text{C4}}$ ), 38.1, 27.7, 27.4, 23.3, 20.7, 16.2 ( $\text{C}_{\text{C6}}$ ). IR (neat): 650, 698, 737, 798, 827, 977, 999, 1038, 1099, 1148, 1456, 1521, 1717, 2112, 2859, 2934. HR-MS:  $[\text{M}+\text{H}^+]$  Calculated for  $\text{C}_{134}\text{H}_{162}\text{N}_8\text{O}_{35}\text{Si}_2$ : 2500.0754; found: 2500.0710.

**1,1-di-trimer-di-OH:** The title compound was obtained by the general procedure for delevulinoylation.  $^1\text{H}$  NMR

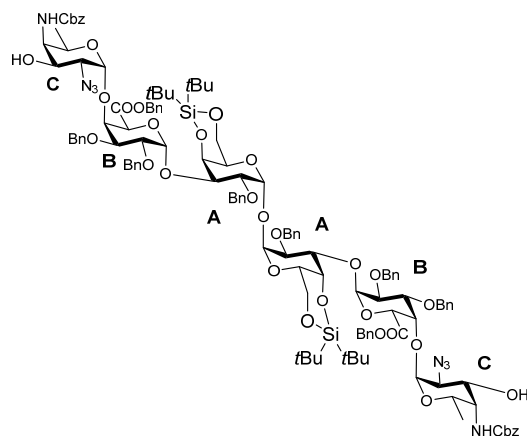

(400 MHz, Chloroform-*d*)  $\delta$  7.45 – 7.01 (m, 50H), 5.58 (s, 2H,  $\text{H}_{\text{B1}}$ ), 5.21 (d,  $J = 12.2$  Hz, 2H), 5.14 – 5.04 (m, 8H,  $\text{H}_{\text{A1}}$ ), 5.01 (d,  $J = 7.8$  Hz, 2H), 4.92 (d,  $J = 8.8$  Hz, 2H, N-H), 4.83 (d,  $J = 11.9$  Hz, 2H), 4.76 – 4.47 (m, 16H,  $\text{H}_{\text{B5}}$ ,  $\text{H}_{\text{A4}}$ ,  $\text{H}_{\text{C1}}$ ), 4.45 – 4.34 (m, 4H,  $\text{H}_{\text{B4}}$ ), 4.30 (d,  $J = 7.2$  Hz, 2H,  $\text{H}_{\text{C5}}$ ), 4.13 – 3.72 (m, 18H,  $\text{H}_{\text{C3}}$ ,  $\text{H}_{\text{A2}}$ ,  $\text{H}_{\text{A3}}$ ,  $\text{H}_{\text{B2}}$ ,  $\text{H}_{\text{B3}}$ ,  $\text{H}_{\text{C4}}$ ,  $\text{H}_{\text{A5}}$ ,  $\text{H}_{\text{A6}}$ ), 2.87 (dd,  $J = 10.7$ , 3.8 Hz, 2H,  $\text{H}_{\text{C2}}$ ), 0.94 (s, 18H), 0.90 (s, 18H), 0.80 (d,  $J = 6.4$  Hz, 6H,  $\text{H}_{\text{C6}}$ ).  $^{13}\text{C}$  NMR (101 MHz,  $\text{CDCl}_3$ )  $\delta$  168.2, 158.4, 138.4, 138.3, 138.1, 136.0, 135.1, 128.8, 128.8, 128.7, 128.7, 128.6,

128.5, 128.5, 128.5, 128.4, 128.3, 128.3, 128.3, 128.1, 127.9, 127.8, 127.8, 127.7, 127.7, 127.7, 98.9 ( $\text{C}_{\text{C1}}$ ), 94.3 ( $\text{C}_{\text{A1}}$ ), 93.8 ( $\text{C}_{\text{B1}}$ ), 76.7 ( $\text{C}_{\text{B4}}$ ), 75.9 ( $\text{C}_{\text{B3}}$ ), 75.0 ( $\text{C}_{\text{B2}}$ ), 74.4 ( $\text{C}_{\text{A3}}$ ), 73.7 ( $\text{C}_{\text{A2}}$ ), 73.2, 73.1, 72.2 (Bn), 70.8 ( $\text{C}_{\text{A4}}$ ), 70.47 ( $\text{C}_{\text{B5}}$ ), 68.6 ( $\text{C}_{\text{C3}}$ ), 67.7, 67.5 (Bn), 67.5 ( $\text{C}_{\text{A5}}$ ), 67.1 ( $\text{C}_{\text{A6}}$ ), 65.1 ( $\text{C}_{\text{C5}}$ ), 60.7 ( $\text{C}_{\text{C2}}$ ), 56.0 ( $\text{C}_{\text{C4}}$ ), 27.7, 27.4, 27.3, 23.3, 20.8, 16.4 ( $\text{C}_{\text{C6}}$ ).  $[\alpha]_{\text{D}}^{20} = 134^\circ$  ( $c = 0.68$ ,  $\text{CHCl}_3$ ). IR (neat): 668, 698, 976, 1029, 1099, 1340, 1419, 1457, 1653, 1700, 1717, 1739, 2930, 3675. HR-MS:  $[\text{M}+\text{H}^+]$  Calculated for  $\text{C}_{124}\text{H}_{150}\text{N}_8\text{O}_{31}\text{Si}_2$ : 2304.0018; found: 2303.9976.

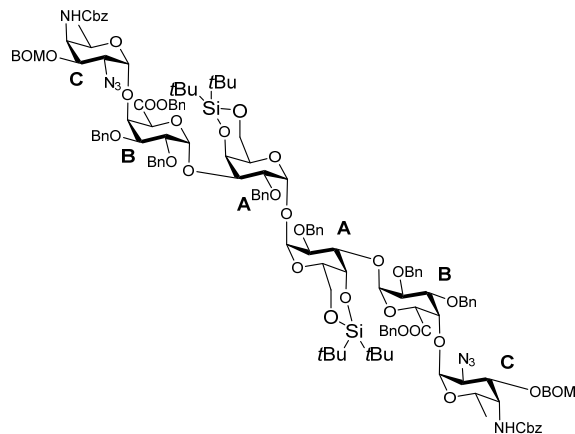

**1,1-di-trimer-di-BOM:** The title compound was obtained by the general procedure for BOM protection from compound **1,1-di-trimer-di-OH**. 94 mg, yield: 64%.  $R_f = 0.8$  (toluene/EtOAc, 3:1).  $^1\text{H}$  NMR (400 MHz, Chloroform-*d*)  $\delta$  7.46 – 7.07 (m, 50H), 5.58 (d,  $J = 3.0$  Hz, 2H,  $\text{H}_{\text{B1}}$ ), 5.25 (d,  $J = 12.2$  Hz, 2H), 5.12 – 4.94 (m, 8H,  $\text{H}_{\text{A1}}$ ), 4.88 – 4.51 (m, 24H,  $\text{H}_{\text{B5}}$ ,  $\text{H}_{\text{A4}}$ ,  $\text{H}_{\text{C1}}$ ), 4.46 – 4.33 (m, 4H,  $\text{H}_{\text{B4}}$ ), 4.23 (d,  $J = 6.6$  Hz, 2H,  $\text{H}_{\text{C5}}$ ), 4.08 (dd,  $J = 10.9$ , 4.0

## Chapter 7

Hz, 2H, H<sub>C3</sub>), 4.04 – 3.75 (m, 16H, H<sub>A2</sub>, H<sub>A3</sub>, H<sub>B2</sub>, H<sub>B3</sub>, H<sub>C4</sub>, H<sub>A5</sub>, H<sub>A6</sub>), 2.88 (dd,  $J = 10.9, 3.9$  Hz, 2H), 0.93 (s, 18H), 0.88 (s, 18H), 0.80 (d,  $J = 6.3$  Hz, 6H, H<sub>C6</sub>). <sup>13</sup>C NMR (101 MHz, CDCl<sub>3</sub>)  $\delta$  168.1, 156.9, 138.3, 138.2, 138.0, 137.8, 136.4, 135.1, 128.7, 128.7, 128.6, 128.5, 128.5, 128.5, 128.4, 128.3, 128.1, 128.1, 128.1, 127.9, 127.8, 127.7, 127.7, 127.6, 98.7 (C<sub>C1</sub>), 94.3 (C<sub>A1</sub>), 93.6 (C<sub>B1</sub>), 92.4 (BOM), 76.7 (C<sub>B4</sub>), 75.5 (C<sub>B3</sub>), 75.1 (C<sub>B2</sub>), 74.1 (C<sub>A3</sub>), 73.6 (C<sub>A2</sub>), 73.2, 73.1, 72.2 (Bn); 71.1, 70.6 and 70.4 (C<sub>A4</sub>, C<sub>B5</sub>, C<sub>C3</sub>), 70.0 and 67.5 (Bn), 67.4 (C<sub>A5</sub>), 67.1 (Bn), 65.4 (C<sub>C5</sub>), 59.3 (C<sub>C2</sub>), 52.7 (C<sub>C4</sub>), 27.7, 27.3, 23.3, 20.7, 16.4 (C<sub>C6</sub>).  $[\alpha]_D^{20} = 168^\circ$  ( $c = 0.78$ , CHCl<sub>3</sub>). IR (neat): 698, 738, 800, 826, 1040, 1097, 1363, 1458, 1507, 1653, 1700, 1717, 1734, 2109, 2875, 2924, 3675.

**1,1-di-trimer-di-acetylamide:** The title compound was obtained by the general procedure for transferring an azide

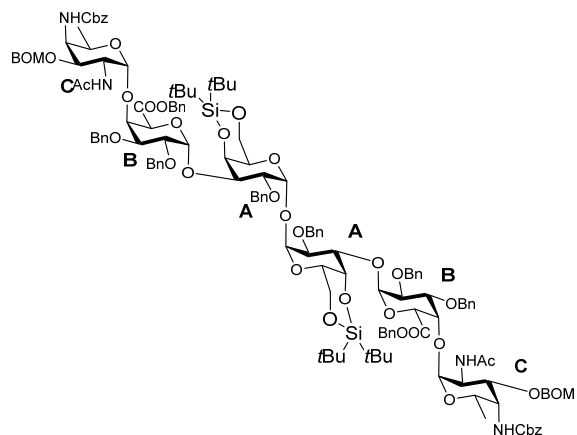

into acetylamino reactions for long oligosaccharides from compound **1,1-di-trimer-di-BOM**. 42 mg, yield: 88%.  $R_f = 0.73$  (DCM/MeOH, 20:1). <sup>1</sup>H NMR (400 MHz, Chloroform-*d*)  $\delta$  7.43 – 7.01 (m, 60H), 5.73 (bs, 2H, N-H), 5.48 (d,  $J = 1.9$  Hz, 2H, H<sub>B1</sub>), 5.18 – 4.97 (m, 8H, H<sub>A1</sub>, N-H), 4.85 (m, 8H), 4.75 – 4.41 (m, 16H, H<sub>B5</sub>, H<sub>A4</sub>, H<sub>C1</sub>), 4.25 – 3.59 (m, 22H, H<sub>B4</sub>, H<sub>C5</sub>, H<sub>C3</sub>, H<sub>A2</sub>, H<sub>A3</sub>, H<sub>B2</sub>, H<sub>B3</sub>, H<sub>C4</sub>, H<sub>A5</sub>, H<sub>A6</sub>), 1.98 (s, 6H), 0.95 (s, 18H), 0.91 (s, 18H), 0.84 (d,  $J = 6.2$  Hz, 6H, H<sub>C6</sub>). <sup>13</sup>C NMR

(101 MHz, CDCl<sub>3</sub>)  $\delta$  170.7, 157.1, 138.3, 137.9, 137.9, 137.8, 136.5, 134.1, 129.0, 128.9, 128.9, 128.6, 128.5, 128.3, 128.2, 128.1, 128.0, 128.0, 127.9, 127.8, 127.8, 127.7, 127.3, 99.5 (C<sub>C1</sub>), 95.6 (C<sub>B1</sub>), 94.6 (C<sub>A1</sub>), 92.6 (BOM), 77.4 (C<sub>B4</sub>), 75.9, 75.5, 74.4 and 73.7 (C<sub>B3</sub>, C<sub>B2</sub>, C<sub>A3</sub>, C<sub>A2</sub>); 73.4 (Bn); 72.6 (C<sub>C3</sub>), 72.5 (Bn), 71.1 and 70.7 (C<sub>A4</sub>, C<sub>B5</sub>), 69.5 (Bn), 67.5, 67.0, 66.9 (Bn, C<sub>A6</sub>), 65.9 (C<sub>C5</sub>), 52.8, 48.6, 27.6, 27.4, 23.6, 23.4, 20.7, 16.5 (C<sub>C6</sub>).  $[\alpha]_D^{20} = +139^\circ$  ( $c = 0.72$ , CHCl<sub>3</sub>). IR (neat): 698, 736, 1045, 1104, 1419, 1457, 1507, 1560, 1653, 1700, 1717, 1734, 2875, 2924, 3675. HR-MS  $[M+H]^+$  Calculated for C<sub>144</sub>H<sub>174</sub>N<sub>4</sub>O<sub>35</sub>Si<sub>2</sub>: 2576.1570; found: 2576.1548.

**60 1,1-di-trimer-tetra-OH:** The title compound was obtained by general procedure for deprotecting of the di-*tert*-

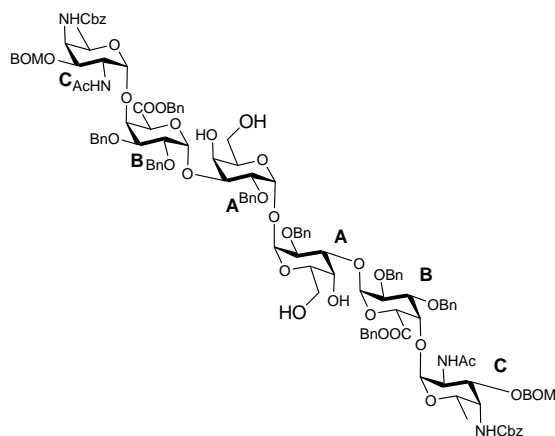

butyl silylidene ketal from compound **1,1-di-**

**trimer-di-acetylamide.** 29 mg, yield: 77%. *R<sub>f</sub>* = 0.45 (DCM/MeOH, 20:1). <sup>1</sup>H NMR (400 MHz, Chloroform-*d*) δ 7.44 – 7.03 (m, 60H), 5.66 (d, *J* = 9.5 Hz, 2H, H<sub>B1</sub>), 5.27 (d, *J* = 3.8 Hz, 2H), 5.18 – 4.83 (m, 12H, H<sub>A1</sub>), 4.81 – 4.60 (m, 10H), 4.55 (d, *J* = 11.9 Hz, 2H), 4.46 (d, *J* = 3.9 Hz, 2H, H<sub>C1</sub>), 4.44 – 4.34 (m, 4H, H<sub>B5</sub>), 4.30 (d, *J* = 6.6 Hz, 2H, H<sub>C5</sub>), 4.20 (d, *J* = 2.7 Hz, 2H, H<sub>B4</sub>), 4.17 – 3.65 (m, 16H, H<sub>A2</sub>, H<sub>A3</sub>, H<sub>B2</sub>, H<sub>B3</sub>, H<sub>C2</sub>, H<sub>C3</sub>, H<sub>C4</sub>), 3.43 (qd, *J* = 12.1, 4.6 Hz, 4H, H<sub>A6</sub>), 2.11 (s, 6H), 0.87 (d, *J* =

6.3 Hz, 6H, H<sub>C6</sub>). <sup>13</sup>C NMR (101 MHz, CDCl<sub>3</sub>) δ 170.8, 168.0, 157.1, 138.0, 137.8, 137.7, 136.7, 136.4, 134.1, 129.1, 129.0, 129.0, 128.9, 128.9, 128.8, 128.8, 128.7, 128.6, 128.6, 128.5, 128.2, 128.1, 128.1, 128.0, 128.0, 127.8, 127.5, 127.1, 127.0, 99.5 (C<sub>C1</sub>), 95.7 (C<sub>A1</sub>), 94.7 (C<sub>B1</sub>), 92.6 (BOM), 76.6 (C<sub>B4</sub>), 76.4 and 76.3 (C<sub>B3</sub>, C<sub>A3</sub>), 75.2 (Bn), 74.9 and 74.0 (C<sub>B2</sub>, C<sub>A2</sub>), 72.9 (Bn), 72.4 (C<sub>C3</sub>), 72.0 (Bn), 70.7 (C<sub>B5</sub>), 69.7 (Bn), 68.5 and 68.1 (C<sub>A4</sub>, C<sub>A5</sub>), 67.6 and 67.1 (Bn), 66.1 (C<sub>C5</sub>), 63.2 (C<sub>A6</sub>), 52.7 (C<sub>C4</sub>), 48.5 (C<sub>C2</sub>), 23.8, 16.6 (C<sub>C6</sub>). IR (neat): 698, 736, 987, 1028, 1045, 1092, 1115, 1457, 1507, 1560, 1653, 1700, 1717, 1734, 2875, 2924, 3675. HR-MS [M+H<sup>+</sup>] Calculated for C<sub>128</sub>H<sub>142</sub>N<sub>4</sub>O<sub>35</sub>: 2295.9527; found: 2295.9502.

**61 1,1-di-trimer-di-COOH:** The title compound was obtained by the general oxidation procedure B or C. 12 mg, yield: 85%. *R<sub>f</sub>* = 0.4(DCM/MeOH/AcOH, 20:2:0.05). <sup>1</sup>H NMR (400 MHz, Chloroform-*d*) δ 7.52 – 6.82 (m, 60H), 5.70

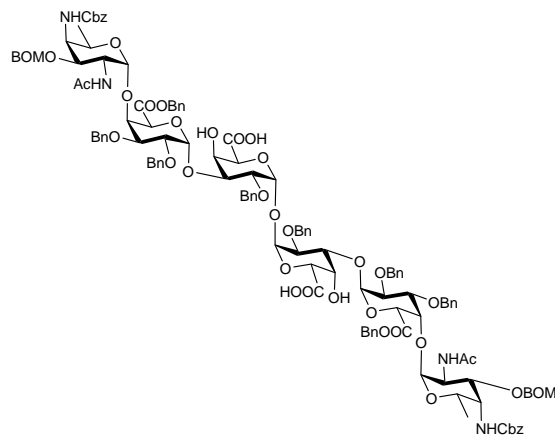

(d, *J* = 9.3 Hz, 2H), 5.25 (s, 2H), 5.18 – 4.86 (m, 10H), 4.83 – 4.52 (m, 14H), 4.51 – 4.22 (m, 8H), 4.20 – 3.95 (m, 6H), 3.92 – 3.55 (m, 6H), 2.04 (s, 6H), 0.89 (d, *J* = 5.6 Hz, 6H). <sup>13</sup>C NMR (101 MHz, CDCl<sub>3</sub>) δ 171.0, 167.7, 157.1, 137.8, 137.67, 137.2, 136.4, 136.4, 134.2, 129.1, 129.0, 129.0, 128.8, 128.6, 128.2, 128.1, 128.0, 127.9, 127.9, 127.8, 127.5, 99.4, 95.3, 92.6, 76.4, 76.0, 75.4, 74.8, 73.8, 73.5, 73.1, 72.8, 72.3, 70.7, 69.6, 67.6, 67.1, 66.8, 66.1, 52.7, 48.5, 29.8, 23.7, 16.6. [α]<sup>20</sup><sub>D</sub> = +118° (c = 0.48,

CHCl<sub>3</sub>). HR-MS: [M+H<sup>+</sup>] Calculated for C<sub>128</sub>H<sub>138</sub>N<sub>4</sub>O<sub>37</sub>: 2323.9113; found: 2323.9050.

## Chapter 7

**62 1,1-di-trimer:** The title compound was obtained by the general procedure for fully deprotection (saponification

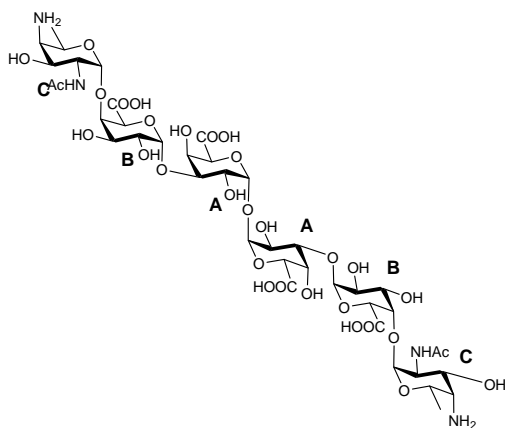

and Birch reduction) from compound **1,1-di-trimer-**

**di-COOH.**  $^1\text{H NMR}$  (500 MHz, Deuterium Oxide)  $\delta$

5.23 (dd,  $J = 7.7, 4.0$  Hz, 4H,  $\text{H}_{\text{A1}}, \text{H}_{\text{B1}}$ ), 4.93 (d,  $J = 3.8$  Hz, 2H,  $\text{H}_{\text{C1}}$ ), 4.74 – 4.67 (m, 2H,  $\text{H}_{\text{C5}}$ ), 4.55 (s, 2H,  $\text{H}_{\text{B5}}$ ), 4.46 (d,  $J = 3.2$  Hz, 2H,  $\text{H}_{\text{A4}}$ ), 4.34 (m, 4H,  $\text{H}_{\text{A5}}, \text{H}_{\text{B4}}$ ), 4.25 – 4.06 (m, 6H,  $\text{H}_{\text{A3}}, \text{H}_{\text{B3}}, \text{H}_{\text{C3}}$ ), 4.01 (dd,  $J = 11.3, 3.7$  Hz, 2H,  $\text{H}_{\text{C2}}$ ), 3.90 (ddd,  $J = 23.7, 10.5, 3.9$  Hz, 4H,  $\text{H}_{\text{A2}}, \text{H}_{\text{B2}}$ ), 3.54 (d,  $J = 4.4$  Hz, 2H,  $\text{H}_{\text{C4}}$ ), 2.14 – 2.00 (m, 6H,  $\text{CH}_3\text{CONH-}$ ), 1.23 (d,  $J = 6.7$  Hz, 6H,  $\text{H}_{\text{C6}}$ ).

$^{13}\text{C NMR}$  (126 MHz,  $\text{D}_2\text{O}$ )  $\delta$  175.3, 175.1, 174.7, 99.0 ( $\text{C}_{\text{C1}}$ ), 97.9 ( $\text{C}_{\text{B1}}$ ), 93.5 ( $\text{C}_{\text{A1}}$ ), 80.4 ( $\text{C}_{\text{B4}}$ ), 77.3 ( $\text{C}_{\text{A3}}$ ), 71.6

and 71.4 ( $\text{C}_{\text{A5}}, \text{C}_{\text{B5}}$ ), 68.6 ( $\text{C}_{\text{A4}}$ ), 68.5 ( $\text{C}_{\text{B3}}$ ), 68.0 ( $\text{C}_{\text{B2}}$ ), 66.5 ( $\text{C}_{\text{A2}}$ ), 65.1 ( $\text{C}_{\text{C3}}$ ), 63.8 ( $\text{C}_{\text{C5}}$ ), 55.2 ( $\text{C}_{\text{C4}}$ ), 49.3 ( $\text{C}_{\text{C2}}$ ), 22.4 ( $\text{C}_{\text{AcNH}}$ ), 15.5 ( $\text{C}_{\text{C6}}$ ).  $[\alpha]^{20}_{\text{D}} = 20^\circ$  ( $c = 0.1, \text{CHCl}_3$ ). HR-MS:  $[\text{M}+\text{H}^+]$  Calculated for  $\text{C}_{40}\text{H}_{62}\text{N}_4\text{O}_{31}$ : 1095.3471; found: 1095.3478.

**Hexasaccharide 2:** The title compound was obtained by the general procedure for fully deprotection

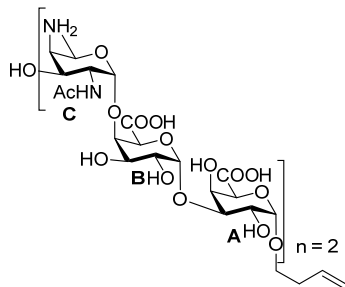

(saponification and Birch reduction) from compound **6.**  $^1\text{H NMR}$  (850

MHz, Deuterium Oxide)  $\delta$  5.83 (m, 1H,  $-\text{OCH}_2\text{CH}_2\text{CH}=\text{CH}_2$ ), 5.17 (d,  $J = 3.9$  Hz, 1H,  $\text{H}_{\text{B1}}$ ), 5.15 (d,  $J = 3.9$  Hz, 1H,  $\text{H}_{\text{B'1}}$ ), 5.09 (dd,  $J = 17.3, 2.0$  Hz, 1H,  $-\text{OCH}_2\text{CH}_2\text{CH}=\text{CH}_2$ ), 5.05 – 5.02 (m, 1H,  $-\text{OCH}_2\text{CH}_2\text{CH}=\text{CH}_2$ ), 5.01 (d,  $J = 4.1$  Hz, 1H,  $\text{H}_{\text{A'1}}$ ), 4.92 (d,  $J = 4.0$  Hz, 1H,  $\text{H}_{\text{A1}}$ ), 4.88 (d,  $J = 4.2$  Hz, 1H,  $\text{H}_{\text{C1}}$ ), 4.74 (d,  $J = 3.8$  Hz, 1H,  $\text{H}_{\text{C'1}}$ ), 4.58 (bs, 1H,  $\text{H}_{\text{C5}}$ ), 4.54 (s, 1H,  $\text{H}_{\text{B5}}$ ), 4.53 – 4.47 (m, 2H,  $\text{H}_{\text{C'5}}, \text{H}_{\text{B5}}$ ), 4.45 – 4.38 (m, 2H,  $\text{H}_{\text{A4}}, \text{H}_{\text{A'4}}$ ), 4.34 – 4.29

(m, 1H,  $\text{H}_{\text{B4}}$ ), 4.28 – 4.25 (m, 1H,  $\text{H}_{\text{B'4}}$ ), 4.24 (s, 1H,  $\text{H}_{\text{A5}}$ ), 4.15 (dd,  $J = 11.2, 4.0$  Hz, 1H,  $\text{H}_{\text{C2}}$ ), 4.09 – 4.00 (m, 5H,  $\text{H}_{\text{C'2}}, \text{H}_{\text{C3}}, \text{H}_{\text{A'5}}, \text{H}_{\text{B3}}, \text{H}_{\text{B'3}}$ ), 3.99 – 3.81 (m, 7H,  $\text{H}_{\text{C'3}}, \text{H}_{\text{A3}}, \text{H}_{\text{A'3}}, \text{H}_{\text{B2}}, \text{H}_{\text{B'2}}, \text{H}_{\text{A2}}, \text{H}_{\text{A'2}}$ ), 3.70 (m, 1H,  $-\text{OCH}_2\text{CH}_2\text{CH}=\text{CH}_2$ ), 3.60 (m, 1H,  $-\text{OCH}_2\text{CH}_2\text{CH}=\text{CH}_2$ ), 3.39 (bs, 1H,  $\text{H}_{\text{C4}}$ ), 3.10 (s, 1H,  $\text{H}_{\text{C'4}}$ ), 2.32 (q,  $J = 6.8$  Hz, 2H,  $-\text{OCH}_2\text{CH}_2\text{CH}=\text{CH}_2$ ), 2.04 (s, 3H,  $\text{CH}_3\text{CONH-}$ ), 2.00 (s, 3H,  $\text{CH}_3\text{CONH-}$ ), 1.16 (dd,  $J = 14.8, 6.4$  Hz, 6H,  $2\times\text{H}_{\text{C6}}$ ).  $^{13}\text{C NMR}$  (214 MHz,  $\text{D}_2\text{O}$ )  $\delta$  176.6, 176.0, 175.9, 175.7, 175.5, 175.5, 136.9 ( $-\text{OCH}_2\text{CH}_2\text{CH}=\text{CH}_2$ ), 117.5 ( $-\text{OCH}_2\text{CH}_2\text{CH}=\text{CH}_2$ ), 100.1 ( $\text{C}_{\text{C1}}$ ), 99.5 ( $\text{C}_{\text{C1}}$ ), 99.4 ( $\text{C}_{\text{A1}}$ ), 96.9 ( $\text{C}_{\text{A'1}}$ ), 97.8 ( $\text{C}_{\text{B'1}}$ ), 97.34 ( $\text{C}_{\text{B1}}$ ), 81.0 ( $\text{C}_{\text{B'4}}$ ), 80.2 ( $\text{C}_{\text{B4}}$ ), 77.2 ( $\text{C}_{\text{A'3}}$ ), 77.0 ( $\text{C}_{\text{A3}}$ ), 75.0 ( $\text{C}_{\text{C3}}$ ), 72.8 ( $\text{C}_{\text{A'5}}$ ), 72.3 ( $\text{C}_{\text{B'5}}$ ), 72.3 ( $\text{C}_{\text{B5}}$ ), 72.1 ( $\text{C}_{\text{B5}}$ ), 69.7 and 69.6 ( $\text{C}_{\text{B3}}, \text{C}_{\text{B'3}}$ ), 68.9 ( $-\text{OCH}_2\text{CH}_2\text{CH}=\text{CH}_2$ ), 69.0, 69.0, 68.8, 68.8 ( $\text{C}_{\text{A4}}, \text{C}_{\text{A'4}}, \text{C}_{\text{B2}}, \text{C}_{\text{B'2}}$ ), 68.5 ( $\text{C}_{\text{C3}}$ ), 67.6 ( $\text{C}_{\text{A2}}$ ), 67.3 ( $\text{C}_{\text{C'5}}$ ), 67.1 ( $\text{C}_{\text{A'2}}$ ), 55.1 ( $\text{C}_{\text{C'4}}$ ), 52.3 ( $\text{C}_{\text{C4}}$ ), 50.0 ( $\text{C}_{\text{C'2}}$ ), 48.3 ( $\text{C}_{\text{C2}}$ ), 34.3 ( $-\text{OCH}_2\text{CH}_2\text{CH}=\text{CH}_2$ ), 23.3 and 23.3 ( $\text{CH}_3\text{CONH-}$ ), 16.7 and 16.7 ( $\text{C}_{\text{C6}}, \text{C}_{\text{C6}}$ ).  $[\alpha]^{20}_{\text{D}} = +178^\circ$  ( $c = 0.1, \text{H}_2\text{O}$ ). HR-MS:  $[\text{M}+\text{H}^+]$  Calculated for  $\text{C}_{44}\text{H}_{68}\text{N}_4\text{O}_{31}$ : 1149.3940; found: 1149.3940.

**Nonasaccharide 3:** The title compound was obtained by general procedure for fully deprotection (saponification

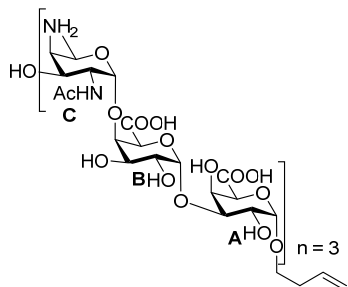

and Birch reduction) from compound **7**.  $^1\text{H}$  NMR (850 MHz, Deuterium Oxide)  $\delta$  5.85 (m, 1H,  $-\text{OCH}_2\text{CH}_2\text{CH}=\text{CH}_2$ ), 5.21 – 5.16 (m, 3H,  $3\times\text{H}_{\text{B}1}$ ), 5.11 (dq,  $J = 17.3, 1.7$  Hz, 1H,  $-\text{OCH}_2\text{CH}_2\text{CH}=\text{CH}_2$ ), 5.06 – 5.04 (m, 1H,  $-\text{OCH}_2\text{CH}_2\text{CH}=\text{CH}_2$ ), 5.03 (d,  $J = 4.2$  Hz, 1H,  $1\times\text{H}_{\text{A}1}$ ), 5.02 (d,  $J = 4.4$  Hz, 1H,  $1\times\text{H}_{\text{A}1}$ ), 4.94 (m, 3H,  $1\times\text{H}_{\text{A}1}, 1\times\text{H}_{\text{C}1}, 1\times\text{H}_{\text{C}1}$ ), 4.88 (d,  $J = 4.0$  Hz, 1H,  $1\times\text{H}_{\text{C}1}$ ), 4.74 (m, 2H,  $1\times\text{H}_{\text{C}5}, 1\times\text{H}_{\text{C}5}$ ), 4.67 (bs,  $1\times\text{H}_{\text{C}5}$ ), 4.59 (s, 1H,  $1\times\text{H}_{\text{B}5}$ ), 4.58 (s, 1H,  $1\times\text{H}_{\text{B}5}$ ), 4.51 (s, 1H,  $1\times\text{H}_{\text{B}5}$ ), 4.44 (bs, 1H,  $1\times\text{H}_{\text{A}4}$ ), 4.42 (m, 2H,  $1\times\text{H}_{\text{A}4}, 1\times\text{H}_{\text{A}4}$ ), 4.36 – 4.33 (m, 2H,  $1\times\text{H}_{\text{B}4}, 1\times\text{H}_{\text{B}4}$ ), 4.32 – 4.29 (m, 1H,  $1\times\text{H}_{\text{B}4}$ ),

4.25 (d,  $J = 1.4$  Hz, 1H,  $1\times\text{H}_{\text{A}5}$ ), 4.21 (m, 2H,  $1\times\text{H}_{\text{C}3}, 1\times\text{H}_{\text{C}3}$ ), 4.14 – 4.02 (m, 8H,  $\text{H}_{\text{C}2}, \text{H}_{\text{C}2}, \text{H}_{\text{C}3}, \text{H}_{\text{A}5}, \text{H}_{\text{A}5}, \text{H}_{\text{B}3}, \text{H}_{\text{B}3}, \text{H}_{\text{B}3}$ ), 4.03 – 3.96 (m, 4H,  $\text{H}_{\text{C}2}, 3\times\text{H}_{\text{A}3}$ ), 3.94 – 3.82 (m, 6H,  $3\times\text{H}_{\text{A}2}, 3\times\text{H}_{\text{B}2}$ ), 3.77 – 3.70 (m, 2H,  $\text{H}_{\text{C}4}, \text{H}_{\text{C}4}, -\text{OCH}_2\text{CH}_2\text{CH}=\text{CH}_2$ ), 3.62 (m, 1H,  $-\text{OCH}_2\text{CH}_2\text{CH}=\text{CH}_2$ ), 3.46 (bs, 1H,  $\text{H}_{\text{C}4}$ ), 2.34 (q,  $J = 7.6, 7.0$  Hz, 2H), 2.06 (s, 3H,  $\text{CH}_3\text{CONH}-$ ), 2.01 (s, 3H,  $\text{CH}_3\text{CONH}-$ ), 2.00 (s, 3H,  $\text{CH}_3\text{CONH}-$ ), 1.21 (m, 9H,  $3\times\text{H}_{\text{C}6}$ ).  $^{13}\text{C}$  NMR (214 MHz,  $\text{D}_2\text{O}$ )  $\delta$  176.6, 176.0, 175.9, 175.6, 175.6, 175.5, 175.5, 175.4, 136.9 ( $-\text{OCH}_2\text{CH}_2\text{CH}=\text{CH}_2$ ), 117.5 ( $-\text{OCH}_2\text{CH}_2\text{CH}=\text{CH}_2$ ); 99.9, 99.4 and 99.3 ( $3\times\text{C}_{\text{C}1}, 3\times\text{C}_{\text{A}1}$ ); 98.0, 97.6, 97.3 ( $3\times\text{C}_{\text{B}1}$ ); 81.0, 80.4, 80.3 ( $3\times\text{C}_{\text{B}4}$ ); 77.2, 77.0, 76.8 ( $3\times\text{C}_{\text{A}3}$ ); 74.4, 74.1 ( $\text{C}_{\text{C}3}, \text{C}_{\text{C}3}$ ); 73.1 ( $\text{C}_{\text{A}5}, \text{C}_{\text{A}5}$ ), 72.3 ( $\text{C}_{\text{A}5}$ ); 72.2, 72.0 and 71.9 ( $3\times\text{C}_{\text{B}5}$ ); 69.6, 69.5, 69.5 ( $3\times\text{C}_{\text{B}3}$ ); 69.1, 69.0, 68.8, 68.8, 68.8 ( $3\times\text{C}_{\text{A}4}, 3\times\text{C}_{\text{B}2}$ ); 68.9 ( $-\text{OCH}_2\text{CH}_2\text{CH}=\text{CH}_2$ ); 67.6, 66.8 and 66.7 ( $3\times\text{C}_{\text{A}2}$ ); 65.2 ( $\text{C}_{\text{C}5}$ ) and 64.0 ( $\text{C}_{\text{C}5}, \text{C}_{\text{C}5}$ , according to HSQC), 55.9 ( $\text{C}_{\text{C}4}$ ) and 53.8 ( $\text{C}_{\text{C}4}, \text{C}_{\text{C}4}$ ); 50.2 ( $\text{C}_{\text{C}2}$ ), 48.5 ( $\text{C}_{\text{C}2}, \text{C}_{\text{C}2}$ ); 34.3 ( $-\text{OCH}_2\text{CH}_2\text{CH}=\text{CH}_2$ ), 23.2 ( $\text{CH}_3\text{CONH}-$ ), 16.4 ( $3\times\text{C}_{\text{C}6}$ ).  $[\alpha]_{\text{D}}^{20} = +162^\circ$  ( $c = 0.05, \text{H}_2\text{O}$ ). HR-MS:  $[\text{M}+2\text{H}^+]$  Calculated for  $\text{C}_{25}\text{H}_{31}\text{N}_3\text{O}_7$ : 844.2830; found: 844.2855.

**Dodecasaccharide 4:** The title compound was obtained by the general procedure for fully deprotection

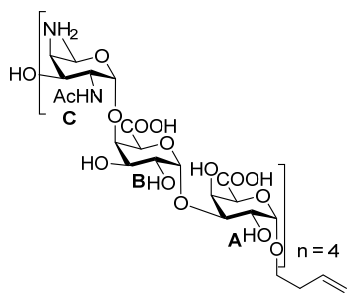

(saponification and Birch reduction) from compound **8**.  $^1\text{H}$  NMR (850 MHz, Deuterium Oxide)  $\delta$  5.83 (m, 1H,  $-\text{OCH}_2\text{CH}_2\text{CH}=\text{CH}_2$ ), 5.19 – 5.13 (m, 4H,  $4\times\text{H}_{\text{B}1}$ ), 5.09 (dd,  $J = 17.3, 1.8$  Hz, 1H,  $-\text{OCH}_2\text{CH}_2\text{CH}=\text{CH}_2$ ), 5.02 (m, 4H,  $-\text{OCH}_2\text{CH}_2\text{CH}=\text{CH}_2, \text{H}_{\text{A}1}, \text{H}_{\text{A}1}, \text{H}_{\text{A}1}$ ), 4.94 – 4.88 (m, 4H,  $\text{H}_{\text{C}1}, \text{H}_{\text{A}1}, \text{H}_{\text{C}1}, \text{H}_{\text{C}1}$ ), 4.86 (d,  $J = 3.9$  Hz, 1H,  $\text{H}_{\text{C}1}$ ), 4.70 (m, 3H,  $\text{H}_{\text{C}5}, \text{H}_{\text{C}5}, \text{H}_{\text{C}5}$ ), 4.63 (m, 1H,  $\text{H}_{\text{C}5}$ ), 4.58 (s, 1H,  $1\times\text{H}_{\text{B}5}$ ), 4.56 (d,  $J = 2.7$  Hz, 2H,  $2\times\text{H}_{\text{B}5}$ ), 4.49 (s, 1H,  $1\times\text{H}_{\text{B}5}$ ), 4.45 – 4.37 (m, 4H,  $4\times\text{H}_{\text{A}4}$ ), 4.32 (m, 3H,  $3\times\text{H}_{\text{B}4}$ ), 4.29 (bs, 1H,  $\text{H}_{\text{B}4}$ ), 4.24 (d,  $J = 1.3$  Hz, 1H,  $\text{H}_{\text{A}5}$ ), 4.22 – 4.14 (m, 3H,  $3\times\text{H}_{\text{C}3}$ ), 4.13 – 3.93 (m,

16H,  $4\times\text{H}_{\text{C}2}, \text{H}_{\text{C}3}, \text{H}_{\text{A}5}, \text{H}_{\text{A}5}, \text{H}_{\text{A}5}, 4\times\text{H}_{\text{B}3}, 4\times\text{H}_{\text{A}3}$ ), 3.92 – 3.81 (m, 8H,  $4\times\text{H}_{\text{A}2}, 4\times\text{H}_{\text{B}2}$ ), 3.74 – 3.64 (m, 4H,  $3\times\text{H}_{\text{C}4}, -\text{OCH}_2\text{CH}_2\text{CH}=\text{CH}_2$ ), 3.60 (m, 1H  $-\text{OCH}_2\text{CH}_2\text{CH}=\text{CH}_2$ ), 3.38 (d,  $J = 5.9$  Hz, 1H,  $\text{H}_{\text{C}4}$ ), 2.33 (q,  $J = 6.7$  Hz, 2H), 2.05 (s, 3H,  $1\times\text{CH}_3\text{CONH}-$ ), 2.02 – 1.92 (m, 9H,  $3\times\text{CH}_3\text{CONH}-$ ), 1.19 (m, 12H,  $4\times\text{H}_{\text{C}6}$ ).  $^{13}\text{C}$  NMR (214 MHz,  $\text{D}_2\text{O}$ )  $\delta$  176.5, 176.0, 175.9, 175.8, 175.6, 175.6, 175.5, 175.5, 175.4, 136.9 ( $-\text{OCH}_2\text{CH}_2\text{CH}=\text{CH}_2$ ), 117.5 ( $-\text{OCH}_2\text{CH}_2\text{CH}=\text{CH}_2$ ); 99.9, 99.4, 99.3 and 99.2 ( $4\times\text{C}_{\text{C}1}, 4\times\text{C}_{\text{A}1}$ ); 98.0, 97.6, 97.4, 97.3 ( $4\times\text{C}_{\text{B}1}$ ); 81.0, 80.4, 80.3 ( $4\times\text{C}_{\text{B}4}$ ); 77.2, 77.2, 76.9, 76.8 ( $4\times\text{C}_{\text{A}3}$ ); 74.5, 74.2 ( $3\times\text{C}_{\text{C}3}$ ); 73.1 ( $\text{C}_{\text{A}5}$ ); 72.3, 72.2, 72.0, 72.0 ( $4\times\text{C}_{\text{B}5}$ ); 69.7, 69.6, 69.5 ( $4\times\text{C}_{\text{B}3}$ ); 68.9 ( $-\text{OCH}_2\text{CH}_2\text{CH}=\text{CH}_2$ ), 69.1,

## Chapter 7

---

69.0, 68.9, 68.8 (4xC<sub>A4</sub>, 4xC<sub>B2</sub>); 67.6, 66.9, 66.8 (4xC<sub>A2</sub>); 65.5 (C<sub>C5</sub>, according to HSQC), 64.0(C<sub>C5</sub>, C<sub>C5</sub>, C<sub>C5</sub>), 55.8, 53.7, 53.5 (4xC<sub>C4</sub>); 50.2, 48.5 (4xC<sub>C2</sub>); 34.3 (-OCH<sub>2</sub>CH<sub>2</sub>CH=CH<sub>2</sub>), 23.3 (CH<sub>3</sub>CONH-), 23.2 (CH<sub>3</sub>CONH-); 16.5, 16.5, 16.4 (4xC<sub>C6</sub>).  $[\alpha]_D^{20} = +192^\circ$  (c = 0.05, H<sub>2</sub>O). HR-MS: [M+H<sup>+</sup>] Calculated for C<sub>84</sub>H<sub>128</sub>N<sub>8</sub>O<sub>61</sub>: 2225.7233; found: 2225.6348.

## 7.5 References

- [1] A. Tzianabos, A. Onderdonk, B. Rosner, R. Cisneros, D. L. Kasper, *Science*, **1993**, *262*, 416-419.
- [2] a) B. A. Cobb, Q. Wang, A. O. Tzianabos, D. L. Kasper, *Cell*, **2004**, *117*, 677-687; b) L. S. Kreisman, J. H. Friedman, A. Neaga, B. A. Cobb, *Glycobiology*, **2007**, *17*, 46-55; c) A. Tzianabos, J. Y. Wang, D. L. Kasper, *Carbohydr. Res*, **2003**, *338*, 2531-2538; d) S. K. Mazmanian, D. L. Kasper, *Nat. Rev. Immunol*, **2006**, *6*, 849-858.
- [3] Q. Zhang, H. S. Overkleeft, G. A. van der Marel, J. D. C. Codée, *Current Opinion in Chemical Biology*, **2017**, *40*, 95-101.
- [4] X. Wu, L. Cui, T. Lipinski, D. R. Bundle, *Chem. Eur. J*, **2010**, *16*, 3476-3488.
- [5] A. E. Christina, L. J. van den Bos, H. S. Overkleeft, G. A. van der Marel, J. D. C. Codée, *J. Org. Chem*, **2011**, *76*, 1692-1706.
- [6] B. Schumann, R. Pragani, C. Anish, C. L. Pereira, P. H. Seeberger, *Chem. Sci*, **2014**, *5*, 1992-2002.
- [7] a) S. Kim, S. Lee, T. Lee, H. Ko, D. Kim, *J. Org. Chem*, **2006**, *71*, 8661-8664; b) F. S. Ekholm, A. Arda, P. Eklund, S. Andre, H-J. Gabius, J. Jimenez-Barbero, R. Leino, *Chem. Eur. J*, **2012**, *18*, 14392-14405.
- [8] a) W. Yang, S. Ramadan, B. Yang, K. Yoshida, and X. Huang, *J. Org. Chem*, **2016**, *81*, 12052-12059; b) L. Huang, N. Teumelsan and X. Huang, *Chem. Eur. J*, **2006**, *12*, 5246-5252; c) B. Hagen, J. Hessel, M. van Dijk, Q. Zhang, H.S. Overkleeft, G.A. van der Marel and J.D.C. Codée, *Org. Lett*, **2017**, *19*, 2514-2517.
- [9] a) R. Roy, M-G Baek and K. Rittenhouse-Olson, *J. Am. Chem. Soc*, **2001**, *123*, 1809-816; b) X. Qian, S. J. Metallo, I. S. Choi, H. Wu, M. N. Liang and G. M. Whitesides, *Anal. Chem*, **2002**, *74*, 1805-1810; c) R. A. Ashmus, N. S. Schocker, Y. Cordero-Mendoza, A. F. Marques, E. Y. Monroy, A. Pardo, L. Izquierdo, M. Gállego, J. Gascon, I. C. Almeida and K. Michael, *Org. Biomol. Chem*, **2013**, *11*, 5579-5583.
- [10] a) M. Emmadi, S. S. Kulkarni, *Nat. Protoc*, **2013**, *8*, 1870-1889; b) M. Emmadi, S. S. Kulkarni, *Nat. Prod. Rep*, **2014**, *31*, 870-879.
- [11] J-C. Jacquinot, *Carbohydr. Res*, **2006**, *341*, 1630-1644.
- [12] a) L-D. Lu, C-R. Shie, S. S. Kulkarni, G-R. Pan, X-A. Lu, S-C. Hung, *Org. Lett*, **2006**, *8*, 5995-5998; b) H. Ochiai, W. Huang, L. Wang, *J. Am. Chem. Soc*, **2008**, *130*, 13790-13803.
- [13] Y-U. Kwon, R. L. Soucy, D. A. Snyder, P. H. Seeberger, *Chem. Eur. J*, **2005**, *11*, 2493-2504.

- [14] a) W. Q. Tian, Y. A. Wang, *J. Org. Chem*, **2004**, *69*, 4299-4308. b) F. L. Lin, H. M. Hoyt, H. v. Halbeek, R. G. Bergman, C. R. Bertozzi, *J. Am. Chem. Soc*, **2005**, *127*, 2686-2695.
- [15] TEMPO-mediated oxidation, In: G. Tojo, M. I. Fernandez. (eds) Oxidation of primary alcohols to carboxylic acids a guide to current common practice, **2007**, XVI, 116p, Springer-Verlag New York.
- [16] a) C. G. Overberger, and Jean-Pierre Anselme, *J. Org. Chem*, **1963**, *28*,592-593; b) M. H. Clausen, R. Madsen, *Chem. Eur. J*, **2003**, *9*, 3821-3832.
- [17] a) Y. Wang, W. M. Kalka-Moll, M. H. Roehrl, D. L. Kasper, *Proc. Natl. Acad. Sci, USA*, **2000**, *97*, 13478-13483; b) Y. H. Choi, M. H. Roehrl, D. L. Kasper, J. Y. Wang, *Biochemistry*, **2002**, *41*, 15144-15151; c) The  $^{13}\text{C}$  NMR-resonances of the native Sp1 polysaccharide were obtained from reported  $^{13}\text{C}$  NMR data in reference 16b and the  $^{13}\text{C}$  NMR value of methyl in  $\text{CH}_3\text{CONH-}$  as reference according to the  $^{13}\text{C}$  NMR value of dodecamer.
- [18] S. -S. Weng, *Tetrahedron Lett*, **2009**, *50*, 6414-6417.
- [19] V. Kumar, N. Taxak, . Jangir, P. V. Bharatam and K. P. R. Kartha, *J. Org. Chem*, **2014**, *79*, 3427-3439.
- [20] Muriel Compain-Batissou, Lamya Mesrari, Daniel Anker, Alain Doutheau, *Carbohydr. Res*, **1999**, *316*, 201-205.
- [21] D. Magaud, C. Grandjean, A. Doutheau, D. Anker, V. Shevchik, N. Cotte-Pattat, J. Robert-Baudouy, *Carbohydr. Res*, **1998**, *314*, 189-199.







## **Summary and Future prospects**

The work in this thesis has been focused on two subjects. The first is the assembly of alginate oligosaccharides and the generation of building blocks for the enzymatic synthesis of alginate, and the second is the total synthesis of large fragments of the zwitterionic SP1 polysaccharide. With these fragments, details about alginate biosynthesis can be obtained through binding studies with biosynthesis enzymes, conjugate vaccines can be generated and binding studies with major histocompatibility complex II molecules can be studied. This Chapter summarizes the work described in this Thesis and provides an outlook for future research.

## 8.1 Synthesis of alginate fragments and GDP-mannuronic acid building blocks

**Chapter 1** provides a concise overview of the synthesis of alginate oligosaccharides reported to date. So far, only alginate oligomers have been generated composed of a single type of building block, *i.e.*  $\beta$ -D-mannuronic acids or  $\alpha$ -L-guluronic acids. **Chapter 3** and **Chapter 4** describe the synthesis of alginate fragments containing both  $\beta$ -D-mannuronic and  $\alpha$ -L-guluronic acids. In **Chapter 3**, both monomeric and dimeric guluronic acid and glucose acceptors were synthesized and coupled with monomeric and dimeric donors to examine their reactivity in glycosylation reactions. It was found that the gulosyl C-4 hydroxyl is a relatively poor nucleophile. Quite surprisingly, the functional group at the C5, neighboring the C4-hydroxyl, had little influence on the reactivity of the nucleophile, with the guluronic acid acceptors performing similar to the glucose acceptors. A striking effect was found of the flexibility of the acceptor disaccharides. A  $\beta$ -O-mannuronic acid on the reducing end, equipped with a rigid spacer, led to a very poor nucleophile, while a flexible  $\alpha$ -configured 1-thio mannuronic acid reducing end residue provided a much more reactive acceptor. The conformational flexibility of  $\alpha$ -S-tolyl mannuronic acid reducing ends was reflected in the  $^1\text{H}$  NMR and  $^{13}\text{C}$  NMR spectra of the disaccharides, where the signals of the mannuronic acid ring appeared as broad and poorly resolved resonances at room temperature. At low temperature ( $-60\text{ }^\circ\text{C}$ ), two resonance sets became apparent that coalesced with increasing temperature. In **Chapter 4**, the fully stereoselective assembly of alginate fragments containing  $\beta$ -D-mannuronic and  $\alpha$ -L-guluronic acids has been reported for the first time. A set of alginate fragments, comprised of GM, GMG,

GMGM, GMGMG, GMGMGM, GMGMGMG and GMGGMG sequences was assembled. During the assembly of the oligomers the conformational flexibility of the GM acceptors was revealed as an all-important factor determining the efficiency of the coupling reactions. **Chapter 5** describes the assembly of a triad of guanosine diphosphate mannuronic acids, comprising GDP-ManA and its C-4-*O*-Methyl and C-4-deoxy congeners. These substrates for enzymatic alginate synthesis were assembled from the corresponding anomeric phosphates and a guanosine phosphoramidite building block. The target compounds were each generated in multi-milligram quantities. The GDP-ManA donors will be employed to fuel the mannuronic polymerase for the enzymatic assembly of polymannuronic acids. The generated C-4-capped and C-4-deoxygenated GDP-ManA donors will be explored as “chain stoppers” to gain control over the length of the growing polymannuronic acid chains.

The alginate biomachinery of *Pseudomonas aeruginosa* also incorporates acetyl groups on some of the mannuronic acid residues.<sup>[1]</sup> Therefore, it would be of interest to generate partially acetylated fragments to investigate binding of these to the biomachinery enzymes. Up to now, only de-acetyl alginate oligosaccharides have been synthesized and a logical extension of this work would be the assembly of partially acetylated fragments (the retrosynthesis is shown in Scheme 8.1). The flexible disaccharide acceptor **2** is chosen as key elongation unit to build oligosaccharide **5**, then remove temporary protecting group Nap to install Ac. After global deprotection, the spacer can be installed to generate target molecular.<sup>[2]</sup>

Scheme 8.1 The retrosynthesis of partially acetylated fragments of mannuronic acid alginate.

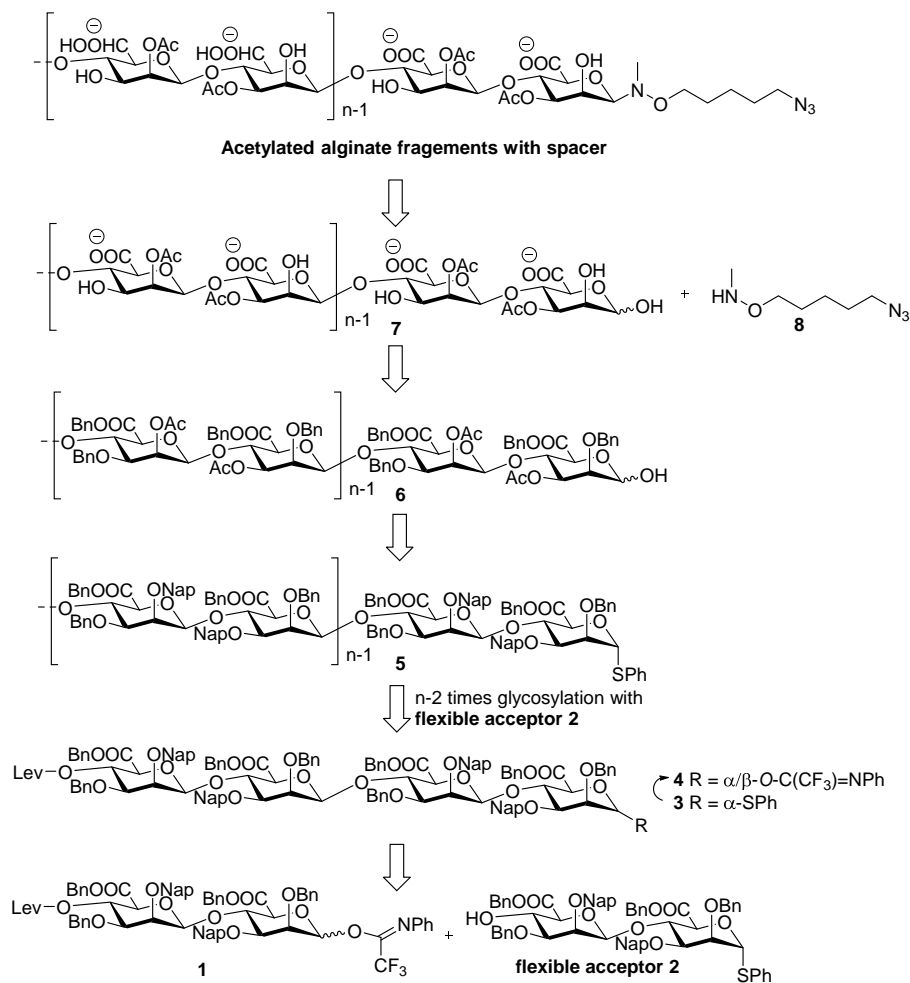

Sulfated oligomannuronic acid alginates (SOMAs) have been studied for their potential anti-cancer, anti-HIV activity and as mimics for heparin.<sup>[3]</sup> All these studies have been conducted with mixtures of compounds and the assembly of sulfated mannuronic acids, following the strategy outlined above (with the sole difference of incorporating sulfate esters in stead of acetyl esters) would therefore be of interest.

In the syntheses of the mixed sequence alginates, it has been found that the acceptors' flexibility is very important for a successful glycosylation.<sup>[4]</sup> It would be interesting to further study this phenomenon using different donors and different acceptors (of varying length). In future glycosylations involving poor nucleophiles, the acceptors' flexibility can be an important factor to consider when optimizing the reaction.

## 8.2 Synthesis of zwitterionic SP oligosaccharides

**Chapter 2** has provided a summary of the synthetic efforts undertaken so far in the assembly of zwitterionic polysaccharide fragments. These oligosaccharides all contain a glycuronic acid moiety. In **Chapter 6**, a new oxidation protocol for the selective oxidation of primary alcohol to carboxylic acids is introduced using a two-step one-pot TEMPO/BAIB-Pinnick oxidation sequence. This protocol was used in the oxidation of complex substrates, such a disaccharide synthon for the assembly of the *Staphylococcus aureus* Strain M Capsular Polysaccharide trisaccharide repeating unit and a SP1-model hexasaccharide fragment, that previously could not effectively be oxidized using the TEMPO/BAIB reagent combination. **Chapter 7**, reports the first synthesis of long zwitterionic Sp1 oligosaccharides. A Sp1-nonamer and dodecamer were assembled by combining a pre-glycosylation oxidation and post-glycosylation oxidation strategy. To guarantee complete stereoselectivity in the condensations of the trisaccharide building blocks, a silylidene galactose reducing end donor moiety was used. This required the simultaneous oxidation of three (for the nonasaccharide) or four (for the dodecasaccharide) primary alcohols at the end of the synthesis, which proved to be a major challenge. After the newly introduced TEMPO/BAIB-Pinnick oxidation protocol failed another improvement to the TEMPO/BAIB

oxidation system was found in the addition of sodium bicarbonate to the reaction mixture to speed up the conversion of the intermediately formed aldehydes into the carboxylic acids. A benzylation protocol employing phenyldiazomethane proved crucial to obtain the desired dodecasaccharide in good yield. The final zwitterionic **SP1** oligosaccharides were obtained in multi mg quantities. Structural analysis of the zwitterionic oligosaccharides using  $^1\text{H}$  NMR,  $^{13}\text{C}$  NMR and 2D-Noesy experiments revealed that the structure of the hexamer began to resemble the structure of the native SP1, while the spectra for the nonamer and especially the dodecasaccharide matched the spectra for the native polysaccharide even better. This may indicate that the longest oligosaccharides generated start to take up a secondary helical structure, as has been reported for the native polysaccharide. Further structural studies by NMR, combined with molecular modeling will provide more insight into the three-dimensional structure of the assembled oligosaccharides. This in turn, may provide insight to understand their biological activity.

The synthesis of the zwitterionic SP1 oligosaccharides, has presented a few bottlenecks. Besides the oxidation of multiple primary alcohols to corresponding carboxylic acid, the synthesis of the rare 2,4,6-tri-deoxy-2,4-diamino-galactose (TDDAG) building block proved to be challenging as well as the final deprotection step, in which the double bond of the butenol spacer was partly reduced under the birch reduction condition. To optimize the synthesis route and obtain longer zwitterionic SP1 oligosaccharides improvements can be made to the synthesis of the TDDAG synthon. For example, bulky protecting groups (such as the Piv, TBS, TIPS and TBDPS) can be used to mask the C3-alcohol of 6-deoxy-1-thio- $\beta$ -D-mannopyranoside to prevent the formation of the 2,4-diazido byproduct and prevent acetyl migration to the C4-nitrogen, upon removal of the

phthaloyl group. Also the nature of the nitrogen nucleophile in the second substitution reaction may be changed, to  $\text{NH}_3$  or  $\text{CbzNH}_2$ , for a more profitable outcome (Scheme 8.2).<sup>[5]</sup>

**Scheme 8.2** Synthesis of 2,4,6-trideoxy-galactose building block.

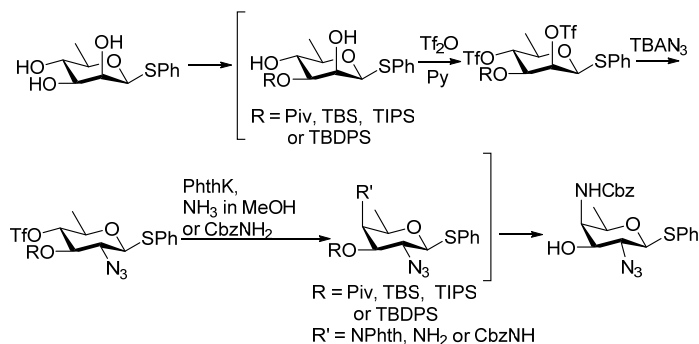

To further streamline the assembly of larger oligomers, the C3-levulinoyl ester on the TDDAG may be replaced by a benzyl ether. This will make the global deprotection scheme shorter and therefore more effective (see Scheme 8.3).

**Scheme 8.3** Synthesis of ZPS –SP1 oligosaccharides.

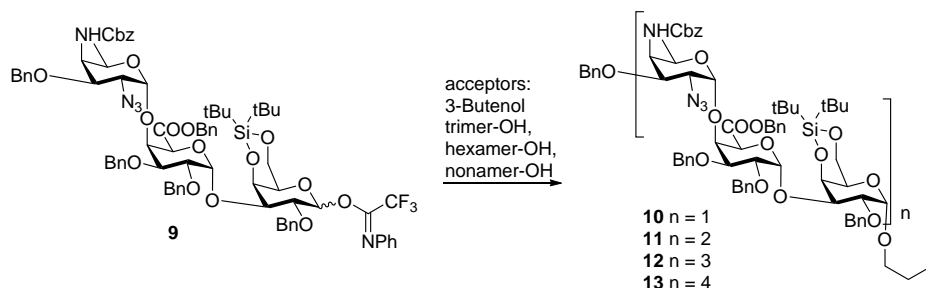

To prevent the difficult oxidation step at the end, a fully oxidized trisaccharide building block could be explored. For example, the trisaccharide uronic acid donor **14** could serve

as elongation unit to produce ZPS-oligosaccharides. The glycosylating properties of this building block will have to be established however as it is very likely that the generation of anomeric mixtures during the glycosylations will be a major problem. To investigate this type of coupling reaction, the monosaccharide and disaccharide uronic acid donor **15** and **16** can be investigated in the condensation with acceptor **17** (Figure 8.1). Donor **16** was shown to be a proper  $\alpha$ -selective donor in the coupling with phenyl 2-*O*-benzyl-4,6-di-*tert*-butylsilylidene-1-thio- $\beta$ -D-galactopyranoside, as described in Chapter 7.

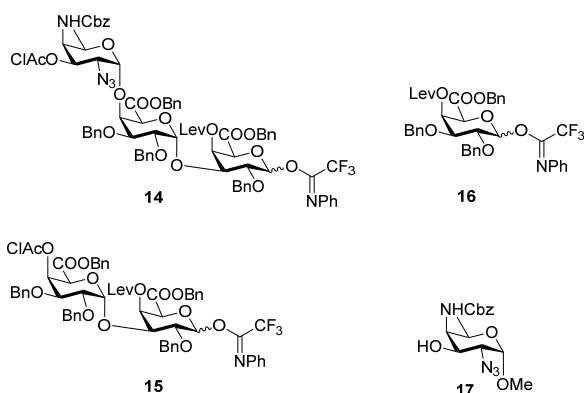
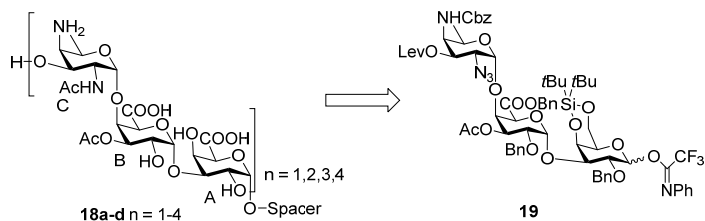

Figure 8.1 Pre-glycosylation oxidation strategy.

The naturally occurring capsular polysaccharide of *S. pneumoniae* type 1 is partly acetylated and it has been proposed that the C3-OH of the galacturonic acid residue B (see Scheme 8.4) carries the ester.<sup>[6]</sup> Therefore it would be of interest to synthesize these partly acetylated zwitterionic oligosaccharides **18** (for example a trimer, hexamer, nonamer and dodecamer). This could be accomplished using trisaccharide donor **19**. These oligosaccharides can then be studied for their 3D structure and biological activity. By



comparing them with the zwitterionic SP1 oligosaccharides lacking the acetate (compounds **1**, **2**, **3** and **4** in Chapter 7).



**Scheme 8.4** The structure of partly acetylated zwitterionic SP1 oligosaccharides.

### 8.3 References

- [1] G. SkjÅk-Bræk, H. Grasdalen, B. Larsen, *Carbohydr. Res*, **1986**, *154*, 239-250.
- [2] a) A. R. Prudden, L. Liu, C. J. Capicciotti, M. A. Wolfert, S. Wang, Z. Gao, L. Meng, K. W. Moremen, and G.-J. Boons, *Proc. Natl. Acad. Sci. U. S. A*, **2017**, *114*, 6954-6959; b) S. Munneke, J.R. C. Prevost, G. F. Painter, B. L. Stocker, M. S. M. Timmer, *Org. Lett.* **2015**, *17*, 624-627.
- [3] H. Ronghua, D. Yumin, Y. Jianhong, *Carbohydr. Polym*, **2003**, *52*, 19-24.
- [4] In chapter 3 and chapter 4.
- [5] A. R. Podilapu and S. S. Kulkarni, *Org. Lett*, **2017**, *19*, 5466-5469.
- [6] a) B. Lindberg, B. Lindqvex, J. Lönnnergern, D. A. Powel, *Carbohydr. Res*, **1980**, *78*, 111-117; b) R. C. E. Guy, M. J. How, M. Stacey, M. Heidelberger, *J. Biol. Chem*, **1967**, *242*, 5106-5111.



## Curriculum Vitae

Qingju Zhang was born in Biyang, Henan, China in November 1982. In 2004, he entered Xuchang University and obtained his bachelor degree of applied chemistry in 2008. Then, he moved to Zhengzhou University for master study in the field of organic chemistry. After following some courses and doing some research work under the supervision of Prof. Fuyi Zhang, he undertook his master research work in Prof. Biao Yu group at Shanghai Institute of Organic Chemistry, Chinese Academy of Sciences (under the supervision of Prof. Yu and Prof. Jiansong Sun) in 2009. He obtained master degree with the thesis 'The synthesis of sugar-fused isoxazoline-*N*-oxides and their application in producing amino-containing branched-chain saccharide derivatives and the synthesis of nucleosides via gold-catalyzed glycosylation' in 2011. He continued to do the research work (total synthesis of Amipurimycin) in Prof. Yu group as research assistant until March 2013.

The doctoral studies presented here commenced in April 2013 under the supervision of Prof. dr. G. A. van der marel and Dr. J. D. C. Codée in Bio-organic Synthesis group of Leiden University. Parts of his research work were presented as posters at CHAINS, the NWO-CW division Synthesis and Design in Veldhoven (2013-2016), and as poster presentation at Reedijk Symposium in 2016. One poster was presented at the 19<sup>th</sup> European Carbohydrate Symposium in 2017 (Barcelona, Spain). Oral presentation were given at Hangzhou Young Scholars Forum, Zhejiang University of Technology in 2017 (Hangzhou, China) and at Natinal Engineering Research Center for Carbohydrate Synthesis, Jiangxi Normal University in 2016 and 2017 (Nanchang, China). He also participated International Symposium on Organic Chemistry in 2016 (Wageningen, Netherlands), Wageningen National Organic Chemistry in 2017 (Wageningen, Netherlands) and 29<sup>th</sup> International Carbohydrate Symposium in 2018 (Lisbon, Portugal). From September 2017, he continue the research work as post doctoral under the supervision of Dr. S. I. van Kasteren, Prof. dr. G. A. van der marel and Dr. J. D. C. Codée in Bio-organic Synthesis group of Leiden University.

He was received "Chinese Government award" in 2017.

荣获“国家优秀自费留学生奖学金-2017”

The poster at 29<sup>th</sup> International Carbohydrate Symposium (ICS 2018) won both *Organic & Biomolecular Chemistry* Poster Prize: Vaccine and *Chemistry A European Journal* Poster Award.

## List of Publications

### **Total Synthesis, Structure analysis and Biological Studies of Zwitterionic SP1 Oligosaccharides**

*Manuscript in preparation*

### **Amipurimycin, total synthesis of the proposed structures and diastereoisomers**

Shengyang Wang, Jiansong Sun, Qingju Zhang, Xin Cao, Yachen Zhao, Gongli Tang and Biao Yu\*, *Angew. Chem. Int. Ed*, **2018**, *57*, 2884-2888.

### **Synthetic Zwitterionic Polysaccharides**

Qingju Zhang, Herman S. Overkleeft, Gijsbert A. van der Marel, and Jeroen D. C. Codée\*, *Current Opinion in Chemical Biology*, 2017, *40*: 95-101.

### **Synthesis of the Staphylococcus aureus strain M capsular polysaccharide repeating unit**

Bas Hagen, J. Hessel M. van Dijk, Qingju Zhang, Herman S. Overkleeft, Gijsbert A. van der Marel, Jeroen D. C. Codée\*, *Org. Lett*, **2017**, *19*, 2514-2517.

### **Chemical synthesis of guanosine diphosphate mannuronic acid (GDPMAN) and its C-4-O-methyl and C-4-deoxy congeners.**

Qingju Zhang, P. Lynne Howell, Herman S. Overkleeft, Dmitri V. Filippov, Gijsbert A. van der Marel, Jeroen D. C. Codée, *Carbohydr. Res*, **2017**, *450*, 12–18.

### **On the Reactivity of Gulose and Guluronic Acid Building Blocks in the Context of Alginate Assembly**

Qingju Zhang, Erwin R. van Rijssel, Marthe T. C. Walvoort, Herman S. Overkleeft, Gijsbert A. van der Marel, and Jeroen D. C. Codée\*, *Eur. J. Org. Chem*, **2016**, 2393-2397.

### **Acceptor Reactivity in the Total Synthesis of Alginate Fragments Containing $\alpha$ -L-Guluronic Acid and $\beta$ -D-Mannuronic Acid**

Qingju Zhang, Erwin R. van Rijssel, Marthe T. C. Walvoort, Herman S. Overkleeft, Gijsbert A. van der Marel, and Jeroen D. C. Codée\*, *Angew. Chem. Int. Ed*, **2015**, *54*, 7670-7673.

**An Efficient Approach to the Synthesis of Nucleosides, Gold(I)-Catalyzed N-Glycosylation of Pyrimidines and Purines with Glycosyl ortho-Alkynylbenzoates**

Qingju Zhang, Jiansong Sun\*, Yugen Zhu, Fuyi Zhang, Biao Yu\*, *Angew. Chem. Int. Ed.*, **2011**, *50*, 4933-4936.

**New Approach for the Synthesis of Sugar-containing Isoxaline-N-oxide**

Qingju Zhang, Jiansong Sun\*, Fuyi Zhang, Biao Yu\*, *Eur. J. Org. Chem.*, **2010**, 3579-3582.

**An Efficient Approach to the Synthesis of Nucleosides and their analogues**

Biao Yu, Jiansong Sun, Qingju Zhang, Yao Li, CN 102127135A. (Patent Application)

**Silica Phosphoric Acid: An Efficient and Recyclable Catalyst for the Solvent-free Synthesis of Acylals and Their Deprotection in MeOH**

Fuyi Zhang, Hong Liu, Qingju Zhang, Yu-Fen Zhao, Feng-Ling Yang. *Synth. Commun.*, **2010**, *40*, 3240-3250.