



Universiteit  
Leiden  
The Netherlands

## **Beyond relief : biomarkers of the anti-inflammatory effect and dose selection of COX inhibitors in early drug development**

Huntjens, D.R.H.

### **Citation**

Huntjens, D. R. H. (2008, November 18). *Beyond relief : biomarkers of the anti-inflammatory effect and dose selection of COX inhibitors in early drug development*. Retrieved from <https://hdl.handle.net/1887/13263>

Version: Corrected Publisher's Version

License: [Licence agreement concerning inclusion of doctoral thesis in the Institutional Repository of the University of Leiden](#)

Downloaded from: <https://hdl.handle.net/1887/13263>

**Note:** To cite this publication please use the final published version (if applicable).

# *Chapter 10*

## **Model-based prediction of the effect of COX inhibitors and optimal dosing in patients with systemic lupus erythematosus**

**Dymphy Huntjens, Giuliano Barissa, Eduardo Donadi, Vera Lanchote,  
Meindert Danhof and Oscar Della Pasqua**

*submitted for publication*

## ABSTRACT

**Purpose:** In the present study we investigate the exposure-response relationships for the inhibition of prostaglandin (PGE<sub>2</sub>) and thromboxane (TXB<sub>2</sub>) by fenoprofen in rats and healthy subjects *in vitro* and *in vivo* as biomarkers of the anti-inflammatory effect in patients with systemic lupus erythematosus (SLE).

**Methods:** The pharmacokinetic-pharmacodynamic analysis was based on nonlinear mixed effects modelling.

**Results:** IC<sub>80</sub> estimates for PGE<sub>2</sub> inhibition *in vitro* and *in vivo* were respectively, 25.9 vs 90.9 µg ml<sup>-1</sup> in rats and 21.5 vs 89.5 µg ml<sup>-1</sup> in healthy subjects. An identical effect was observed between healthy subjects and SLE patients. TXB<sub>2</sub> inhibition *in vitro* was similar in both species, but showed large differences *in vivo*. A two-fold difference was observed in IC<sub>80</sub> for SLE patients as compared to healthy subjects.

**Conclusions:** The anti-inflammatory dose of non-selective COX inhibitors can be derived from *in vitro* human data. Between-species differences *in vivo* may lead to biased estimates of the appropriate dose level.

## INTRODUCTION

The cardiovascular events observed a few years ago with rofecoxib have raised a major debate among clinical scientists and regulatory agencies about whether such events represented a class effect or were most likely to be caused by inappropriate dosing regimen of highly selective COX-2 inhibitors (1;2). Despite the ongoing debate on the risk-benefit ratio of cyclo-oxygenase inhibitors, it is surprising to see that limited effort has been made to correlate efficacy and safety findings to the underlying mechanism of action and evaluate in a quantitative manner whether the current rationale for the development of anti-inflammatory drugs yields accurate recommendation for a dosing regimen (3-5). This is particular important, given the evidence from new drug applications (NDAs) and market authorisation approvals (MAAs), indicating that Phase IIB dose-ranging studies are often poorly designed (6-8).

Rational drug therapy is based on the assumption that there is a causal relationship between dosing regimen or drug exposure and the observed therapeutic response as well as adverse effects. Hence, it has been one of the major goals of clinical pharmacology to find systematic ways to identify the appropriate dosing regimens as early as possible during drug development (9). An important question that remains to be answered is how much and how long COX-2 and COX-1 should be inhibited to ensure an optimal risk-benefit ratio, allowing for sustained analgesic, anti-inflammatory response and appropriate safety margin. This question is very pertinent to the assessment of long-term effects, particularly if one considers that continued suppression of COX-2 has implications for normal tissue repair (10-12). To date, the dose selection of COX inhibitors has been based primarily on clinical endpoints for analgesia, an approach which disregards the impact of maximum, long-lasting blockade of either enzyme systems (13). The nature and complexity of the interaction between various factors that determine the analgesic response of COX inhibitors require biomarkers to explain and understand variability in the treatment effect. The use of a biomarker in pain measurements is an important step in the development of new COX inhibitors, as it can link pharmacokinetics to the analgesic effect and eventually provide a proxy for safety evaluation. Moreover, it should enable extrapolation from pre-clinical findings *in vitro* and *in vivo* yielding earlier and more accurate prediction of first dose estimation in phase I studies. In fact, we have recently developed a pharmacokinetic-pharmacodynamic (PKPD) model to quantitatively analyse the inhibition of TXB<sub>2</sub> and PGE<sub>2</sub> by naproxen *in vitro* and *in vivo* in rats and healthy subjects (14).

In the current investigation we propose a model-based approach to guide dose selection of a non-selective COX inhibitor (fenoprofen) in a chronic disease condition (systemic lupus erythematosus), which takes into account drug effect on biomarkers of inflammation. We illustrate the importance of biomarkers in the assessment of the anti-inflammatory effect and show how data from pre-clinical experiments and early clinical studies may be used to predict the effective dosing regimen in patients.

In analogy to rheumatoid arthritis, systemic lupus erythematosus (SLE) is also a multisystem, chronic autoimmune disease which requires long-term treatment with anti-inflammatory drugs. Because the

disease varies in severity and can affect major organ systems, patients should be monitored carefully for organ damage and medication toxicity. Nearly 80% of patients with SLE are treated with non-steroidal anti-inflammatory drugs (NSAIDs) for fever, arthritis, serositis and headaches (15). Ibuprofen, naproxen and fenoprofen, 2-arylpropionic acid derivatives, are often prescribed off-label to SLE patients at doses of 400, 500 and 300-600 mg per intake, respectively. Whilst claims also exist for the potential nephroprotective effect of COX inhibitors in SLE patients, drug-induced acute renal failure may occur due to long-term use of anti-inflammatory agents (15). This scenario highlights the importance of markers of pharmacological activity for achieving optimal balance between risk and benefit, i.e., accurate dosing recommendation.

## MATERIALS AND METHODS

The current investigation includes results from a study in which biomarkers of COX-inhibition were determined *ex vivo* after a single oral dose of fenoprofen to rats, healthy subjects and SLE patients. In addition, data from *in vitro* experiments were obtained from rats and healthy subjects to assess *in vitro-in vivo* correlations within and across species.

*Animal experiments.* Two experiments were performed in male Sprague-Dawley (SD) rats (Charles River B.V., Maastricht, The Netherlands) weighting  $281 \pm 4$  g (Mean  $\pm$  SEM, n=22). All experiments were approved by the Ethical Committee on Animal Experimentation of the University of Leiden. Fenoprofen (Trandor, Lilly, Indianapolis, USA) was administered in both experiments as an i.p. bolus at a dose of  $18 \text{ mg kg}^{-1}$  dissolved in PEG400/saline (4:6).

In the first experiment cannulated animals (study 1, n=10 rats) were used to allow frequent blood sampling for the analysis of the pharmacokinetics of fenoprofen. Details of the experimental conditions and surgical procedures for animal cannulation have been described previously by Huntjens et al (14). Serial arterial blood samples (400  $\mu$ l) were taken at pre-defined time points (0, 0.08, 0.17, 0.33, 1, 2, 3, 4, 5, 6, 9, 12, 15, 18, 21, 24 and 32 hours after i.p. administration). The number of blood samples was fixed to seven per animal, according to a randomised sampling schedule. Blood samples were immediately heparinised and centrifuged at 5000 rpm for 10 min for plasma collection and stored at  $-20^{\circ}\text{C}$  until analysis. The same volume of collected blood was reconstituted with physiological saline solution.

In the second experiment tail vein samples (150  $\mu$ l) were collected to assess the pharmacodynamics of fenoprofen and subsequent PKPD modelling of  $\text{TXB}_2$  and  $\text{PGE}_2$  inhibition (study 2, n=12 rats). Sampling was limited up to a total of seven samples per animal. In addition to six post-dose samples, a blood sample for the determination of the baseline levels of  $\text{PGE}_2$  and  $\text{TXB}_2$  was taken between 15 and 45 min prior to drug administration. In order to characterise the thorough time course of the pharmacodynamic effects, experiments were started in the morning (08.00 a.m.) or in the evening (06.00 p.m.). Seven post-dose samples were taken for the experiments started in the morning between 01-0.7h (sample 1), 3.0-3.5h (sample 2), 6 - 7h (sample 3), 9 -10 h (sample 4), 12-13 h (sample 5) and 24 -25 h (sample 6) and 32-33 h (sample 7). Six post-dose samples were taken for

the experiments started in the evening between 0.1-0.7 h (sample 1), 14.-15 h (sample 2), 17-18 h (sample 3), 21 -22 (sample 4), 24-25 h, (sample 5) and 39-40h (sample 6). Blood samples were split into aliquots of 100  $\mu\text{l}$  (for  $\text{PGE}_2$ ) and 50  $\mu\text{l}$  (for  $\text{TXB}_2$ ). Blood samples for  $\text{TXB}_2$  analysis were placed into tubes and allowed to clot for 1 hour at  $37^\circ\text{C}$  in a stirring water bath. Serum was collected after centrifugation and stored at  $-20^\circ\text{C}$  until analysis. Tubes for the analysis of  $\text{PGE}_2$  were prepared by evaporating aspirin ( $10 \mu\text{g ml}^{-1}$  in methanol and heparin (10 I.U.) Blood samples were placed in tubes and  $10 \mu\text{g ml}^{-1}$  lipopolysaccharide (LPS) was added. Samples were incubated and stirred for 24 hours at  $37^\circ\text{C}$  in a water bath. Plasma was separated by centrifugation and stored at  $-20^\circ\text{C}$  until analysis. Blood samples for drug concentrations could not be obtained for study 2, due to the plasma volume requirements for the HPLC analysis.

*Healthy subjects and SLE patient study.* Ten healthy subjects (5 male and 5 female) were enrolled for this study. Subjects were non-obese, non-smokers, and presented hepatic, renal, and cardiac functions within normal range. Fourteen SLE patients were enrolled with varying renal function (table 1). All individuals received detailed information about the study and gave written informed consent to participate in the investigation. The study protocol was approved by the Research Ethics Committee of HCFMRP-USP, University of Sao Paulo, Brazil.

Briefly, all subjects received a single 600 mg dose of racemic calcium fenoprofen in the form of capsules with 200 ml of water after a 12-hour fasting period. Breakfast was served 2 h after administration of the drug. Blood samples (approximately 10 ml) were collected into heparinised syringes (LiquemineR, 5000 UI, Roche, Sao Paulo, Brazil) at 0, 15, 30, and 45 min and at 1, 1.5, 2, 3, 4, 6, 8, 10, 12, 14, and 24 h after dosing. An aliquot of 2 ml blood was placed in tubes with no anticoagulant and kept at  $37^\circ\text{C}$  for 1 hour for clot formation. The supernatant was then centrifuged for 10 minutes at 1800g, and the serum obtained was stored at  $-70^\circ\text{C}$  until the time for analysis of  $\text{TXB}_2$  concentration. A second aliquot of 3 ml blood were transferred to tubes containing 3.8% sodium citrate and immediately incubated with LPS for 24 hours. After incubation, samples were centrifuged and plasma stored at  $-70^\circ\text{C}$  for the analysis of  $\text{PGE}_2$ . The remaining blood volume (approximately 5 mL) was centrifuged with 3.8% sodium citrate for 10 minutes at 1800g for the analysis of pharmacokinetics of fenoprofen. Plasma was separated after centrifugation and stored at  $-70^\circ\text{C}$  until the time for analysis.

*In vitro experiments in rats and healthy subjects.* For the *in vitro* experiments in rats, blood from six male SD rats was collected via the right jugular vein. The surgical procedure was performed under anaesthesia with  $0.1 \text{ mg kg}^{-1}$  i.m. of medetomidine hydrochloride (Domitor, Pfizer, Capelle a/d IJssel, The Netherlands) and  $1 \text{ mg kg}^{-1}$  s.c. of ketamine base (Ketalar, Parke-Davis, Hoofddorp, The Netherlands). Samples were separated into aliquots of 100  $\mu\text{l}$  for  $\text{PGE}_2$  and 50  $\mu\text{l}$  for  $\text{TXB}_2$  determination. Prior to the *in vitro* experiment, tubes were prepared by evaporating fixed amounts of fenoprofen (0, 0.25-200  $\text{ng ml}^{-1}$  for rats and or 0, 0.05-400  $\text{ng ml}^{-1}$  for healthy subjects) in methanol. Evaporated heparin (10 I.U.) and aspirin ( $10 \mu\text{g ml}^{-1}$ ) in methanol was also added into the tubes for  $\text{PGE}_2$  analysis. Blood samples for  $\text{TXB}_2$  analysis were placed into tubes and allowed to

clot for 1 hour at 37°C in a stirring water bath. Serum was collected after centrifugation and stored at -20°C until analysis. Blood samples for the analysis of PGE<sub>2</sub> were placed in tubes and 10 µg ml<sup>-1</sup> LPS was added. Samples were incubated for 24 hours at 37°C in a stirring water bath. Plasma was separated by centrifugation and stored at -20°C until analysis.

For the *in vitro* experiments in healthy subjects (n=6), peripheral venous blood samples were collected by venous puncture of the cubital vein. Informed consent was obtained from the seven subjects enrolled in the study. The subjects were between 23 and 30 years of age and had a weight range within 30% of their ideal body weight. The subjects had an unremarkable medical history and were normal in routine haematological and biochemical studies. Smokers and subjects with a bleeding disorder, an allergy to aspirin or any other NSAIDs, or a history of any gastrointestinal disease were excluded. Subjects abstained from the use of aspirin and other NSAIDs for at least two weeks before enrolment. Samples were separated into aliquots of 1 ml for PGE<sub>2</sub> and 1 ml for TXB<sub>2</sub> quantification. Experimental assay and analytical procedures were performed as described above.

**Table 1.** Demographics for healthy subjects and SLE patients. Data reported as mean ± stdev.

	<b>N</b>	<b>Gender</b>	<b>Age (years)</b>	<b>Weight (kg)</b>	<b>Height (cm)</b>	<b>Renal function*</b>
Healthy subjects	10	5 Males / 5 Females	26±4	66±10	171±7	0: 100%
SLE patients	14	1 Male / 13 Females	32±8	62±17	158±10	1: 14%
						2: 21%
						3: 36%
						4: 29%

**Biomarker analysis.** PGE<sub>2</sub> and TXB<sub>2</sub> were measured by a validated enzyme immunoassay (EIA) (Amersham Biosciences Europe GmbH, Freiburg, Germany) and samples were prepared as described previously (14).

**Enantioselective analysis of fenoprofen in plasma.** Plasma concentrations of fenoprofen were measured using a validated high performance liquid chromatography (HPLC) method, as described previously (16). Briefly, Briefly, 25 µl of the internal standard solution (phenacetin, 10 µg), 25 µl hydrochloric acid (1 Mm) and 6 ml of a mixture of n-pentane and dichloromethane (1:1, volume/volume) as the extracting solvent were added to 200-500 µL plasma aliquots. After extraction in a mixer for 2 minutes (1000 cycles/min) and centrifugation for 5 minutes at 1800g, the organic phases were transferred to conical tubes and evaporated under an air flow at room temperature and the residues reconstituted with 200 µl of the mobile phase. Volumes of 100 µl were used for chromatographic analysis. The high performance liquid chromatography (HPLC) system consisted of a Shimadzu liquid chromatographer (Kyoto, Japan) equipped with an LC-10 AD pump, an SPD-10A UV-visible absorption detector operating at 273 nm wavelength, and a CR-6A integrator. A model 7125 Rheodyne injection system (Cotati, CA, USA) with a 100-µl loop was used. The fenoprofen enantiomers were separated on a 4.6 250-mm Chiralpak AD column (Dialcel Chemical Industries LTD, Los Angeles, Calif) with 10-µm particles, and the mobile phase consisted of a mixture

of n-hexane/isopropylalcohol/trifluoroacetic acid, (91.5:8.4:0.1, volume/volume/volume) with a flow of  $1.2 \text{ ml min}^{-1}$ . The enantiomers were extracted from plasma with a recovery of more than 70%. The quantitation limit was  $0.6 \mu\text{g ml}^{-1}$ . The coefficients of variation obtained for inter- and intra-assay precision were lower than 15%.

*Data analysis.* The pharmacokinetics and pharmacodynamic effects of fenoprofen were assessed by non-linear mixed effects modelling, as implemented in NONMEM version V, level 1.1 (Globomax, Ellicott City, USA). Final model parameters were estimated by the first order conditional estimation method with  $\eta$ - $\epsilon$  interaction (FOCE interaction). This approach allows the estimation of inter- and intra-individual variability in model parameters. All fitting procedures were performed on a computer (AMD-Athlon XP-M 3000+) running under Windows XP with the Fortran compiler Compaq Visual Fortran version 6.1. An in-house interface for S-Plus 6.0 (Insightful Corp., Seattle, WA, USA) - NONMEM was used for data processing, management and graphical display.

*Pharmacokinetic analysis.* Multiple compartmental models were tested for R and S-fenoprofen. Model selection and identification was based on the likelihood ratio test, parameter point estimates and their respective 95% confidence intervals, parameter correlations and goodness-of-fit plots. For the likelihood ratio test, the significance level was set at 0.01, which corresponds with a decrease of 6.63 points, after the inclusion of one parameter, in the minimum value of the objective function (MVOF) under the assumption that the difference in MVOF between two nested models is  $\chi^2$  distributed. The following goodness-of-fit plots were subjected to visual inspection to detect systemic deviations from the model fits: individual observed vs. population or individual predicted values and weighted residuals vs. time or population predicted values.

In rats and humans, R-fenoprofen undergoes unidirectional biotransformation to the active S-enantiomer (17). The extent of interconversion is greater in humans than in rats (18). Pre-systemic inter-conversion already takes place in GI tract and systemic inter-conversion occurs in the liver (19). In rats, only S-Fenoprofen concentrations could be used for the pharmacokinetic analysis, as almost all R-fenoprofen concentrations were below the detection limit of the assay. Therefore, the population pharmacokinetic model was built based on prior knowledge of the interconversion and S-fenoprofen concentrations. Based on model selection criteria, S-Fenoprofen exposure in rats was described by a two compartment model (figure 1) with zero and first order processes for absorption. The first order process describes the normal absorption of S-fenoprofen and the zero order process describes additional input of the conversion of R to S-fenoprofen. As chiral conversion already starts pre-systemically, time lag was fixed at 10 seconds. The pharmacokinetic analysis was performed using the ADVAN2 TRANS2 subroutine in NONMEM. In humans, data from both enantiomers were included in the analysis. A four-compartment model was used to describe the pharmacokinetics and chiral conversion from R to S-enantiomer (figure 1). Compartments 1 and 2 represent disposition compartments for R-fenoprofen, whereas compartments 3 and 4 reflect the disposition of S-fenoprofen. Chiral conversion from R to S-fenoprofen was described by the rate constant  $K_{RS}$ . The analysis was performed using the ADVAN6 subroutine in NONMEM.



Variability in pharmacokinetic parameters was assumed to be log-normally distributed in the population. Therefore an exponential distribution model was used to account for inter-individual variability:

$$P_i = \theta_i \cdot \exp(\eta_i) \quad (1)$$

where  $\theta$  is the population estimate for parameter  $P$ ,  $P_i$  is the individual estimate and  $\eta_i$  is the normally distributed between-subject random variable with mean zero and variance  $\omega^2$ . The coefficient of variation (CV %) of the structural model parameters is expressed as percentage of the root mean square of the inter-individual variance term. Selection of an appropriate residual error model was based on the inspection of the goodness-of-fit plots. Hence, a combination of a proportional and an additive error model was proposed to describe residual error in the plasma drug concentration in the human data, but only a proportional error model in rats:

$$C_{obs,ij} = C_{pred,ij} \cdot (1 + \varepsilon_{ij,1}) + \varepsilon_{ij,2} \quad (2)$$

where  $C_{obs,ij}$  is the  $j^{\text{th}}$  observed concentration in the  $i^{\text{th}}$  individual,  $C_{pred,ij}$  is the predicted concentration, and  $\varepsilon_{ij}$  is the normally distributed residual random variable with mean zero and variance  $\sigma^2$ . The residual error term contains all the error terms that cannot be explained by other fixed effects including experimental error (e.g. error in recording sampling times) and structural model misspecification.

Covariate factors were screened by univariate analysis in NONMEM. After the analysis, covariates were incorporated into the model using a stepwise forward inclusion procedure. A covariate was deemed statistically significant if a reduction in the objective function by more than 6.63 was

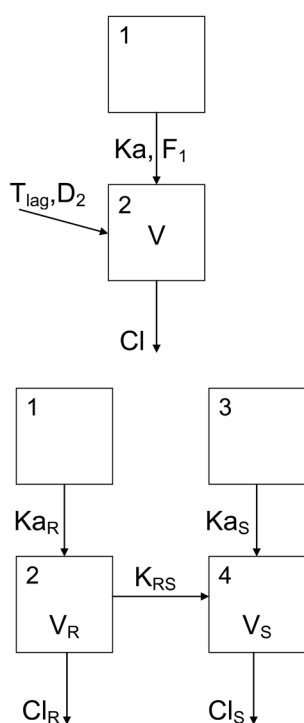

**Figure 1.** Schematic representation of the pharmacokinetic model for fenopufen in rats and humans. Upper plot shows model for pharmacokinetics in rats. Lower plot shows model for pharmacokinetics in humans. Upper plot: Compartment (CMT) 1 is depot compartment for S-fenopufen after i.p. dosing. Lower plot: CMT1 is for R-fenopufen, CMT3 is for S-fenopufen dosing after oral administration.

observed upon inclusion of the covariate into the model. After completion of covariate search, the stability of the full model was evaluated by subtracting each covariate individually (backward elimination). Covariates were kept into the final model only when the objective function was reduced by more than 3.84 after removal of the covariate.

A visual predictive check was used to assess whether the simulated concentration time profiles are consistent with the observed data and reflect between-subject individual variability accordingly. The predictive performance of the pharmacokinetic model was evaluated using 1000 data sets based on the final model parameter estimates. The mean and the 95 % confidence interval were calculated from the simulated fenoprofen concentrations at the pre-defined time-points.

*Pharmacodynamic analysis.* In this study, PGE<sub>2</sub> and TXB<sub>2</sub> concentrations were used as a measure of drug response. The sigmoid I<sub>max</sub> model (equation 3) was used to relate plasma concentrations (C) to drug response by the equation:

$$Effect = I_0 - (I_0 - I_{max}) * (C^n / (C^n + IC_{50}^n)) \quad (3)$$

where I<sub>max</sub> represents the maximal inhibitory response to fenoprofen, I<sub>0</sub> the baseline production of PGE<sub>2</sub> or TXB<sub>2</sub> and n the Hill factor. This equation is an adaptation from the E<sub>max</sub> model to obtain the inhibition level in percentage directly from the absolute values for I<sub>0</sub> and I<sub>max</sub>. The sigmoid I<sub>max</sub> model was used for the analysis of the data in rats and humans (healthy subjects and SLE patients) *in vitro* and *in vivo*.

The sigmoid I<sub>max</sub> model was used for data analysis of the *in vitro* data in rats and healthy subjects. In rats, however, a correlation between I<sub>0</sub> and TXB<sub>2</sub> or PGE<sub>2</sub> production without drug administration was observed and described by the following equation:

$$I_0 = \theta_i + \theta_j * (\text{Blank\_biomarker} - \text{median blank biomarker}) \quad (4)$$

where I<sub>0</sub> is the baseline TXB<sub>2</sub> or PGE<sub>2</sub> production,  $\theta_i$  and  $\theta_j$  are intercept and slope of model parameter I<sub>0</sub> versus blank TXB<sub>2</sub> or PGE<sub>2</sub> production relationship, respectively. We have not found a correlation between baseline levels and TXB<sub>2</sub> or PGE<sub>2</sub> production in human blood.

*Simulations.* An important question is whether one can predict analgesic dose based on biomarker inhibition data *in vitro/in vivo* from (pre)-clinical data. To address these questions, simulations were conducted. A dosing regimen with q4d administration (100-1000 mg per intake, were simulated at steady state. Simulations were conducted based on the pharmacokinetic model in SLE patients. Population parameter estimates obtained from the 4 pharmacodynamic models (human *in vitro*, human *in vivo*, rat *in vitro* and rat *in vivo*) for PGE<sub>2</sub> and TXB<sub>2</sub> inhibition were used for the PKPD simulations. At steady state, time above 80% inhibition was calculated for each of the PKPD models. The inhibition of 80% is directly correlated with the therapeutic analgesic plasma concentration (13) and therefore a suitable marker in the comparison of efficacy based on the different models.

*Statistical test.* Unpaired student's test was used for comparison between groups of *in vitro* and *in*

*vivo* data  $p < 0.05$  was considered statically significant.

## RESULTS

**Baseline biomarkers.** *In vitro* LPS-induced PGE<sub>2</sub> production averaged  $110 \pm 48$  ng ml<sup>-1</sup> and  $48 \pm 16$  ng ml<sup>-1</sup> (mean  $\pm$  stdev,  $n=6$ ) for rats and healthy subjects, respectively, whereas whole blood TXB<sub>2</sub> levels averaged  $650 \pm 400$  ng ml<sup>-1</sup> and  $218 \pm 94$  ng ml<sup>-1</sup> for rats and healthy subjects respectively. Baseline values of both biomarkers showed statistically significant differences between species ( $p < 0.05$ ).

*In vivo* LPS-induced PGE<sub>2</sub> production averaged  $9.16 \pm 6.64$  ng ml<sup>-1</sup> and  $4.25 \pm 4.18$  ng ml<sup>-1</sup> for healthy subjects and SLE patients, respectively, whereas whole blood TXB<sub>2</sub> levels averaged  $862 \pm 206$  ng ml<sup>-1</sup> and  $821 \pm 318$  ng ml<sup>-1</sup> for healthy subjects and SLE patients, respectively. Baseline values of both biomarkers in SLE patients did not differ significantly from healthy subjects ( $p > 0.05$ ). In rats LPS-induced PGE<sub>2</sub> production and TXB<sub>2</sub> levels averaged  $104 \pm 44$  ng ml<sup>-1</sup> and  $592 \pm 208$  respectively. Baseline values of both biomarkers showed statistically significant differences between species ( $p < 0.05$ ) No significant differences were observed between baseline values for the *in vivo* data from healthy subjects and patients ( $p < 0.05$ ).

***In vitro-in vivo correlations.*** *In vitro* and *in vivo* baseline levels for PGE<sub>2</sub> and TXB<sub>2</sub> production in rats were not significantly different ( $p < 0.05$ ). On the other hand, *in vitro* and *in vivo* baseline levels for PGE<sub>2</sub> and TXB<sub>2</sub> production in healthy subjects were significantly different ( $p > 0.05$ ).

**Biomarker modelling *in vitro*.** The *in vitro* concentration-effect relationship for PGE<sub>2</sub> and TXB<sub>2</sub> inhibition in rats and humans was modelled by an inhibitory I<sub>max</sub> model (figure 2, table 2). A significant correlation was observed between I<sub>0</sub> and baseline TXB<sub>2</sub> and PGE<sub>2</sub> production in rats ( $p < 0.001$ ). By introducing baseline effect as covariate, MVOF was decreased by -21 for PGE<sub>2</sub> inhibition and -17 for TXB<sub>2</sub> inhibition. All structural and stochastic parameters of the final model are presented in Table 2. As indicated by the CV%, all parameters were accurately estimated and inter-individual variability was found on the IC<sub>50</sub> estimates for PGE<sub>2</sub> in humans and on TXB<sub>2</sub> inhibition in rats. Interestingly, IC<sub>50</sub> and IC<sub>80</sub> values (table 6) values are comparable between rats and humans for PGE<sub>2</sub> inhibition ( $10500$  ng ml<sup>-1</sup> versus  $11200$  ng ml<sup>-1</sup> for rats and humans for IC<sub>50</sub> and  $25983$  ng ml<sup>-1</sup> versus  $21538$  ng ml<sup>-1</sup> for rats and humans for IC<sub>80</sub>, respectively,  $p < 0.05$ ), but significantly different for TXB<sub>2</sub> inhibition ( $8350$  ng ml<sup>-1</sup> versus  $1590$  ng ml<sup>-1</sup> for rats and humans and  $33400$  ng ml<sup>-1</sup> versus  $4778$  ng ml<sup>-1</sup> for rats and humans for IC<sub>80</sub>, respectively,  $p > 0.05$ ). Maximum inhibitory levels were higher than 93.8% for PGE<sub>2</sub> inhibition in rats and more than 99% in rats and healthy subjects.

**Pharmacokinetic modelling of fenopufen in rats.** A pharmacokinetic experiment was conducted in a satellite group of animals to accurately estimate pharmacokinetic parameters and obtain the concentration time course of fenopufen in the subsequent PKPD analysis. Due to blood sample volume restrictions, pharmacokinetic and biomarker data could not be obtained from the same set of animals. The time course of S-fenopufen in plasma after i.p. administration of fenopufen

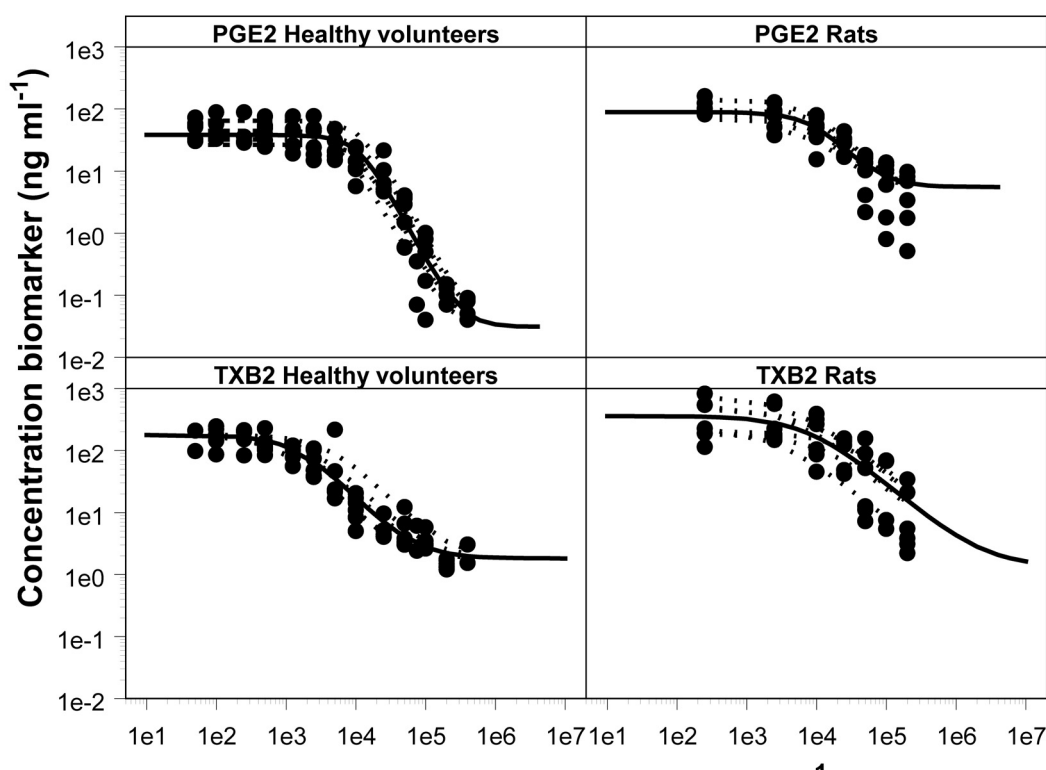

**Figure 2.** Pharmacodynamics of fenopfen *in vitro*. Upper panel: fenopfen concentrations versus PGE<sub>2</sub> inhibition. Lower panel: fenopfen concentrations versus TXB<sub>2</sub> inhibition. Solid symbols represent individual data points. Solid black line indicates the population prediction, dashed lines represent individual predictions.

**Table 2.** Population pharmacodynamic estimates for the *in vitro* inhibitory effects of fenopfen on PGE<sub>2</sub> and TXB<sub>2</sub> production in rats and healthy subjects. Values in parentheses are relative standard errors (%) of the estimates.

Parameter	Parameter estimate	IIV*	Parameter estimate
<i>PGE<sub>2</sub> inhibition</i>			
<i>Fixed effects</i>		Rats	Healthy subjects
$I_0$ (ng mL <sup>-1</sup> )			
$\theta_{\text{Intercept}}$	89.4 (8)		30 (54)
$\theta_{\text{Slope}}$	0.706 (19)		
IC <sub>50</sub> (ng mL <sup>-1</sup> )	10500 (7)		29 (32)
Hill coefficient	1.53 (6)		2.12 (12)
$I_{\text{max}}$ (ng mL <sup>-1</sup> )	5.53 (21)		0.0309 (31)
Proportional error (%)	41 (41)		37 (23)
<i>TXB<sub>2</sub> inhibition</i>			
<i>Fixed effects</i>		Rats	Healthy subjects
$I_0$ (ng mL <sup>-1</sup> )			
$\theta_{\text{Intercept}}$	359 (10)		178 (14)
$\theta_{\text{Slope}}$	0.575 (22)		
IC <sub>50</sub> (ng mL <sup>-1</sup> )	8350 (45)	79 (65)	1590 (63)
Hill coefficient	1 (-)		1.26 (24)
$I_{\text{max}}$ (ng mL <sup>-1</sup> )	1.33 (-)		1.82 (19)
Proportional error (%)	57 (24)		44 (26)

racemate is displayed in figure 3. Standard compartment models were tested and compared to the final model with zero order absorption for the unidirectional conversion of R to S-fenoprofen. The final model was significantly better than a standard two compartment model ( $p < 0.05$ ). However, inter-individual variability could not be estimated for any of the structural parameters (table 3). In addition, clearance was fixed at  $0.08 \text{ ml min}^{-1}$  based on a previous publication by Poggi *et al.* (20).

*Pharmacokinetic modelling of fenoprofen in healthy subjects and SLE patients.* The population prediction, individual predictions and individual data points of R- and S-fenoprofen are displayed in figure 4. All parameters were accurately estimated as presented by their CV% (table 4). The posterior predictive check showed model stability and consistency, as indicated by an accuracy prediction of  $>95\%$  of the measured fenoprofen plasma concentrations over time. Inter-individual variability was found on both central volume of distributions of the enantiomers and on clearance of S-fenoprofen. Intra-individual variability was characterised by an additive and a proportional component. The additive residual error was fixed at  $0.3 \text{ g ml}^{-1}$  based on limit of quantification of the HPLC assay. The only significant covariate was the disease status on the parameter  $V_R$  and disease status was determined to have a 39% reduction in  $V_R$  compared to healthy subjects. The half life of R-fenoprofen was estimated at 33 min, whereas S-fenoprofen half life was determined at 4.2 hr for SLE patients and 6.9 hr for healthy subjects. The conversion clearance  $Cl_{RS}$  was determined at  $10.0 \text{ l hr}^{-1}$ , which is 2-4 times as rapid as the elimination of both enantiomers.

*Biomarker modelling in vivo.* The concentration-biomarker relationships for rats and humans are

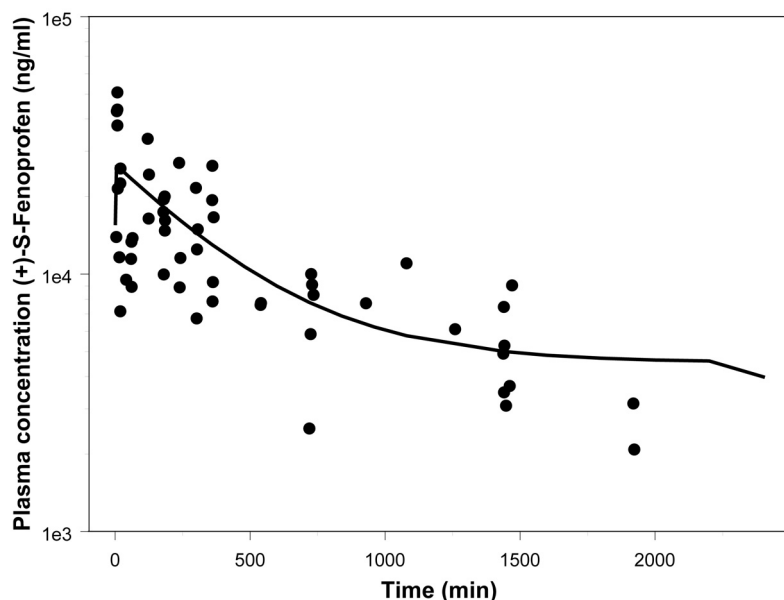

**Figure 3.** Population pharmacokinetic profiles of fenoprofen ( $18 \text{ mg kg}^{-1} \text{ i.p.}$ ) in rats. Solid symbols represent individual data points. Solid black line indicates population prediction.

shown in figures 5 and 6, respectively. Given the impossibility to obtain sufficient blood volume for the determination of pharmacokinetics in the PKPD experiments in rats, the population predicted concentration time course of fenoprofen was used as input for modelling of the biomarker inhibition *in vivo*. On the other hand, individual predicted concentration values were used for modelling of the human data *in vivo*.

All structural parameters were estimated with accurate precision as demonstrated by their CV%

**Table 3.** Population pharmacokinetic estimates for fenoprofen in rats. Values in parentheses indicate coefficient of variation (%).

Final Model Estimates Fenoprofen	
	<i>Fixed effects</i>
Cl (mL/min)	0.08 <sup>†</sup> (-)
V/F (mL)	29.8 (34)
Ka (min <sup>-1</sup> )	0.893 (42)
Duration (min)	2350 (28)
F1 (%)	16 (42)
F2 (%)	17 (28)
Residual variability	
Proportional error (%)	44 (23)

(table 5). In rats, maximum TXB<sub>2</sub> and PGE<sub>2</sub> inhibition was fixed to the values estimated *in vitro*. Inter-individual variability was identified on most fixed effect parameters, such as Hill coefficient and potency.

The potency of fenoprofen showed statistically significant differences between rats and humans. IC<sub>50</sub>

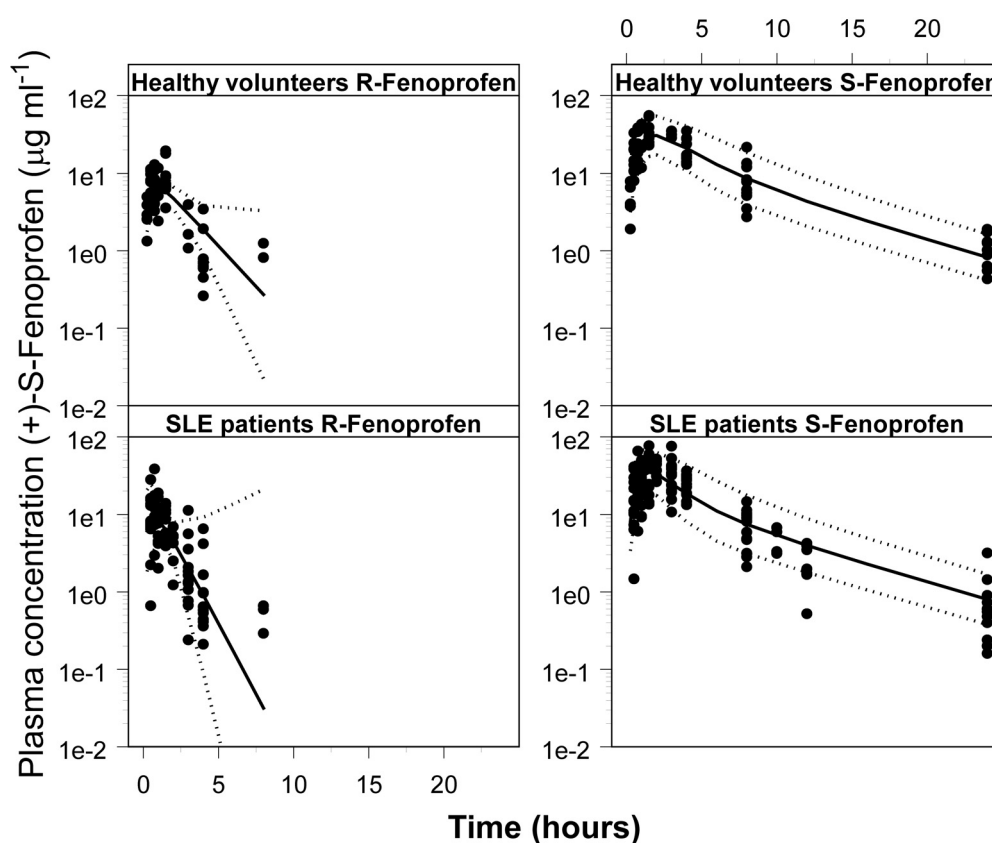

**Figure 4.** Population pharmacokinetic profiles of both enantiomers of fenoprofen (600 mg) in healthy subjects and SLE patients. Solid symbols represent individual data points. Solid black line indicates population prediction, dashed lines represent 5% and 95% confidence intervals. Left graphs represent R-Fenoprofen and right graphs S-Fenoprofen (active enantiomer).

values for PGE<sub>2</sub> and TXB<sub>2</sub> inhibition were respectively 2460 and 865 ng ml<sup>-1</sup> in rats and 10400 and 56700 ng ml<sup>-1</sup> in healthy subjects. IC<sub>80</sub> values for PGE<sub>2</sub> and TXB<sub>2</sub> inhibition were respectively 90949 and 3884 ng ml<sup>-1</sup> in rats and 89518 and >4.34\*10<sup>8</sup> ng ml<sup>-1</sup> in healthy subjects (table 6).

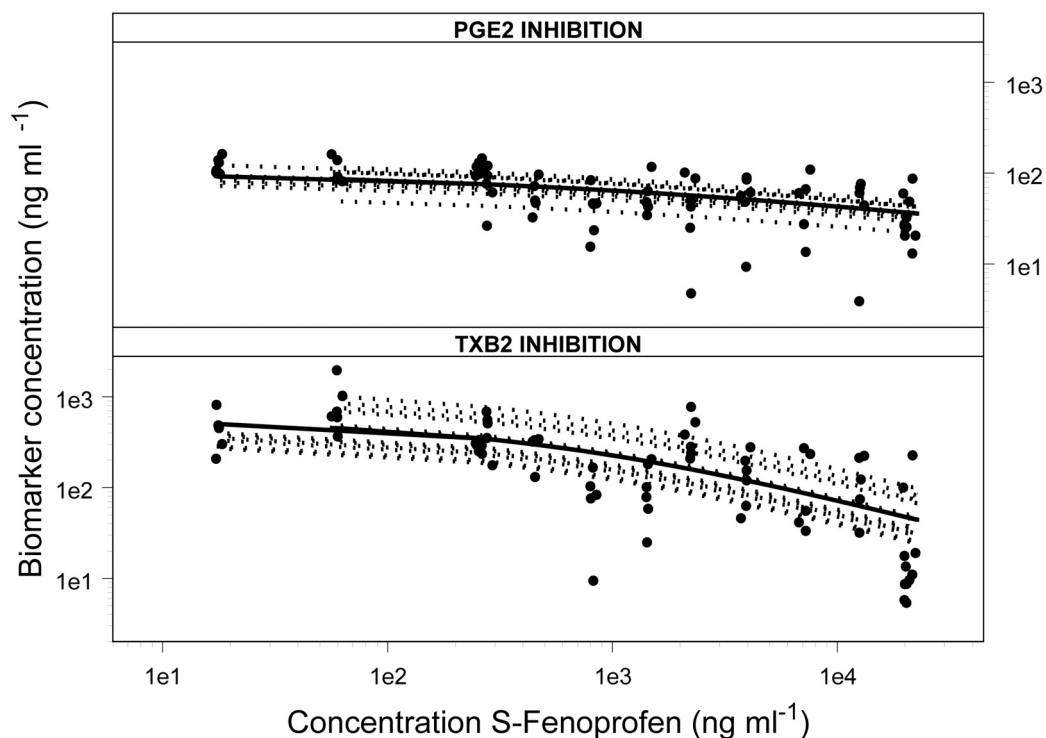

**Figure 5.** Pharmacodynamics of fenopfen *in vivo* in rats. Upper panel: fenopfen concentrations versus PGE<sub>2</sub> inhibition. Lower panel: fenopfen concentrations versus TXB<sub>2</sub> inhibition. Solid symbols represent individual data points. Solid black line indicates the population prediction, dashed lines indicate individual predictions.

Interestingly, the potency for TXB<sub>2</sub> inhibition was more than 2-fold increased for SLE patients, 20900 ng ml<sup>-1</sup>, compared to healthy subjects.

When *in vivo* data were compared to the *in vitro* results, it is noticeable that Hill coefficients for both biomarkers are lower *in vivo* than *in vitro*. Whilst IC<sub>80</sub> values for PGE<sub>2</sub> inhibition *in vitro* and *in vivo* are comparable between species, large differences were observed for the IC<sub>80</sub> values for TXB<sub>2</sub> inhibition. No covariates were identified which showed a significant effect on parameter estimates.

**Table 5.** Population pharmacodynamic estimates for the *in vivo* inhibitory effects of fenopfen on PGE<sub>2</sub> and TXB<sub>2</sub> production in rats, healthy subjects and SLE patients. Values in parentheses are relative standard errors (%) of the estimates.

Parameter	Parameter estimate	IIV*	Parameter estimate	IIV*
PGE <sub>2</sub> inhibition				
<i>Fixed effects</i>		Rats		Healthy subjects
I <sub>0</sub> (ng mL <sup>-1</sup> )	105 (8)		3.65 (21)	92 (37)
IC <sub>50</sub> (ng mL <sup>-1</sup> )	2460 (76)		10400 (13)	
Hill coefficient Healthy	0.384 (15)	27 (82)	0.644 (20)	
Hill coefficient SLE	-	-	1.25 (27)	75 (82)
I <sub>max</sub> (ng mL <sup>-1</sup> )	5.53 (-)		0.0095 (30)	
Proportional error (%)	43 (12)		50 (18)	
TXB <sub>2</sub> inhibition				
<i>Fixed effects</i>		Rats		Healthy subjects
I <sub>0</sub> (ng mL <sup>-1</sup> )	518 (11)	31 (56)	769 (7)	25 (35)
IC <sub>50</sub> (ng mL <sup>-1</sup> ) Healthy	865 (37)	114 (36)	56700 (19)	
IC <sub>50</sub> (ng mL <sup>-1</sup> ) SLE			20900 (24)	83 (81)
Hill coefficient	0.923 (12)		1.86 (22)	
I <sub>max</sub> (ng mL <sup>-1</sup> )	1 (-)		37.6 (13)	
Proportional error (%)	54 (12)		34 (29)	

Based on a scenario analysis and assuming that effective anti-inflammatory effect and analgesia

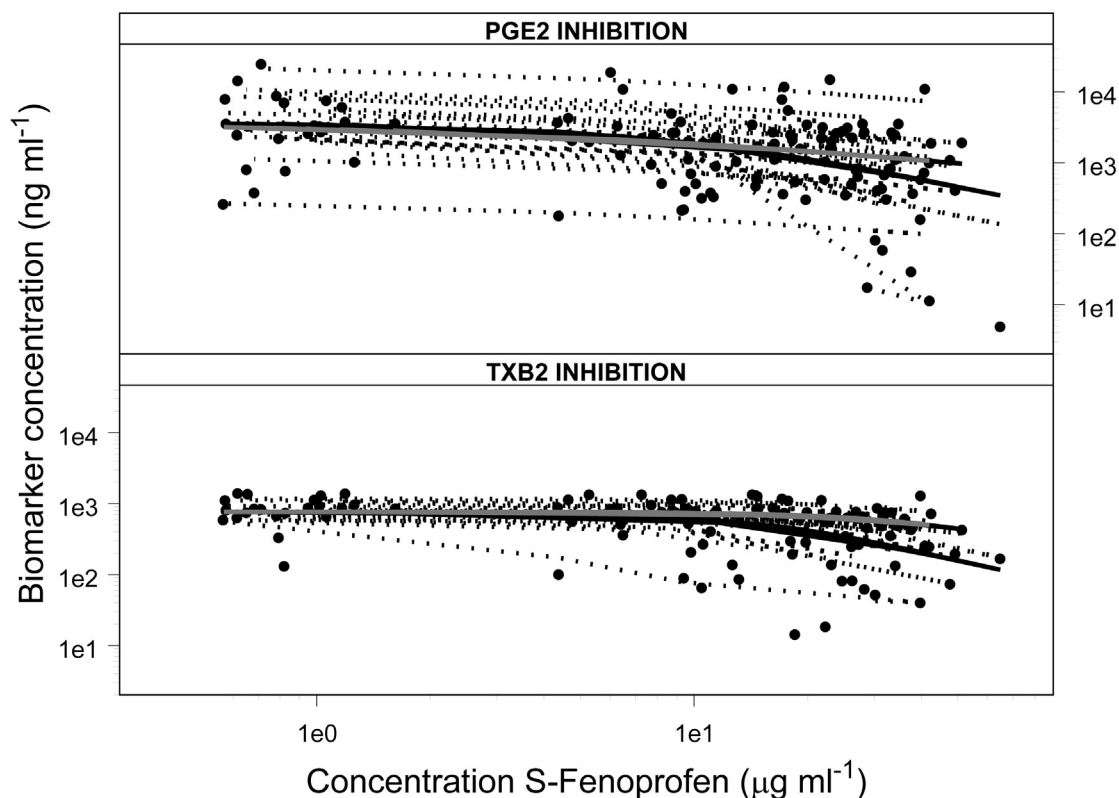

**Figure 6.** Pharmacodynamics of fenopfen *in vivo* in healthy subjects and SLE patients. Upper panel: fenopfen concentrations versus PGE<sub>2</sub> inhibition. Lower panel: fenopfen concentrations versus TXB<sub>2</sub> inhibition. Solid symbols represent individual data points. Solid black line indicates the population prediction in SLE patients, grey line indicates the population prediction in healthy subjects. Dashed lines indicate individual predictions.

requires minimum inhibition of PGE<sub>2</sub> > 80%, we have estimated the dosing requirement for this specific patient population, indicating the corresponding impact on coagulation induced by TXB<sub>2</sub> inhibition. The simulated pharmacokinetic and pharmacodynamic profiles (i.e., PGE<sub>2</sub> and TXB<sub>2</sub> inhibition) for a typical SLE patient are displayed in figure 7.

The results for the simulation based on the four different starting approaches are displayed in figure 8. In addition, a graphical representation of dose per intake versus the time above 80% inhibition

**Table 6.** *In vitro* and *in vivo* IC<sub>80</sub> estimates for fenopfen in rats, healthy subjects and SLE patients.

	IC <sub>80</sub> (ng ml <sup>-1</sup> ) PGE <sub>2</sub> inhibition	IC <sub>80</sub> (ng ml <sup>-1</sup> ) TXB <sub>2</sub> inhibition
Rat		
<i>In vitro</i> results	25983	33400
<i>In vivo</i> results	90949	3884
Humans		
<i>In vitro</i> results	21538	4778
<i>In vivo</i> results	89518	>4.34*10 <sup>8</sup>



showed that for PGE<sub>2</sub> inhibition, *in vitro* data using healthy subject or rat blood closely correlate with patient data *in vivo*. On the other hand, for TXB<sub>2</sub> inhibition, our results reveal that patient data cannot be easily extrapolated from *in vitro* data in either species. The plot also provides information about the dose required to ensure inhibition is maintained above 80% inhibition. For instance, a dose of 400 mg per intake corresponds to exposure levels above IC<sub>80</sub> over half of the dosing interval, whilst a dose of 800 mg per intake corresponds to exposure levels above that same threshold over 80% of the dosing interval.

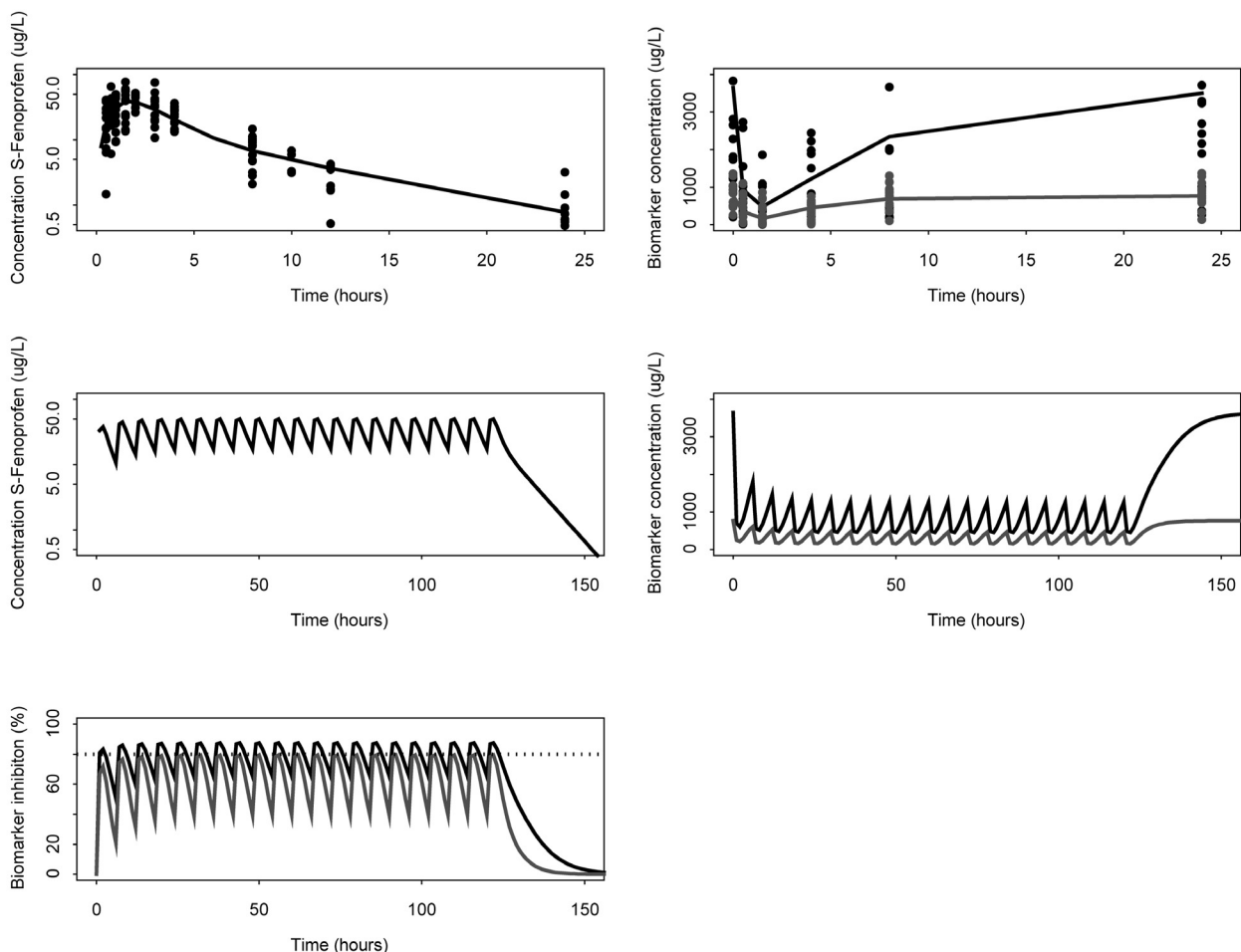

**Figure 7.** Simulation of fenopropfen 600 mg q4d. The exposure and biomarker profiles are simulated based on the *in vivo* pharmacokinetic and pharmacodynamic model in SLE patients.. Upper left plot shows the pharmacokinetic profile after single oral dose (600 mg). Black line represents the population prediction and dots are the observed data in SLE patients. Upper right plot shows the pharmacodynamic profile of the biomarker concentrations after single oral dose. Black line represents PGE<sub>2</sub> concentrations and grey lines represents TXB<sub>2</sub> concentrations. Left graph on second row represents pharmacokinetic profile after multiple dosing 600 mg q4d. Right graph on the second row represents biomarker concentration profile after multiple administration. Black line represents PGE<sub>2</sub> concentrations and grey lines represents TXB<sub>2</sub> concentrations. Left graph on third row represents biomarker inhibition profile after multiple administration. Black lines represent PGE<sub>2</sub> inhibition and grey lines represents TXB<sub>2</sub> inhibition. Dashed line represents the 80% inhibition level.

## DISCUSSION AND CONCLUSION

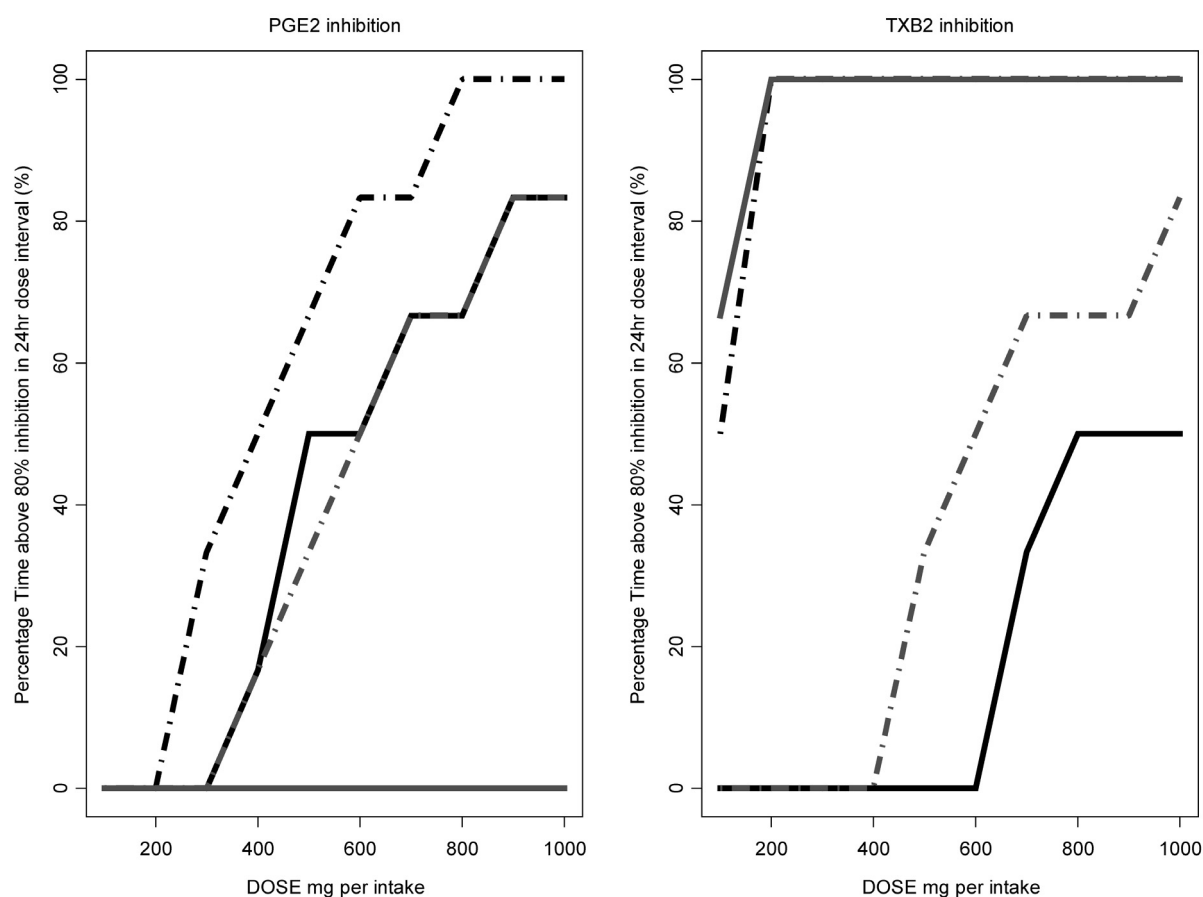

**Figure 8.** Dose of fenoprofen versus the percentage of the time above  $IC_{80}$  during a 24 hour dosing interval and steady-state conditions. The doses indicated on the x-axis are dose per intake. Black solid and dashed lines represent, respectively, the results based on *in vivo* and *in vitro* parameters in healthy subjects, the grey solid and dashed lines represent, respectively, the results based on *in vivo* and *in vitro* parameters in rats.

In the current investigation we show how a model-based approach can be used in early drug development to guide dose selection of COX inhibitors in chronic disease conditions, as in the case of SLE. We illustrate the importance of biomarkers in the assessment of the anti-inflammatory effect and highlight the value and limitations of *in vitro* human data to predict the effective dosing regimen in patients. Moreover, this manuscript highlights how simulations can be used to translate pharmacokinetic-pharmacodynamic relationships into appropriate dose recommendations.

*Baseline biomarkers.* An important assumption underlying our investigation is the evidence for a threshold or minimum level of COX-inhibition to ensure clinical response. In this regard, consideration must be given to the inflammatory activity of endogenous mediators associated with cyclo-oxygenase and to other regulatory mechanisms triggered by inflammatory stimuli (21;22). Of particular interest are the turnover rate and baseline levels of prostacyclins. From a pharmacological perspective, it is not the suppression of cyclo-oxygenase itself which warrants anti-inflammatory and analgesic effects, but rather the suppression of inflammatory mediators, i.e., the products of COX-activity. On the other hand, differences in drug selectivity for COX-1 and COX-2 will cause variable inhibition of prostglandins and thromboxanes *in vivo*, yielding a distinctive safety profile. Hence, predictions of treatment effect in the target patient population from data in healthy subjects, from

pre-clinical models or *in vitro* experiments require a great degree of understanding of the downstream cascade of inflammation, as well as of the differences between species under healthy and disease conditions.

Interestingly, our results showed that LPS-induced PGE<sub>2</sub> baseline levels *in vivo* were significantly different from *in vitro* data in humans and in rats. *In vitro* values were 10 fold higher than *in vivo*, with even larger differences between human and rat data. Unfortunately, there are no previous publications in which such a comprehensive evaluation has been performed to explain the discrepancy observed between experimental settings. Given this is a validated analytical method we deem it very unlikely that experimental procedures in the immunoassay in the two laboratories might be the reason for the observed results. Except for the possibility of PGE<sub>2</sub> degradation during storage (23), such differences in patients may reflect a time-dependent suppression of COX from lymphocytes *in vivo*. This might occur despite the wash-out period for pharmacokinetics in plasma if COX-2 turnover is longer than the pharmacokinetic half-life of drugs administered prior to enrolment.

In contrast, baseline values for TXB<sub>2</sub> *in vivo* were significantly higher than *in vitro*. These findings are in agreement with published results (24;25).

*Biomarker modelling in vitro.* The use of *in vitro* biomarkers as predictors of drug effect *in vivo* relies on the assumption that LPS-induced PGE<sub>2</sub> production from lymphocytes mimics prostacyclin dynamics during inflammatory conditions. Correct interpretation of the results will also depend on the concordance with COX-2 activity and turnover *in vivo*. Recently, the turnover of COX-2 was determined at ~5 hrs (26), indicating that an incubation period of 24 hours can introduce variability in response.

Similarly, safety pharmacology can be evaluated in a quantitative manner by characterising COX-1 inhibition and its impact on TXB<sub>2</sub> production. On the other hand, our intent to correlate animal and human data *in vitro* was aimed at exploring whether differences in pharmacology exist that would explain discrepancies in efficacy in animal models of pain, as compared to drug response in patients. In fact, we challenge the need for pain models in the development of COX inhibitors and anticipate the possibility to predict the effective anti-inflammatory dose based primarily on drug effect on biomarkers. Our investigation also attempts to establish whether the *in vitro* parameter estimates in humans correlate better with treatment effect than by scaling *in vivo* data across species.

In line with our findings for other selective and non-selective COX inhibitors (27), IC<sub>50</sub> values were comparable between rats and humans for PGE<sub>2</sub> inhibition (10500 ng ml<sup>-1</sup> versus 11200 ng ml<sup>-1</sup> for rats and humans, respectively), but significantly different for TXB<sub>2</sub> inhibition (8350 ng ml<sup>-1</sup> versus 1590 ng ml<sup>-1</sup> for rats and humans, respectively). Maximum inhibitory levels were higher than 93.8% for PGE<sub>2</sub> in rats and more than 99% for the PGE<sub>2</sub> levels in humans and TXB<sub>2</sub> levels in rats and humans. Log (COX-2/COX-1) ratio is 0.10 in rats and 0.84 in humans and indicates that fenoprofen can be considered a non-selective COX inhibitor. These results are comparable to results published by Warner *et al.* (IC<sub>50</sub>, 21427 and 1776 ng ml<sup>-1</sup> for PGE<sub>2</sub> and TXB<sub>2</sub> inhibition in

humans, respectively) (28).

*Pharmacokinetic modelling of fenoprofen in rats.* The chiral properties of fenoprofen make it also an interesting case to demonstrate the relevance of pharmacokinetic factors when scaling *in vivo* data from animals to humans. In this specific case, it is not only pharmacodynamics which may account for discrepancies in the effective dose between animal models and patients, but also the differences in exposure to the active enantiomer, which may vary considerably across species.

In contrast to humans, only S-fenoprofen was detectable in plasma after i.p. administration of fenoprofen to rats, which indicates a high metabolic clearance for R-fenoprofen. In rats, the major metabolic routes for fenoprofen include chiral inversion in the liver and intestines, as well as oxidation and glucuronidation in the liver (18). Given that some of individual curves of S-fenoprofen showed a secondary peak in the plasma profile, approximately 20-120 min after dosing, we have assumed these peaks to be the result of systemic conversion of R-fenoprofen,

*Pharmacokinetic modelling of fenoprofen in healthy subjects and SLE patients.* In the study in SLE patients and healthy subjects, both enantiomers were detectable, which allowed investigation of a pharmacokinetic model for both enantiomers. Interestingly, SLE patients showed approximately a 50% decrease in the volume of distribution of R-fenoprofen. The impact of this decrease in volume of distribution of this rather limited as can be seen in figure 5. In contrast, no differences between patients and healthy subjects were observed for the active enantiomer, S-fenoprofen. The reported oral clearance and volume of distribution of S-fenoprofen was found to be higher than the values reported by Poggi *et al.* and Barissa *et al.* (16;29). We believe that previous estimates are biased by the use of a standard non-compartmental analysis of pharmacokinetic data without taking into account the influence of chiral inversion *in vivo*.

*Biomarker modelling in vivo.* The assessment of biomarkers as predictors of drug effect *in vivo* relies on the assumption that such a biomarker is on the pathway between pharmacological effect and clinical response (30). Prostacyclins are known to play an important role in acute inflammation, but multiple factors concur under chronic conditions which can modulate the overall inflammatory response, such as TNF- $\alpha$  and interleukins (21;22). In addition, a reliable correlation must exist between disease and the experimental conditions in which biomarkers are quantified. In our investigation, direct anti-inflammatory activity is expected upon administration of fenoprofen *in vivo*, which means a concentration-dependent inhibition of COX in blood cells. Upon experimental conditions, LPS-induced PGE<sub>2</sub> production will depend on drug levels and on the remaining fraction of unbound COX-2 at each sampling time, on the rate of induction and reversibility of the binding of the drug-enzyme complex. Given the standardisation procedures of the method and rapid disappearance of PGE<sub>2</sub> from plasma, one would expect drug levels (*i.e.*, clearance) and amount of unbound COX-2 to explain potential differences in the suppression of the biomarker over time in patients and under experimental conditions *in vivo*. Since incubation procedures prevent drug clearance, it is conceivable that differences will exist between biomarker and anti-inflammatory response for drugs with high clearance and reversible binding versus those with irreversible binding

or slow-dissociation kinetics, which is not the case for fenoprofen. The same considerations apply to the assessment of drug effect on COX-1, when quantifying the inhibition of TXB<sub>2</sub>.

In contrast, we have shown that discrepancies exist between animal and human data *in vivo*. The lack of such a strict correlation for behavioural measures of analgesia and anti-inflammatory activity has been the subject of a continuous debate in the scientific community. These differences raise the question whether scaling of animal data is required in early drug development or whether *in vitro* data (i.e., human blood) can provide more accurate estimates of drug effect in the target patient population.

From a modelling perspective, it is noteworthy to highlight that Hill coefficients *in vivo* were shallower than estimates *in vitro*. This difference suggests a different regulatory mechanism in the transduction pathway *in vivo*. Moreover, drug response does not seem to be altered by disease, as indicated by I<sub>max</sub> values in healthy subjects and SLE patients. Only potency estimates for TXB<sub>2</sub> inhibition differed between SLE patients and healthy subjects. IC<sub>50</sub> values in SLE patients were significantly lower than in healthy subjects (IC<sub>50</sub>, 20900 vs 56700 ng ml<sup>-1</sup>, p<0.01). Despite controlled experimental conditions, large variation was observed in parameter estimates in SLE patients. These findings are in agreement with Patrignani *et al.*, who have shown that the inhibition of PGE<sub>2</sub> and TXB<sub>2</sub> by COX inhibitors display rather large inter-individual variability (31).

*In vitro-in vivo correlation.* The aim in drug development is to predict the analgesic dose in patients as early in the developmental process as possible. Therefore, results in animals which could be scaled to clinical results facilitate the drug development. A biomarker such as PGE<sub>2</sub> and TXB<sub>2</sub> inhibition can be measured *in vitro* and *in vivo* in animals, healthy volunteers and patients and knowledge on the inter-relationship between *in vivo*, *in vitro*, animal and patient would provide a scientific basis for dose selection. It has been reported that IC<sub>80</sub> values evaluated *in vitro* for PGE<sub>2</sub> inhibition correlate directly with analgesic plasma concentrations of different COX inhibitors (13). In table 6, we have calculated the IC<sub>80</sub> values for the different assays for fenoprofen. The *in vitro-in vivo* correlation in rats (IC<sub>80</sub>, 25983 vs 90949 ng ml<sup>-1</sup> *in vitro* and *in vivo* in rats, respectively) and in humans (IC<sub>80</sub>, 21538 vs 89518 ng ml<sup>-1</sup> *in vitro* and *in vivo* in humans, respectively) is in the same magnitude of order, although not statistically significant. Fenoprofen is approximately four times more potent *in vitro*. Similar findings have been observed by Panara *et al.* in a first attempt to compare *in vitro* and *in vivo* PGE<sub>2</sub> and TXB<sub>2</sub> inhibition following administration of meloxicam to healthy subjects. The authors estimated IC<sub>50</sub> values for PGE<sub>2</sub> and TXB<sub>2</sub> inhibition *in vitro* and graphically presented *in vivo* data in conjunction with the *in vitro* predictions. The concentration response curve for inhibition of PGE<sub>2</sub> appeared to be similar *in vitro* and *in vivo*, whereas inhibition of TXB<sub>2</sub> *in vivo* was a 10-fold less potent than *in vitro*. Hill coefficients varied between 1-2.12 for the *in vitro* data and were much steeper than the results *in vivo* (0.384-1.86). The *in vitro* Hill coefficients are less influenced by the variability observed in the *in vivo* data.

The observed differences seemed to have little clinical significance (25). The inter-species relationship is almost one to one for *in vitro* (IC<sub>80</sub>, 25983 vs. 21538 ng ml<sup>-1</sup> in rats and in humans,

respectively) and *in vivo* data (IC<sub>80</sub>, 90949 vs. 89518 ng ml<sup>-1</sup> in rats and in humans, respectively). However, for TXB<sub>2</sub> inhibition, we could not observe such a correlation. Such a discrepancy has been shown recently in a comparative analysis of PGE<sub>2</sub> and TXB<sub>2</sub> inhibition in horse, sheep, calf, goat and cat (32). In this publication potency estimates did not scale allometrically across species.

*Conclusion.* The relationship between fenoprofen concentrations and the inhibitory effect on PGE<sub>2</sub> and TXB<sub>2</sub> has been characterised *in vitro* and *in vivo* in rats and healthy subjects and SLE patients. Parameterisation of the concentration-response curve provided evidence that differences exist between species and that *in vitro-in vivo* correlations should be used to predict drug properties in the target population. Differences between species could eventually be overcome by appropriate scaling factors, but this should be carefully considered, given the dissimilarities in the physiology of pain and coagulation across species. The use of human biomarkers *in vitro* is therefore recommended as basis for the selection of the clinical dose range.

Whilst focus is given to efficacy when defining an effective dose range, we have also shown that the use of simulation scenarios enables an integrated evaluation of multiple endpoints, providing a stronger rationale for dose selection and better estimation of the risk:benefit ratio.

*Acknowledgements.* We gratefully acknowledge the technical assistance of Margret Blom-Roosemalen. The work presented in this paper was supported by a fellowship from GlaxoSmithKline, Harlow, United Kingdom.

## REFERENCES

- (1) Okie S. Raising the safety bar--the FDA's coxib meeting. *N Engl J Med* 2005; 352(13):1283-1285.
- (2) Bolten WW, Reiter S. [Cardiovascular risks of Cox-2-antagonists. Opinion on the marketed name rofecoxib, and its market-withdrawn valdecoxib and the actual therapeutic restrictions]. *Z Rheumatol* 2005; 64(4):286-289.
- (3) Salinas G, Rangasetty UC, Uretsky BF, Birnbaum Y. The cyclooxygenase 2 (COX-2) story: it's time to explain, not inflame. *J Cardiovasc Pharmacol Ther* 2007; 12(2):98-111.
- (4) Motsko SP, Rascati KL, Busti AJ, Wilson JP, Barner JC, Lawson KA et al. Temporal relationship between use of NSAIDs, including selective COX-2 inhibitors, and cardiovascular risk. *Drug Saf* 2006; 29(7):621-632.
- (5) Laible B. COX-2 inhibitors and cardiovascular toxicity: a class effect? *S D J Med* 2005; 58(3):93-94.
- (6) Jones TC. Call for a new approach to the process of clinical trials and drug registration. *BMJ* 2001; 322(7291):920-923.
- (7) Jones TC. A call to restructure the drug development process: government over-regulation and non-innovative late stage (Phase III) clinical trials are major obstacles to advances in health care. *Sci Eng Ethics* 2005; 11(4):575-587.
- (8) Venitz J. Using exposure-response and biomarkers to streamline early drug development. *Ernst Schering Res Found Workshop* 2007;(59):47-63.
- (9) Derendorf H, Lesko LJ, Chaikin P, Colburn WA, Lee P, Miller R et al. Pharmacokinetic/pharmacodynamic modeling in drug research and development. *J Clin Pharmacol* 2000; 40(12 Pt 2):1399-1418.
- (10) Schmassmann A, Zoidl G, Peskar BM, Waser B, Schmassmann-Suhijar D, Gebbers JO et al. Role of the different isoforms of cyclooxygenase and nitric oxide synthase during gastric ulcer healing in cyclooxygenase-1 and -2 knockout mice. *Am J Physiol Gastrointest Liver Physiol* 2006; 290(4):G747-G756.
- (11) Radi ZA, Khan NK. Effects of cyclooxygenase inhibition on bone, tendon, and ligament healing. *Inflamm Res* 2005; 54(9):358-366.
- (12) Wilgus TA, Bergdall VK, Tober KL, Hill KJ, Mitra S, Flavahan NA et al. The impact of cyclooxygenase-2 mediated inflammation on scarless fetal wound healing. *Am J Pathol* 2004; 165(3):753-761.
- (13) Huntjens DR, Danhof M, Della Pasqua OE. Pharmacokinetic-pharmacodynamic correlations and biomarkers in the development of COX-2 inhibitors. *Rheumatology (Oxford)* 2005; 44(7):846-859.
- (14) Huntjens DR, Spalding DJ, Danhof M, Della Pasqua OE. Correlation between in vitro and in vivo concentration-effect relationships of naproxen in rats and healthy volunteers. *Br J Pharmacol* 2006; 148(4):396-404.
- (15) Horizon AA, Wallace DJ. Risk:benefit ratio of nonsteroidal anti-inflammatory drugs in systemic lupus erythematosus. *Expert Opin Drug Saf* 2004; 3(4):273-278.
- (16) Barissa GR, Poggi JC, Donadi EA, dos Reis ML, Lanchote VL. Influence of rheumatoid arthritis in the enantioselective disposition of fenoprofen. *Chirality* 2004; 16(9):602-608.
- (17) Castro E, Soraci A, Fogel F, Tapia O. Chiral inversion of R(-) fenoprofen and ketoprofen enantiomers in cats. *J Vet Pharmacol Ther* 2000; 23(5):265-271.
- (18) Berry BW, Jamali F. Presystemic and systemic chiral inversion of R(-)-fenoprofen in the rat. *MJ Pharmacol Exp Ther* 1991; 258(2):695-701.
- (19) Mehvar R, Jamali F. Pharmacokinetic analysis of the enantiomeric inversion of chiral nonsteroidal antiinflammatory drugs. *Pharm Res* 1988; 5(2):76-79.
- (20) Cristofani PJ, Barissa GR, Donadi EA, Lanchote VL, Lemos dos RM. Enantioselective kinetic disposition of fenoprofen in rats with experimental diabetes or adjuvant-induced arthritis. *Pharmacology* 2004; 72(2):85-91.
- (21) Omoigui S. The biochemical origin of pain: the origin of all pain is inflammation and the inflammatory response. Part 2 of 3 - inflammatory profile of pain syndromes. *Med Hypotheses* 2007; 69(6):1169-1178.
- (22) Omoigui S. The biochemical origin of pain--proposing a new law of pain: the origin of all pain is inflammation and the inflammatory response. Part 1 of 3--a unifying law of pain. *Med Hypotheses* 2007; 69(1):70-82.
- (23) Jacobi KE, Wanke C, Jacobi A, Weisbach V, Hemmerling TM. Determination of eicosanoid and cytokine production in salvaged blood, stored red blood cell concentrates, and whole blood. *J Clin Anesth* 2000; 12(2):94-99.
- (24) Panara MR, Padovano R, Sciulli MG, Santini G, Renda G, Rotondo MT et al. Effects of nimesulide on constitutive and inducible prostanoid biosynthesis in human beings. *Clin Pharmacol Ther* 1998; 63(6):672-681.
- (25) Panara MR, Renda G, Sciulli MG, Santini G, Di Giamberardino M, Rotondo MT et al. Dose-dependent inhibition of platelet cyclooxygenase-1 and monocyte cyclooxygenase-2 by meloxicam in healthy subjects. *J Pharmacol Exp Ther* 1999; 290(1):276-280.
- (26) Mbonye UR, Yuan C, Harris CE, Sidhu RS, Song I, Arakawa T et al. Two distinct pathways for cyclooxygenase-2 protein degradation. *J Biol Chem* 2008; 283(13):8611-8623.
- (27) Huntjens DR, Spalding DJ, Danhof M, Della Pasqua OE. Differences in the in vitro and in vivo concentration-effect relationship of selective and non-selective COX inhibitors: role of translational pharmacology in pain research. 2008.
- (28) Warner TD, Giuliano F, Vojnovic I, Bukasa A, Mitchell JA, Vane JR. Nonsteroid drug selectivities for cyclooxygenase-1 rather than cyclo-oxygenase-2 are associated with human gastrointestinal toxicity: a full in vitro analysis. *Proc Natl Acad Sci U S A* 1999; 96(13):7563-7568.
- (29) Poggi JC, Barissa GR, Donadi EA, Foss MC, de Queiroz CF, Lanchote VL et al. Pharmacodynamics, chiral pharmacokinetics, and pharmacokinetic-pharmacodynamic modeling of fenoprofen in patients with diabetes mellitus. *J Clin Pharmacol* 2006; 46(11):1328-1336.
- (30) Danhof M, Alvan G, Dahl SG, Kuhlmann J, Paintaud G. Mechanism-based pharmacokinetic-pharmacodynamic modeling-a new classification of biomarkers. *Pharm Res* 2005; 22(9):1432-1437.
- (31) Patrignani P, Panara MR, Sciulli MG, Santini G, Renda G, Patrono C. Differential inhibition of human prostaglandin endoperoxide synthase-1 and -2 by nonsteroidal anti-inflammatory drugs. *J Physiol Pharmacol* 1997; 48(4):623-631.
- (32) Lees P, Giraudel J, Landoni MF, Toutain PL. PK-PD integration and PK-PD modelling of nonsteroidal anti-inflammatory drugs: principles and applications in veterinary pharmacology. *J Vet Pharmacol Ther* 2004; 27(6):491-502.





