



Universiteit
Leiden
The Netherlands

Endocrine and metabolic features of familial longevity : the Leiden Longevity Study

Rozing, M.P.

Citation

Rozing, M. P. (2011, September 21). *Endocrine and metabolic features of familial longevity : the Leiden Longevity Study*. Retrieved from <https://hdl.handle.net/1887/17849>

Version: Corrected Publisher's Version

License: [Licence agreement concerning inclusion of doctoral thesis in the Institutional Repository of the University of Leiden](#)

Downloaded from: <https://hdl.handle.net/1887/17849>

Note: To cite this publication please use the final published version (if applicable).

**ENDOCRINE AND METABOLIC FEATURES OF FAMILIAL LONGEVITY:
THE LEIDEN LONGEVITY STUDY**

MAARTEN P. ROZING

ISBN 978-94-6108-211-4

© 2011 M.P. Rozing

Copyright of each chapter is with the publisher of the journal in which the work has appeared. No part of this thesis may be reproduced, stored in a retrieval system or transmitted in any form or by any means, without permission of the author or, when appropriate, of the publisher of publications.

Design & Layout A.M. Christiaanse and M.P. Rozing
Cover illustration Jan Lievens, *Vanitas stilleven ca. 1627*
Printed by GildePrint, Enschede

This research was performed within the framework of the Netherlands Consortium for Healthy Ageing, which is financially supported by the Netherlands Genomics Initiative (project number 050-060-810).

Financial support by the Netherlands Consortium for Healthy Ageing for the publication of this thesis is gratefully acknowledged.

**ENDOCRINE AND METABOLIC FEATURES OF FAMILIAL LONGEVITY:
THE LEIDEN LONGEVITY STUDY**

Proefschrift

ter verkrijging van

de graad van Doctor aan de Universiteit Leiden

op gezag van de Rector Magnificus prof. Mr. P.F. van der Heijden

volgens het besluit van het College der Promoties

te verdedigen op woensdag 21 september 2011

klokke 16:15

door

Maarten Pieter Rozing

geboren te Leiderdorp

in 1979

Promotiecommissie

Promotores:

Prof. dr. R.G.J. Westendorp

Prof. dr. P.E. Slagboom

Co-promotor:

Dr. ir. D. van Heemst

Overige leden:

Prof. dr. B. Demeneix (Centre National de la Recherche Scientifique, Museum National d'Histoire Naturelle, Parijs, Frankrijk)

Prof. dr. J.H.J. Hoeijmakers (Erasmus Universiteit Rotterdam)

Prof. dr. H. Pijl

Contents

Chapter 1: General introduction	7	
PART A: ON THE ENDOCRINE AND METABOLIC FEATURES OF FAMILIAL		
LONGEVITY: THE LEIDEN LONGEVITY STUDY		13
Chapter 2: Nonagenarian siblings and their offspring display lower risk of mortality and morbidity than sporadic nonagenarians: The Leiden Longevity Study	15	
Chapter 3: Favorable glucose tolerance and lower prevalence of metabolic syndrome in non-diabetic offspring of nonagenarian siblings: the Leiden Longevity Study.	27	
Chapter 4: Familial longevity is marked by enhanced insulin sensitivity	43	
Chapter 5: C-reactive protein and glucose regulation in familial longevity	63	
Chapter 6: Human insulin/IGF-1 and familial longevity at middle age.....	79	
Chapter 7: Reduced serum IGF-1 and familial longevity	95	
Chapter 8: Low serum free triiodothyronine levels mark familial longevity: the Leiden Longevity Study	105	
Chapter 9: Familial longevity is associated with decreased thyroid function.....	115	
Chapter 10: Serum triiodothyronine levels and inflammatory cytokine production capacity	127	
Chapter 11: General discussion and synopsis of part A.....	141	
PART B: ON DETERMINING THE RATE OF SENESCENCE.....		153
Introduction to part B.....	155	
Chapter 12: Parallel lines: nothing has changed?.....	157	
Chapter 13: Senescence rates in patients with end-stage renal disease: a critical appraisal of the Gompertz model	169	
General discussion and synopsis part B	183	
PART C: APPENDICES		185

Appendix A: General discussion and synopsis in Dutch Part A.....	187
Appendix B: General discussion and synopsis in Dutch Part B.	199
Appendix C: Acknowledgements.....	201
Appendix D: Curriculum vitae	203
Appendix E: List of publications.....	205

Chapter 1: General introduction to endocrine and metabolic features of familial longevity: the Leiden Longevity Study

Maarten P. Rozing^{1,3}, P. Eline Slagboom^{2,3}, Rudi G.J. Westendorp^{1,3}, Diana van Heemst^{1,3}, on behalf of the Leiden Longevity Study (LLS) Group

From the ¹Department of Gerontology and Geriatrics, ²Department of Medical Statistics, section Molecular Epidemiology, Department of Medical Statistics, Leiden University Medical Center, PO Box 9600, 2300 RC Leiden, The Netherlands, ³Netherlands Consortium of Healthy Aging (NCHA).



Chapter 1

World life expectancy has rapidly increased over the last two centuries, from roughly 25 years to about 65 years for males and 70 years for females ¹. Before 1950, the improvement in life expectancy was achieved through reductions in mortality at younger ages ². However, in the second half of the 20th century this improvement was mainly due to a gain in life-expectancy at older ages ³. Unfortunately, not all of the gained years of life are spent in good health. Currently extensive research in both model organisms and humans focuses at identifying the genetically determined pathways and mechanisms of healthy longevity. Understanding the role of these pathways and mechanisms in longevity might eventually reveal targets for interventions to prevent aging-related loss of function and disease⁴.

Various attempts have been made to identify genetic markers of the regulatory pathways that underlie human longevity. As yet, the results of these studies are hindered by an increase of genome diversity when extrapolating results from experimental models to men, hampered by the critical dependency on the environmental conditions in which the genes are expressed, and biased by the absence of a valid control group when studying exceptionally long-lived individuals. In search for the biology of healthy longevity, and to circumvent the methodological problems mentioned above, we set off to study the phenotypes of exceptionally long-lived families in the Leiden Longevity Study. Substantial evidence supports the familial clustering of exceptional longevity. The existence of families showing aggregation of this long-lived phenotype implies a genetic basis ⁵⁻⁷. In this overview, we report on the endocrine and metabolic characteristics that appear to be pertinent for familial healthy longevity.

Leiden Longevity Study

Studies into determinants of human longevity commonly compare age groups of unrelated individuals. These so-called cross-sectional designs are particularly prone to confounding as cases and controls originate from different birth cohorts. An alternative design is to study multiple generations from long-lived families. This study design has been applied to both centenarians or nonagenarians and their middle aged offspring, i.e. the New England Centenarian Study⁸ and the Ashkenazi Jewish Centenarian Study⁹, and more recently to nonagenarian sibling pairs and their middle aged offspring, Leiden Longevity Study¹⁰.

The study design of the Leiden Longevity Study is depicted in **figure 1**. Families were eligible for participation if two or more long-lived siblings were alive who met the age criteria of 89 years or over for males and 91 years or over for females. Along with the long-lived siblings, their offspring and partners thereof were enrolled. In total 944 long-lived siblings participated with a mean age of 93 years (ranging from 89 to 103 years), 1671 offspring (mean age of 59 years, range: 34-80 years) and 744 partners (mean age 59 years, range: 30-79 years).

Figure 1. Study design of the Leiden Longevity Study. Black symbols denote siblings eligible for inclusion based on achieved age. Arrows indicate proband siblings.

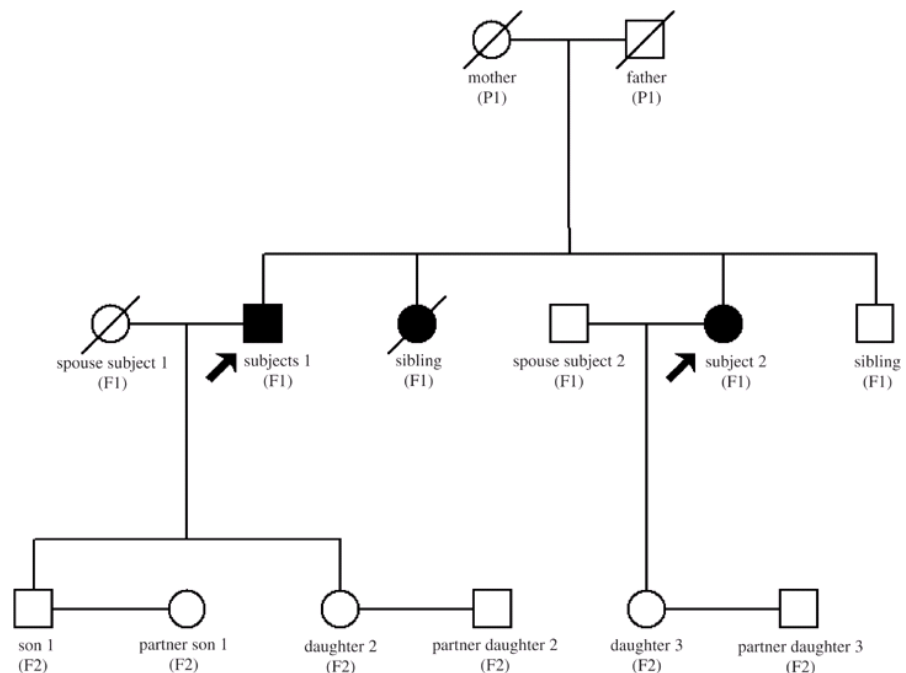

Our study design allowed for three approaches to identify longevity-associated phenotypes and underlying genotypes. First, we compared the group of familial nonagenarians with a group of sporadic nonagenarians (not selected on having nonagenarian siblings) from the Leiden 85-plus Study to distinguish between markers for familial longevity and markers for sporadic longevity.

Secondly, the offspring from long-lived individuals were compared to their middle aged partners as controls from the general population. Postulating that longevity-enabling genes are transmitted across generations, the offspring of long-lived nonagenarians represent cases predisposed for longevity, while their partners provided an appropriate control group. Finally, we calculated a family mortality history score which describes the mortality of the parents of the nonagenarian siblings compared to their birth cohort ¹¹. We thereby reasoned that in nonagenarian siblings from parents with a lower family mortality history score, indicating a lower than average mortality, traits related to longevity would be more pronounced than in nonagenarian siblings from parents with a higher family mortality history score.

The Leiden 85 Plus Study

In the Leiden 85-plus Study, a prospective, population-based study of all individuals 85 years old (birth cohort 1912–1914) living in Leiden, the Netherlands, 599 subjects were enrolled between September 1997 and September 1999. Of the Leiden 85-plus cohort, 275 subjects survived to the age of 90 years.

Outline of this thesis

The first part of this thesis, part A, discusses the endocrine and metabolic characteristics of long-lived families as observed in the Longevity Study. In **chapter two** we investigate two critical indicators of aging retardation. We compare the (late life) risk of mortality of nonagenarian siblings with that of sporadic nonagenarians as population based controls. Further, we determine the prevalence of morbidity in their offspring as compared to their partners. The following three chapters address the role of insulin sensitivity and glucose regulation in familial longevity. In **chapter three** we firstly compare the prevalence of metabolic syndrome and its individual risk components between offspring of nonagenarian siblings and their partners. Secondly, we explore differences in glucose metabolism between offspring and partners by performing an oral glucose tolerance test. To compare tissue specific insulin action between offspring of long-lived siblings and controls, a double tracer, 2-step hyperinsulinaemic euglycaemic clamp was performed. Results of this experiment are given in **chapter four**. In **chapter five** we investigate the relation between low grade inflammation and glucose regulation in the two groups. Closely related to insulin sensitivity, is the IGF-1 signaling pathway. In **chapter six** and **seven** hallmark phenotypes of the IGF-1 signaling pathway (height and serum IGF-1 axis parameters) are presented for middle aged offspring and the nonagenarian siblings respectively. Another endocrine system implicated in modulating the aging process is the hypothalamo–pituitary–thyroid axis. This topic is treated in chapter eight to ten. **Chapter eight** and **nine** include the study of serum thyroid

hormone parameters in middle-aged offspring and nonagenarian siblings. **Chapter ten** explores a mutual relation between peripheral thyroid hormones and immune function in the Leiden 85-plus Study. **Chapter eleven** gives an overview of the main findings presented in this thesis and discusses their relation to the current state of the field of longevity research.

The second part of this thesis, part B, includes a critical appraisal of the definition of the rate of senescence. Classic inference from the Gompertz law of aging has led to the conclusion that the rate of senescence is unaffected by environmental conditions. In **chapter twelve** we propose an alternative method for assessment of the rate of senescence. In **chapter thirteen** we will empirically test this novel approach in a population of renal patients, a population known to experience accelerated aging.

Reference List

- (1) Riley J. *Rising Life Expectancy: A Global History*. Cambridge: Cambridge Univ. Press, 2001.
- (2) Wilmoth JR, Deegan LJ, Lundstrom H, Horiuchi S. Increase of maximum life-span in Sweden, 1861-1999. *Science* 2000;289:2366-2368.
- (3) Oeppen J, Vaupel JW. Demography. Broken limits to life expectancy. *Science* 2002;296:1029-1031.
- (4) Fontana L, Partridge L, Longo VD. Extending healthy life span--from yeast to humans. *Science* 2010;328:321-326.
- (5) Gudmundsson H, Gudbjartsson DF, Frigge M, Gulcher JR, Stefansson K. Inheritance of human longevity in Iceland. *Eur J Hum Genet* 2000;8:743-749.
- (6) Skytthe A, Pedersen NL, Kaprio J et al. Longevity studies in GenomEUtwin. *Twin Res* 2003;6:448-454.
- (7) Hjelmborg J, Iachine I, Skytthe A et al. Genetic influence on human lifespan and longevity. *Hum Genet* 2006;119:312-321.
- (8) Perls TT, Wilmoth J, Levenson R et al. Life-long sustained mortality advantage of siblings of centenarians. *Proc Natl Acad Sci U S A* 2002;99:8442-8447.
- (9) Atzmon G, Schechter C, Greiner W, Davidson D, Rennert G, Barzilai N. Clinical phenotype of families with longevity. *J Am Geriatr Soc* 2004;52:274-277.
- (10) Schoenmaker M, de Craen AJ, de Meijer PH et al. Evidence of genetic enrichment for exceptional survival using a family approach: the Leiden Longevity Study. *Eur J Hum Genet* 2006;14:79-84.
- (11) Houwing-Duistermaat JJ, Callegaro A, Beekman M, Westendorp RG, Slagboom PE, van Houwelingen JC. Weighted statistics for aggregation and linkage analysis of human longevity in selected families: the Leiden Longevity Study. *Stat Med* 2009;28:140-151.

Part A

ON THE ENDOCRINE AND METABOLIC FEATURES OF
FAMILIAL LONGEVITY: THE LEIDEN LONGEVITY STUDY



Chapter 2: Nonagenarian siblings and their offspring display lower risk of mortality and morbidity than sporadic nonagenarians: The Leiden Longevity Study

Rudi G.J. Westendorp^{1,4}, Diana van Heemst^{1,4}, Maarten P. Rozing^{1,4}, Marijke Frölich², Simon P. Mooijaart^{1,4}, Gerard-Jan Blauw¹, Marian Beekman^{3,4}, Bastiaan T. Heijmans^{3,4}, Anton J.M. de Craen^{1,4}, and P. Eline Slagboom^{3,4}, on behalf of the Leiden Longevity Study (LLS) Group

From the ¹Department of Gerontology and Geriatrics, ²Department of Clinical Chemistry, ³Department of Medical Statistics, section Molecular Epidemiology, Leiden University Medical Center, PO Box 9600, 2300 RC Leiden, The Netherlands, ⁴Netherlands Consortium of Healthy Aging (NCHA).

J Am Geriatr Soc. 2009 Sep; 57(9):1634-7.



Abstract

The aim of this study was to assess the risk of mortality of nonagenarian siblings compared to sporadic nonagenarians and to assess the prevalence of morbidity in the offspring compared to the partners thereof. We recruited 991 nonagenarian siblings derived from 420 Caucasian families, 1365 of their offspring and 621 of the partners thereof. In the Leiden 85-plus Study, 599 subjects aged 85 years were included of which 275 attained the age of 90 years (sporadic nonagenarians). All nonagenarians siblings (2.7 ± 1.4 years, mean \pm SD) and sporadic nonagenarians (3.0 ± 1.5 years) were followed for mortality. Information on medical history and medication use was collected for offspring and their partners. Nonagenarian siblings displayed a 41% lower risk of mortality ($p < 0.001$) compared to sporadic nonagenarians. Compared to their partners, the offspring of nonagenarian siblings displayed a lower prevalence of myocardial infarction (2.4% vs. 4.1%, $p = 0.03$), hypertension (23.0% vs. 27.5%, $p = 0.01$), diabetes mellitus (4.4% vs. 7.6%, $p = 0.004$) and use of cardio-vascular medication (23.0% vs. 28.9%, $p = 0.003$).

The lower mortality rate of nonagenarian siblings and lower prevalence of morbidity in their middle-aged offspring reinforce the notion that resilience against disease and death have similar underlying biology that is determined by genetic or familial factors.

Introduction

In Western societies, life expectancy has increased dramatically over the last century, but striking inter-individual differences in life expectancy remain ¹. Moreover, although rare examples of exceptional healthy longevity do exist, generally not all of the years that have been gained are spent in good health. Ample evidence has shown that healthy longevity is determined by a mix of genetic, environmental and chance elements. An increasing effort is currently being put in identifying the genetically determined pathways and mechanisms of healthy longevity in humans, as these might provide targets for specific interventions aimed at preservation of disease-free longevity.

The contribution of genetic factors to healthy longevity has been estimated to be rather modest (approximately 20-30%), but was shown to become increasingly important ² and specific ³ at advanced ages. Studies aimed at understanding the genetics of human longevity have thus far preferentially studied the elite of exceptional longevity, such as centenarians or the even more elite "supercentenarians" that survive 110-plus years. In these studies, it was shown that compared to offspring of parents who had died at average age, offspring of centenarians displayed a lower prevalence ⁴ and incidence ⁵ of in particular cardiovascular disease (including hypertension and diabetes mellitus), as well as a later onset of these diseases ⁶ translating in a lower mortality risk ⁷. Centenarians were also shown to have a healthier lifestyle compared to control groups, and may have transmitted part of these habits to their offspring ⁸. These results raise the question how much of the enhanced survival and health in elite cases of exceptional longevity is determined by either genetic or lifestyle factors. Comparable to the risk of developing common and rare diseases, such as breast cancer or hypercholesterolemia, the odds of exceptional longevity also runs in families ⁹.

We aim at identifying genetic determinants of healthy longevity in nonagenarians siblings enriched for heritable influences on morbidity and mortality. Therefore, we designed the Leiden Longevity Study in which we specifically recruited families based on proband siblings that both exhibit exceptional longevity ⁹ instead of the recruitment of families based on sporadic proband cases of exceptional longevity ^{10, 11}. Here, we compare the mortality risk of 991 nonagenarian siblings to that of 275 sporadic nonagenarians. Next, we assess disease prevalence in the offspring of nonagenarian siblings (n=1365) compared to the partners (n=621) thereof.

Materials and methods

Leiden Longevity Study

In the Leiden Longevity Study, 420 families were recruited consisting of long-lived Caucasian siblings together with their offspring and the partners thereof⁹. In the Netherlands, there is no central registry of longevity. In 2002, only 0.5% the Dutch population was aged 89 years or older for males and 91 years or older for females. Long-living siblings fulfilling these age-criteria are even more rare and estimated to represent far less than 0.1% of the Dutch population. To recruit as much as possible long-living siblings within a fixed time window (July 2002-May 2006), we used the following strategy. A randomly chosen 80% (398 out of 496) of the municipalities in the Netherlands were approached and asked for the following information: names and addresses of all inhabitants aged 89 years or older for males and 91 years or older for females, as well as the names and birth dates of their parents. We received the requested information from 375 of the 398 municipalities. Next, by matching the inhabitants thus identified on the names and birth dates of both of their parents by means of a computer algorithm, we identified 2193 potential nonagenarian siblings. Approximately 1650 nonagenarian siblings were contacted and 991 nonagenarian siblings derived from 420 families of Caucasian descent agreed to participate and donate a blood sample (participation rate: app. 60%). Within the same time window, for each nonagenarian included in the Leiden Longevity Study, we also approached the offspring and the partners thereof for case control studies. Of the electable offspring cohort (n=2847), 1705 agreed to participate and donate a blood sample (participation rate: 60%) and of the app.1306 partners thereof, 760 agreed to participate and donate a blood sample (participation rate: app. 58%). There were no selection criteria on health or demographic characteristics. For all subjects, blood samples were taken at baseline for extraction of DNA, RNA and the determination of non-fasted serum and plasma parameters. Between November 2006 and May 2008, we collected additional information and biomaterials from the generation of offspring and partners, including self-reported information on life style, bodily measures, socio-economic status, perceived health, physical activity, number of children and dietary intake. Information on medical history was requested from the participants' treating physicians and information on medication use was requested from the participants' pharmacist. The Medical Ethical Committee of the Leiden University Medical Centre approved the study and informed consent was obtained from all subjects.

The Leiden 85-plus Study

In the Leiden 85-Plus Study, a prospective, population-based study of all individuals aged 85 years (birth cohort 1912-1914) and living in Leiden, the Netherlands, 599 subjects were enrolled between September 1997 and September 1999¹². Of the Leiden 85-plus cohort, 275 subjects

survived to the age of 90 years. The Medical Ethical Committee of the Leiden University Medical Centre approved the study and informed consent was obtained from all subjects.

Statistical analysis

Distributions of continuous variables were examined for normality and logarithmically transformed, when appropriate. Geometric means (with 95% confidence intervals (CI)) are reported for transformed variables. All differences between offspring and partner categories were assessed with the use of linear regression, adjusted for sex, age, and correlation of sibling data using robust standard errors. Mortality analyses were performed with a sex-adjusted, left censored Cox proportional hazards model, to correct for late entry into the data set according to age. The Statistical Package for the Social Sciences (SPSS) program for Windows, version 14.0, and STATA version 10.0 were used for data analysis.

Results

Enrolment and baseline characteristics of participants

We previously recruited 420 families, consisting of 991 long-lived Caucasian siblings together with their offspring and the partners thereof in the Leiden Longevity Study. For 2465 of the offspring and their partners, non-fasted serum samples taken at baseline were available for the determination of endocrine and metabolic parameters. Between November 2006 and May 2008, for 2235 of the offspring and their partners, information on medical history was obtained from the participants' treating physicians (response: 90.7%). For 2255 of the offspring and their partners, information on the use of medication was obtained from the participants' pharmacist (response: 91.5%). For the present study, for a total of 1986 of the offspring and their partners, information on medical history and information on medication use were available (inclusion: 80.4%). Based on self-reported information from questionnaires, the offspring and partners did not differ for any major indicators of lifestyle, including current smoking (13.7% versus 15.6%, $p=0.24$), self-reported body mass index (BMI) (25.4 versus 25.6, $p=0.26$) and level of education (low level: 43.0 % versus 45.9 %, $p=0.16$; moderate level: 22.5 % versus 22.9 %, $p=0.87$; high level: 34.5 % versus 31.2 %; $p=0.10$).

Mortality characteristics of the long-lived siblings

After a mean (\pm standard deviation (SD)) follow-up of 2.65 (\pm 1.37) years, 43.1% of the nonagenarians with the familial longevity phenotype from the Leiden Longevity Study had died, while after a mean (SD) follow-up of 3.04 (\pm 1.51) years, 62.2 % of the nonagenarians with the sporadic longevity phenotype had died. At old age, the nonagenarian siblings displayed a 0.59

(95% Confidence Interval (CI): 0.45-0.71, $p < 0.001$, **table 1** and **figure 1**) lower mortality risk compared to sporadic nonagenarians.

Table 1. Old age mortality in familial nonagenarians compared to sporadic nonagenarians

	Sporadic nonagenarians (n=275)	Familial nonagenarians (n=991)
Demographics		
Age, median (IQR)*	90 (90.0-90.0)	93.4 (91.5-94.9)
Females, No. (%)	199 (72.4%)	619 (62.5%)
Mortality		
HR (95% CI)†	1 (ref)	0.59 (0.46-0.71)

*Age is presented as median with interquartile range.

†Mortality risk is presented as hazard ratio (HR) with 95% confidence interval (CI).

Disease, medication use and anthropometric and metabolic characteristics in offspring and partners

In the group of 1986 subjects (**table 2**), a significantly lower disease prevalence was observed in the offspring compared to their partners for myocardial infarction (2.4% vs. 4.1%, $p=0.03$), hypertension (23.0% vs. 27.5%, $p=0.01$), diabetes mellitus (4.4% vs. 7.6%, $p=0.004$) and use of cardio-vascular medication (23.0% vs. 28.9%, $p=0.003$), including glucose lowering agents, anti-hypertensives and lipid lowering agents, but not anti-platelet agents (**table 2**).

Discussion

The majority of studies into human longevity have thus far focused on centenarians. Here, we show that selection for nonagenarian siblings leads to the inclusion of families that exhibit lower mortality rate at high ages and a better preservation of health at middle age compared to groups of age- and sex-matched controls. This observation indicates that resilience against disease and death may have similar underlying biological mechanisms that are influenced by genetic/familial factors.

Table 2. Comparison of demographics, prevalence of disease and medication use between offspring and partners for males and females combined (n=1986)

	Offspring (n = 1365)	Partners (n = 621)	P-value
Demographics			
Age – yr	59.19 (54.97 - 64.02)	58.88 (54.31 - 63.63)	0.06
Females – no. (%)	732 (53.6)	354 (57.0)	0.16
Prevalence of disease			
Myocardial infarction – no. (%)	32 (2.4)	25 (4.1)	0.03
Stroke – no. (%)	47 (3.5)	19 (3.1)	0.87
Hypertension – no. (%)	307 (22.9)	168 (27.6)	0.009
Diabetes mellitus – no. (%)	59 (4.4)	46 (7.6)	0.004
Malignancies – no. (%)	115 (8.5)	44 (7.2)	0.43
Chronic obstructive pulmonary disease – no. (%)	49 (3.6)	25 (4.1)	0.50
Rheumatoid arthritis – no. (%)	21 (1.6)	4 (0.7)	0.06
Medication use			
Cardiovascular medication – no. (%)	316 (23.2)	180 (29.0)	0.004
-Glucose lowering agents – no.(%)	23 (1.7)	22 (3.5)	0.02
-Antihypertensive agents – no. (%)	223 (16.3)	142 (22.9)	<0.001
-Lipid lowering agents – no. (%)	107 (7.8)	69 (11.1)	0.01
-Acetylsalicylic acid – no. (%)	69 (5.1)	37 (6.0)	0.22
Thyroid medication – no. (%)	37 (2.7)	15 (2.4)	0.62
Growth hormone – no. (%)	0 (0.0)	0 (0.0)	-

P-values were calculated using a linear regression model, adjusted for age and sex. Age is presented as median with interquartile range. Diabetes mellitus is defined as reported by the general practitioner. Glucose lowering agents are defined as insulins and analogues, oral blood glucose lowering drugs. Antihypertensive agents are defined as diuretics, beta blocking agents, calcium channel blockers, agents acting on the renin-angiotensin system. Lipid lowering agents are defined as fibrates, niacin, bile acid sequestrants, HMG-COA reductase inhibitors. Thyroid medication is defined as thyroid hormones, anti-thyroid preparations, iodine therapy.

Previously ⁹, we showed that standardized mortality ratios compared with the general Dutch population were app. 30% lower for all first degree family members of the proband siblings from the first 100 families that were included in the Leiden Longevity Study. Here, we extend those findings by showing that the survival benefit observed earlier is maintained up to the highest age categories (89-104 years) in the complete cohort of nonagenarian siblings (derived from 420 families) as compared to the survival of sporadic nonagenarians from the Leiden 85-plus Study using prospective survival analysis. This result is in line with that of another study, showing that the survival advantage of siblings of centenarians persists into the highest age categories ^{2, 13}. In the first phase of life siblings share many environmental factors, including socioeconomic status, life styles and region of residence, but these are likely to diverge as they grow older. Because the influence of genetic factors has been shown to become increasingly important at advanced ages, the observation that the survival advantage extends up to the highest age category (89-104 years in the nonagenarian siblings), strongly suggests that genetic factors could play a role in longevity in these families.

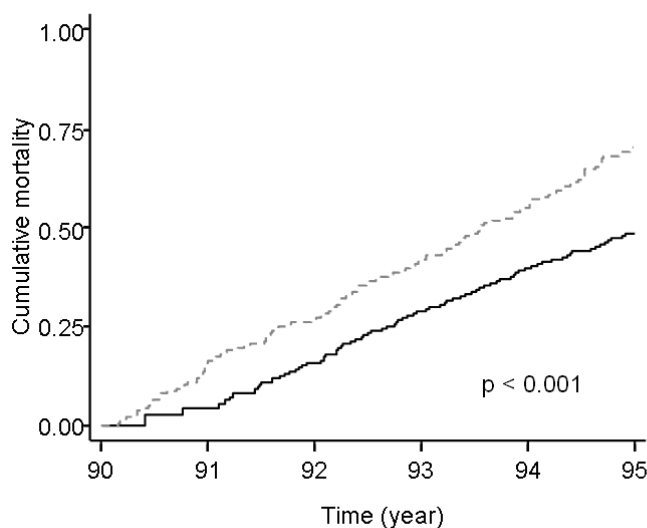

Figure 1. Cumulative mortality from age 90 through age 95 among familial nonagenarians (n=991) and sporadic nonagenarians (n=275) for males and females combined. Solid line indicates familial longevity, dashed line indicates sporadic.

Previous studies have shown that the offspring of centenarians as well as offspring from one or two parents who survived to the age of 85 years have a lower prevalence of diseases when compared to control subjects from the same birth cohort whose parents died at younger ages ⁶. However, when comparing offspring from one or two parents who survived to 'old' age to offspring of parents who died at 'young' age, significant differences were observed in major cardiovascular risk factors between these groups, including years of education and current smoking, which complicates disentangling the precise contribution of genetic, behavioral and

lifestyle factors to the observed longevity phenotype.¹⁴ Likewise, centenarians were also shown to generally avoid bad lifestyle habits, and their offspring may have copied their behavior⁸.

As a strategy to minimize the potential confounding effects of differences in (adult) environment, we⁹ have deliberately chosen to compare offspring from long-lived cases to their partners. Although the amount of cohabitation may have been variable, the lack of differences between these two groups in major indicators of lifestyle, including estimates for body mass index, current smoking, and prevalence of COPD, a smoking related disease, may be explained by the shared adult environment of the couples.

The decreased prevalence of myocardial infarctions, diabetes mellitus and hypertension in the offspring of nonagenarian siblings as compared to their partners is thus more likely to be due to genetic influences rather than environmental differences between the two groups. This result is in line with those of another study, in which significant lower prevalence was observed for diabetes mellitus and myocardial infarction in 180 offspring from Ashkenazi Jewish centenarians as compared to 75 of their partners in the absence of differences in BMI and percentage of body fat between these two groups¹⁰.

In conclusion, by recruiting nonagenarian siblings in the Leiden Longevity Study the current study was enriched for subjects with a familial predisposition for longevity. Early features of healthy longevity appear already at middle age in these families, setting the stage for further analyses on how to live healthier for longer. Future research in this study population will focus on unraveling the genetic determinants and biochemical pathways and mechanisms that contribute to healthy longevity, as these might provide targets for specific interventions aimed at preservation of disease-free longevity in the population at large.

Acknowledgements

The LLS was funded by the Innovation Oriented research Program on Genomics (SenterNovem; IGE01014 and IGE5007), the Centre for Medical Systems Biology (CMSB), the Netherlands Genomics Initiative/Netherlands Organization for scientific research (NGI/NWO; 05040202 and 050-060-810) and the EU funded Network of Excellence Lifespan (FP6 036894). We thank all participants of the Leiden Longevity Study for their consistent cooperation, as well all participating general practitioners and pharmacists, the secretary staff (Meriam H van der Star, Ellen H Bemer-Oorschot) and research nurses (Corrie J Groenendijk), data managers (Karin H Herbschleb) for their expert contribution. We also thank Karin H Herbschleb for her contribution to the data-analysis.

Chapter 2

Author contributions: RGW and PES conceived and directed the project. DvH contributed to the design and conduct of the project, to the data analysis and drafted the manuscript, MP contributed to the conduct of the project, performed the data analysis and drafted the tables and figures, MF, GJB contributed to the design and conduct of the project, MB and BT contributed to the design of the project, SPM contributed to the conduct of the project, AJdC contributed to the design and conduct of the project and to the data analysis. All authors contributed to the interpretation of the data, critically reviewed the report and approved the final version.

Reference List

- (1) Oeppen J, Vaupel JW. Demography. Broken limits to life expectancy. *Science* 2002 May 10;296(5570):1029-31.
- (2) von Hjelmborg JB, Iachine I, Skytthe A et al. Genetic influence on human lifespan and longevity. *Hum Genet* 2006 April;119(3):312-21.
- (3) Passarino G, Montesanto A, Dato S et al. Sex and age specificity of susceptibility genes modulating survival at old age. *Hum Hered* 2006;62(4):213-20.
- (4) Terry DF, Wilcox M, McCormick MA, Lawler E, Perls TT. Cardiovascular advantages among the offspring of centenarians. *J Gerontol A Biol Sci Med Sci* 2003 May;58(5):M425-M431.
- (5) Adams ER, Nolan VG, Andersen SL, Perls TT, Terry DF. Centenarian offspring: start healthier and stay healthier. *J Am Geriatr Soc* 2008 November;56(11):2089-92.
- (6) Terry DF, Wilcox MA, McCormick MA et al. Lower all-cause, cardiovascular, and cancer mortality in centenarians' offspring. *J Am Geriatr Soc* 2004 December;52(12):2074-6.
- (7) Terry DF, Wilcox MA, McCormick MA et al. Lower all-cause, cardiovascular, and cancer mortality in centenarians' offspring. *J Am Geriatr Soc* 2004 December;52(12):2074-6.
- (8) Galioto A, Dominguez LJ, Pineo A et al. Cardiovascular risk factors in centenarians. *Exp Gerontol* 2008 February;43(2):106-13.
- (9) Schoenmaker M, de Craen AJ, de Meijer PH et al. Evidence of genetic enrichment for exceptional survival using a family approach: the Leiden Longevity Study. *Eur J Hum Genet* 2006 January;14(1):79-84.
- (10) Atzmon G, Schechter C, Greiner W, Davidson D, Rennert G, Barzilai N. Clinical phenotype of families with longevity. *J Am Geriatr Soc* 2004 February;52(2):274-7.
- (11) Barzilai N, Atzmon G, Schechter C et al. Unique lipoprotein phenotype and genotype associated with exceptional longevity. *JAMA* 2003 October 15;290(15):2030-40.

Chapter 2

- (12) von Faber M, Bootsma-van der Wiel A, van Exel E et al. Successful aging in the oldest old: Who can be characterized as successfully aged? *Arch Intern Med* 2001 December 10;161(22):2694-700.
- (13) Perls TT, Wilmoth J, Levenson R et al. Life-long sustained mortality advantage of siblings of centenarians. *Proc Natl Acad Sci U S A* 2002 June 11;99(12):8442-7.
- (14) Terry DF, Evans JC, Pencina MJ et al. Characteristics of Framingham offspring participants with long-lived parents. *Arch Intern Med* 2007 March 12;167(5):438-44.

Chapter 3: Favorable glucose tolerance and lower prevalence of metabolic syndrome in non-diabetic offspring of nonagenarian siblings: the Leiden Longevity Study

Maarten P. Rozing^{1,4}, Rudi G.J. Westendorp^{1,4}, Anton J.M. de Craen^{1,4}, Marijke Frölich², Moniek C.M. de Goeij¹, Bastiaan T. Heijmans^{3,4}, Marian Beekman^{3,4}, Carolien A. Wijnsman^{1,4}, Simon P. Mooijaart^{1,4}, Gerard-Jan Blauw¹, P. Eline Slagboom^{3,4}, and Diana van Heemst^{1,4}, on behalf of the Leiden Longevity Study (LLS) Group

From the ¹Department of Gerontology and Geriatrics, ²Department of Clinical Chemistry, ³Department of Medical Statistics, section Molecular Epidemiology, Leiden University Medical Center, PO Box 9600, 2300 RC Leiden, The Netherlands, ⁴ Netherlands Consortium of Healthy Aging (NCHA).

J Am Geriatr Soc. 2010 Mar; 58(3):564-9



Abstract

The involvement of the insulin/IGF-1 signaling pathway in the regulation of lifespan has been demonstrated in numerous model organisms. It has been suggested that insulin sensitivity is at play in human longevity as well. The aim of this study was to explore measures of glucose metabolism in families with exceptional longevity. Therefore, we performed an oral glucose tolerance test in a group of 121 offspring of nonagenarian siblings, who were enriched for familial factors promoting longevity, in comparison to a group of 113 of their partners. All subjects were non-diabetics and body composition was similar between the two groups. The group of offspring had a lower prevalence of metabolic syndrome ($p=0.031$), similar body composition and lower mean fasting blood glucose levels (4.99 vs. 5.16 mmol/L; $P = 0.010$), lower mean fasting insulin levels (5.81 vs. 6.75 mU/L; $P = 0.039$), a higher mean homeostasis model assessment of insulin sensitivity (HOMA of 0.78 vs. 0.65, $P = 0.018$) and a more favorable glucose tolerance (mean area under the curve for glucose (13.2 vs. 14.3; $P = 0.007$) when compared to the group of their partners. No significant differences were observed between the group of offspring and their partners in beta cell function (insulinogenic index of 13.6 vs. 12.5; $P = 0.38$). Our findings imply that a preserved glucose tolerance and insulin action is already present at middle-age in offspring of familial nonagenarians.

Introduction

Healthy longevity is determined by a mix of genetic, environmental and chance elements. An increasing effort is currently being put in identifying the genetically determined pathways and mechanisms of healthy longevity in humans, as these might provide targets for specific interventions aimed at preservation of disease-free longevity. Of the genetically determined pathways that have been implicated in longevity in model organisms, the evolutionary conserved insulin/insulin-like growth factor-1 signaling (IIS) pathway clearly stands out in current literature. Mutations in the insulin/IGF-1 signaling pathway have been associated with longevity in a variety of model organisms, including nematodes, flies, and rodents ¹⁻⁹. In mammals, a hallmark phenotype shared by many of the long-lived mutants ¹⁰, including those with genetically induced insulin-like growth factor-1 (IGF-1) resistance is their preserved insulin sensitivity and/or their low fasting blood glucose concentrations. Strikingly, preserved insulin sensitivity/glucoregulation is also intimately associated with the dietary restriction mediated decreased mortality recently observed in non-human primates ¹¹.

Recently, we found that the offspring of familial nonagenarians showed a lower prevalence of myocardial infarction, hypertension and diabetes, suggesting that they are protected against the combination of cardio-vascular risk factors that constitute the metabolic syndrome¹². Current estimates suggest that the population-attributable fraction for the metabolic syndrome is approximately 6-7% for all-cause mortality, 12-17% for cardiovascular disease, and 30-52% for diabetes ¹³. It is unclear which of the risk factors that constitute the metabolic syndrome contributes most strongly to these effects, although it had been suggested that either body mass index (BMI) or insulin sensitivity might play such a major role ^{13, 14}.

Previous reports have shown that the offspring of centenarians had a moderately lower prevalence of metabolic syndrome ¹⁵. Moreover, it has been reported that centenarians showed a preserved insulin sensitivity, comparable to that of healthy young subjects ¹⁶.

However, comparative cross-sectional studies involving long-lived subjects are hampered by the lack of proper controls, making it difficult to disentangle the precise contribution of genetic and lifestyle factors to the observed phenotype. We designed the Leiden Longevity Study in order to identify genetic determinants of healthy longevity in nonagenarian siblings and their offspring, which are enriched for heritable influences on morbidity and mortality ¹⁷. In the Leiden Longevity Study, we included 420 families based on proband siblings that both exhibit exceptional longevity. We also included the middle-aged offspring of the nonagenarian siblings and the partners thereof. Recently, we found that compared to their partners, the offspring of

nonagenarian siblings had a lower prevalence of myocardial infarction, hypertension and diabetes¹⁸ as well as lower non-fasting serum glucose levels¹⁹. As the offspring and their partners by and large share the same environment, it is unlikely that the observed differences between offspring and partners were confounded by environmental factors. For example, the prevalence of Chronic Obstructive Pulmonary Disease (COPD), which is almost entirely caused by behavioral factors, was similar among both groups.

The purpose of this study is twofold. First, to compare the prevalence of metabolic syndrome and its individual risk components between offspring of nonagenarian siblings and their partners. Secondly, to further explore the differences in glucose metabolism between offspring of nonagenarian siblings and their partners. For the latter, oral glucose tolerance was compared between a group of offspring of nonagenarian siblings and their partners, after exclusion of diabetes patients.

Materials and methods

The Leiden Longevity Study

The recruitment of 420 families in the Leiden Longevity Study has been described before¹⁷. Families were recruited if at least two long lived siblings were alive and fulfilled the age-criterion of 89 years or older for males and 91 year or older for females. There were no selection criteria on health or demographic characteristics. For 2465 of the offspring of long-lived siblings and their partners, non-fasting serum samples were taken at baseline for the determination of endocrine and metabolic parameters. Additional information was collected from the generation of offspring and partners, including self-reported information on life style, information on medical history from the participants' treating physicians and information on medication use from the participants' pharmacists.

For the present study, a subgroup of 190 middle-age couples, living in close proximity to the Research Center (traveling distance less than 45 minutes by car) were invited to come fasted to the research Center. Of these, 137 middle-aged couples, each consisting of an offspring of a nonagenarian sibling and the partner thereof, agreed to participate. Of the 137 offspring, two participants were excluded because of current use of glucose lowering agents, nine participants because of a previous history of diabetes mellitus and five because of unreliable oral glucose tolerance test results. Of the 137 partners, six participants were excluded because of current use of glucose lowering agents, seven because of a previous history of diabetes mellitus, ten because of unreliable oral glucose tolerance test results and one because of non-compliance to the fasting

state. The Medical Ethical Committee of the Leiden University Medical Centre approved the study and informed consent was obtained from all subjects.

Anthropometric measurements

Waist circumference was measured halfway between the lower costal margin and the iliac crest with subjects in standing position. Hip circumference was measured at the level of the great trochanters. Body composition was determined by a bioelectrical impedance analysis. Measures of blood pressure, heart rate and temperature were taken at two occasions and averaged for analysis. Glucose tolerance was assessed by a two hour oral glucose tolerance test, conducted with a standard loading dose of 75g glucose/300 ml water, and venous blood samples drawn at time points of zero, 30, 60 and 120 minutes after glucose loading. Data on frequency, intensity and duration of exercise were obtained using the International Physical Activity Questionnaire (Ipaq).²⁰ Data were available for only 85 offspring (70.2%) and 80 partners (70.8%).

Biochemical analysis

All serum measurements were performed with fully automated equipment. For insulin the Immulite 2500 from DPC (Los Angeles, CA, USA) was applied. The coefficient of variation (CV) for this measurement was below 8%. For glucose, total cholesterol, high-density lipoprotein (HDL)-cholesterol, triglycerides, the Hitachi Modular P 800 from Roche, Almere, the Netherlands was applied. CV's of these measurements were below 5 %. For low-density lipoprotein (LDL)-cholesterol the Friedewald formula was applied.

Definitions

Metabolic syndrome was defined according to the criteria of the Third Report of the National Cholesterol Education Program:²¹ Waist > 102 cm (males), waist > 88 cm (females), Triglyceride ≥ 1.69 mmol/L, HDL cholesterol <1.04 mmol/L (men) or < 1.29 mmol/L (women), Fasting glucose ≥ 6.1 mmol, Systolic blood pressure ≥ 130 mmHg or diastolic blood pressure ≥ 85 or treated hypertensive.

Areas under the curves obtained in the oral glucose tolerance test were calculated by the trapezoid rule; the homeostasis model assessment (HOMA) of insulin sensitivity was calculated by dividing 22.5 by the product of the fasting plasma insulin level (in mU/L) and the fasting plasma glucose level (in mmol/L)²². Insulinogenic index was calculated as the $\Delta_{30, 0 \text{ minutes}}$ insulin (mU/L) divided by the $\Delta_{30, 0 \text{ minutes}}$ glucose (mmol/L).

Statistical analyses

Distributions of continuous variables were examined for normality and logarithmically transformed when appropriate and used in all calculations. Geometric means (with 95% confidence intervals (CI)) are reported for transformed variables (serum insulin levels, area under the curve for insulin and insulinogenic index). Differences between offspring and partner categories were assessed with the use of linear mixed models or with logistic regression, adjusted for age and body mass index and correlation of sibling relationship. Differences in age between the group of offspring and partners were tested using a Mann-Whitney rank sum test. Differences in smoking behavior and sex distribution between the group of offspring and partners were calculated using a Chi-square test. The Statistical Package for the Social Sciences (SPSS) program for Windows, version 16.0 or STATA, version 10.1 were used for data analysis.

Results

Table 1 displays the baseline characteristics of the study populations after exclusion of diabetic participants (see methods section). In total 121 offspring and 113 partners were included in the study. The offspring group was slightly yet non-significantly older than the group of partners (median age of 63.9 years and 62.2 respectively; $p = 0.33$). Current smoking status was not different between the two groups: 11 current smokers (9.2%) in the offspring group versus 12 current smokers (10.6%) in the partners group ($p = 0.83$). Body mass index and the percentage of body fat were similar between the offspring group and partner group. In the group of offspring we observed a lower proportion of subjects using lipid lowering agents than in the group of partners. Estimated mean fasting total cholesterol and fasting LDL cholesterol levels were higher in the group of offspring than in the group of partners. However, exclusion of subjects using lipid lowering agents, diminished the difference in mean fasting total cholesterol and fasting LDL levels between offspring and partners. Furthermore, we found that the group of offspring had lower levels of fasting glucose, fasting insulin, a lower proportion of subjects using antihypertensive agents and lower systolic blood pressure.

Table 1. Baseline Characteristics of Offspring and Partners

	Offspring	Partners	P-value
Number participants (N, %)	121 (51.7%)	113 (48.3%)	
Females (N, %)	62 (51.2%)	59 (52.2%)	
Age (year)	63.9 (58.9 – 67.9)	62.2 (58.9 – 67.6)	0.33
Physical activity (Met-S/ week)	712.6 (569.9 – 891.1)	768.4 (610.5 – 967.2)	0.64
Smoking	11 (9.2%)	12 (10.6%)	0.83
Fat percentage	31.0 (29.7 – 32.4)	30.5 (29.1 – 31.9)	0.49
Body Mass Index (kg/m ²)	26.2 (25.5 – 26.9)	26.4 (25.7 – 27.2)	0.62
Waist (cm.)	97.7 (95.8 – 99.6)	99.2 (97.3 – 101.2)	0.18
Lipid lowering agents (N, %)	7 (5.8%)	20 (17.7%)	0.004
Total cholesterol (mmol/L)	5.54 (5.37 – 5.72)	5.14 (4.96 – 5.32)	0.001
Total cholesterol (mmol/L)*	5.58 (5.41 – 5.75)	5.35 (5.16 – 5.56)	0.067
Triglycerides (mmol/L)	1.25 (1.15 – 1.36)	1.28 (1.17 – 1.39)	0.74
Triglycerides (mmol/L)*	1.25 (1.14 – 1.36)	1.27 (1.16 – 1.39)	0.77
HDL cholesterol (mmol/L)	1.55 (1.48 – 1.63)	1.48 (1.40 – 1.56)	0.17
HDL cholesterol (mmol/L)*	1.56 (1.48 – 1.64)	1.49 (1.40 – 1.56)	0.19
LDL cholesterol (mmol/L)	3.37 (3.21 – 3.54)	3.03 (2.86 – 3.20)	0.002
LDL cholesterol (mmol/L)*	3.40 (3.25 – 3.56)	3.24 (3.06 – 3.41)	0.14
Fasting glucose (mmol/L)	4.99 (4.89 – 5.08)	5.17 (5.08 – 5.27)	0.006
Fasting insulin (U/L)	5.61 (4.93 – 6.37)	6.65 (5.84 – 7.59)	0.034
Antihypertensive medication (N, %)	26 (21.5%)	38 (33.6%)	0.016
Systolic blood pressure (mm Hg)	138.9 (135.4 – 142.5)	144.5 (140.9 – 148.2)	0.030
Diastolic blood pressure (mm Hg)	82.9 (81.1 – 84.7)	83.6 (81.7 – 85.5)	0.57

Data are presented as estimated mean value with 95% confidence interval. Results were adjusted for age and sex (except age). * Analyses after exclusion of subjects using lipid-lowering agents. P values for antihypertensive medication and lipid lowering agents were calculated using a logistic regression model adjusted for age and sex. Data on physical activity were available for 85 offspring and 80 partners. HDL: high-density lipoprotein; LDL: low-density lipoprotein.

Table 2. Number of non-diabetic participants who fulfill metabolic syndrome criteria for offspring and partners

	Offspring (N=121)	Partners (N=113)	p-value
Metabolic syndrome	25 (20.7%)	36 (31.9%)	0.031
Waist*	68 (56.2%)	70 (61.9%)	0.40
Triglyceride [†]	29 (24.0%)	29 (25.7%)	0.73
HDL cholesterol [‡]	16 (13.2%)	27 (23.9%)	0.017
Fasting glucose [§]	1 (0.8%)	10 (8.8%)	0.019
Blood pressure [¶]	83 (68.6%)	86 (76.1%)	0.050

* Waist > 102 cm (males), waist > 88 cm (females), [†] Triglyceride \geq 1.69 mmol/L, [‡] HDL cholesterol <1.04 mmol/L (men) or < 1.29 mmol/L (women), [§] Fasting glucose \geq 6.1 mmol/L,

[¶] Systolic blood pressure \geq 130 mmHg or diastolic blood pressure \geq 85 or treated hypertensive. HDL: high-density lipoprotein.

Table 2 shows the prevalence of metabolic syndrome and its individual components for the group of offspring and the group of partners. The group of offspring showed a lower prevalence of metabolic syndrome than the group of partners (p=0.031). Moreover, in the group of offspring a lower proportion of subjects fulfilled the criteria for the glucose component (p=0.019) and the HDL component (p=0.017) when compared to the group of partners. In contrast, no differences were observed between offspring and partners for obesity related criteria, including waist and triglycerides. **Figure 1** displays the number of metabolic syndrome components for offspring and partners.

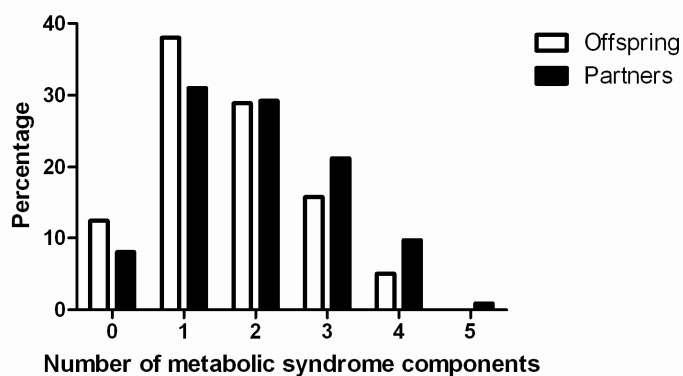

Figure 1. Distribution of number of metabolic syndrome components for offspring and partners.

To determine possible differences in peripheral glucose metabolism and insulin sensitivity between the groups of offspring and partners, participants underwent an oral glucose tolerance

test. Results of the oral glucose tolerance test are depicted in **figure 2**, in which all analyses were adjusted for BMI.

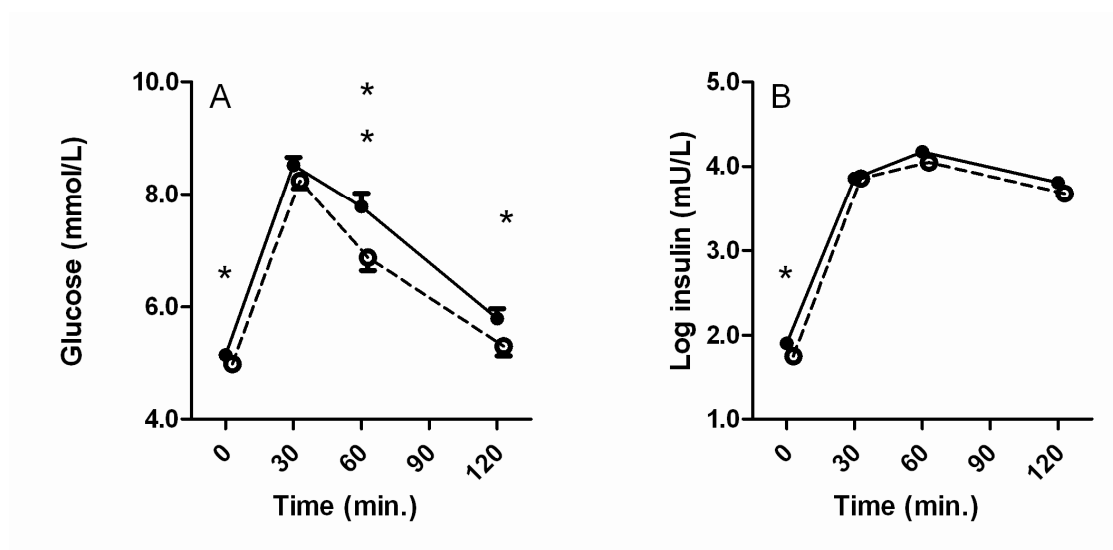

Figure 2. Results of oral glucose tolerance test for offspring and partners. Figure 2A depicts serum glucose concentrations (mmol/L) for offspring (open circles) and partners (closed circles) for both sexes combined at 0, 30, 60 and 120 minutes (min.). Figure 2B depicts log serum insulin concentrations (mU/L) for offspring (open circles) and partners (closed circles) for both sexes combined at 0, 30, 60 and 120 minutes (min.). Data were adjusted for sex, age and body mass index. * denotes P value < 0.05. ** denotes P value < 0.01.

Results of the oral glucose tolerance test are presented in **table 3** for the group of offspring and the group of partners. In the group of offspring as compared to the group of partners, fasting glucose levels were lower (4.99 mmol/L versus 5.16 mmol/L, $P = 0.010$) and the area under the curve for glucose was comparatively smaller (13.2 vs. 14.3; $P = 0.007$). Likewise, fasting insulin levels were lower in the group of offspring compared to the group of partners (5.81 mU/L vs. 6.75 mU/L; $P = 0.039$). The area under curve for insulin was non-significantly lower among the offspring group versus the partner group (92.1 vs. 100.7; $P = 0.18$). Insulin sensitivity as assessed by the homeostasis model was higher among the group of offspring in comparison to the group of partners (0.78 vs. 0.65; $P = 0.018$). No differences were observed between the two groups for the insulinogenic index, an approximate measure for the pancreatic β -cell function: 13.6 in the offspring group versus 12.5 in the partner group ($P = 0.38$). These differences between the offspring and partner groups were most pronounced in females, while for males a trend towards these differences was observed (**table 3**). All analyses above were adjusted for age and body mass index (and in case of all, for sex). Results were not materially different when analyses were further adjusted for waist hip ratio, percentage of fat mass, current smoking and physical exercise (data not shown).

Table 3. Results of Oral Glucose Tolerance Test for Offspring and Partners.

	Offspring	Partners	P-value
All (n)	121 (100%)	113 (100%)	
Fasting glucose (mmol/L)	4.99 (4.90 – 5.08)	5.16 (5.07 – 5.26)	0.010
Area under the curve glucose	13.2 (12.6 – 13.8)	14.3 (13.7 – 14.9)	0.007
Fasting insulin levels (mU/L)	5.81 (5.20 - 6.51)	6.75 (6.02 - 7.57)	0.039
Area under the curve insulin	92.1 (83.2 - 102.0)	100.7 (90.6 - 111.8)	0.18
HOMA-insulin sensitivity	0.78 (0.69 – 0.88)	0.65 (0.58 – 0.74)	0.018
Insulinogenic index	13.6 (11.8 – 15.7)	12.5 (10.8 – 14.5)	0.38
Females (n)	62 (51.2%)	59 (52.2%)	
Fasting glucose (mmol/L)	4.88 (4.76 - 5.01)	5.13 (5.00 - 5.25)	0.007
Area under the curve glucose	13.2 (12.4 – 14.0)	14.2 (13.4 – 15.1)	0.069
Fasting insulin levels (mU/L)	5.34 (4.55 - 6.28)	7.27 (6.18 - 8.55)	0.007
Area under the curve insulin	92.7 (81.1 - 106.1)	107.0 (93.3 - 122.5)	0.13
HOMA-insulin sensitivity	0.87 (0.73 – 1.03)	0.61 (0.51 – 0.72)	0.003
Insulinogenic index	13.6 (11.5 – 16.2)	13.0 (10.9 – 15.5)	0.73
Males (n)	59 (48.8%)	54 (47.8%)	
Fasting glucose (mmol/L)	5.09 (4.95 - 5.24)	5.19 (5.04 - 5.34)	0.34
Area under the curve glucose	13.3 (12.4 – 14.2)	14.3 (13.4 – 15.3)	0.10
Fasting insulin levels (mU/L)	6.42 (5.56 - 7.41)	6.32 (5.44 - 7.34)	0.89
Area under the curve insulin	92.4 (79.6 - 107.3)	94.7 (80.8 - 111.0)	0.82
HOMA-insulin sensitivity	0.69 (0.59 – 0.81)	0.69 (0.59 – 0.81)	0.97
Insulinogenic index	14.4 (11.2 – 18.3)	12.8 (9.84 – 16.6)	0.46

Data are presented as means with 95% confidence intervals. Results were adjusted for age and body mass index, and in the case of all for age and sex. HOMA: homeostasis model assessment.

Discussion

The purpose of this study was to explore measures metabolic syndrome and differences in glucose metabolism among the middle-aged offspring of nonagenarian siblings which are enriched for heritable influences on longevity, as compared to the control group of their middle-aged partners. We found that the group of offspring had a lower prevalence of metabolic syndrome as compared to the group of partners. When considering the individual components of the metabolic syndrome, the group of offspring showed a lower fraction of subjects fulfilling the

criteria for the HDL component and the glucose component but not of obesity related criteria, including waist and triglycerides, centralizing the role of glucose metabolism in our findings.

With respect to glucose metabolism, we found that the group of offspring had lower fasting blood glucose concentrations and higher HOMA insulin sensitivity when compared to the group of partners thereof. In addition, offspring had a more favorable glucose tolerance than their partners. However, beta cell function as measured by the insulinogenic index was similar between the two groups.

These data are in accordance with earlier studies showing that the offspring of exceptionally long-lived individuals are protected against the combination of cardio-vascular risk factors that constitute the metabolic syndrome ¹⁵. However, while it was shown that offspring of exceptionally long-lived individuals are healthier in many parameters, this has not previously been shown for glucose tolerance. Data from mammalian models show an association in diverse mutants (including those with mutations causing growth hormone/IGF-1 resistance) between enhanced lifespan and preserved insulin sensitivity i.e enhanced insulin action. Taken together, these findings suggest that in humans as in mammals decreased insulin signaling is not associated with exceptional longevity as it is in non-mammalian models.

These findings are a crucial extension of our initial observations of lower non-fasted blood glucose levels and the lower prevalence of diabetes in offspring of nonagenarian siblings compared to their partners ^{18, 19}. Moreover our findings add to the previous observations of a preserved glucose tolerance and insulin action in healthy centenarians ¹⁶ by demonstrating that a beneficial glucose metabolism is already present at middle-age in offspring of familial nonagenarians.

The lower prevalence of metabolic syndrome and better glucose handling in the offspring of nonagenarian siblings which we observed in the current study might have contributed to the lower prevalence of cardiovascular disease which we reported in an earlier study ¹⁸. Prior research has demonstrated advantageous cardiovascular risk profiles in middle-aged individuals with long-lived parents compared with those whose parents died younger ^{23, 24}, although in this study significant differences in lifestyle existed between the groups that were compared, including years of education and current smoking, which complicates disentangling the precise contribution of genetic and lifestyle factors to the observed longevity phenotype. As a strategy to minimize the potential confounding effects of differences in environment, we and others have deliberately chosen to compare offspring from long-lived cases to their partners ^{23, 25}.

Chapter 3

In line with previous findings^{26, 27}, our data suggest that differences in metabolic syndrome and glucose tolerance may result not only from environmental factors but also from genetic factors, which are transmitted in families. The lack of difference in the insulinogenic index between the offspring and their partners makes pancreatic β -cell function unlikely to account for the beneficial glucose tolerance in the offspring. As the offspring and their partners by and large share the same environment, it is unlikely that the observed differences between offspring and partners are fully explained by environmental conditions. For example, current smoking behavior and levels of physical activity were similar in both groups. Likewise, body mass index, an important risk factor for the development of insulin resistance was similar among the two groups. In order to identify mechanisms which may be involved in the better glucose handling we are planning to perform clamp studies in a representative subset of offspring and the partners thereof.

In conclusion, we observed a lower prevalence of metabolic syndrome and a favorable glucose tolerance among the offspring of nonagenarian siblings when compared to their partners. The favorable glucose tolerance could not be explained for by differences in body mass index and pancreatic β -cell function. Our findings imply that the preserved glucose tolerance and insulin action is already present at middle-age in offspring from familial nonagenarians.

Acknowledgements

Supported by the Innovation Oriented research Program on Genomics (SenterNovem; IGE01014 and IGE5007), the Centre for Medical Systems Biology (CMSB), the Netherlands Genomics Initiative/Netherlands Organization for scientific research (NGI/NWO; 05040202) and the EU funded Network of Excellence Lifespan (FP6 036894). We thank all participants of the Leiden Longevity Study for their consistent cooperation, as well all participating general practitioners and pharmacists, the secretary staff (Meriam H.G.F. van der Star, Ellen H.M. Bemer-Oorschot) and research nurses (Corrie Groenendijk), data managers (Karin Herbschleb) for their expert contribution.

Reference List

- (1) Bluher M, Kahn BB, Kahn CR. Extended longevity in mice lacking the insulin receptor in adipose tissue. *Science* 2003 January 24;299(5606):572-4.
- (2) Holzenberger M, Dupont J, Ducos B et al. IGF-1 receptor regulates lifespan and resistance to oxidative stress in mice. *Nature* 2003 January 9;421(6919):182-7.
- (3) Johnson TE. Increased life-span of age-1 mutants in *Caenorhabditis elegans* and lower Gompertz rate of aging. *Science* 1990 August 24;249(4971):908-12.
- (4) Kenyon C. A conserved regulatory system for aging. *Cell* 2001 April 20;105(2):165-8.
- (5) Kinney BA, Coschigano KT, Kopchick JJ, Steger RW, Bartke A. Evidence that age-induced decline in memory retention is delayed in growth hormone resistant GH-R-KO (Laron) mice. *Physiol Behav* 2001 April;72(5):653-60.
- (6) Kinney BA, Meliska CJ, Steger RW, Bartke A. Evidence that Ames dwarf mice age differently from their normal siblings in behavioral and learning and memory parameters. *Horm Behav* 2001 June;39(4):277-84.
- (7) Piper MD, Selman C, McElwee JJ, Partridge L. Separating cause from effect: how does insulin/IGF signalling control lifespan in worms, flies and mice? *J Intern Med* 2008 February;263(2):179-91.
- (8) Tatar M, Bartke A, Antebi A. The endocrine regulation of aging by insulin-like signals. *Science* 2003 February 28;299(5611):1346-51.
- (9) van Heemst D, Beekman M, Mooijaart SP et al. Reduced insulin/IGF-1 signalling and human longevity. *Aging Cell* 2005 April;4(2):79-85.
- (10) Longo VD, Finch CE. Evolutionary medicine: from dwarf model systems to healthy centenarians? *Science* 2003 February 28;299(5611):1342-6.
- (11) Colman RJ, Anderson RM, Johnson SC et al. Caloric restriction delays disease onset and mortality in rhesus monkeys. *Science* 2009 July 10;325(5937):201-4.
- (12) Eckel RH, Grundy SM, Zimmet PZ. The metabolic syndrome. *Lancet* 2005 April 16;365(9468):1415-28.

Chapter 3

- (13) Ford ES, DeStefano F. Risk factors for mortality from all causes and from coronary heart disease among persons with diabetes. Findings from the National Health and Nutrition Examination Survey I Epidemiologic Follow-up Study. *Am J Epidemiol* 1991 June 15;133(12):1220-30.
- (14) Sattar N, McConnachie A, Shaper AG et al. Can metabolic syndrome usefully predict cardiovascular disease and diabetes? Outcome data from two prospective studies. *Lancet* 2008 June 7;371(9628):1927-35.
- (15) Atzmon G, Pollin TI, Crandall J et al. Adiponectin levels and genotype: a potential regulator of life span in humans. *J Gerontol A Biol Sci Med Sci* 2008 May;63(5):447-53.
- (16) Paolisso G, Gambardella A, Ammendola S et al. Glucose tolerance and insulin action in healthy centenarians. *Am J Physiol* 1996 May;270(5 Pt 1):E890-E894.
- (17) Schoenmaker M, de Craen AJ, de Meijer PH et al. Evidence of genetic enrichment for exceptional survival using a family approach: the Leiden Longevity Study. *Eur J Hum Genet* 2006 January;14(1):79-84.
- (18) Westendorp RG, van Heemst D, Rozing MP et al. Nonagenarian siblings and their offspring display lower risk of mortality and morbidity than sporadic nonagenarians: The Leiden Longevity Study. *J Am Geriatr Soc* 2009 September;57(9):1634-7.
- (19) Rozing MP, Westendorp RG, Frolich M et al. Human insulin/IGF-1 and familial longevity at middle age. *Aging (Albany NY)* 2009 August;1(8):714-22.
- (20) International Physical Activity Questionnaire (IPAQ) www.ipaq.ki.se last accessed 13-9-2009.
- (21) Third report of the National Cholesterol Education Program (NCEP), Expert Panel on Detection, Evaluation, and Treatment of High Blood Cholesterol in adults (Adult Treatment Panel III) final report. *Circulation* 2002;106:3143-421.
- (22) Matthews DR, Hosker JP, Rudenski AS, Naylor BA, Treacher DF, Turner RC. Homeostasis model assessment: insulin resistance and beta-cell function from fasting plasma glucose and insulin concentrations in man. *Diabetologia* 1985 July;28(7):412-9.
- (23) Barzilai N, Gabriely I, Gabriely M, Iankowitz N, Sorkin JD. Offspring of centenarians have a favorable lipid profile. *J Am Geriatr Soc* 2001 January;49(1):76-9.

- (24) Terry DF, Evans JC, Pencina MJ et al. Characteristics of Framingham offspring participants with long-lived parents. *Arch Intern Med* 2007 March 12;167(5):438-44.
- (25) Heijmans BT, Beekman M, Houwing-Duistermaat JJ et al. Lipoprotein particle profiles mark familial and sporadic human longevity. *PLoS Med* 2006 December;3(12):e495.
- (26) Kojima T, Kamei H, Aizu T et al. Association analysis between longevity in the Japanese population and polymorphic variants of genes involved in insulin and insulin-like growth factor 1 signaling pathways. *Exp Gerontol* 2004 November;39(11-12):1595-8.
- (27) Kokaze A, Ishikawa M, Matsunaga N et al. Longevity-associated mitochondrial DNA 5178 C/A polymorphism is associated with fasting plasma glucose levels and glucose tolerance in Japanese men. *Mitochondrion* 2005 December;5(6):418-25.

Chapter 4: Familial longevity is marked by enhanced insulin sensitivity

Carolien A. Wijsman^{1,4*}, Maarten P. Rozing^{1,4*}, Trea C.M. Streefland², Saskia le Cessie³, Simon P. Mooijaart^{1,4}, P. Eline Slagboom^{3,4}, Rudi G.J. Westendorp^{1,4}, Hanno Pijl², Diana van Heemst^{1,4}, on behalf of the Leiden Longevity Study group

From the ¹Department of Gerontology and Geriatrics, ²Department of Endocrinology and Metabolic Disease, ³Department of Medical Statistics, Section Molecular Epidemiology, Leiden University Medical Center, PO Box 9600, 2300 RC, Leiden, the Netherlands; ⁴Netherlands Consortium of Healthy Aging (NCHA).

* These authors contributed equally to this work.

Aging Cell. 2011 Feb;10(1):114-21.



Abstract

A key question in aging research is whether the extreme effects of altered insulin signaling on lifespan observed in model organisms can be translated to humans. We aimed to compare the relation between insulin and glucose and tissue specific insulin action between subjects from long-lived families and controls. Non-fasted serum data were analyzed in 1838 subjects and a two step hyperinsulinemic-euglycemic clamp was performed in 24 subjects, comprising offspring from long-lived siblings and their partners. Clamp participants were aged 52-72 years, healthy, non-smoking, non-obese, and groups were similar with regard to sex distribution, age, exercise, BMI, waist circumference, fat mass, and fasting glucose and insulin levels. Higher glucose infusion rate was required to maintain euglycemia during high dose insulin infusion ($p = 0.036$) in offspring from long-lived siblings, reflecting higher whole body insulin sensitivity. After adjustment for sex, age and fat mass, the insulin-mediated glucose disposal rate was higher in offspring than in controls (42.5 ± 2.7 vs. 33.2 ± 2.7 $\mu\text{mol}/\text{kg}\cdot\text{min}$, mean \pm SE, $p=0.025$). The capacity of insulin to suppress endogenous glucose production and lipolysis did not differ between groups (all $p > 0.05$). Furthermore, glucose disposal rate was significantly correlated with the mean age of death of the parents. In conclusion, subjects from long-lived families are marked by enhanced insulin sensitivity and mimic the phenotype found in mammalian models with genetic disruption of IGF-1/insulin signal transduction. These observations allow for identifying biomolecular mechanisms to promote health in old age.

Introduction

A key question in aging research is whether the extreme effects of altered insulin signaling on lifespan observed in model organisms can be translated to humans. The insulin/IGF-1 system, which is highly conserved among (in)vertebrate species, adapts metabolism, growth and differentiation under various environmental conditions, including nutrient availability¹. An ancestral gene encodes just one insulin/IGF-1 receptor tyrosine kinase in invertebrates², while three distinct receptors have evolved in vertebrates to mediate the metabolic and mitogenic effects of insulin, IGF-1 and IGF-2: the insulin receptor, the IGF-1 receptor and the insulin related receptor¹. In addition, the IGF-2 receptor is thought to have evolved primarily as a clearance receptor³. In mammals, the production of IGF-1 is controlled by growth hormone to mediate its effects on growth and development. Extreme effects of IGF and insulin signaling on longevity were shown in invertebrates (reviewed in⁴). In mammals, enhanced insulin sensitivity is prominent in hypopituitary (GH deficient) and GH receptor deleted mice, suggesting that insulin sensitivity is a hallmark phenotype of mammalian longevity, at least in these model organisms⁵.

In humans, insulin sensitivity declines progressively with age, which significantly contributes to the increased incidence of type 2 diabetes mellitus and cardiovascular disease in older people^{6, 7}. A previous study suggested that glucose tolerance and insulin action are preserved in centenarians⁸. We designed the Leiden Longevity Study to examine the underlying biomolecular mechanisms of longevity in humans⁹. To this end we have recruited 421 long-lived families consisting of multiple nonagenarian siblings and their offspring (aged 33-81 years) from the Dutch population. The partners of the offspring (aged 30-80 years) were included as controls. Recently, we showed that the offspring from these families had lower mortality and lower prevalence of major age-related diseases, including diabetes¹⁰. Random and fasting glucose levels were also lower and we showed that glucose tolerance was better in the non-diabetic offspring when compared to controls. Offspring and controls did not differ with respect to age, sex distribution, body mass index, and lifestyle indices such as the level of physical activity¹¹.

To test whether the biomolecular mechanisms underlying familial longevity in humans resemble those of long-lived animal models in terms of insulin action (i.e. whether it is characterized by enhanced insulin sensitivity), here we further explored the relation between insulin and glucose in the two groups. To this end, we first compared the relationship between glucose and insulin levels as determined in random non-fasted serum samples (n=1838), which include the physiological variation in insulin levels in response to everyday challenges, such as meals. Next, we performed a double tracer, 2-step hyperinsulinemic euglycemic clamp in two subgroups comprising 12 healthy offspring from long-lived siblings and 12 partners as control subjects. This gold standard

technique allowed us to assess whole-body insulin sensitivity and distinguish between the effects of insulin on glucose disposal rate, endogenous glucose production and lipolysis.

Materials and methods

Subjects

The Leiden Longevity Study comprises 421 families, as described more extensively elsewhere⁹. Families were recruited if at least two long-lived siblings were alive and fulfilled the age-criterion of 89 years or older for males and 91 year or older for females. As no proper controls exist for this age group, for further studies the offspring of these long-lived nonagenarians were included. This generation carries on average 50% of the genetic advantage of their long-lived parent and was shown to have a 35% lower mortality rate compared with their birth cohort. Their partners, with whom most have had a relationship for decades, were included as population-based controls. Nonfasted serum samples and BMI were available for 1930 subjects. After exclusion of subjects with non-fasted glucose levels above 11 mmol/L (indicative of possible diabetes), history of diabetes or use of glucose lowering medication, non-fasted serum samples of 1838 subjects were available for the current study.

For the hyperinsulinemic euglycemic clamp study, we aimed to include twelve couples, each consisting of an offspring from long-lived siblings and his or her current partner as control subject. Subjects were selected from the database based on the following inclusion criteria: middle-age (50-75 years), residence in close proximity of the research center (less than 45 minutes by car) and normal body mass index (BMI) ($22 \text{ kg/m}^2 < \text{BMI} < 30 \text{ kg/m}^2$). Eligible subjects were screened for the following exclusion criteria: fasting plasma glucose $> 6.9 \text{ mmol/L}$ ¹², presence of endocrine, renal, hepatic or other significant chronic disease, use of medication known to influence lipolysis, glucose metabolism or GH-secretion, recent weight changes or attempts to loose weight ($> \text{three kg weight change within last three months}$), smoking, extensive sporting activities ($> 10 \text{ hours/week}$) and inaccessible peripheral veins for intravenous catheter insertion, as assessed by clinical examination and routine laboratory tests. During the screening interview, information on age (of death) of the parents was obtained.

In total, 87 subjects were approached, of which 17 subjects did not fulfill the inclusion criteria (19%), 44 subjects refused participation (51%) and 26 subjects agreed to participate in the study (30%). Two subjects (one offspring, one control) did not complete the study due to medical technical reasons. One of the partners of an offspring also had a long-lived parent with a long-lived sibling and was therefore included in the offspring group. In total, the group consisted of 24 subjects, comprising 8 couples and 8 unrelated subjects (4 offspring, 4 controls). The Medical

Ethical Committee of the Leiden University Medical Center approved the study and written informed consent was obtained from all subjects.

Clinical protocol.

All clamp studies started at 8:00 AM after an overnight fast. Anthropometric measurements (height, weight, waist and hip circumference) and blood pressure measurements were performed according to standard methods. Body composition was measured using bioelectrical impedance analysis (BIA). In a larger sample of the Leiden Longevity Study, body composition as measured with BIA was highly correlated with dual energy X-ray absorptiometry (DEXA) measurements. (Ling et al, unpublished) Metabolic studies were performed as described previously¹³. Subjects were requested to lie down on a bed in a semirecumbent position. A polyethylene catheter was inserted into an antecubital vein for infusion of test substances. Another catheter was inserted into a contralateral dorsal hand vein for blood sampling; this hand was kept in a heated box (60 °C) throughout the study day to obtain arterialized venous blood samples. Basal samples were taken for measurement of glucose, insulin, total cholesterol, high-density lipoprotein (HDL-) cholesterol, triglycerides, free fatty acids (FFA), glycerol, and background enrichment of [6,6-²H₂]-glucose and [²H₅]-glycerol. At 08:30 AM (t = 0 min), an adjusted primed (17.6 μmol/kg) continuous (0.22 μmol/kg per minute) infusion of [6,6-²H₂]-glucose (enrichment 99.9%; Cambridge Isotopes, Cambridge, Mass) was started and continued throughout the study. At 09:00 AM (t=30 min), a primed (1.6 μmol/kg), continuous (0.11 μmol/kg per minute) infusion of [²H₅]-glycerol (Cambridge Isotopes) was started and continued throughout the study. At the end of the basal period (t = 90 min), three blood samples were taken at 10 min-intervals for the determination of glucose, insulin, glycerol, triglycerides, FFA's and enrichment of [6,6-²H₂]-glucose and [²H₅]-glycerol. Subsequently, a primed continuous infusion of human recombinant insulin (Actrapid, Novo Nordisk Pharma BV, Alphen aan de Rijn, The Netherlands; 10 mU/m² per minute) was started (t = 120 min) for 2 hours. This low dose insulin infusion was used to determine differences in insulin sensitivity of the liver and whole-body lipolysis. Exogenous glucose 20% enriched with 3% [6,6-²H₂]-glucose was infused at a variable rate to maintain the plasma glucose level at 5.0 mmol/L. From t = 210 to t = 240 minutes blood samples were taken at 10 minute intervals for the determination of [6,6-²H₂]-glucose and [²H₅]-glycerol-specific activities, glucose, insulin, glycerol, triglycerides and FFA. Next, at t=240, a primed continuous infusion of insulin was started at 40 mU/m² per minute. This second high dose of insulin infusion was used to determine whole-body glucose disposal. From t = 330 to t = 360 minutes, blood samples were taken at 10 minute intervals for the determination of [6,6-²H₂]-glucose and [²H₅]-glycerol-specific activities, glucose, insulin, glycerol, triglycerides and FFA. Plasma samples

Chapter 4

were put on ice immediately after withdrawal, and all samples were centrifuged at 1610 x g at 4 °C for 20 minutes and stored at -80 °C until assay.

Assays

All serum measurements were performed with fully automated equipment. For glucose, cholesterol, HDL-cholesterol, triglycerides and FFA, the Modular P2 analyzer was used from Roche (Almere, the Netherlands). Insulin was measured using the Immulite 2500 from DPC (Los Angeles, CA, USA). CVs for these measurements were all below 9%.

[6,6-²H₂]-glucose and [²H₅]-glycerol were determined in a single analytical run using gas chromatography-mass spectrometry as described previously¹³. LDL-cholesterol was calculated using the Friedewald formula (11). In case insulin and glycerol values were below threshold for correct estimation of concentration we estimated the concentration to be half of the threshold value.

Calculations

An isotopic steady state was achieved during the steady-state and during the last 30 minutes of the hyperinsulinemic clamp periods. Therefore, steady-state equations were used to calculate tracer infusion rates, according to the modified Steele's steady state equations^{14, 15}. The rates of appearance (Ra) and disappearance (Rd) for glucose and glycerol were calculated by dividing the tracer infusion rate by the tracer-to-tracee ratio. Glucose disposal rates were expressed in μmol/kg body weight per minute. Endogenous glucose production (EGP) during the basal steady state and during the hyperinsulinemic state was calculated as the difference between the rates of glucose appearance and glucose infusion.

Statistical analyses

A piece wise change-point model was used to model the relation between glucose and ln(insulin) for the two groups (n=1838). Within each group, the expected glucose level for a person at a certain level of ln(insulin) were modeled using the formula: predicted glucose = $\alpha_1 + \beta_1 * \ln(\text{insulin})$, for $\ln(\text{insulin}) < \text{gamma}$ and $\alpha_2 + \beta_2 * \ln(\text{insulin})$, for $\text{gamma} < \ln(\text{insulin})$, with restrictions on α_1 and α_2 such that the function is continuous in the transition point gamma, i.e., $(\alpha_1 + \beta_1 * \text{gamma}) = (\alpha_2 + \beta_2 * \text{gamma})$. Because transition points were similar between groups, group differences in slopes before (difbeta1) and after (difbeta2) the transition point (gamma) were modeled using the formula: predicted glucose = $\text{ALPHA} + \text{difalpha} * \text{partner} + (\text{BETA1} + \text{difbeta1} * \text{partner}) * (\ln(\text{Insuline-gamma}) * ((\ln(\text{Insuline-gamma}) < 0) + (\text{BETA2} + \text{difbeta2} * \text{partner}) * (\ln(\text{Insuline-gamma}) * ((\ln(\text{Insuline-gamma}) > 0))$. The model was fitted using software for nonlinear regression models. Data are presented as mean with standard

deviation (baseline characteristics) or mean with standard error (SE) to assess differences between groups. Differences in outcomes between groups as well as the associations of glucose disposal rate (GDR) with age of parents were calculated using a linear regression model with correction for age, sex and fat mass. Statistical significance was set a $p < 0.05$. All analyses were performed using SPSS version 17.0.

Results

The relationship between non-fasted glucose and insulin in the baseline cohort.

Table 1. Baseline characteristics of baseline cohort

	Offspring (n=1273)	Controls (n=565)
Female gender, n (%)	692 (54.4)	329 (58.2)
Age (yr)	59.4 (6.4)	58.7 (7.4)
BMI (kg/m ²)	25.3 (3.4)	25.5 (3.6)
Glucose (mmol/L)	5.7 (1.1)	5.9 (1.2)
Ln Insulin (mU/L)	2.7 (0.8)	2.8 (0.8)

Continuous data are presented as means with S.D

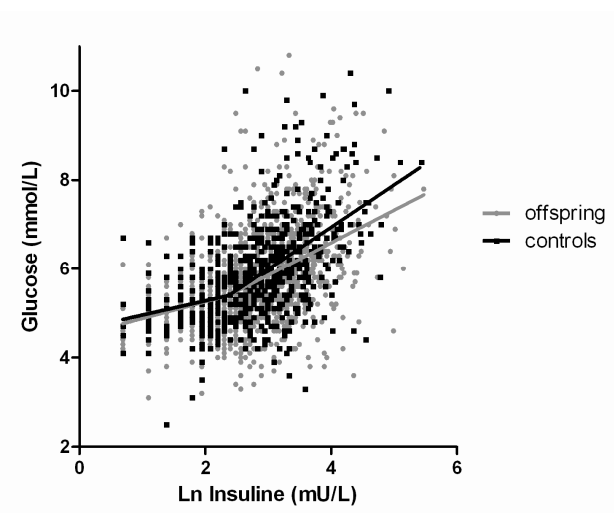

Figure 1. Relation between non-fasted insulin and glucose values in baseline cohort of the Leiden Longevity Study (n=1838).

Table 1 shows the baseline characteristic of the baseline cohort (n=1838). Baseline characteristics were similar between the offspring and controls. **Figure 1** shows the non-fasted serum insulin versus glucose levels for the two groups. For both groups, a biphasic positive association was observed between levels of glucose and ln(insulin). Initially slopes were similar between groups (0.38 in offspring vs. 0.32 in partners, p=0.73); diverged from ln(insulin)= 2.37 (corresponding to 10.7 mU/L insulin) onwards, after which slopes were significantly steeper in the partners (0.73 in offspring vs. 0.95 in partners, p=0.02).

Baseline characteristics of the hyperinsulinemic-euglycemic clamp study.

Next, we performed a hyperinsulinemic euglycemic clamp in 24 subjects. **Table 2** shows the baseline characteristics of the study groups. The group of offspring from long-lived siblings did not differ from the control group with respect to any of the baseline characteristics, although the offspring group showed a tendency towards a slightly higher age and fat mass.

Table 2. Baseline characteristics of clamp group

	Offspring (n=12)	Controls (n=12)
Female gender (%)	50.0	50.0
Age (yr)	62.7 (2.4)	61.2 (5.5)
Systolic blood pressure (mmHg)	142.5 (20.6)	143.2 (25.0)
Diastolic blood pressure (mmHg)	86.8 (10.7)	86.2 (11.1)
Weight (kg)	79.3 (10.3)	80.1 (9.7)
BMI (kg/m ²)	26.0 (2.0)	26.1 (2.3)
Fat mass (%)	33.0 (7.3)	30.9 (9.7)
Lean mass (kg)	53.6 (11.5)	53.8 (12.2)
Waist circumference (cm)	93.0 (10.8)	93.6 (7.7)
Waist/Hip ratio	0.90 (0.1)	0.89 (0.1)
Total cholesterol (mmol/L)	6.1 (1.0)	5.9 (0.8)
HDL-cholesterol (mmol/L)	1.7 (0.4)	1.7 (0.4)
LDL-cholesterol (mmol/L)	3.9 (0.9)	3.8 (0.7)
Mean age parents (yr)	88.3 (4.0)	76.6 (8.2)
Age oldest parent (yr)	97.0 (3.8)	82.3 (10.5)

Continuous data are presented as means with S.D

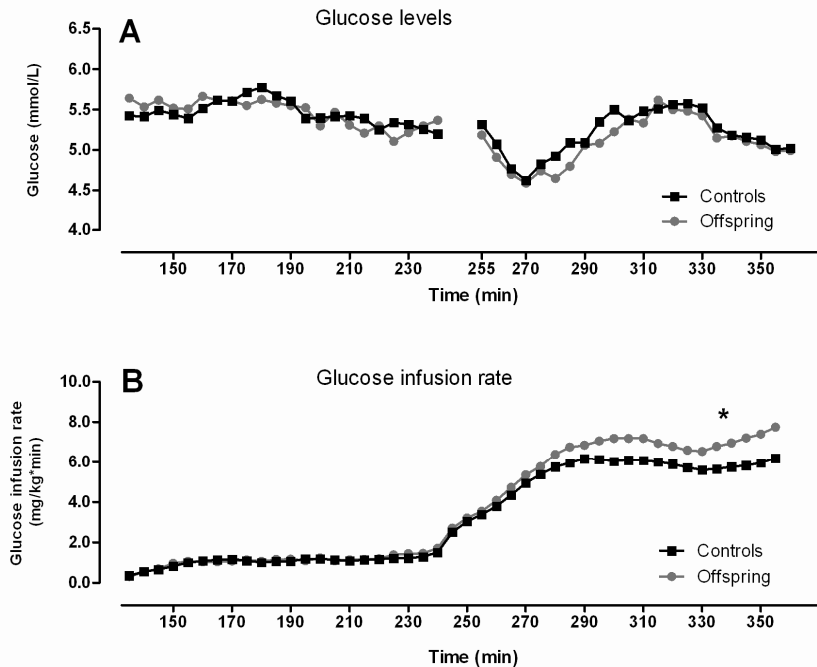

Figure 2. A. Glucose levels and B. glucose infusion rates during the clamp study.

* $p < 0.05$ for the difference in M -value (whole-body-glucose metabolism) between groups during the last 30 minutes of high dose insulin infusion (corrected for sex, age and fat mass (%))

Familial longevity associates with higher whole-body glucose metabolism

A two-step hyperinsulinemic clamp was performed using a low ($10 \text{ mU/m}^2/\text{min}$) and a high ($40 \text{ mU/m}^2/\text{min}$) insulin dose in the first and second clamp step, respectively. Mean insulin levels during the last 30 minutes of the clamp periods were similar between groups, both during low dose insulin infusion ($11.0 \pm 1.0 \text{ mU/L}$ in offspring vs. $11.2 \pm 1.0 \text{ mU/L}$ in controls, $p = 0.89$) and during high dose insulin infusion ($42.5 \pm 2.2 \text{ mU/L}$ in offspring vs $38.9 \pm 2.2 \text{ mU/L}$ in controls $p = 0.25$). Throughout the entire clamp glucose levels remained stable and were similar between groups (**figure 2a**). **Figure 2b** shows the glucose infusion rates during the clamp. During high dose insulin infusion, offspring had significantly higher glucose infusion rates ($p = 0.036$) compared to controls, despite a slightly higher age and fat mass in the offspring.

Familial longevity is characterized by enhanced peripheral insulin sensitivity, but not hepatic insulin sensitivity

Next, we assessed whether the higher glucose infusion rate required to maintain euglycemia in offspring was accounted for by increased glucose disposal or by enhanced insulin-mediated suppression of endogenous glucose production (**table 3, figure 3**). At low dose insulin infusion

Chapter 4

(10 mU/m²/min), the groups did not differ with respect to endogenous glucose production. At high dose insulin infusion (40 mU/m²/min), the mean glucose disposal rate was higher in offspring than in controls (42.5 ± 2.7 vs. 33.2 ± 2.7 $\mu\text{mol/kg/min}$, $p=0.025$). To determine the insulin sensitivity of adipose tissue, we assessed the capacity of insulin to suppress the rate of glycerol appearance (Ra). At baseline and during both clamp conditions, the Ra of glycerol was similar in offspring and controls (**table 3, figure 3**), (all $p > 0.05$).

Table 3. Glucose and fat metabolism in offspring enriched for longevity and controls under different clamp conditions

	Basal steady state			Insulin (10mU/m ² /min)			Insulin (40 mU/m ² /min)		
	Offspring	Controls	p-value	Offspring	Controls	p-value	Offspring	Controls	p-value
Plasma Glucose (mmol/L)	6.1 (0.1)	5.9 (0.1)	0.27	5.6 (0.1)	5.6 (0.1)	0.69	5.5 (0.1)	5.4 (0.1)	0.64
Plasma Insulin (mU/L)	5.4 (1.1)	4.7 (1.1)	0.68	10.8 (1.1)	11.5 (1.1)	0.66	41.9 (2.2)	39.5 (2.2)	0.45
Glucose Rd (μmol/kg/min)	12.9 (0.3)	12.6 (0.3)	0.43	15.5 (1.0)	14.3 (1.0)	0.57	42.5 (2.7)	33.2 (2.7)	0.025
Clamp EGP (μmol/kg/min)	12.7 (0.3)	12.4 (0.3)	0.57	7.8 (0.3)	7.9 (0.3)	0.85	1.8 (0.3)	2.1 (0.3)	0.36
Glycerol Ra (μmol/kg/min)	2.1 (0.2)	2.4 (0.2)	0.34	0.9 (0.1)	1.0 (0.1)	0.36	0.6 (0.1)	0.7 (0.1)	0.52
FFA (mmol/L)	0.60 (0.1)	0.76 (0.1)	0.07	0.14 (0.03)	0.21 (0.03)	0.08	<0.05 (0.005)	<0.05 (0.005)	0.94
Triglycerides (mmol/L)	1.17 (0.2)	1.0 (0.2)	0.49	1.0 (0.2)	0.9 (1.2)	0.52	0.91 (0.2)	0.74 (0.2)	0.49

Glucose Rd = Rate of disappearance of glucose EGP = Endogenous Glucose Production Glycerol Ra = Rate of appearance of glycerol FFA = free fatty acids

During basal steady state, glucose Rd is composed of endogenous glucose production and tracer infusion.

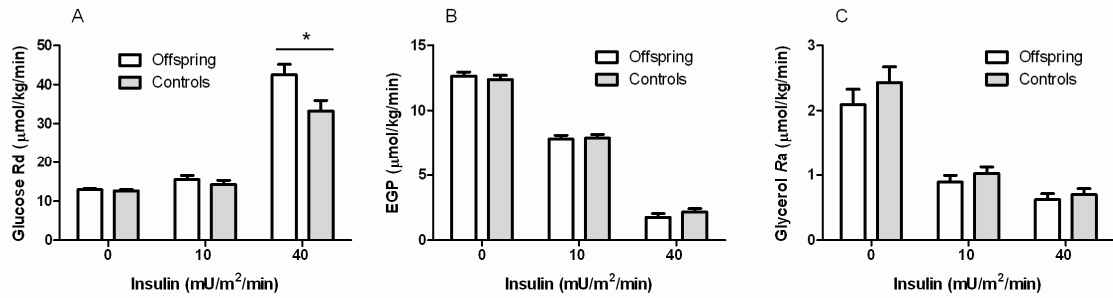

Figure 3. Glucose and fat metabolism in offspring and controls under different clamp conditions; **A.** glucose disposal rate (**Rd**), **B.** endogenous glucose production (**EGP**), **C.** rate of appearance of glycerol (**Ra**). Results are means with standard error, after adjustment for age, sex and fat mass (%).

Insulin sensitivity correlates positively with the age at death of the subjects' parents

The presented results suggest a relation between familial longevity and glucose disposal rate. To explore if this association was specific for offspring of long-lived siblings only or of a more general nature, we assessed the relationship between parental age (at death or censorship) with the glucose disposal rate under high dose insulin infusion in all subjects (**figure 4, table 4**).

After adjustment for sex, age and fat mass, we found a positive correlation between the mean age of the parents and glucose disposal rate ($p = 0.007$), and between the age of the oldest parent and the glucose disposal rate ($p = 0.034$). To exclude the possibility that these results were driven by the high age of parental death in the offspring group, we repeated the analyses for the control group only, and results did not change materially (**table 4**). Also, excluding subjects with parents who were still alive at date of censorship did not change results (data not shown).

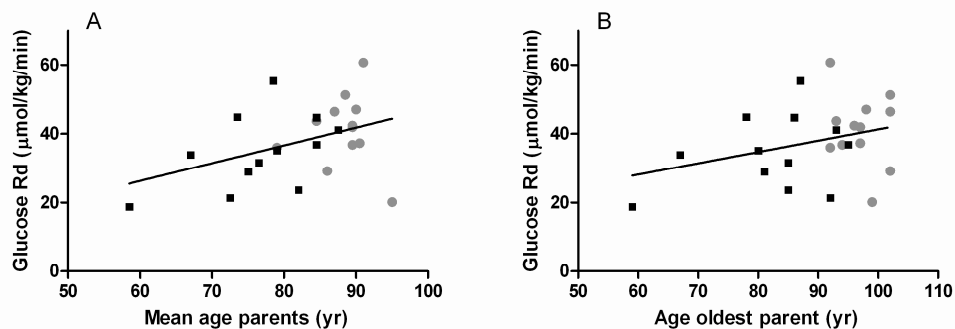

Figure 4. **A** Relation between mean age of both parents (at death or censorship) and glucose disposal rate; **B.** Relation between age of oldest parent only (at death or censorship) and glucose disposal rate. Grey circles represent the offspring, black squares represent controls.

Table 4. Relation between parental age and glucose disposal rate

	all subjects (n=24)			controls only (n=12)		
	β	S.E.	p-value	β	S.E.	p-value
1. mean age of both parents						
Crude	0.52	0.2	0.045	0.65	0.4	0.11
Multivariate	0.65	0.2	0.007	0.69	0.2	0.022
2. age of oldest parent only						
Crude	0.33	0.2	0.12	0.33	0.3	0.30
Multivariate	0.43	0.2	0.034	0.37	0.3	0.19

β represents increase in glucose disposal rate ($\mu\text{mol/kg/min}$) per year increase in age of death of the parent(s).

S.E. = standard error. When parents were still alive, current age was used.

Multivariate: adjusted for age, sex and fat mass. p-value obtained using linear regression analysis.

Discussion

Here, we show that familial longevity in humans is characterized by enhanced peripheral insulin sensitivity, i.e. compared to a control group with similar distribution of age, sex and body composition, healthy offspring of long-lived siblings had a higher insulin-mediated glucose disposal rate. In contrast, the capacity of insulin to suppress endogenous glucose production or lipolysis did not differ between the groups. Interestingly, the glucose disposal rate during hyperinsulinemia was positively correlated with the age at death of the parents of the entire group, suggesting that longevity genes are involved in the control of insulin action in the general population.

This is the first study to show that subjects genetically predisposed for healthy longevity have higher whole-body insulin sensitivity when compared to a control group similar in age, sex and body composition and lifestyle indices such as smoking, socio-economic status and physical activity. A previous study showed preserved whole-body insulin sensitivity in healthy centenarians, but different to our study, these data could not be compared to a control group of similar age and body mass index⁸. Moreover, here we document that it is insulin action on glucose metabolism, and glucose disposal in particular, that distinguishes offspring of long-lived siblings from controls. Insulin action on lipolysis did not differ between the groups. These data

suggest that glucose metabolism is involved in the control of aging in humans, as has recently been demonstrated for *Caenorhabditis elegans*¹⁶.

The importance of preservation of insulin action on glucose disposal is in line with previous studies on the pathophysiology of type 2 diabetes mellitus. Muscle insulin resistance is being regarded as one of the earliest steps in the pathophysiology of diabetes mellitus^{17, 18}, and can be found already several decades before onset of the disease^{19, 20}. Insufficient suppression of hepatic glucose production, on the other hand, is seen as a consequence of fat accumulation in the liver²¹, and is regarded a later phenomenon in the trajectory towards onset of diabetes¹⁸. Virtually all of this is mediated by increased fat mass, overweight and reduced physical exercise explaining for the epidemic of diabetes associated with increased disabilities and decreased life expectancy. It should be emphasized that the phenomena that we describe here are independent of fat mass and exercise and are likely to reflect a different and evolutionary conserved biomolecular mechanism of longevity.

Several possible explanations exist for the link between preserved insulin sensitivity and familial longevity. Insulin resistance and compensatory hyperinsulinemia are risk factors for a variety of (age related) diseases, including obesity, type 2 diabetes²² and cardiovascular disease²³. Furthermore, insulin resistance shows familial clustering^{24, 25} and is more prominent in non-diabetic offspring of patients with diabetes type 2²⁶. Thus, the present data are in keeping with our previous observation of a reduced prevalence of type 2 diabetes and myocardial infarction among offspring of long-lived siblings comprising the entire Leiden Longevity Study cohort (4). Less age related morbidity and associated mortality could readily explain why the offspring of long-lived siblings have a propensity to live longer⁹.

Alternatively or in addition, in middle-aged individuals, insulin sensitivity may be a hallmark of a different physiological state associated with increased life expectancy. Interestingly, enhanced insulin sensitivity in the offspring of long-lived siblings co-occurs with other phenotypic features, including lower levels of active thyroid hormone²⁷, a different spectrum of cellular responses to oxidative stress *in vitro*²⁸ and larger LDL particle sizes²⁹. The co-occurrence of multiple beneficial features is reminiscent of the phenotype seen in genetically modified long-lived mammals as well as in calorie-restricted mammals³⁰. In long-lived mammalian models, including hypopituitary (GH deficient) dwarf- and GH receptor knock out mice, enhanced insulin sensitivity often co-occurs with enhanced protection against oxidative damage^{31, 32}. Conversely, it has recently been shown that mitochondrial superoxide production is a common feature of many different *in vitro* and *in vivo* models of insulin resistance³³. Pathways implicated in mediating longevity phenotypes in genetically modified long-lived mammals as well as in

calorie-restricted mammals include modulation of FOXO, AMPK, Sirtuins and mTOR³⁴. Interestingly, genetic variants of FOXO3A have been linked to human longevity in seven different cohorts, including Hawaiians of Japanese descent, Italians, Ashkenazi Jews, Californians, New Englanders, Germans and Chinese (reviewed in⁴). Given the complexity of pathways and the generally small but possibly additive effects observed for individual genetic variants³⁵, stronger effects will possibly be observed when entire genetic pathways will be analysed³⁶.

The strict selection criteria for the clamp study participants may have diminished the experimental contrast between the groups and masked even greater differences in insulin action. The groups were comparable for age, gender, environmental conditions and lifestyle indices, and type 2 diabetes and/or any other chronic disease were reasons to exclude individuals from participation (whether it concerned offspring or control). Since the prevalence of age-related pathology, including diabetes and cardiovascular disease associated with insulin resistance, is higher in controls¹⁰, inclusion of all cohort members (irrespective of the presence of chronic disease) would probably have revealed an even more explicit difference in insulin action between offspring and controls but would have hampered causal inference.

The insulin levels during the hyperinsulinemic clamp study were comparable to insulin levels in the non-fasted, randomly obtained serum samples in the larger baseline cohort of the Leiden Longevity Study. Likewise, the different response to insulin in offspring under experimental high insulin clamp conditions was reflected by a comparable difference in the relationship between randomly taken non-fasted insulin and glucose levels in the higher range of insulin levels. This suggests that the differences in insulin sensitivity found between offspring and controls under controlled, experimental conditions may reflect everyday physiological conditions.

In conclusion, familial longevity in humans is marked by an increased capacity of insulin to stimulate glucose disposal, which confirms observations in mammalian models of longevity. Moreover, the age at death of the parents predicts the glucose disposal rate in response to insulin infusion in their offspring, suggesting that longevity genes are involved in the control of insulin action in man. Taken together, our data suggest that genetic predisposition for longevity is associated with altered insulin sensitivity in man as it is in model organisms. Our future research will focus on identifying the underlying biomolecular mechanisms and pathways.

Acknowledgements

The study was supported by the Innovation Oriented research Program on Genomics (SenterNovem; IGE01014 and IGE5007), the Centre for Medical Systems Biology (CMSB), the Netherlands Genomics Initiative/Netherlands Organization for scientific research (NGI/NWO; 05040202 and 050-060-810) and the EU funded Network of Excellence Lifespan (FP6 036894). The authors have no conflict of interest. We would like to thank all participants, E.J.M. Ladan-Eygenraam, M. H. van der Star, E. H. Bemer-Oorschot A. Aziz, M. Snel, E. Donga, M. van Dijk, G. Labots, M. Peters and P. Buijzerd-Amesz for their participation, technical support and assistance during the clamp studies.

Reference List

- (1) Belfiore A, Frasca F, Pandini G, Sciacca L, Vigneri R. Insulin receptor isoforms and insulin receptor/insulin-like growth factor receptor hybrids in physiology and disease. *Endocr Rev* 2009 October;30(6):586-623.
- (2) Ruvkun G, Hobert O. The taxonomy of developmental control in *Caenorhabditis elegans*. *Science* 1998 December 11;282(5396):2033-41.
- (3) Kornfeld S. Structure and function of the mannose 6-phosphate/insulinlike growth factor II receptors. *Annu Rev Biochem* 1992;61:307-30.
- (4) Kenyon CJ. The genetics of ageing. *Nature* 2010 March 25;464(7288):504-12.
- (5) Bartke A. Insulin and aging. *Cell Cycle* 2008 November 1;7(21):3338-43.
- (6) Chen M, Bergman RN, Pacini G, Porte D, Jr. Pathogenesis of age-related glucose intolerance in man: insulin resistance and decreased beta-cell function. *J Clin Endocrinol Metab* 1985 January;60(1):13-20.
- (7) Davidson MB. The effect of aging on carbohydrate metabolism: a review of the English literature and a practical approach to the diagnosis of diabetes mellitus in the elderly. *Metabolism* 1979 June;28(6):688-705.
- (8) Paolisso G, Gambardella A, Ammendola S et al. Glucose tolerance and insulin action in healthy centenarians. *Am J Physiol* 1996 May;270(5 Pt 1):E890-E894.
- (9) Schoenmaker M, de Craen AJ, de Meijer PH et al. Evidence of genetic enrichment for exceptional survival using a family approach: the Leiden Longevity Study. *Eur J Hum Genet* 2006 January;14(1):79-84.
- (10) Westendorp RG, van Heemst D, Rozing MP et al. Nonagenarian siblings and their offspring display lower risk of mortality and morbidity than sporadic nonagenarians: The Leiden Longevity Study. *J Am Geriatr Soc* 2009 September;57(9):1634-7.
- (11) Rozing MP, Westendorp RG, de Craen AJ et al. Favorable glucose tolerance and lower prevalence of metabolic syndrome in offspring without diabetes mellitus of nonagenarian siblings: the Leiden longevity study. *J Am Geriatr Soc* 2010 March;58(3):564-9.

Chapter 4

- (12) American Diabetes Association. Diagnosis and classification of diabetes mellitus. *Diabetes Care* 28[Suppl. 1], S37-S42. 2005.
- (13) Jazet IM, Pijl H, Frolich M, Romijn JA, Meinders AE. Two days of a very low calorie diet reduces endogenous glucose production in obese type 2 diabetic patients despite the withdrawal of blood glucose-lowering therapies including insulin. *Metabolism* 2005 June;54(6):705-12.
- (14) Finegood DT, Bergman RN, Vranic M. Estimation of endogenous glucose production during hyperinsulinemic-euglycemic glucose clamps. Comparison of unlabeled and labeled exogenous glucose infusates. *Diabetes* 1987 August;36(8):914-24.
- (15) Steele R. Influences of glucose loading and of injected insulin on hepatic glucose output. *Ann N Y Acad Sci* 1959 September 25;82:420-30.
- (16) Lee SJ, Murphy CT, Kenyon C. Glucose shortens the life span of *C. elegans* by downregulating DAF-16/FOXO activity and aquaporin gene expression. *Cell Metab* 2009 November;10(5):379-91.
- (17) DeFronzo RA, Bonadonna RC, Ferrannini E. Pathogenesis of NIDDM. A balanced overview. *Diabetes Care* 1992 March;15(3):318-68.
- (18) Taylor R. Pathogenesis of type 2 diabetes: tracing the reverse route from cure to cause. *Diabetologia* 2008 October;51(10):1781-9.
- (19) Lillioja S, Mott DM, Howard BV et al. Impaired glucose tolerance as a disorder of insulin action. Longitudinal and cross-sectional studies in Pima Indians. *N Engl J Med* 1988 May 12;318(19):1217-25.
- (20) Lillioja S, Mott DM, Spraul M et al. Insulin resistance and insulin secretory dysfunction as precursors of non-insulin-dependent diabetes mellitus. Prospective studies of Pima Indians. *N Engl J Med* 1993 December 30;329(27):1988-92.
- (21) Seppala-Lindroos A, Vehkavaara S, Hakkinen AM et al. Fat accumulation in the liver is associated with defects in insulin suppression of glucose production and serum free fatty acids independent of obesity in normal men. *J Clin Endocrinol Metab* 2002 July;87(7):3023-8.

- (22) Stumvoll M, Goldstein BJ, van Haefen TW. Type 2 diabetes: pathogenesis and treatment. *Lancet* 2008 June 28;371(9631):2153-6.
- (23) Sjöholm A, Nystrom T. Endothelial inflammation in insulin resistance. *Lancet* 2005 February 12;365(9459):610-2.
- (24) Lillioja S, Mott DM, Zawadzki JK et al. In vivo insulin action is familial characteristic in nondiabetic Pima Indians. *Diabetes* 1987 November;36(11):1329-35.
- (25) Martin BC, Warram JH, Rosner B, Rich SS, Soeldner JS, Krolewski AS. Familial clustering of insulin sensitivity. *Diabetes* 1992 July;41(7):850-4.
- (26) Haffner SM, Stern MP, Hazuda HP, Mitchell BD, Patterson JK. Increased insulin concentrations in nondiabetic offspring of diabetic parents. *N Engl J Med* 1988 November 17;319(20):1297-301.
- (27) Rozing MP, Westendorp RG, de Craen AJ et al. Low Serum Free Triiodothyronine Levels Mark Familial Longevity: The Leiden Longevity Study. *J Gerontol A Biol Sci Med Sci* 2010 April; 65(4):365-8.
- (28) Dekker P, Maier AB, van Heemst D et al. Stress-induced responses of human skin fibroblasts in vitro reflect human longevity. *Aging Cell* 2009 September;8(5):595-603.
- (29) Heijmans BT, Beekman M, Houwing-Duistermaat JJ et al. Lipoprotein particle profiles mark familial and sporadic human longevity. *PLoS Med* 2006 December;3(12):e495.
- (30) Colman RJ, Anderson RM, Johnson SC et al. Caloric restriction delays disease onset and mortality in rhesus monkeys. *Science* 2009 July 10;325(5937):201-4.
- (31) Bokov AF, Lindsey ML, Khodr C, Sabia MR, Richardson A. Long-lived ames dwarf mice are resistant to chemical stressors. *J Gerontol A Biol Sci Med Sci* 2009 August;64(8):819-27.
- (32) Brown-Borg HM, Rakoczy SG. Glutathione metabolism in long-living Ames dwarf mice. *Exp Gerontol* 2005 January;40(1-2):115-20.
- (33) Hoehn KL, Salmon AB, Hohnen-Behrens C et al. Insulin resistance is a cellular antioxidant defense mechanism. *Proc Natl Acad Sci U S A* 2009 October 20;106(42):17787-92.

Chapter 4

- (34) Guarente L. Mitochondria--a nexus for aging, calorie restriction, and sirtuins? *Cell* 2008 January 25;132(2):171-6.
- (35) Kuningas M, Mooijaart SP, van Heemst D, Zwaan BJ, Slagboom PE, Westendorp RG. Genes encoding longevity: from model organisms to humans. *Aging Cell* 2008 March;7(2):270-80.
- (36) Pawlikowska L, Hu D, Huntsman S et al. Association of common genetic variation in the insulin/IGF1 signaling pathway with human longevity. *Aging Cell* 2009 August;8(4):460-72.

Chapter 5: C-reactive protein and glucose regulation in familial longevity

Maarten P. Rozing^{1,4} Simon P. Mooijaart^{1,4}, Marian Beekman^{2,4}, Carolien A. Wijzman^{1,4}, Andrea B. Maier^{1,4}, A. Bartke³, Rudi G.J. Westendorp^{1,4}, P. Eline Slagboom^{2,4}, Diana van Heemst^{1,4}, on behalf of the Leiden Longevity Study (LLS) Group

From the ¹Department of Gerontology and Geriatrics, Leiden University Medical Center, P.O. Box 9600, 2300 RC, Leiden, the Netherlands; ²Department of Molecular Epidemiology, Leiden University Medical Center, P.O. Box 9600, 2300 RC Leiden, The Netherlands, ³Department of Internal Medicine, Southern Illinois University School of Medicine, P.O. Box 19636, 62794-9628, Springfield, Illinois, United States of America, ⁴Netherlands Consortium of Healthy Aging (NCHA).

Age (Dordr). 2011 Jan 19 *Age Epub ahead of print*



Abstract

Earlier we showed that the offspring from exceptionally long-lived families have a more favorable glucose metabolism when compared to controls. As chronic low-grade inflammation has been regarded as a strong risk factor for insulin resistance, we evaluated if and to what extent the favorable glucose metabolism in offspring from long-lived families could be explained by differences in subclinical inflammation, as estimated from circulating levels of C-reactive protein. We found no difference between the two groups in C-reactive protein levels or in the distribution of C-reactive protein haplotypes. However, among controls higher levels of C-reactive protein were related to higher glucose levels, whereas among offspring levels of C-reactive protein were unrelated to glucose levels. The current study suggests that the favorable glucose metabolism in offspring from long-lived families allows tight regulation of glucose levels despite elevated markers of low-grade inflammation. This finding indicates a robust insulin sensitivity which may render subjects from long-lived families resilient against the effects of low-grade inflammation and concomitant morbidity.

Introduction

The association between chronic subclinical inflammation and insulin resistance has been well established ¹. Insulin resistance in turn is regarded a strong risk factor for type 2 diabetes, hypertension and cardiovascular disease ^{2;3}. Levels of C-reactive protein (CRP), a marker of systemic inflammation, are elevated in subjects with impaired glucose tolerance as well as in overt diabetes ^{4;5} and increased levels of CRP are predictive for development of diabetes ^{6;7}. Observational studies have shown a relation between elevated levels of CRP and elevated glucose levels in subjects without diabetes as well ⁸⁻¹⁰.

In the Leiden Longevity Study we have recruited exceptionally long-lived families based on proband siblings that both exhibit exceptional longevity. We also included the middle-aged offspring of the long-lived siblings and their partners as population based controls. Earlier we have shown that the offspring from these long-lived families have a lower prevalence of type 2 diabetes when compared to controls ¹¹. Moreover, we demonstrated that after exclusion of diabetic patients the offspring from long-lived families had relatively lower fasted and non-fasted glucose levels as well as a higher glucose tolerance ^{12;13}. The differences in glucose metabolism between offspring from long-lived families and controls could not be explained by differences in body composition or life style, such as smoking or physical activity.

In the current study, we sought to evaluate whether and to what extent the observed differences in glucose metabolism between the offspring from long-lived families and controls can be explained by differences in subclinical inflammation, as estimated from circulating levels of CRP. Therefore we examined high-sensitivity C-reactive protein (hsCRP) serum levels as well as CRP genotypes and their influence on glucose regulation in the offspring from exceptionally long-lived families and controls.

Materials and methods

The Leiden Longevity Study

The recruitment of 421 families in the Leiden Longevity Study has been described before.¹⁴ A short outline is provided here. Families were recruited if at least two long lived siblings were alive and fulfilled the age-criterion of 89 years or older for males and 91 year or older for females. There were no selection criteria on health or demographic characteristics. For 2415 offspring of long-lived siblings and their partners as population controls, non-fasting serum samples were taken at baseline for the determination of endocrine and metabolic parameters. Additional information was collected from the generation of offspring and controls, including self-reported information on life style, information on medical history from the participants'

Chapter 5

treating physicians and information on medication use from the participants' pharmacists. Subjects with hsCRP levels higher than 10.0 mg/L were excluded from the study (68 offspring (4.6%) and 31 controls (4.9%)) as were subjects with diabetes (65 offspring (4.4%) and 53 controls (8.3%)). Subjects were regarded as having diabetes if they had non-fasted glucose levels >11.0 mmol/L, a previous medical history of diabetes and/or used glucose lowering agents. In 84 subjects (61 offspring and 23 controls) data on hsCRP and/or glucose were not available.

CRP genotypes

Three single nucleotide polymorphisms (SNPs) were selected that associate with serum CRP levels: rs1205 (positioned in 3'UTR, alleles C/T), Rs1800947 (positioned in Codon 184, alleles G/C) and Rs1417938 (positioned in intron 1, alleles T/A). Genotyping of the SNPs was performed using Sequenom MassARRAY iPLEX® Gold. The high iPLEX primer design was performed by entering the sequences encompassing each polymorphism into SpectroDESIGNER provided by Sequenom®, Inc. (CA, USA). The high plex reaction protocol was used (www.sequenom.com/iplx). The average genotype call rate for genotyped SNPs was 96.3% and the average concordance rate was 99.7% among 4% duplicated control samples. All SNPs were in Hardy-Weinberg equilibrium ($P \geq 0.05$)

Plasma parameters

All serum measurements were performed with fully automated equipment. For insulin the Immulite 2500 from DPC (Los Angeles, CA, USA) was applied. For insulin the coefficient of variation was below 8%. For glucose and CRP, the Hitachi Modular P 800 from Roche, Almere, the Netherlands was applied. CV's of these measurements were below 5 %.

Statistical analysis

The program haploview was used to estimate allele frequencies, test the consistency of genotype frequencies at each SNP locus with Hardy-Weinberg equilibrium and estimate and plot pair wise LD between the examined SNPs. Haplotypes and haplotype frequencies were estimated using the SNPHAP software. The posterior probabilities of haplotypes <95% were excluded from the analyses (61 offspring and 24 controls).

Distributions of continuous variables were examined for normality and serum insulin levels and hsCRP levels were logarithmically transformed prior to analyses. Differences in age between the groups of offspring and controls were tested using a Mann-Whitney rank sum test. Differences in sex distribution between the groups of offspring and controls were calculated using a Chi-square test. Geometric means (with 95% confidence intervals (CI)) are reported for transformed

variables. Associations between serum levels as well as associations between *CRP* haplotypes and serum levels were tested using a linear mixed model with a random sibship effect to model correlation of sibling data. Age, sex, body mass index and use of lipid lowering agents were regarded as potential confounders in this association and were included in the analyses. The Statistical Package for the Social Sciences (SPSS) program for Windows, version 16.0 was used for data analysis.

Results

The principal features of the study groups, both without diabetes, are displayed in **table 1**. The proportion of males was slightly higher in the group of offspring than in the group of controls. Body mass index was similar between the two groups ($P=0.57$). Non-fasted glucose levels were lower in the group of offspring when compared to the group of controls ($P=0.001$), while non-fasted insulin levels did not differ ($P=0.16$). We did not observe a difference in serum levels of high sensitivity C-reactive protein (hsCRP) between the two groups. Also after adjustment for the potential confounders age, sex, body mass index and the use of lipid lowering agents, no difference in hsCRP levels was observed between the two groups (**table1**)

Potentially, genetic variation could mask true differences in CRP levels between the two groups. To distinguish between constitutional and acquired levels of hsCRP, we performed a genetic analysis of haplotypes constructed from the common *CRP* variants rs1205, rs1800947 and rs1417938, that have previously been associated with serum CRP levels. For the present analyses we report the results of the four most common haplotypes (frequency>5%) that cumulatively account for 99.9% of the haplotypes. The relation between the four selected haplotypes and serum hsCRP levels is depicted in **table 2**. All haplotypes correlated significantly with hsCRP levels. An increasing number of haplotype 1 and 2 gave rise to higher hsCRP levels, whereas an increasing number of haplotype 3 and 4 was related to a decrease in hsCRP serum levels. The change in hsCRP levels over the number of haplotypes was not different between offspring and controls.

Table 1. Baseline characteristics of the study population

	Offspring	Controls	p-value
Participants (N)	1479	635	
Male sex (N, %)	691 (46.7)	264 (41.6)	0.032
Age in year (median (interquartile range))	59.1 (54.9 – 64.0)	58.7 (53.8 – 63.6)	0.078
Body Mass Index in kg/m ² (mean 95% CI)*	25.3 (25.0 – 25.5)	25.4 (25.1 – 25.7)	0.57
Lipid-lowering agent (N, %)	87 (5.9)	45 (7.1)	0.33
Currently smoking [§]	167 (13.2)	78 (14.0)	0.66
Insulin in μ IU/L (mean 95% CI)	15.7 (14.9 – 16.4)	16.6 (15.5 – 17.7)	0.16
Glucose in mmol/L (mean 95% CI)	5.70 (5.64 – 5.77)	5.90 (5.81 – 5.99)	0.001
HsCRP in mg/dL (mean 95% CI)			
Adjusted for sex and age (model 1)	1.21 (1.15 – 1.28)	1.25 (1.16 – 1.34)	0.54
Model 1 and body mass index	1.20 (1.32 – 1.26)	1.23 (1.15 – 1.32)	0.56
Model 1 and lipid lowering agents	1.06 (0.97 – 1.16)	1.10 (1.00 – 1.21)	0.48
Model 1 and current smoking status [†]	1.30 (1.21 – 1.40)	1.34 (1.23 – 1.46)	0.53
Model 1 and body mass index and lipid lowering agents and current smoking status	1.11 (1.01 – 1.23)	1.14 (1.03 – 1.26)	0.54

Results for insulin and hsC-reactive protein (hsCRP) are presented as estimated geometric means with 95% confidence intervals. *Data on body mass was available for 1823 subjects (1266 offspring and 557 partners). Results for body mass index were adjusted for age and sex. [†]Data on [§]current smoking status were available for 1819 subjects (1262 offspring and 557 partners). Results for insulin and glucose were adjusted for age, sex and body mass index. 95% CI: 95% confidence interval.

Next we assessed if the distribution of *CRP* haplotypes was different between the two groups. In both the study groups haplotypes were in Hardy-Weinberg equilibrium. No difference in the frequencies of *CRP* haplotypes was observed between the group of offspring and the group of controls. (**table 3**)

Table 2. Association between CRP haplotypes and serum hsCRP levels

Haplotype	0-copies (mean (95% CI))	1-copy (mean (95% CI))	2-copies (mean (95% CI))	P for trend	P interaction
HsCRP (mg/dL)					
1	1.17 (1.09 – 1.24)	1.25 (1.18 – 1.34)	1.35 (1.20 – 1.51)	0.015	0.87
2	1.13 (1.06 – 1.20)	1.28 (1.20 – 1.36)	1.45 (1.28 – 1.65)	<0.001	0.63
3	1.32 (1.24 – 1.40)	1.14 (1.07 – 1.22)	1.04 (0.89 – 1.22)	<0.001	0.18
4	1.27 (1.21 – 1.34)	0.97 (0.87 – 1.09)	0.52 (0.29 – 0.93)	<0.001	0.23

Results for serum high-sensitivity C-reactive protein (hsCRP) are given as estimated geometric means and 95% confidence intervals for number of haplotypes. Results were adjusted for sex, age and study group (controls and offspring). P for interaction was calculated for the difference between controls and offspring in the trend of hsCRP over increasing number of haplotypes.

Table 3. CRP haplotype structure and frequencies

Haplotype	SNP allele			Frequency		
	rs1205	rs1800947	rs1417938	Offspring	Controls	p-value
1	T	G	T	0.335	0.344	0.57
2	T	G	A	0.336	0.315	0.17
3	C	G	T	0.260	0.273	0.38
4	C	C	T	0.069	0.068	0.94

Minor alleles are in bold. SNP=single nucleotide polymorphism

Since high levels of CRP have been associated with insulin resistance, we examined the association between serum levels of hsCRP and serum levels of non-fasted insulin as well as glucose for the group of offspring and the group of controls. Higher levels of hsCRP were consistently related to higher levels of insulin in both groups (**figure 1A**). In the group of offspring one standard deviation increase in ln hsCRP was associated with an increase in levels of ln serum insulin of 0.08 (95% confidence interval: 0.04 – 0.13) μ IU/L ($p < 0.001$). In the group of controls one standard deviation increase in ln hsCRP was associated with an increase in levels of ln serum insulin of 0.11 (0.04 – 0.19) ($p = 0.004$). The relation between hsCRP and insulin was not different between the two groups (p for interaction = 0.28). Next we examined the relation between hsCRP and glucose in the two groups. Among offspring no significant relation was observed between one standard deviation increase in ln hsCRP and glucose (mmol/L): 0.01 (-0.05 – 0.08)

($p=0.71$). (**figure 1B**). In contrast, among controls one standard deviation increase in \ln hsCRP was related with a 0.13 (0.02 – 0.24) mmol/L increase in serum glucose levels ($p=0.017$). The association between hsCRP and glucose was significantly different in the group of controls when compared to the group of offspring (p for interaction= 0.020).

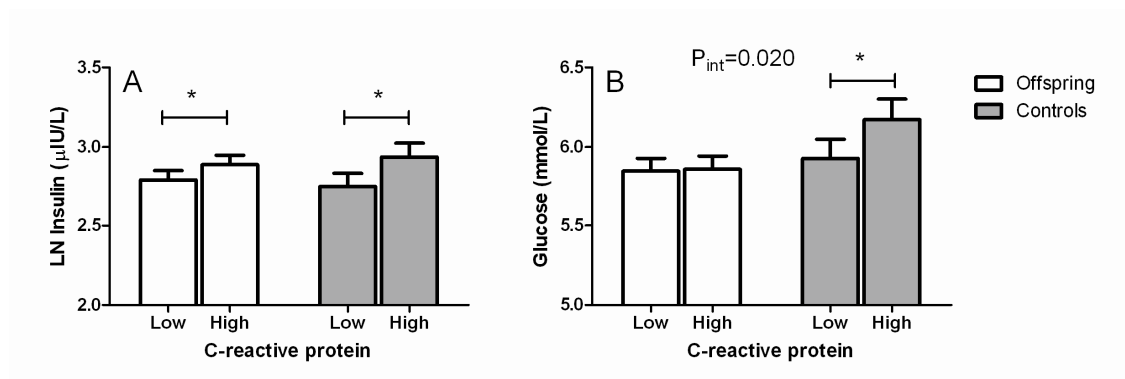

Figure 1. Association between hsCRP levels and non-fasted serum insulin levels (A) and serum glucose levels (B) for offspring and controls. For the figure HsCRP levels were dichotomized into categories of low and high hsCRP levels based on the median value of CRP of the whole population (1.15 mg/dL). * denotes P-value lower than 0.05.

If *CRP* haplotypes associate with CRP levels and CRP levels associate with markers of glucose metabolism, it could be expected that *CRP* haplotypes associate with markers of glucose metabolism. To tease out the causal relation between serum hsCRP and glucose metabolism we assessed the relationship between *CRP* haplotypes and serum levels of insulin as well as glucose. (**table 4**) In both groups, none of the haplotypes demonstrated an association with levels of serum insulin nor serum glucose.

Table 4. Association between CRP haplotypes and serum glucose parameters

Haplotype	0-copies (mean (95% CI))	1-copy (mean (95% CI))	2-copies (mean (95% CI))	P for trend	P interaction
Serum insulin (μ IU/L)					
1	16.1 (15.2 – 17.1)	16.2 (15.3 – 17.2)	16.9 (15.2 – 18.7)	0.54	0.68
2	16.4 (15.5 – 17.4)	16.0 (15.1 – 17.0)	16.6 (14.8 – 18.7)	0.84	0.15
3	16.4 (15.5 – 17.2)	16.5 (15.5 – 17.5)	14.4 (12.4 – 16.6)	0.09	0.23
4	16.1 (15.5 – 16.9)	17.3 (15.6 – 19.2)	11.9 (6.57 – 21.6)	0.41	0.83
Serum glucose (mmol/L)					
1	5.80 (5.72 – 5.87)	5.82 (5.74 – 5.89)	5.83 (5.68 – 5.97)	0.66	0.49
2	5.80 (5.73 – 5.88)	5.79 (5.71 – 5.87)	5.92 (5.76 – 6.07)	0.42	0.39
3	5.84 (5.77 – 5.91)	5.79 (5.71 – 5.87)	5.65 (5.46 – 5.85)	0.09	0.40
4	5.80 (5.74 – 5.86)	5.88 (5.74 – 6.02)	5.39 (4.67 – 6.11)	0.57	0.18

Results for serum insulin are given as estimated geometric means and 95% confidence intervals for number of haplotypes. Results for glucose are given as estimated means and 95% confidence intervals for number of haplotypes. Results were adjusted for sex, age and study group (controls and offspring). P for interaction was calculated for the difference between controls and offspring in the trend of insulin or glucose over increasing number of haplotypes.

Discussion

Earlier it has been demonstrated that the offspring from exceptionally long-lived families have a more favorable glucose metabolism when compared to population based controls.^{12;13} In the present study we show that this difference in glucose metabolism could not be explained by current differences in subclinical inflammation, as estimated from serum levels of hsCRP. We did not find a difference in the levels of hsCRP between the group of offspring from long-lived families and the group of environmentally matched controls, nor in the frequencies of the common genetic CRP variants and haplotypes. All CRP haplotypes correlated significantly with hsCRP levels, however no association was found between CRP haplotypes and insulin or glucose levels. We observed a distinct association between levels of hsCRP and levels of glucose in the

two groups: in the group of controls increasing levels of hsCRP were associated with higher non-fasted glucose levels, whereas in the group of offspring this relation was absent.

The lack of difference between the group of offspring and controls in hsCRP levels as an approximate measure for low-grade inflammation is remarkable given the higher prevalence of metabolic syndrome in the group of controls¹³. The metabolic syndrome is a combination of cardio-vascular risk factors for which the dominant underlying factor appears to be insulin resistance¹⁵. A chronic subclinical inflammatory state is considered a crucial factor in the development of insulin resistance^{5;5;16}. In accordance, insulin resistance has been shown to correspond closely with elevated levels of inflammatory markers as CRP^{17;18}. The current study demonstrates that the offspring from long-lived families compared to controls are able to tightly regulate glucose levels despite elevated markers of low-grade inflammation. This suggests that the more favorable glucose metabolism reported earlier in offspring is sustained and even more manifest under challenging conditions as for example during low-grade inflammation. Subjects from long-lived families seem to be protected by their robust insulin sensitivity against the effects of low-grade inflammation and concomitant morbidity, as for example metabolic syndrome. Alternatively, CRP might be causal in the observed difference in insulin sensitivity in response to inflammation. However, the consistent lack in both groups of association between CRP haplotypes with glucose levels strongly argues against this explanation.

During inflammation, acute phase reactants and pro-inflammatory cytokines are thought to induce a hypermetabolic state. This hypermetabolic state, which is aimed at mobilizing energy to support immune function and tissue repair, is characterized by an accelerated gluconeogenesis¹⁹ as well as induced insulin resistance resulting in elevated glucose levels²⁰ (**figure 2A**). Preserved insulin action in the offspring presumably allows for disposal of the excess glucose and/or reduced hepatic gluconeogenesis, thereby abolishing the inflammatory induced hyperglycemia (**figure 2B**). Hypothetically, a favorable balance between insulin-sensitizing and diabetogenic components underlies this phenomenon. Multiple endogenous diabetogenic components and insulin-sensitizing factors have been identified, as for example IL-6, TNF- α , PAI-1 and leptin on the one hand, and adiponectin on the other hand.²¹ Our future research will focus on unraveling the specific mechanisms of the robust glucose metabolism in offspring from long-lived families.

In conclusion, we found that the previously observed favorable glucose metabolism in middle-aged offspring from exceptionally long-lived families is unaffected by low-grade inflammation, as estimated by the inflammatory marker hsCRP, suggesting a resilience against the hyperglycemic effects of a chronic low-grade inflammatory state.

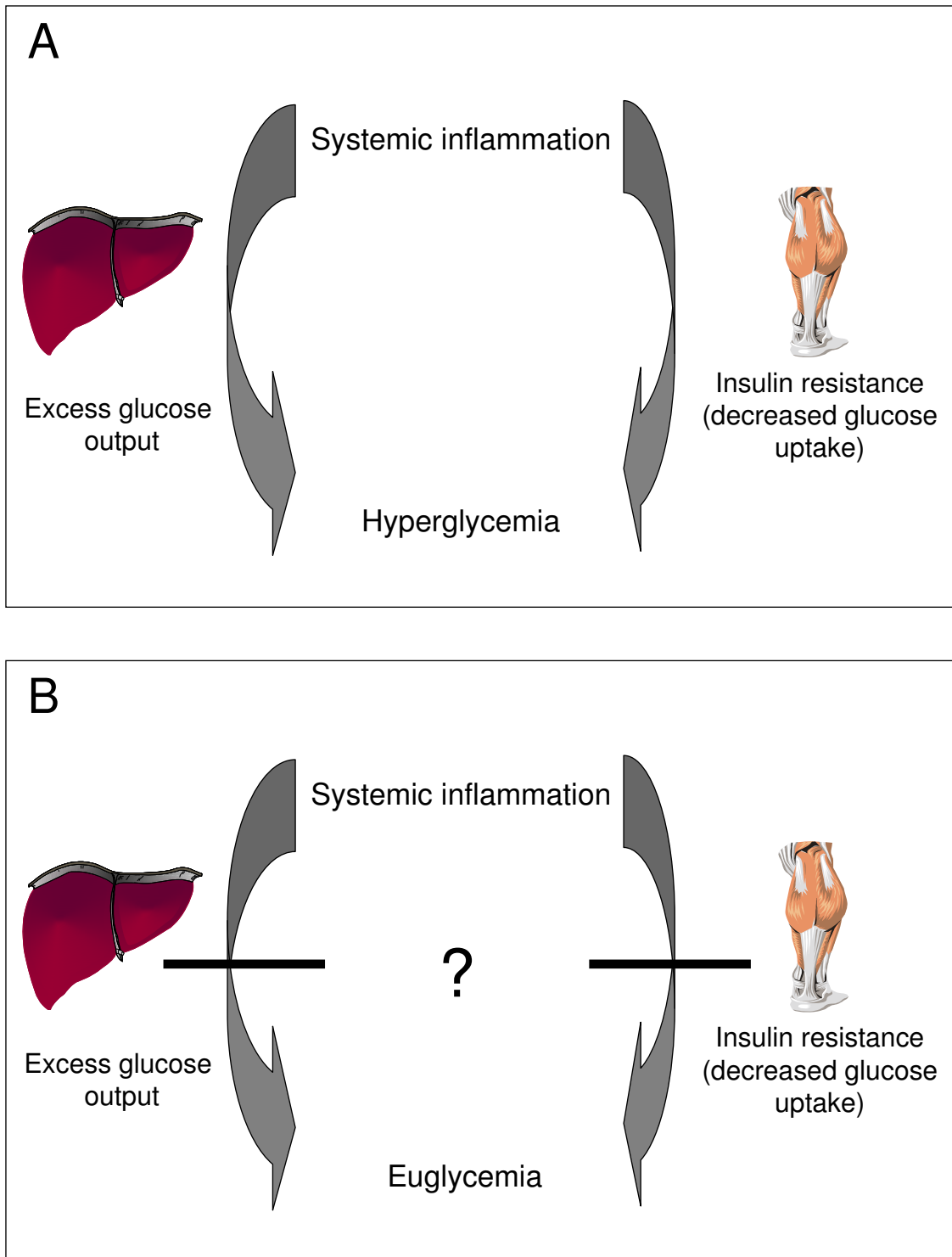

Figure 2. Mechanism of inflammatory induced hyperglycemia. The state is characterized by an accelerated hepatic gluconeogenesis as well as induced peripheral insulin resistance leading to hyperglycemia (A). Preserved insulin action in the offspring from long-lived families presumably allows for disposal of excess glucose and/or reduced hepatic gluconeogenesis, thereby abolishing the inflammatory induced hyperglycemia (B).

Acknowledgements

We thank Stella Trompet for her valuable assistance with the statistical analyses of the data. This study was supported by the Innovation Oriented research Program on Genomics (SenterNovem; IGE01014 and IGE5007), the Centre for Medical Systems Biology (CMSB), the Netherlands Genomics Initiative/Netherlands Organization for scientific research (NGI/NWO; 05040202) and the EU funded Network of Excellence Lifespan (FP6 036894).

Reference List

- (1) Shoelson SE, Lee J, Goldfine AB. Inflammation and insulin resistance. *J Clin Invest* 2006;116:1793-1801.
- (2) McFarlane SI, Banerji M, Sowers JR. Insulin resistance and cardiovascular disease. *J Clin Endocrinol Metab* 2001;86:713-718.
- (3) Shen DC, Shieh SM, Fuh MM, Wu DA, Chen YD, Reaven GM. Resistance to insulin-stimulated-glucose uptake in patients with hypertension. *J Clin Endocrinol Metab* 1988;66:580-583.
- (4) Ford ES. Body mass index, diabetes, and C-reactive protein among U.S. adults. *Diabetes Care* 1999;22:1971-1977.
- (5) Temelkova-Kurktschiev T, Siegert G, Bergmann S et al. Subclinical inflammation is strongly related to insulin resistance but not to impaired insulin secretion in a high risk population for diabetes. *Metabolism* 2002;51:743-749.
- (6) Barzilay JI, Abraham L, Heckbert SR et al. The relation of markers of inflammation to the development of glucose disorders in the elderly: the Cardiovascular Health Study. *Diabetes* 2001;50:2384-2389.
- (7) Pradhan AD, Manson JE, Rifai N, Buring JE, Ridker PM. C-reactive protein, interleukin 6, and risk of developing type 2 diabetes mellitus. *JAMA* 2001;286:327-334.
- (8) Doi Y, Kiyohara Y, Kubo M et al. Relationship between C-reactive protein and glucose levels in community-dwelling subjects without diabetes: the Hisayama Study. *Diabetes Care* 2005;28:1211-1213.
- (9) Festa A, D'Agostino R, Jr., Tracy RP, Haffner SM. C-reactive protein is more strongly related to post-glucose load glucose than to fasting glucose in non-diabetic subjects; the Insulin Resistance Atherosclerosis Study. *Diabet Med* 2002;19:939-943.
- (10) Nakanishi N, Shiraiishi T, Wada M. Association between fasting glucose and C-reactive protein in a Japanese population: the Minoh study. *Diabetes Res Clin Pract* 2005;69:88-98.

- (11) Westendorp RG, van HD, Rozing MP et al. Nonagenarian siblings and their offspring display lower risk of mortality and morbidity than sporadic nonagenarians: The Leiden Longevity Study. *J Am Geriatr Soc* 2009;57:1634-1637.
- (12) Rozing MP, Westendorp RG, Frolich M et al. Human insulin/IGF-1 and familial longevity at middle age. *Aging (Albany NY)* 2009;1:714-722.
- (13) Rozing MP, Westendorp RG, de Craen AJ et al. Favorable glucose tolerance and lower prevalence of metabolic syndrome in offspring without diabetes mellitus of nonagenarian siblings: the Leiden longevity study. *J Am Geriatr Soc* 2010;58:564-569.
- (14) Schoenmaker M, de Craen AJ, de Meijer PH et al. Evidence of genetic enrichment for exceptional survival using a family approach: the Leiden Longevity Study. *Eur J Hum Genet* 2006;14:79-84.
- (15) Hanley AJ, Karter AJ, Festa A et al. Factor analysis of metabolic syndrome using directly measured insulin sensitivity: The Insulin Resistance Atherosclerosis Study. *Diabetes* 2002;51:2642-2647.
- (16) Spranger J, Kroke A, Mohlig M et al. Inflammatory cytokines and the risk to develop type 2 diabetes: results of the prospective population-based European Prospective Investigation into Cancer and Nutrition (EPIC)-Potsdam Study. *Diabetes* 2003;52:812-817.
- (17) Festa A, D'Agostino R, Jr., Howard G, Mykkanen L, Tracy RP, Haffner SM. Chronic subclinical inflammation as part of the insulin resistance syndrome: the Insulin Resistance Atherosclerosis Study (IRAS). *Circulation* 2000;102:42-47.
- (18) Yudkin JS, Stehouwer CD, Emeis JJ, Coppel SW. C-reactive protein in healthy subjects: associations with obesity, insulin resistance, and endothelial dysfunction: a potential role for cytokines originating from adipose tissue? *Arterioscler Thromb Vasc Biol* 1999;19:972-978.
- (19) Mizock BA. Alterations in carbohydrate metabolism during stress: a review of the literature. *Am J Med* 1995;98:75-84.
- (20) Taniguchi CM, Emanuelli B, Kahn CR. Critical nodes in signalling pathways: insights into insulin action. *Nat Rev Mol Cell Biol* 2006;7:85-96.

- (21) Arai Y, Kojima T, Takayama M, Hirose N. The metabolic syndrome, IGF-1, and insulin action. *Mol Cell Endocrinol* 2009;299:124-128.

Chapter 6: Human insulin/IGF-1 and familial longevity at middle age

Maarten P. Rozing^{1,4}, Rudi G.J. Westendorp^{1,4}, Marijke Frölich³, Anton J.M. de Craen^{1,4}, Marian Beekman^{3,4}, Bastiaan T. Heijmans^{3,4}, Simon P. Mooijaart^{1,4}, Gerard-Jan Blauw¹, P. Eline Slagboom^{3,4} and Diana van Heemst¹, on behalf of the Leiden Longevity Study (LLS) Group

From the ¹Department of Gerontology and Geriatrics, Leiden University Medical Center, PO Box 9600, 2300 RC, Leiden, the Netherlands; ²Department of Clinical Chemistry, Leiden University Medical Center, PO Box 9600, 2300 RC, Leiden, the Netherlands; ³Department of Medical Statistics, section of Molecular Epidemiology, Leiden University Medical Center, PO Box 9600, 2300 RC Leiden, The Netherlands, ⁴Netherlands Consortium on Healthy Aging (NCHA).

Aging 2009 Jul; 1(8):714-22



Abstract

Recently, we have shown that compared to controls, long-lived familial nonagenarians (mean age: 93.4 years) from the Leiden Longevity Study displayed a lower mortality rate, and their middle-aged offspring displayed a lower prevalence of cardio-metabolic diseases, including diabetes mellitus. The evolutionarily conserved insulin/IGF-1 signaling (IIS) pathway has been implicated in longevity in model organisms, but its relevance for human longevity has generated much controversy. Here, we show that compared to their partners, the offspring of familial nonagenarians displayed similar non-fasted serum levels of IGF-1, IGFBP3 and insulin but lower non-fasted serum levels of glucose, indicating that familial longevity is associated with differences in insulin sensitivity.

Introduction

In Western societies, life expectancy has increased dramatically over the last century, but striking inter-individual differences in life expectancy remain ¹. Ample evidence has shown that healthy longevity is determined by a mix of genetic, environmental and chance elements. Because, as the risk of developing common and rare diseases, the odds of exceptional longevity runs in families, we designed the Leiden Longevity Study.² Recently, we have shown that the nonagenarian siblings included in the Leiden Longevity Study displayed a 41% lower risk of mortality compared to sporadic nonagenarians.³ Moreover, compared to their partners, the offspring of nonagenarian siblings displayed a significantly lower prevalence of myocardial infarction, hypertension and diabetes mellitus ³. The differences in clinical phenotype observed after selection for familial longevity are in line with the lower prevalence of cardio-metabolic disease previously detected when offspring from sporadic centenarians were compared to offspring of parents who had died at average age ⁴and when offspring from sporadic centenarians were compared to their partners ⁵. Moreover, the observed lower mortality rate at high ages and better preservation of health at middle age indicates that resilience against disease and death may have similar underlying biological mechanisms that are influenced by genetic or familial factors.

Of the genetically determined pathways that have been implicated in longevity in a variety of different model organisms, the evolutionary conserved insulin/IGF-1 signaling (IIS) pathway clearly stands out in current literature (reviewed in ⁶. Mutations in IIS components were first found to affect reproduction, metabolism, stress response and life span in *C. elegans* (reviewed in ⁷. The link between reduced IIS signaling and longevity was subsequently also observed in *D. melanogaster*. Mutants in the *D. melanogaster* insulin receptor *InR* ⁸ and in the insulin receptor substrate *CHICO* ⁹are both long-lived. Strikingly however, in both cases the long-lived phenotype was only observed for females. In addition to being long-lived, these *D. melanogaster* females are small, obese and infertile. In mice, selective disruption of the insulin receptor in the adipose tissue leads to a reduction in fat mass and extended longevity ¹⁰. Increases in lifespan were also reported in mice with deletion of insulin receptor substrate 1 (IRS1) in whole body¹¹ or IRS2 only in the brain ¹². Moreover, dwarf mice exhibiting GH deficiency or resistance, including *Prop1*^{df/d} ¹³, *Pit1*^{dw/dw} ¹⁴, *GHRHR*^{lit/li} ¹⁴ and *GHR*^{-/-} ¹⁵ all display hypoinsulinemia and enhanced insulin sensitivity along with extended longevity. In mice heterozygous for *igf1r* deletion (*Igf1r*^{+/-} ¹⁶ or containing a hypomorphic *igf1r* mutation (Midi mice ¹¹), only females, but not males, exhibited the long-lived phenotype.

Based on the similarities among the insulin/IGF-1 pathways in animals and humans the possibility that modifications in the insulin/IGF-I signaling system could also extend lifespan in

humans has been suggested. However, separating the roles of insulin and IGF-1 in mammals and their relevance for human healthy longevity has been difficult and generated much controversy. In humans, relatively low IGF-I levels have been associated with an increased risk of developing cardiovascular disease and diabetes, while relatively high IGF-I levels have been associated with an increased risk of developing cancer¹⁷. Moreover, in humans, an age-related decline in IGF-1 levels occurs¹⁸, and at old age, low IGF-1 levels are associated with frailty¹⁹, poor nutrition and cognitive decline²⁰ and an increased risk of death²¹. On the other hand, genetic variation in genes associated with down-regulation of IIS pathway has been associated with human longevity in several instances, although, when moving up the evolutionary ladder, together with an increase in genome complexity, effect sizes became smaller²². Two studies have shown evidence for a role for genetic variation in the IIS pathway in body height as well as human longevity. First, earlier we found an association between genetic variation associated with reduced IIS pathway activity and shorter stature as well as improved old age survival in sporadic female octogenarians²³. Second, offspring of sporadic female centenarians were shown to be smaller and display higher IGF-1 levels, indicative of IGF-1 insensitivity, while rare IGF-1R mutations associated with IGF-1 insensitivity were found enriched in centenarians²⁴. Here, to investigate whether these results could be generalized to familial longevity, we have compared key anthropometric measures as well as serum parameters related to insulin/IGF-1 signaling in a group of middle-aged offspring of nonagenarian siblings and a control group of their partners of the Leiden Longevity Study.

Materials and methods

Leiden Longevity Study

In the Leiden Longevity Study, 420 families were recruited consisting of long-lived Caucasian siblings together with their offspring and the partners thereof.² Families were recruited if at least two long lived siblings were alive and fulfilled the age-criterion of 89 years or older for males and 91 year or older for females. There were no selection criteria on health or demographic characteristics. For 2465 of the offspring and their partners, non-fasted serum samples taken at baseline were available for the determination of endocrine and metabolic parameters. Between November 2006 and May 2008, for 2235 of the offspring and their partners, information on medical history was obtained from the participants' general practitioner (response: 91%). For 2255 of the offspring and their partners, information on the use of medication was obtained from the participants' pharmacy (response: 92%). For 2184 of the offspring and partners a general questionnaire containing information on lifestyle and self-reported height and weight was obtained (response: 89%). For the present study, for a total of 1713 of the offspring and their partners, serum as well as information on medical history on diabetes and information on medication use and the general questionnaire were available (inclusion: 70%). After exclusion of

subjects with diabetes in medical history (n=87) and/or non-fasted glucose lower than 11 mmol/L (n=1) and/or use of glucose lowering medication (n=37), a sample of 1625 subjects was available for the current study. The Medical Ethical Committee of the Leiden University Medical Centre approved the study and informed consent was obtained from all subjects.

Biochemical analysis

All serum measurements were performed with fully automated equipment. For insulin-like growth factor-1 (IGF-1), insulin-like growth factor binding protein 3 (IGFBP3) and insulin, the Immulite 2500 from DPC (Los Angeles, CA, USA) was applied. CVs for these measurements were all below 8%. For glucose, total cholesterol, HDL-cholesterol, triglycerides, free fatty acids (FFA) the Hitachi Modular or the Cobas Integra 800, both from Roche, Almere, the Netherlands were applied. CVs of these measurements were all below 5 %.

Medication use

Lipid lowering agents were defined as fibrates, niacin, bile acid sequestrants, HMG-COA reductase inhibitors (ATC code C10).

Calculations and statistical analysis

For estimation of the level of LDL cholesterol the Friedewald formula was applied ($\text{LDL cholesterol [mmol/l]} = \text{total cholesterol} - \text{HDL cholesterol} - [\text{triglycerides}/2.2]$), whereby participants with a triglyceride concentration higher than 443 mg/dl (5 mmol/l) were excluded. For molar comparisons between IGF-1 and IGFBP3, the following molecular masses were used in the calculation: IGF-1: 7.5 kDa and IGFBP3: 28.5 kDa.

Distributions of continuous variables were examined for normality and logarithmically transformed, when appropriate and used in all calculations. Geometric means (with 95% confidence intervals (CI)) are reported for transformed variables (insulin, triglycerides, and free fatty acids). All differences in mean serum levels and anthropometrics between the groups of offspring and partner were assessed with the use of linear regression, adjusted for sex, age and correlation of sibling data using robust standard errors in STATA. The relation between IGF1/IGFBP3 molar ratio (expressed in Z-scores and restricted to values within 3 standard deviations (SDs) from the mean) and glucose was assessed with the use of a linear mixed model, adjusted for sex, age and correlation of sibling data in SPSS. The cumulative distributions of IGF-1, IGFBP3 and height were calculated in SPSS. The change in levels of IGF-1, IGFBP3 over chronological age as a continuous variable was assessed with the use of a linear mixed model, adjusted for age and correlation of sibling data in SPSS. The Statistical Package for the Social

Sciences (SPSS) program for Windows, version 14.0, and STATA version 10.0 were used for data analysis, and plots were drawn in Excel.

Results

Metabolic characteristics of offspring compared to partners

Table 1 depicts the demographic and metabolic characteristics of the groups from the Leiden Longevity Study that were used for the present study. The group of offspring proportionately contained less diabetics than the group of partners ($p = 0.001$). After exclusion of diabetics, the group of offspring had lower non-fasted serum levels of glucose ($p = 0.002$) than the group of partners. In addition, the group of offspring had a slightly more favorable lipid profile as compared to the group of partners.

IGF-1/IGFBP3 and non-fasted glucose

Next we assessed whether the lower glucose levels observed among the group of offspring relative to their partners could be driven by differences in IGF-1 axis parameters. Therefore we determined the association between serum IGF-1 / IGFBP3 molar ratios and non-fasted serum glucose levels. Higher ratios of IGF-1/ IGFBP3 were associated with lower serum glucose levels. One standard deviation increase in IGF-1/IGFBP3 ratio was associated with a decrease of 0.10 mmol/L serum glucose (SE: 0.05) among the group of partners ($p = 0.05$). The difference between partners and offspring in the change of glucose levels per standard deviation IGF-1/IGFBP3 ratio was not significant: 0.02 (SE: 0.06) nmol/L per year (p for interaction = 0.70).

Measures of the IGF-1 axis in offspring compared to partners

Table 2 shows the comparison between offspring and their partners for various IGF-1 axis parameters for males and females separately. In order to detect the effect of possible genetic differences in IGF-1 signaling between offspring and their partners, we also determined anthropometrical characteristics in subjects of both study groups (**table 2**). With regard to serum IGF-1 axis parameters, no differences were observed between the group of offspring and the group of partners in both sexes. Likewise, the study groups showed no differences in terms of sex-specific body stature, i.e. height, weight and body mass index.

Table 1. Comparison of demographics and serum parameters between offspring and partners for males and females combined

	Offspring	Partners	p-value
Demographics			
Participants - n	1171	542	
Diabetics – n (%)	46 (3.9)	42 (7.7)	0.001
Females – n (%)	633 (54.1)	302 (55.7)	0.57
Age (year)	59.2 (55.0 – 64.1)	58.8 (54.3 – 63.7)	0.15
Serum parameters (non-diabetics)			
Participants - n	1125	500	
Glucose (mmol/L)	5.69 (5.62 – 5.76)	5.87 (5.76 – 5.97)	0.002
Insulin (mU/L)**	14.4 (13.6 - 15.4)	15.4 (14.0 -16.8)	0.21
Total cholesterol (mmol/L)†	5.56 (5.47 – 5.65)	5.62 (5.52 - 5.72)	0.40
LDL cholesterol (mmol/L)†	3.32 (3.24 - 3.39)	3.37 (3.29 - 3.45)	0.33
HDL cholesterol (mmol/L)†	1.46 (1.42 - 1.49)	1.43 (1.39 - 1.47)	0.24
Triglycerides (mmol/L) **,†	1.50 (1.44 – 1.55)	1.57 (1.50 – 1.65)	0.09
Free fatty acids (mmol/L) **,†	0.27 (0.26 – 0.28)	0.27 (0.26 – 0.29)	0.38

*Mean values are presented with 95% confidence intervals. Mean values, 95% confidence intervals and p-values were calculated using a linear regression model, adjusted for age and sex. LDL denotes low-density lipoprotein and HDL high-density lipoprotein. Age is presented as median with interquartile range.

**Data are presented as geometric means and 95% confidence intervals.

† Mean values, standard error of the mean and p-value for Total cholesterol , LDL cholesterol, HDL cholesterol, LDL cholesterol/ HDL cholesterol ratio, Triglycerides, Triglycerides/ HDL cholesterol ratio, Free Fatty Acids and High sensitivity C-reactive protein were adjusted for lipid lowering agents (niacin, bile acid sequestrants, HMG-COA reductase inhibitors).

Next, we determined whether the distribution of serum IGF-1 axis parameters and anthropometrical parameters were different between offspring and partners. **Figure 1** displays the cumulative distributions of IGF-1, IGFBP3 and height among partners and offspring for both sexes separately. No differences in height were observed between offspring and partners in the lower tail of the IGF-1 and IGFBP3 distribution curves. Taken together, the cumulative distribution curves do not suggest enrichment of high or low IGF-1 axis parameters nor large or short statures among the offspring versus their partners.

Table 2. Comparison of anthropometrics and growth hormone axis parameters between offspring and partners for females separately

	Offspring*	Partners*	p-value
Females (n)	610	286	
IGF-1 axis serum parameters			
IGF-1 (nmol/L)	17.1 (16.7 – 17.5)	17.1 (16.5 – 17.7)	0.99
IGFBP3 (mg/L)	4.44 (4.36 - 4.53)	4.47 (4.36 - 4.57)	0.72
IGF-1/ IGFBP3 (molar ratio)	0.11 (0.11 – 0.11))	0.11 (0.11 – 0.11)	0.60
Anthropometrics			
Height (m)	166.8 (166.2 – 167.3)	166.9 (166.1 – 167.7)	0.79
Weight (kg)	69.2 (68.2 – 70.3)	70.2 (68.9 – 71.6)	0.25
Body Mass Index (kg/m ²)	24.9 (24.5 – 25.3)	25.2 (24.8 – 25.7)	0.25
Males (n)	515	214	
IGF-1 axis serum parameters			
IGF-1 (nmol/L)	17.5 (17.0 - 17.9)	17.3 (16.6 - 18.0)	0.75
IGFBP3 (mg/L)	4.22 (4.13 - 4.30)	4.20 (4.08 - 4.32)	0.85
IGF-1/ IGFBP3 (molar ratio)	0.12 (0.12 – 0.12)	0.12 (0.12 – 0.12)	0.82
Anthropometrics			
Height (m)	178.7 (178.1 – 179.4)	179.1 (178.2 – 180.0)	0.44
Weight (kg)	82.0 (80.9 – 83.0)	82.4 (80.8 – 84.1)	0.61
Body Mass Index (kg/m ²)	25.6 (25.4 – 25.9)	25.7 (25.2 – 26.1)	0.96

Data are presented as means with 95% confidence intervals. All analyses were adjusted for age. *Diabetic subjects were excluded from analyses.

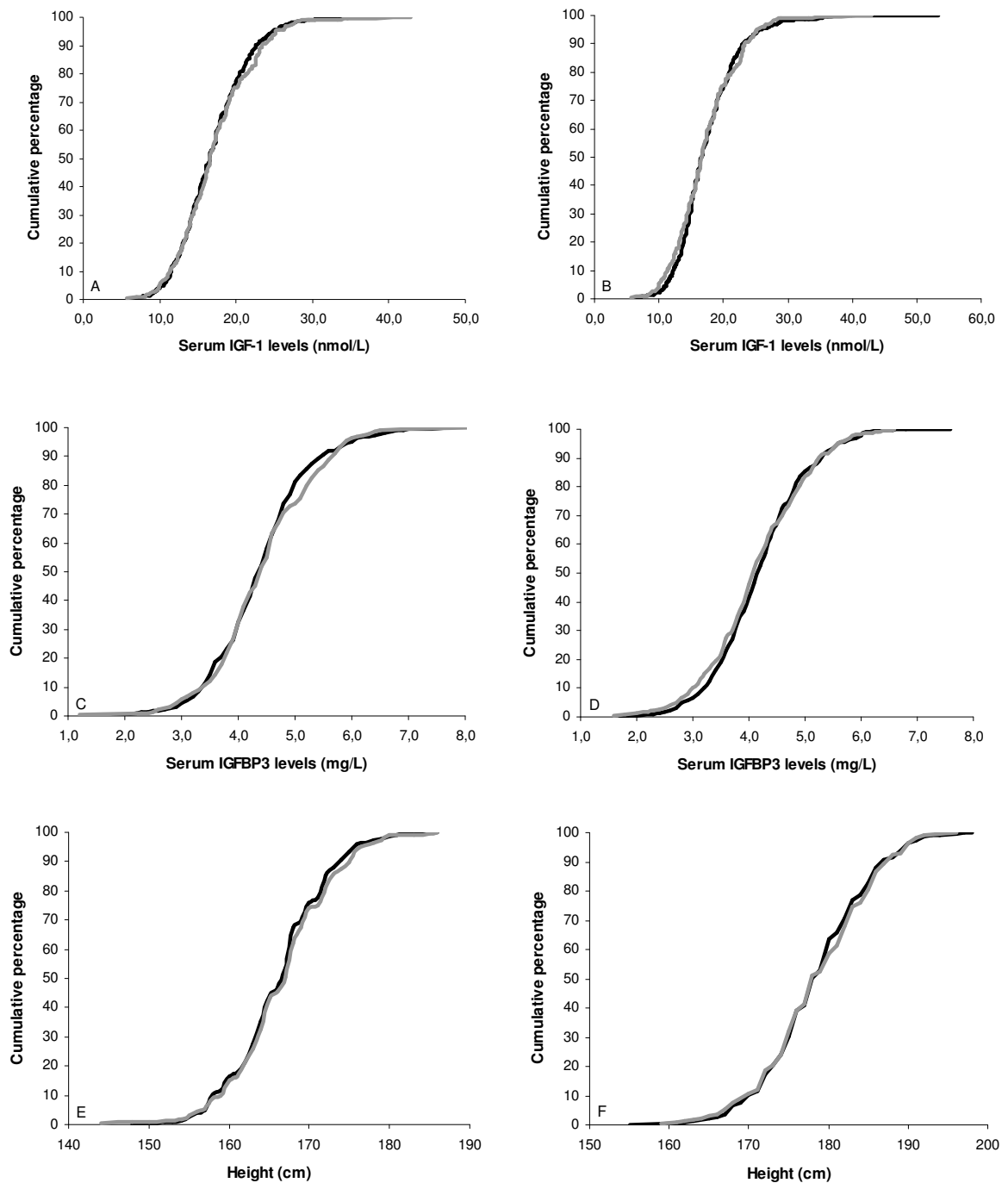
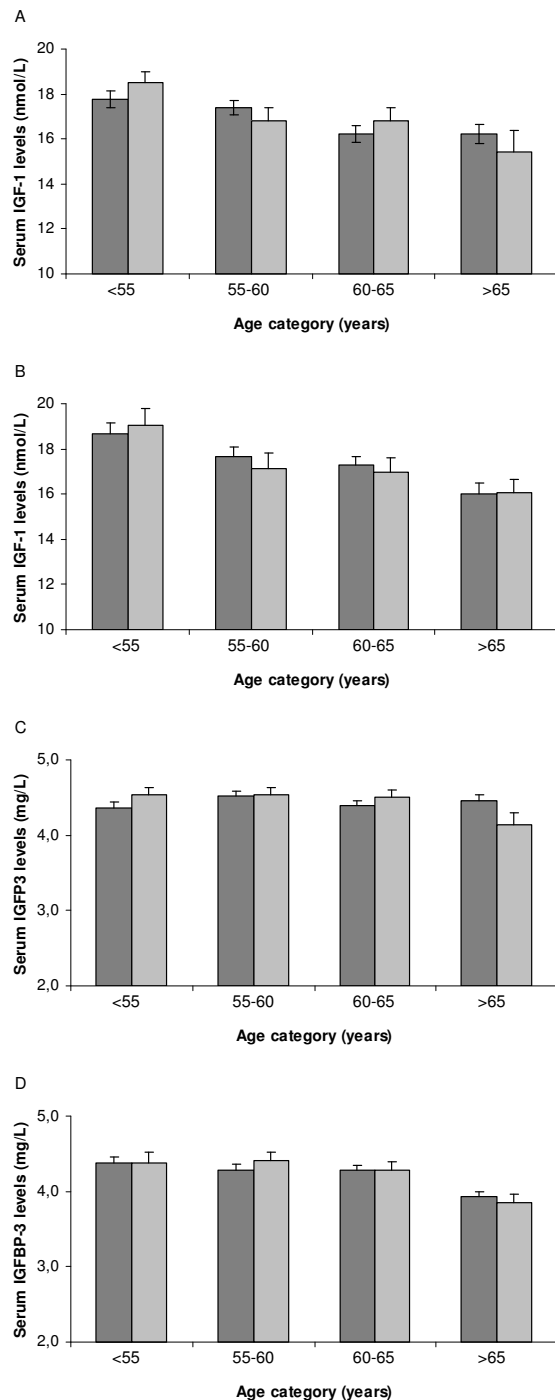

Figure 1. Cumulative distribution curves of serum IGF-1 levels, serum IGFBP3 and height. Cumulative distribution curves of IGF-1 levels for offspring and partners among females (A) and males (B); Cumulative distribution curves of IGFBP-3 levels for offspring and partners among females (C) and males (D); Cumulative distribution curves of height for offspring and partners among females (E) and males (F). Black lines represent offspring, gray lines represent partners.



IGF-1 levels have been consistently reported to progressively decline with age. To determine whether this observation applied to the groups that were used in the present study, we assessed the association between serum IGF-1 levels and serum IGFBP-3 levels with age. **Figure 2** displays the sex-specific serum IGF-1 and IGFBP-3 levels for different age categories among offspring and partners. Serum IGF-1 levels declined with age in both female partners (-0.14 (SE: 0.04) nmol per year increase; $p < 0.001$) and male partners (-0.16 (SE: 0.05) nmol/L per year increase; $p = 0.001$). The difference in annual change in serum IGF-1 levels between partners and offspring was not significant: 0.01 (SE: 0.05) nmol/L per year (p for interaction = 0.79) for females and 0.01 nmol/L (SE: 0.06) per year (p for interaction = 0.83) for males. Similarly, no differences between partners and offspring were observed in terms of annual change in serum IGFBP-3 levels: 0.01 mg/L (SE: 0.01) (p for interaction = 0.47) for females and 0.02 mg/L (SE: 0.01) (p for interaction = 0.10) for males.

Figure 2. Association between age categories and serum IGF-1 levels for offspring and partners among females (A) and males (B) and association between age categories and serum

IGFBP-3 levels for offspring and partners among females (C) and males (D). Dark bars represent offspring, light bars represent partners. Number of participants per age category for females (offspring/partners): category <55: 156/110; category 55-60: 194/83; category 60-65: 146/66; category >65: 114/27. Number of participants per age category for males (offspring/partners): category <55: 133/42; category 55-60: 140/49; category 60-65: 140/57; category >65: 102/66.

Discussion

The main findings of this study are twofold. First, consistent with the lower prevalence of diabetes observed earlier, non-fasted serum glucose levels were lower in the offspring of familial nonagenarians when compared to their partners. Second, we did not observe differences in non-fasted serum levels of IGF-1, IGFBP3 or in height between the groups of offspring and their partners, nor in the rate of the decline of levels of IGF-1 or IGFBP3 over chronological age. Taken together, these data indicate that familial longevity is associated with differences in glucose handling, which are not explained by major differences in IGF-1 and/or IGFBP3 levels.

The link between reduced IIS activity and longevity is evolutionary conserved from worms to rodents, with effects on longevity often being stronger in the female sex. However, separating the roles of insulin and IGF-1 in mammals has been very difficult and generated much controversy. Because the actions of GH, insulin and IGF-1 are largely interwoven, genetic modification of the GH/IGF-1 axis in mammals also entails differences in the regulation of glucose metabolism. Interestingly, the hallmark phenotype of all long-lived mouse models containing mutations that induce GH/IGF-1 deficiency or resistance, is their enhanced insulin sensitivity.^{6, 25} Here, we show that in non-diabetics, lower non-fasted glucose levels were observed in the offspring of familial nonagenarians as compared to their partners, which is consistent with our previous observation of a lower prevalence of diabetes in the offspring group³. Moreover, the lower non-fasted glucose levels in offspring compared to partners are suggestive of a better glucose handling and/or higher insulin sensitivity in familial longevity, which is in line with the hallmark phenotype observed in the many long-lived mammalian IIS mutants. Other data also support a link between preserved insulin sensitivity and human longevity. While insulin sensitivity generally declines with age in humans²⁵, sporadic long-lived centenarians have been shown to exhibit an exquisite insulin sensitivity, comparable to that of young adults²⁶.

The preserved insulin sensitivity observed in centenarians, occurred in relatively high levels of IGF-1/IGFBP3, which has led to the suggestion of causal link between the preserved insulin sensitivity and levels of IGF-1/IGFBP-3²⁷. In rats, IGF-1 and IGFBP3 were shown to have opposing (centrally mediated) effects on glucose metabolism, with IGF-1 acting as an insulin sensitizer, and IGFBP3 as an insulin inhibitor²⁸. Similarly, in humans, IGF-1 administration was found to increase glucose uptake and inhibit hepatic glucose production in healthy subjects²⁹, and low serum IGF-1 levels were found associated with glucose intolerance³⁰. In line with these findings, we also observed a negative association between IGF-1/IGFBP3 levels and non-fasted glucose levels in both our study groups, but neither this association nor the mean levels of IGF-1 and IGFBP3 were different between the offspring and partner group. Our observation of

improved glucose handling in the absence of major differences in IGF-1/IGFBP3 levels resembles the effects observed upon caloric restriction in humans. In contrast to model organisms, in humans, IGF-1 levels were not found to be decreased upon caloric restriction, while insulin sensitivity was increased upon caloric restriction in humans as in model organisms³¹. The lack of differences in BMI, as well as preliminary data on food intake, indicate however that the observed difference in glucose handling between the offspring group and their partners can not be explained by a lower caloric intake in the offspring group.

The observation of improved glucose handling in the absence of major differences in IGF-1/IGFBP3 in familial longevity does not rule out the possibility that genetic variations affecting IGF-1/IGFBP3 levels do contribute to human longevity. Recently, it was shown that centenarians exhibited a relative enrichment for rare genetic variants in the IGF-1 receptor which resulted in high levels of IGF-1/IGFBP3 coexisting with low levels of IGF-1 signaling²⁴. Also, earlier we and others showed that common genetic variations affecting IGF-1 signaling might contribute to differences in mortality in the population at large^{23, 32}, but the phenotypic effects associated with such variants (smaller stature, differences in serum levels of IGF-1 and/or IGFBP3) do not form a distinctive part of the hallmark phenotype of preserved glucose handling which we found associated with familial longevity.

Acknowledgments

The LLS was funded by the Innovation Oriented research Program on Genomics (SenterNovem; IGE01014 and IGE5007), the Centre for Medical Systems Biology (CMSB), the Netherlands Genomics Initiative/Netherlands Organization for scientific research (NGI/NWO; 05040202 and 050-060-810 (NCHA)) and the EU funded Network of Excellence Lifespan (FP6 036894). Prof Westendorp is supported by an unrestricted grant from the Netherlands Genomics Initiative (NCHA 050-060-810). We thank all participants of the Leiden Longevity Study for their consistent cooperation, as well all participating general practitioners and pharmacists, the secretary staff (Meriam H van der Star, Ellen H Bemer-Oorschot) and research nurses (Corrie J Groenendijk), data managers (Karin H Herbschleb) for their expert contribution.

Reference List

- (1) Oeppen J, Vaupel JW. Demography. Broken limits to life expectancy. *Science* 2002 May 10;296(5570):1029-31.
- (2) Schoenmaker M, de Craen AJ, de Meijer PH et al. Evidence of genetic enrichment for exceptional survival using a family approach: the Leiden Longevity Study. *Eur J Hum Genet* 2006 January;14(1):79-84.
- (3) Westendorp RGJ, van Heemst D, Rozing MP et al. Nonagenarian siblings and their offspring display lower risk of mortality and morbidity than sporadic nonagenarians: The Leiden Longevity Study. *JAGS*. In press 2009.
- (4) Terry DF, Wilcox M, McCormick MA, Lawler E, Perls TT. Cardiovascular advantages among the offspring of centenarians. *J Gerontol A Biol Sci Med Sci* 2003 May;58(5):M425-M431.
- (5) Atzmon G, Schechter C, Greiner W, Davidson D, Rennert G, Barzilai N. Clinical phenotype of families with longevity. *J Am Geriatr Soc* 2004 February;52(2):274-7.
- (6) Bartke A. Impact of reduced insulin-like growth factor-1/insulin signaling on aging in mammals: novel findings. *Aging Cell* 2008 June;7(3):285-90.
- (7) Kenyon C. A conserved regulatory system for aging. *Cell* 2001 April 20;105(2):165-8.
- (8) Tatar M, Kopelman A, Epstein D, Tu MP, Yin CM, Garofalo RS. A mutant *Drosophila* insulin receptor homolog that extends life-span and impairs neuroendocrine function. *Science* 2001 April 6;292(5514):107-10.
- (9) Clancy DJ, Gems D, Harshman LG et al. Extension of life-span by loss of CHICO, a *Drosophila* insulin receptor substrate protein. *Science* 2001 April 6;292(5514):104-6.
- (10) Bluher M, Kahn BB, Kahn CR. Extended longevity in mice lacking the insulin receptor in adipose tissue. *Science* 2003 January 24;299(5606):572-4.
- (11) Selman C, Lingard S, Choudhury AI et al. Evidence for lifespan extension and delayed age-related biomarkers in insulin receptor substrate 1 null mice. *FASEB J* 2008 March;22(3):807-18.

Chapter 6

- (12) Taguchi A, Wartschow LM, White MF. Brain IRS2 signaling coordinates life span and nutrient homeostasis. *Science* 2007 July 20;317(5836):369-72.
- (13) Brown-Borg HM, Borg KE, Meliska CJ, Bartke A. Dwarf mice and the ageing process. *Nature* 1996 November 7;384(6604):33.
- (14) Flurkey K, Papaconstantinou J, Miller RA, Harrison DE. Lifespan extension and delayed immune and collagen aging in mutant mice with defects in growth hormone production. *Proc Natl Acad Sci U S A* 2001 June 5;98(12):6736-41.
- (15) Chandrashekar V, Bartke A, Coschigano KT, Kopchick JJ. Pituitary and testicular function in growth hormone receptor gene knockout mice. *Endocrinology* 1999 March;140(3):1082-8.
- (16) Holzenberger M, Dupont J, Ducos B et al. IGF-1 receptor regulates lifespan and resistance to oxidative stress in mice. *Nature* 2003 January 9;421(6919):182-7.
- (17) Juul A. Serum levels of insulin-like growth factor I and its binding proteins in health and disease. *Growth Horm IGF Res* 2003 August;13(4):113-70.
- (18) Iranmanesh A, Lizarralde G, Veldhuis JD. Age and relative adiposity are specific negative determinants of the frequency and amplitude of growth hormone (GH) secretory bursts and the half-life of endogenous GH in healthy men. *J Clin Endocrinol Metab* 1991 November;73(5):1081-8.
- (19) Lamberts SW, van den Beld AW, van der Lely AJ. The endocrinology of aging. *Science* 1997 October 17;278(5337):419-24.
- (20) Arai Y, Hirose N, Yamamura K et al. Serum insulin-like growth factor-1 in centenarians: implications of IGF-1 as a rapid turnover protein. *J Gerontol A Biol Sci Med Sci* 2001 February;56(2):M79-M82.
- (21) Cappola AR, Xue QL, Ferrucci L, Guralnik JM, Volpato S, Fried LP. Insulin-like growth factor I and interleukin-6 contribute synergistically to disability and mortality in older women. *J Clin Endocrinol Metab* 2003 May;88(5):2019-25.
- (22) Kuningas M, Mooijaart SP, van Heemst D, Zwaan BJ, Slagboom PE, Westendorp RG. Genes encoding longevity: from model organisms to humans. *Aging Cell* 2008 March;7(2):270-80.

- (23) van Heemst D, Beekman M, Mooijaart SP et al. Reduced insulin/IGF-1 signalling and human longevity. *Aging Cell* 2005 April;4(2):79-85.
- (24) Suh Y, Atzmon G, Cho MO et al. Functionally significant insulin-like growth factor I receptor mutations in centenarians. *Proc Natl Acad Sci U S A* 2008 March 4;105(9):3438-42.
- (25) Ferrannini E, Vichi S, Beck-Nielsen H, Laakso M, Paolisso G, Smith U. Insulin action and age. European Group for the Study of Insulin Resistance (EGIR). *Diabetes* 1996 July;45(7):947-53.
- (26) Paolisso G, Gambardella A, Ammendola S et al. Glucose tolerance and insulin action in healthy centenarians. *Am J Physiol* 1996 May;270(5 Pt 1):E890-E894.
- (27) Paolisso G, Ammendola S, Del BA et al. Serum levels of insulin-like growth factor-I (IGF-I) and IGF-binding protein-3 in healthy centenarians: relationship with plasma leptin and lipid concentrations, insulin action, and cognitive function. *J Clin Endocrinol Metab* 1997 July;82(7):2204-9.
- (28) Muzumdar RH, Ma X, Fishman S et al. Central and opposing effects of IGF-I and IGF-binding protein-3 on systemic insulin action. *Diabetes* 2006 October;55(10):2788-96.
- (29) Sherwin RS, Borg WP, Boulware SD. Metabolic effects of insulin-like growth factor I in normal humans. *Horm Res* 1994;41 Suppl 2:97-101.
- (30) Sandhu MS, Heald AH, Gibson JM, Cruickshank JK, Dunger DB, Wareham NJ. Circulating concentrations of insulin-like growth factor-I and development of glucose intolerance: a prospective observational study. *Lancet* 2002 May 18;359(9319):1740-5.
- (31) Redman LM, Martin CK, Williamson DA, Ravussin E. Effect of caloric restriction in non-obese humans on physiological, psychological and behavioral outcomes. *Physiol Behav* 2008 August 6;94(5):643-8.
- (32) Bonafe M, Barbieri M, Marchegiani F et al. Polymorphic variants of insulin-like growth factor I (IGF-I) receptor and phosphoinositide 3-kinase genes affect IGF-I plasma levels and human longevity: cues for an evolutionarily conserved mechanism of life span control. *J Clin Endocrinol Metab* 2003 July;88(7):3299-304.

Chapter 7: Reduced serum IGF-1 and familial longevity

Maarten P. Rozing^{1, 4}, Jeanine. J. Houwing-Duistermaat², P. Eline Slagboom^{3,4}, Marian Beekman^{3,4}, Anton J.M. de Craen^{1, 4}, Rudi G.J. Westendorp^{1, 4} and Diana van Heemst^{1, 4}, on behalf of the Leiden Longevity Study (LLS) Group

From the ¹Department of Gerontology and Geriatrics, Leiden University Medical Center, PO Box 9600, 2300 RC, Leiden, the Netherlands; ²Department of Medical Statistics, ³section Molecular Epidemiology, Leiden University Medical Center, PO Box 9600, 2300 RC Leiden, The Netherlands, ⁴Netherlands Consortium of Healthy Aging (NCHA).



Abstract

Reduced insulin/ IGF-1 signaling has been associated with life span extension in various model organisms. However, the role of insulin/ IGF-1 signaling in human longevity remains controversial. In this study we related serum IGF-1 levels in nonagenarian siblings from the Leiden Longevity Study to the family mortality history score of their parents. We found that a lower parental family mortality history score (less mortality) was associated with lower IGF-1 serum levels in female but not in male nonagenarian siblings. These findings suggest that reduced IGF-1 activity is associated with exceptional familial longevity.

Introduction

The role of the evolutionarily conserved insulin/ insulin-like growth factor (IGF-1) signaling (IIS) pathway in the regulation of lifespan is well documented in worms ¹, flies ², and rodents ^{3, 4}. Genetic mutations that inhibit IIS activation prolong lifespan in these organisms, particularly in the female sex. The involvement of IIS modulation in human longevity is less clear. In agreement with the findings in model organisms, reduced IIS pathway activity was associated with old age survival in sporadic female octogenarians and different cohorts of nonagenarians ^{5, 6}. Furthermore, centenarians were shown to be enriched for rare IGF-1R mutations associated with IGF-1 resistance ⁷. In contrast to these apparent beneficial effects, lower serum IGF-1 levels in humans have been associated with an increased risk of developing cardiovascular disease and diabetes ⁸.

In order to identify heritable determinants of longevity we set up the Leiden Longevity Study. This study includes nonagenarian siblings, recruited from 421 Caucasian families based on proband siblings that both exhibit exceptional longevity ⁹ and their offspring ¹⁰. Earlier we reported on the lack of differences in IGF-1 serum levels between middle-aged offspring of familial nonagenarians and controls ¹¹. In the nonagenarian siblings however, comparative analysis IGF-1 axis parameters is hampered by their extreme age, precluding the use of age-matched controls. Therefore we calculated a family mortality history score describing the mortality of the parents of the nonagenarian siblings ¹². We reasoned that in nonagenarian siblings from parents with a lower family mortality history score (i.e. lower than expected mortality), characteristics associated with longevity are more prominent than in nonagenarian siblings from parents with a higher family mortality history score. In the current study we aim to examine the association between parental family mortality history score of the parents of the nonagenarian siblings and serum parameters related to insulin/IGF-1 signaling in the nonagenarian siblings.

Materials and methods

In the Leiden Longevity Study, 421 families were recruited consisting of long-lived Caucasian siblings together with their offspring and the partners thereof. For the current study, data on IGF-1 and IGFBP3 levels were available for 859 of the 944 nonagenarian participants from the Leiden Longevity Study. The Medical Ethical Committee of the Leiden University Medical Centre approved the study and informed consent was obtained from all subjects. For details on enrollment please see previous publications ^{10, 11}.

All serum measurements were performed with fully automated equipment. For IGF-1 and IGFBP3, the Modular E170 was used, for high sensitivity C-reactive protein (hsCRP) the Cobas

Integra 800 was used, both from Roche, Almere, the Netherlands. The coefficients of variation of these measurements were all below 5 %. ADL, IADL, MMSE and self perceived health was available for 779 participants.

Data on body height were available for 77 participants. Body height was measured using a tape measure when standing upright without shoes. Disability was determined using the activities of daily living scale (ADL) and Instrumental Activities of Daily Living scale (IADL).¹³ Global cognitive function was assessed with the Mini Mental State Examination (MMSE). Self perceived health was assessed by one question with five alternatives: 1 = 'very good', to 5 = 'very poor'. ADL, IADL, MMSE and self perceived health was available for 779 participants.

For each parent we computed the sex and birth cohort cumulative hazards using the life tables of the Dutch population. Note that since both parents are deceased one minus the cumulative hazard equals the martingale residual. The martingale residual is defined as the difference between the event status (0 if alive, 1 if deceased) and the cumulative hazard at the observed age (current age or age at death). The sum of the martingale residuals measures the deviation of survival of the parents with respect to their birth cohort. Therefore negative values mean excess survival and positive values mean excess mortality.

The association between family mortality history score and IGF-1 axis parameters was assessed using a linear mixed model with a random sibship effect to model correlation of sibling data. Distributions of continuous variables were examined for normality and logarithmically transformed when appropriate (high sensitivity C-reactive protein). 17 individuals with serum IGF-1 or IGFBP3 levels beyond 3 standard deviations from the mean were excluded from the analyses: thus, in total 842 individuals were included in the analyses. The Statistical Package for the Social Sciences (SPSS) program for Windows, version 14.0, was used for data analysis. Graphs were drawn using Graph Pad Prism version 5.

Results

The baseline features of the study population are displayed in **table 1**. The median age of the population was 92.9 years and the population included 518 females (61.5%).

Table 1. Baseline characteristics of the study population

	Study population
Number participants (N)	842
Males (N, %)	518 (61.5)
Age (year)	92.9 (91.4 – 94.8)
IGF-1 (nmol/L)	10.0 (7.6 – 12.9)
IGFBP3 (mg/L)	2.9 (2.4 – 3.4)
IGF-1 IGFBP3- Ratio	0.10 (0.08 – 0.12)
High sensitivity C-reactive protein (mg/L)	2.8 (1.3 – 5.7)
Disability (points)	
ADLs	18 (15 - 20)
Instrumental ADLs	8 (4 - 11)
Mini Mental State Examination	26 (22 - 28)
Self perceived health	3 (3 - 4)

Unless stated otherwise, all data are given as median values with interquartile range (25% - 75%).

Table 2 shows the association between the family mortality history score and the different IGF-1 axis parameters for males and females separately according to two models. Model 1 was adjusted for age only. As IGF-1 levels are known to be affected by illness, we repeated all analyses after adjustment for various parameters of physical disability in model 2. In both models a lower family mortality history score (lower than expected mortality) was associated with lower IGF-1 levels in females, but not in males (**figure 1**). No significant relation was observed between the family mortality history score and levels of IGFBP3 or the ratio of IGF-1 over IGFBP3, although in females a higher family mortality history score tended to be associated with a higher IGF-1 IGFBP3 molar ratio.

Next we determined the relation between family mortality history score and height for females and males separately. Although far from significant, in figure 2 higher family mortality history tended to be related to increased height in females ($p=0.16$), but not in males ($p=0.95$).

Table 2. Association between Family Mortality History Score and IGF-1 axis parameters

	Change per Family History Score Unit	p-value
Model 1: adjusted for age		
Females		
IGF-1 (nmol/L)	0.19 (-0.004 – 0.38)	0.055
IGFBP3 (mg/L)	0.02 (-0.02 – 0.07)	0.25
IGF-1 IGFBP-3 Molar Ratio (*10 ⁴)	9.3 (-3.0 – 21.6)	0.14
Males		
IGF-1 (nmol/L)	0.003 (-0.24 – 0.25)	0.98
IGFBP3 (mg/L)	-0.01 (-0.06 – 0.04)	0.78
IGF-1 IGFBP3 Molar Ratio (*10 ⁴)	4.2 (-12.4 – 20.8)	0.62
Model 2: as model 1 adjusted for ADLs, IADLs, MMSE, SPH and logCRP		
Females		
IGF-1 (nmol/L)	0.26 (0.05 – 0.46)	0.017
IGFBP3 (mg/L)	0.04 (-0.01 – 0.08)	0.11
IGF-1 IGFBP3 Molar Ratio (*10 ⁴)	12.0 (-0.6 – 24.6)	0.061
Males		
IGF-1 (nmol/L)	0.05 (-0.21 – 0.32)	0.70
IGFBP-3 (mg/L)	-0.01 (-0.06 – 0.04)	0.74
IGF-1 IGFBP3 Molar Ratio (*10 ⁴)	9.8 (8.0 – 27.6)	0.28

Data are presented as mean change per one unit increase in Family Mortality History Score and 95% confidence intervals. Results were adjusted for sex and age, MMSE, ADLs, instrumental ADLs, High sensitivity C - reactive protein and Self Perceived Health.

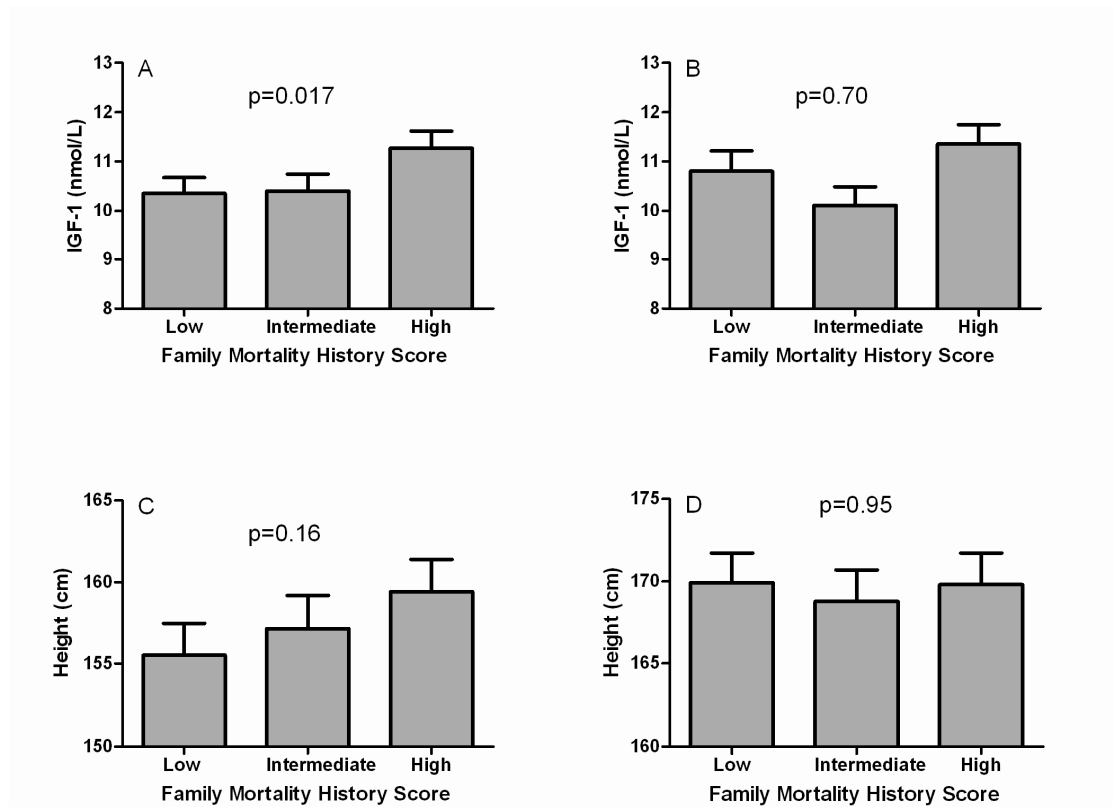

Figure 1. Association between family mortality history score and IGF-1 serum levels, for females (A) and males (B). Bars represent tertiles of family mortality history scores adjusted for age, ADLs, IADLs, MMSE, self perceived health and log serum high sensitivity C-reactive protein. Association between family mortality history score and height for females (C) and males (D). Bars represent tertiles of family mortality history scores. Results were adjusted for age.

Discussion

Our findings suggest that lower serum IGF-1 levels are a heritable determinant for exceptional longevity as observed in the Leiden Longevity Study. These results concur with the observed association between reduced IIS activity and longevity in various model organisms as well as in human studies showing life extending effects of reduced IGF-1 signaling^{1-4, 6}. In these studies lifespan extending effects were mostly confined to females, in agreement with the results presented here.

Our findings are in contrast with the lack of difference in IGF-1 serum levels previously observed between middle-aged offspring of familial nonagenarians and controls. These contrasting results may be partly due to differences in age. The estimated contribution of genetic factors is modest (20-30%) but was shown to become more important and specific at higher ages^{14, 15}. Therefore it is possible that the effects of genetic variation in the IIS pathway only become detectable at

Chapter 7

advanced ages. In line, the association between FOXO3A and longevity was for example found to be stronger in centenarians than in nonagenarians ¹⁶. Another possible explanation for these contrasting observations could be differences in imprinting of the IGF-1 gene, reflecting historical differences in maternal nutrition between the two generations ¹⁷.

Several weaknesses of our study should be considered. First, anthropometric data were only available for a small subset of the studied population. The non-significant association between family mortality history scores and small stature could therefore well be due to lack of power ⁶.

In conclusion, we present preliminary evidence that in females but not in males reduced IGF-1 levels are associated with exceptional familial longevity.

Reference List

- (1) Kenyon C, Chang J, Gensch E, Rudner A, Tabtiang R. A *C. elegans* mutant that lives twice as long as wild type. *Nature* 1993 December 2;366(6454):461-4.
- (2) Tatar M, Kopelman A, Epstein D, Tu MP, Yin CM, Garofalo RS. A mutant *Drosophila* insulin receptor homolog that extends life-span and impairs neuroendocrine function. *Science* 2001 April 6;292(5514):107-10.
- (3) Brown-Borg HM, Borg KE, Meliska CJ, Bartke A. Dwarf mice and the ageing process. *Nature* 1996 November 7;384(6604):33.
- (4) Holzenberger M, Dupont J, Ducos B et al. IGF-1 receptor regulates lifespan and resistance to oxidative stress in mice. *Nature* 2003 January 9;421(6919):182-7.
- (5) Pawlikowska L, Hu D, Huntsman S et al. Association of common genetic variation in the insulin/IGF1 signaling pathway with human longevity. *Aging Cell* 2009 August;8(4):460-72.
- (6) Van Heemst D, Beekman M, Mooijaart SP et al. Reduced insulin/IGF-1 signalling and human longevity. *Aging Cell* 2005 April;4(2):79-85.
- (7) Suh Y, Atzmon G, Cho MO et al. Functionally significant insulin-like growth factor I receptor mutations in centenarians. *Proc Natl Acad Sci U S A* 2008 March 4;105(9):3438-42.
- (8) Juul A. Serum levels of insulin-like growth factor I and its binding proteins in health and disease. *Growth Horm IGF Res* 2003 August;13(4):113-70.
- (9) Schoenmaker M, de Craen AJ, de Meijer PH et al. Evidence of genetic enrichment for exceptional survival using a family approach: the Leiden Longevity Study. *Eur J Hum Genet* 2006 January;14(1):79-84.
- (10) Westendorp RG, van Heemst D, Rozing MP et al. Nonagenarian siblings and their offspring display lower risk of mortality and morbidity than sporadic nonagenarians: The Leiden Longevity Study. *J Am Geriatr Soc* 2009 September;57(9):1634-7.
- (11) Rozing MP, Westendorp RG, Frolich M et al. Human insulin/IGF-1 and familial longevity at middle age. *Aging (Albany NY)* 2009 August;1(8):714-22.

Chapter 7

- (12) Houwing-Duistermaat JJ, Callegaro A, Beekman M, Westendorp RG, Slagboom PE, van Houwelingen JC. Weighted statistics for aggregation and linkage analysis of human longevity in selected families: the Leiden Longevity Study. *Stat Med* 2009 January 15;28(1):140-51.
- (13) Bootsma-van der WA, Gussekloo J, de Craen AJ et al. Disability in the oldest old: "can do" or "do do"? *J Am Geriatr Soc* 2001 July;49(7):909-14.
- (14) Passarino G, Montesanto A, Dato S et al. Sex and age specificity of susceptibility genes modulating survival at old age. *Hum Hered* 2006;62(4):213-20.
- (15) von Hjelmborg JB, Iachine I, Skytthe A et al. Genetic influence on human lifespan and longevity. *Hum Genet* 2006 April;119(3):312-21.
- (16) Flachsbart F, Caliebe A, Kleindorp R et al. Association of FOXO3A variation with human longevity confirmed in German centenarians. *Proc Natl Acad Sci U S A* 2009 February 24;106(8):2700-5.
- (17) Drake NM, Park YJ, Shirali AS, Cleland TA, Soloway PD. Imprint switch mutations at Rasgrf1 support conflict hypothesis of imprinting and define a growth control mechanism upstream of IGF1. *Mamm Genome* 2009 September;20(9-10):654-63.

Chapter 8: Low serum free triiodothyronine levels mark familial longevity: the Leiden Longevity Study

Maarten P. Rozing^{1,4}, Rudi G.J. Westendorp^{1,4}, Anton J.M. de Craen^{1,4}, Marijke Frölich², Bastiaan T. Heijmans^{3,4}, Marian Beekman^{3,4}, Carolien Wijsman^{1,4}, Simon P. Mooijaart^{1,4}, Gerard-Jan Blauw¹, P. Eline Slagboom^{3,4}, and Diana van Heemst^{1,4}, on behalf of the Leiden Longevity Study (LLS) Group

From the ¹Department of Gerontology and Geriatrics, Leiden University Medical Center, PO Box 9600, 2300 RC, Leiden, the Netherlands; ³Department of Clinical Chemistry, Leiden University Medical Center, PO Box 9600, 2300 RC, Leiden, the Netherlands; ⁴Department of Molecular Epidemiology, Leiden University Medical Center, PO Box 9600, 2300 RC Leiden, The Netherlands, ²Netherlands Consortium of Healthy Aging (NCHA).

J Geront A Biol Sci Med Sci 2010 Apr;65(4):365-8



Abstract

The hypothalamo–pituitary–thyroid axis has been widely implicated in modulating the aging process. Life extension effects associated with low thyroid hormone levels have been reported in multiple animal models. In human populations, an association was observed between low thyroid function and longevity at old age, but the beneficial effects of low thyroid hormone metabolism at middle age remain elusive. We have compared serum thyroid hormone function parameters in a group of middle-aged offspring of long-living nonagenarian siblings and a control group of their partners, all participants of the Leiden Longevity Study. When compared to their partners the group of offspring of nonagenarian siblings showed a trend towards higher serum thyrotropin levels (1.65 vs. 1.57 mU/L, $p=0.11$) in conjunction with lower free thyroxine levels (15.0 vs. 15.2 pmol/L, $p=0.045$) and lower free triiodothyronine levels (4.08 vs 4.14 pmol/L, $p=0.024$). Compared to their partners, the group of offspring of nonagenarian siblings show a lower thyroidal sensitivity to thyrotropin. These findings suggest that the favorable role of low thyroid hormone metabolism on health and longevity in model organism is applicable to humans as well.

Introduction

The hypothalamo–pituitary–thyroid axis has been widely implicated in modulating the aging process. Life extension effects associated with low thyroid hormone levels have been reported in multiple animal models. In neonatal rats, induction of hypothyroidism results in a moderate extension of lifespan¹. Similarly, low thyroid hormone levels are characteristic of murine pituitary mutants with delayed aging: long-lived Ames and Snell dwarf mice show traits that are hypothesized to be related to thyroid hormone deficiency, including hypothermia and delayed maturation^{2,3}. Administration of thyroid hormone during adulthood partly diminishes longevity in Snell dwarf mice⁴. Another very long-living mammal, the naked mole rat (*Heterocephalus glaber*) also has very low serum thyroxine levels⁵.

In agreement with the findings in animals, various studies have shown an association between low thyroid function and improved longevity in elderly humans. In the general population of the oldest old, high levels of thyrotropin are associated with a prolonged life span^{6,7}. In contrast, low serum thyrotropin and higher serum free thyroxin levels are related to an increased risk of cardiovascular mortality⁸. These findings suggest a favorable effect of thyroid hypofunction on healthy aging in humans.

However, comparative cross-sectional studies involving long-lived subjects are hampered by the lack of proper controls. These studies remain inconclusive as to whether thyroid hypofunction in extreme old age represents an adaptive mechanism or is the result of selective survival of subjects with lifelong thyroid hypofunction. We designed the Leiden Longevity Study in order to identify familial determinants of healthy longevity in nonagenarian siblings and their offspring, who are enriched for heritable influences on morbidity and mortality.⁹ The aim of this study was to assess whether low thyroid function observed in extreme old age is already present in middle-aged individuals with higher than average life expectancy. To this end we have compared thyroid hormone function parameters in a group of middle-aged offspring of long-living nonagenarian siblings and a control group of their partners of the Leiden Longevity Study.

Materials and methods

Leiden Longevity Study

In the Leiden Longevity Study, 420 families were recruited consisting of long-lived Caucasian siblings together with their offspring and the partners thereof. Families were recruited if at least two long lived siblings were alive and fulfilled the age-criterion of 89 years or older for males and 91 year or older for females. There were no selection criteria on health or demographic characteristics. For 2465 of the offspring and their partners, non-fasted serum samples taken at

Chapter 8

baseline were available for the determination of endocrine and metabolic parameters. Between November 2006 and May 2008, for 2235 of the offspring and their partners, information on medical history was obtained from the participants' treating physicians (response: 90.7%). For 2255 of the offspring and their partners, information on the use of medication was obtained from the participants' pharmacist (response: 91.5%). For 2184 of the offspring and partners a general questionnaire containing information on lifestyle and self-reported height and weight was obtained (response: 89.0%). For the present study, for a total of 1738 of the offspring and their partners, serum as well as information on medical history and information on medication use and the general questionnaire were available (inclusion: 69.5%). The Medical Ethical Committee of the Leiden University Medical Centre approved the study and informed consent was obtained from all subjects.

For the current study participants using thyroid medication were excluded from the analyses: 32 (2.7%) offspring using thyroid medication were excluded and 11 (2.0%) partners were excluded from the analyses. Thyroid hormone medication was defined as thyroid or anti-thyroid preparations (ATC code H03). Outliers were defined as serum thyroid parameters (thyrotropin, thyroxine and triiodothyronine) beyond three standard deviations below or above the standard error of the mean. Outliers were excluded from the analyses. 34 offspring with serum thyroid parameters beyond 3 standard deviations from the mean were excluded from the analyses, of which one individual was clinically hyperthyroid (thyrotropin <0.3 mU/L and free thyroxine >24 pmol/L) and three individuals clinically hypothyroid (thyrotropin >4.8 mU/L and free thyroxine <10 pmol/L). 9 partners with serum thyroid parameters beyond 3 standard deviations from the mean were excluded from the analyses, of which 2 individuals were clinically hyperthyroid (thyrotropin <0.3 mU/L and free thyroxine >24 pmol/L). In our laboratory, the reference values for thyrotropin were 0.3-4.8 mIU/L; free thyroxine: 10-24 pmol/L; and free triiodothyronine, 2.5-5.5 pmol/L.

Biochemical analysis

All serum measurements were performed with fully automated equipment. For thyrotropin, free thyroxine and free triiodothyronine, the Modular E170 was used from Roche, Almere, the Netherlands. The coefficients of variation of these measurements were all below 5 %.

Statistical analysis

Distributions of continuous variables were examined for normality and logarithmically transformed, when appropriate and used in all calculations. Geometric means (with 95% confidence intervals (CI)) are reported for thyrotropin. All differences between offspring and

partner categories were assessed with the use of linear mixed modeling, adjusted for age and correlation of sibling data. Differences in age and body mass index between the two groups of offspring and partners were tested using a Mann-Whitney rank sum test. Differences in smoking behavior and gender distribution between the group of offspring and the group of partners were calculated using a Chi-Square test. The Statistical Package for the Social Sciences (SPSS) program for Windows, version 16.0, was used for data analysis.

Results

Table 1 shows the baseline characteristics for the two study populations. In total, we used data on 1119 middle-aged offspring of nonagenarian siblings and 533 of their middle-aged partners. The group of female offspring was slightly older than the group of female partners, whilst the group of male offspring was younger than the group of male partners. No significant differences between the two groups were observed with regard body mass index and current smoking status.

Table 1. Baseline characteristics of study populations

	Offspring	Partners	P-value
Females – (n)	596	293	
Age (year)	58.9 (54.9 – 64.0)	57.4 (52.4 – 61.9)	<0.001
Height (cm)	166.8 (166.2 – 167.3)	167.0 (166.2 – 167.7)	0.62
Weight (kg)	69.6 (68.6 – 70.7)	70.8 (69.4 – 72.2)	0.17
Body Mass Index (kg/m ²)	25.0 (24.7 – 25.4)	25.4 (24.9 – 25.9)	0.20
Currently smoking (n, %)	75 (12.8%)	45 (15.4%)	0.30
Males – (n)	523	240	
Age (year)	59.4 (55.0 – 64.2)	61.4 (56.2 – 66.3)	0.001
Height (cm)	178.6 (178.0 – 179.3)	179.1 (178.3 – 180.0)	0.32
Weight (kg)	82.4 (81.3 – 83.4)	82.7 (81.1 – 84.2)	0.73
Body Mass Index (kg/m ²)	25.8 (25.5 – 26.1)	25.7 (25.3 – 26.1)	0.76
Currently smoking (n, %)	78 (15.1%)	37 (15.5%)	0.91

Age is presented as median age with interquartile range. Height, weight and body mass index are presented as estimated means with 95% confidence intervals. Results for weight, height and body mass index were adjusted for age.

Table 2 displays the mean serum levels of various thyroid function parameters in the group of middle-aged offspring of nonagenarian siblings as compared to the group of their middle-aged partners adjusted for age and body mass index. A trend was observed towards higher_serum

thyrotropin levels in the group of offspring when compared to the group of partners ($p=0.11$). The free serum thyroxine levels were lower in the group of offspring than in the group of partners ($p=0.045$). Likewise, mean free serum triiodothyronine levels were lower in the group of offspring in comparison to the group of partners ($p=0.024$). Results were not materially different when analyses were adjusted for smoking behavior.

Table 2. Serum levels of thyroid hormone axis parameters for offspring and partners

	Offspring	Partners	p-value
All			
Thyrotropin (0.3 - 4.8 mU/L)	1.65 (1.59 - 1.71)	1.57 (1.49 - 1.66)	0.11
Free thyroxine (10 - 24 pmol/L)	15.0 (14.9 - 15.2)	15.2 (15.0 - 15.4)	0.045
Free triiodothyronine (2.5 - 5.5 pmol/L)	4.08 (4.04 - 4.12)	4.14 (4.09 - 4.20)	0.024
Ratio triiodothyronine thyroxine	0.28 (0.27 - 0.28)	0.28 (0.27 - 0.28)	0.84
Females			
Thyrotropin (0.3 - 4.8 mU/L)	1.72 (1.63 - 1.80)	1.64 (1.52 - 1.76)	0.28
Free thyroxine (10 - 24 pmol/L)	14.8 (14.6 - 14.9)	15.1 (14.8 - 15.3)	0.034
Free triiodothyronine (2.5 - 5.5 pmol/L)	3.89 (3.84 - 3.94)	4.00 (3.93 - 4.07)	0.007
Ratio triiodothyronine thyroxine	0.27 (0.26 - 0.27)	0.27 (0.26 - 0.27)	0.48
Males			
Thyrotropin (0.3 - 4.8 mU/L)	1.60 (1.52 - 1.69)	1.53 (1.42 - 1.65)	0.26
Free thyroxine (10 - 24 pmol/L)	15.2 (15.0 - 15.4)	15.5 (15.2 - 15.7)	0.12
Free triiodothyronine (2.5 - 5.5 pmol/L)	4.26 (4.20 - 4.31)	4.34 (4.26 - 4.42)	0.048
Ratio triiodothyronine thyroxine	0.28 (0.28 - 0.29)	0.28 (0.28 - 0.29)	0.95

Data are presented as estimated means with 95% confidence intervals. Results for all were adjusted for age, sex and body mass index. Results for males and females separately were adjusted for age and body mass index. Reference values are given between parentheses.

Discussion

The secretion of thyroid hormone from the thyroid gland is regulated by thyrotropin, which in turn is controlled by the hypothalamic derived thyroid-releasing-hormone. The main thyroid hormone produced in the thyroid gland is thyroxine (3,5,3',5'-tetraiodothyronine), which has a low affinity for thyroid hormone receptors in target tissues. Thyroxine can be converted peripherally to the more biologically active free 3,5,3'-triiodothyronine or the inactive reverse

triiodothyronine (3,3',5'-triiodothyronine). When compared to their partners the group of offspring of nonagenarian siblings showed a trend towards higher serum thyrotropin levels in conjunction with lower free thyroxine levels and lower free triiodothyronine levels. These findings indicate a lower thyroidal sensitivity to thyrotropin in the group of offspring of nonagenarian siblings.

In middle aged human populations the effect of low thyroid hormone metabolism on health is unclear. At middle age, overt hypothyroidism is considered a risk factor for the development of atherosclerosis and myocardial infarction^{10, 11}. Paradoxically, in euthyroid middle-aged subjects, lower triiodothyronine serum levels are associated with a beneficial cardio-metabolic profile^{12, 13}. In the current study we demonstrate lower thyroid hormone levels in a middle-aged population which was previously shown to have a lower prevalence of cardiovascular disease¹⁴. These data suggest that selective survival of subjects with a lifelong thyroid hypofunction may contribute to the association between decreased thyroidal sensitivity to thyrotropin and a longer life span^{6, 7}.

Our results agree with observations in several several animal studies showing that lower activity of the thyroid hormone axis is beneficial during the aging process^{1, 3, 15}. Active triiodothyronine primarily regulates the basal metabolic rate of cells, thereby increasing thermogenesis and the production of free radicals¹⁶. Data from model organisms show that low triiodothyronine is associated with lower production of reactive oxygen species (ROS) and ROS inflicted genomic damage¹⁷. The more efficient transport of electrons through the respiratory chain under conditions of low triiodothyronine might reduce the production of ROS and slow aging. Additionally, previous studies in euthyroid subjects have shown an association between higher levels of thyroid hormones and higher serum glucose levels, higher serum insulin levels as well as increased serum triglyceride levels in males^{18, 19}. Furthermore higher triiodothyronine levels have been associated higher blood pressure. Increases in heart rate, cardiac output, myocardial contractility, and blood volume possibly underlie this association between triiodothyronine levels and blood pressure²⁰.

In conclusion, our data demonstrate that the middle-aged offspring of nonagenarian siblings have lower serum free triiodothyronine levels as compared to their middle-aged partners. These findings hint at a role of the thyrotroph axis in the regulation of human health and longevity.

Acknowledgements

This work was supported by the Innovation Oriented research Program on Genomics (SenterNovem; IGE01014 and IGE5007), the Centre for Medical Systems Biology (CMSB), the Netherlands Genomics Initiative/Netherlands Organization for scientific research (NGI/NWO; 05040202 and 050-060-810. NCHA) and the EU funded Network of Excellence Lifespan (FP6 036894). RGJW is supported by an unrestricted grant from the Netherlands Genomics Initiative (NCHA 050-060-810).

Reference List

- (1) Ooka H, Fujita S, Yoshimoto E. Pituitary-thyroid activity and longevity in neonatally thyroxine-treated rats. *Mech Ageing Dev* 1983 June;22(2):113-20.
- (2) Tatar M, Bartke A, Antebi A. The endocrine regulation of aging by insulin-like signals. *Science* 2003 February 28;299(5611):1346-51.
- (3) Brown-Borg HM, Borg KE, Meliska CJ, Bartke A. Dwarf mice and the ageing process. *Nature* 1996 November 7;384(6604):33.
- (4) Vergara M, Smith-Wheelock M, Harper JM, Sigler R, Miller RA. Hormone-treated snell dwarf mice regain fertility but remain long lived and disease resistant. *J Gerontol A Biol Sci Med Sci* 2004 December;59(12):1244-50.
- (5) Buffenstein R. The naked mole-rat: a new long-living model for human aging research. *J Gerontol A Biol Sci Med Sci* 2005 November;60(11):1369-77.
- (6) Atzmon G, Barzilai N, Hollowell JG, Surks MI, Gabriely I. Extreme longevity is associated with increased serum thyrotropin. *J Clin Endocrinol Metab* 2009 April;94(4):1251-4.
- (7) Gussekloo J, van EE, de Craen AJ, Meinders AE, Frolich M, Westendorp RG. Thyroid status, disability and cognitive function, and survival in old age. *JAMA* 2004 December 1;292(21):2591-9.
- (8) Parle JV, Maisonneuve P, Sheppard MC, Boyle P, Franklyn JA. Prediction of all-cause and cardiovascular mortality in elderly people from one low serum thyrotropin result: a 10-year cohort study. *Lancet* 2001 September 15;358(9285):861-5.
- (9) Schoenmaker M, de Craen AJ, de Meijer PH et al. Evidence of genetic enrichment for exceptional survival using a family approach: the Leiden Longevity Study. *Eur J Hum Genet* 2006 January;14(1):79-84.
- (10) Kvetny J, Heldgaard PE, Bladbjerg EM, Gram J. Subclinical hypothyroidism is associated with a low-grade inflammation, increased triglyceride levels and predicts cardiovascular disease in males below 50 years. *Clin Endocrinol (Oxf)* 2004 August;61(2):232-8.

- (11) Walsh JP, Bremner AP, Bulsara MK et al. Subclinical thyroid dysfunction as a risk factor for cardiovascular disease. *Arch Intern Med* 2005 November 28;165(21):2467-72.
- (12) De Pergola G, Ciampolillo A, Paolotti S, Trerotoli P, Giorgino R. Free triiodothyronine and thyroid stimulating hormone are directly associated with waist circumference, independently of insulin resistance, metabolic parameters and blood pressure in overweight and obese women. *Clin Endocrinol (Oxf)* 2007 August;67(2):265-9.
- (13) Ortega E, Koska J, Pannacciulli N, Bunt JC, Krakoff J. Free triiodothyronine plasma concentrations are positively associated with insulin secretion in euthyroid individuals. *Eur J Endocrinol* 2008 February;158(2):217-21.
- (14) Westendorp RG, van Van Heemst D, Rozing MP et al. Nonagenarian Siblings and Their Offspring Display Lower Risk of Mortality and Morbidity than Sporadic Nonagenarians: The Leiden Longevity Study. *J Am Geriatr Soc* 2009 July 21.
- (15) Hauck SJ, Hunter WS, Danilovich N, Kopchick JJ, Bartke A. Reduced levels of thyroid hormones, insulin, and glucose, and lower body core temperature in the growth hormone receptor/binding protein knockout mouse. *Exp Biol Med (Maywood)* 2001 June;226(6):552-8.
- (16) Harper ME, Seifert EL. Thyroid hormone effects on mitochondrial energetics. *Thyroid* 2008 February;18(2):145-56.
- (17) Lopez-Torres M, Romero M, Barja G. Effect of thyroid hormones on mitochondrial oxygen free radical production and DNA oxidative damage in the rat heart. *Mol Cell Endocrinol* 2000 October 25;168(1-2):127-34.
- (18) Bakker SJ, ter Maaten JC, Popp-Snijders C, Heine RJ, Gans RO. Triiodothyronine: a link between the insulin resistance syndrome and blood pressure? *J Hypertens* 1999 December;17(12 Pt 1):1725-30.
- (19) Kim BJ, Kim TY, Koh JM et al. Relationship between serum free T4 (FT4) levels and metabolic syndrome (MS) and its components in healthy euthyroid subjects. *Clin Endocrinol (Oxf)* 2009 January;70(1):152-60.
- (20) Klein I. Thyroid hormone and the cardiovascular system. *Am J Med* 1990 June;88(6):631-7.

Chapter 9: Familial longevity is associated with decreased thyroid function

Maarten P. Rozing^{1,5}, Jeanine J. Houwing-Duistermaat², P. Eline Slagboom^{3,5}, Marian Beekman^{3,5}, Marijke Frölich⁴, Anton J.M. de Craen^{1,5}, Rudi G.J. Westendorp^{1,5}, Diana van Heemst^{1,5}, on behalf of the Leiden Longevity Study (LLS) Group

From the ¹Department of Gerontology and Geriatrics, ²Department of Medical Statistics, ³section Molecular Epidemiology, Department of Medical Statistics, ⁴Department of Clinical Chemistry, Leiden University Medical Center, PO Box 9600, 2300 RC Leiden, The Netherlands, ⁵Netherlands Consortium of Healthy Aging (NCHA)

J Clin Endocrinol Metab. 2010 Nov;95(11):4979-84.



Abstract

A relation between low thyroid activity and prolonged lifespan in humans has been observed. Several studies have demonstrated hereditary and genetic influences on thyroid function. The aim of this study was to test whether low thyroid activity associated with extreme longevity constitutes a heritable phenotype which could contribute to the familial longevity observed in the Leiden Longevity Study. The Leiden Longevity Study comprises 859 nonagenarian siblings (median age 92.9 year) from 421 long-lived families. Families were recruited from the entire Dutch population if at least two long-lived siblings were alive and fulfilled the age-criterion of 89 years or older for males and 91 years or older for females. There were no selection criteria on health or demographic characteristics. In the present study we calculated the Family Mortality History score of the parents of the nonagenarian siblings and related this to thyroid function parameters in the nonagenarian siblings. We found that a lower family history score (less mortality) of the parents of nonagenarian siblings was associated with higher serum thyrotropin levels ($p=0.005$), lower free serum thyroxine levels ($p=0.002$) as well as lower free triiodothyronine levels ($p=0.034$) in the nonagenarian siblings. Our findings support the previous observation that low thyroid activity in humans constitutes a heritable phenotype which contributes to exceptional familial longevity observed in the Leiden Longevity Study.

Introduction

A relation between low thyroid function and prolonged lifespan in elderly humans has been noted^{1, 2}. In the oldest old, higher concentrations of thyrotropin are associated with a survival benefit without detrimental effects on ability or mood. Contrastingly, at old age decreased serum thyrotropin and raised serum free thyroxin levels are related to an increased risk of mortality.³ Hereditary and genetic influences on thyrotropin and serum thyroid hormone concentrations have been reported in multiple studies. The lower thyroid activity associated with extreme longevity might therefore constitute a heritable phenotype⁴⁻⁸.

In order to identify heritable determinants of longevity we designed the Leiden Longevity Study. This study comprises nonagenarian siblings, recruited from families based on proband siblings that both exhibit exceptional longevity⁹. We also included the offspring of the nonagenarian siblings, which are enriched for heritable influences on morbidity and mortality¹⁰. In line with the observed association between low thyroid function and longevity, we showed that the middle-aged offspring of nonagenarian siblings indeed have lower thyroid hormone levels when compared to middle-aged controls¹¹. In the nonagenarian siblings however, comparative analysis of the association between low thyroid function and longevity is hampered by their extreme age, which precludes the use of proper age-matched controls.

To examine the relation between low thyroid function and longevity in the nonagenarian siblings we calculated a family history score describing the mortality of the parents of the nonagenarian siblings¹². We reasoned that in nonagenarian siblings from parents with a lower family history score (i.e. lower than expected mortality), traits related to longevity would be more pronounced than in nonagenarian siblings from parents with a higher family history score. Therefore we hypothesized that lower family history score of the parents of the nonagenarian siblings is related to higher thyrotropin levels and lower serum thyroxine levels in the nonagenarian siblings.

Materials and methods

Leiden Longevity Study

In the Leiden Longevity Study, 421 families were recruited consisting of long-lived Caucasian siblings together with their offspring and the partners thereof. Between 2002 and 2006 families were recruited if at least two long-lived siblings were alive and fulfilled the age-criterion of 89 years or older for males and 91 years or older for females, representing less than 0.5 % of the Dutch population in 2001. There were no selection criteria on health or demographic characteristics. Blood samples were taken at baseline for extraction of DNA, RNA and the determination of non-fasted serum and plasma parameters. Blood samples were obtained

Chapter 9

throughout the day between 9:30 a.m and 17:00 p.m Moreover, data on disability, global cognitive function and self perceived health were collected. The Medical Ethical Committee of the Leiden University Medical Centre approved the study and informed consent was obtained from all subjects. Of the 944 nonagenarians of the Leiden Longevity Study, data on thyrotropin, thyroxine and triiodothyronine levels and sampling time were available for 859 of the nonagenarian participants. Of the 421 families included in this study, 344 (81.7%) families contributed 2 nonagenarian siblings, 67 families have contributed 3 nonagenarian siblings (23.3%), 9 families have contributed 4 nonagenarian siblings (4.2%), 1 family has contributed 5 nonagenarian siblings (0.6%).

Chemical analyses

All serum measurements were performed with fully automated equipment. For thyrotropin, free thyroxine and free triiodothyronine, the Modular E170 was used, for high sensitivity C-reactive protein (hsCRP) the Cobas Integra 800 was used, both from Roche, Almere, the Netherlands. The coefficients of variation of these measurements were all below 5 %. All chemical analyses were performed in a single batch at the Department of Clinical Chemistry, Leiden University Medical Center, the Netherlands, excluding the possibility of confounding by batch effects. In our laboratory, the reference values for thyrotropin were 0.3-4.8 mIU/L; free thyroxine: 10-24 pmol/L; and free triiodothyronine, 2.5-5.5 pmol/L. Of the 859 participants, 746 participants (86.8%) were euthyroid; 5 had overt hyperthyroidism (0.6%); 43 (5.0%) had subclinical hyperthyroidism; 7 (0.8%) had overt hypothyroidism; 58 (6.8%) had subclinical hypothyroidism. Additionally, of the 746 euthyroid subjects, 6 subjects had isolated free thyroxine levels outside the reference values and 14 subjects had isolated free triiodothyronine levels outside the reference values. When analyses were restricted to subjects with thyroid function parameters within the reference range 726 subjects were included (that is: 746 euthyroid subjects minus 6 subjects having abnormal levels of thyroxine and 14 subjects having abnormal levels of triiodothyronine).

Disability

In the Leiden Longevity Study disability was determined using the activities of daily living scale (ADL) and Instrumental Activities of Daily Living scale (IADL)¹³. Disability scores in ADLs range from 0 points (fully dependent in all activities) to 20 points (fully independent in all activities). Disability scores in IADLs range from 0 points (fully dependent in all activities) to 14 points (fully independent in all activities). Global cognitive function was assessed with the Mini Mental State Examination (MMSE). Self perceived health was assessed by one question with five alternatives: 1 = “very good”, 2 = “rather good”, 3 = “moderate”, 4 = “rather poor”, 5 = “very poor”. The MMSE scores range from zero points (very severe cognitive impairment) to 30 points

(optimal cognitive function). ADL, IADL, MMSE and self perceived health was available for 779 participants.

Family History Score

Each participating family has provided us with the genealogical information regarding the parents of the nonagenarian siblings, all siblings, and the offspring of the nonagenarian siblings. To reduce possible unreliability of questionnaires and participants' memories, whenever possible, this information was verified by passport, or by birth or marriage certificate. Furthermore, all data were additionally verified with the personal record cards of the deceased family members in the national population registry located at the Central Bureau of Genealogy in The Hague, The Netherlands. For each parent we computed the sex and birth cohort cumulative hazards using the life tables of the Dutch population. A family history score for a family was defined as two minus the sum of the cumulative hazards of the two parents. Note that since both parents are deceased one minus the cumulative hazard equals the martingale residual. The martingale residual is defined as the difference between the event status (0 if alive, 1 if deceased) and the cumulative hazard at the observed age (current age or age at death). The sum of the martingale residuals measures the deviation of survival of the parents with respect to their birth cohort. Therefore negative values mean excess survival and positive values mean excess mortality.

Statistical analyses

The association between family history score and serum thyroid function parameters was assessed using a linear mixed model with a random sibship effect to model correlation of sibling data. Broad heritability of serum thyroid function parameters was estimated with the following formula: $\text{heritability} = 2 * (\text{between-families variance}) / (\text{between-families variance} + \text{within-families variance})$. Distributions of continuous variables were examined for normality and logarithmically transformed when appropriate (thyrotropin and high sensitivity C-reactive protein). The Statistical Package for the Social Sciences (SPSS) program for Windows, version 14.0, was used for data analysis. Graphs were drawn using Graph Pad Prism version 5.

Results

The principal features of the studied population (n=859) are displayed in **table 1**. The median age of the study population was 92.9 years and 38.4% of the study population was male.

First, we examined the broad heritability of serum thyroid function parameters in the cohort of nonagenarian siblings, as shown in **table 2**. To determine to what extent the association between thyroid function and familial longevity was driven by subjects with thyroid function parameters beyond the normal range, we repeated all the analyses in subjects restricted to thyroid function

parameters within the euthyroid range (model 2). Moreover, it has been demonstrated that alterations in thyroid hormone levels can occur during acute or chronic critical illness. This condition, referred to as non-thyroidal illness syndrome is characterized by a variety of alterations in thyroid function parameters that commonly include low serum triiodothyronine along with normal or inappropriately low thyrotropin and serum free thyroxine levels ¹⁴. To exclude the possibility that physical illness played a major role in our findings, particularly regarding triiodothyronine levels, we repeated the analyses after adjustment for ADLs, IADLs and serum high sensitivity C-reactive protein levels. (model 3). Dependent on the used model, heritability of the serum thyrotropin levels varied between 0.41 and 0.49. Heritability of serum levels of free thyroxine and free triiodothyronine ranged from 0.18 – 0.31 and 0.24 – 0.50 respectively.

Table 1. Baseline characteristics of the study population

	Study population
Number participants	859
Males (n, %)	330 (38.4)
Age (year)	92.9 (91.4 – 94.8)
Thyrotropin (0.3 – 4.8 mU/L)	1.51 (0.95 – 2.40)
Free thyroxine (10 – 24 pmol/L)	16.0 (14.4 – 17.6)
Free triiodothyronine (2.5 – 5.5 pmol/L)	4.00 (3.70 – 4.40)
Hyperthyroidism (n, %)	5 (0.6)
Subclinical hyperthyroidism (n, %)	43 (5.0)
Euthyroidism (n, %)	746 (86.8)
Hypothyroidism (n, %)	7 (0.8)
Subclinical hypothyroidism (n, %)	58 (6.8)
High sensitivity C-reactive protein (<10 mg/L)	2.84 (1.28 – 5.95)
Disability (points)	
ADLs	18 (15 – 20)
Instrumental ADLs	8 (4 - 11)
Mini Mental State Examination	26 (22 - 28)
Self perceived health	3 (3 - 4)

Data are presented as median values with interquartile range (25 – 75%). Reference values are given between parentheses.

Table 2. Broad heritability of thyroid function parameters within the study population

	Broad heritability	p-value
Model 1: adjusted for sex and age.		
Thyrotropin	0.41	<0.001
Free thyroxine	0.18	0.049
Free triiodothyronine	0.24	0.009
Model 2: as model 1, restricted to participants with levels within reference values.		
Thyrotropin	0.49	<0.001
Free thyroxine	0.31	0.007
Free triiodothyronine	0.50	<0.001
Model 3: as model 2 adjusted for ADL, IADL, serum hsCRP levels.		
Thyrotropin	0.46	<0.001
Free thyroxine	0.30	0.012
Free triiodothyronine	0.45	<0.001

Next, we assessed the relation between lower family history score of the parents of the nonagenarian siblings and thyroid hormone function parameters in the nonagenarian siblings. For this purpose we calculated the family history score of the parents of the nonagenarian siblings, as depicted in **figure 1**. A family history score of 0 represents the standardized mortality rate of the entire Dutch population. Values below 0 denote excess survival when compared to the Dutch population, while values above 0 denote relative excess mortality. Median family history score was -1.37 (interquartile range: -2.68 - -0.21), indicating that we have recruited families with a higher average survival than the general Dutch population.

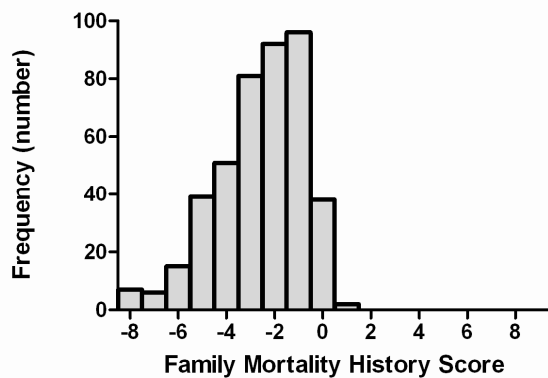

Figure 1. Frequency distribution of family history score of the parents of nonagenarian siblings. A family history score of 0 represents the standardized mortality rate of the entire Dutch population. Values below 0 denote excess survival when compared to the Dutch population, whilst values above 0 denote relative excess mortality.

Table 3 and **figure 2** show the association between family history score and thyroid function parameters. A lower family history score (lower than expected mortality) was associated with higher serum thyrotropin levels, lower free serum thyroxine levels as well as lower free serum triiodothyronine levels. Similar results were obtained after restriction of analyses to participants with thyroid hormone levels within reference values. We repeated the analyses after adjustment for ADLs, IADLs and serum high sensitivity C-reactive protein levels to exclude possible confounding by physical illness (all p values <0.05).

Table 3 Association between family history score and serum thyroid function parameters

	Change per increase familial mortality history unit	p-value
Model 1: adjusted for sex and age.		
Log thyrotropin (mU/L)	-0.05 (-0.09 - -0.004)	0.032
Free thyroxine (pmol/L)	0.16 (0.05 – 0.26)	0.005
Free triiodothyronine (pmol/L)	0.03 (0.002 – 0.06)	0.034
Model 2: as model 1, restricted to participants with levels within reference values.		
Log thyrotropin (mU/L)	-0.04 (-0.06 - -0.01)	0.005
Free thyroxine (pmol/L)	0.13 (0.04 – 0.23)	0.005
Free triiodothyronine (pmol/L)	0.01 (-0.01 – 0.04)	0.23
Model 3: as model 2 adjusted ADL, IADL, serum hsCRP levels..		
Log thyrotropin (mU/L)	-0.04 (-0.06 - -0.01)	0.005
Free thyroxine (pmol/L)	0.15 (0.05 – 0.25)	0.002
Free triiodothyronine (pmol/L)	0.02 (0.002 – 0.05)	0.034

Data are presented as mean change per unit increase in familial mortality history and 95% confidence intervals.

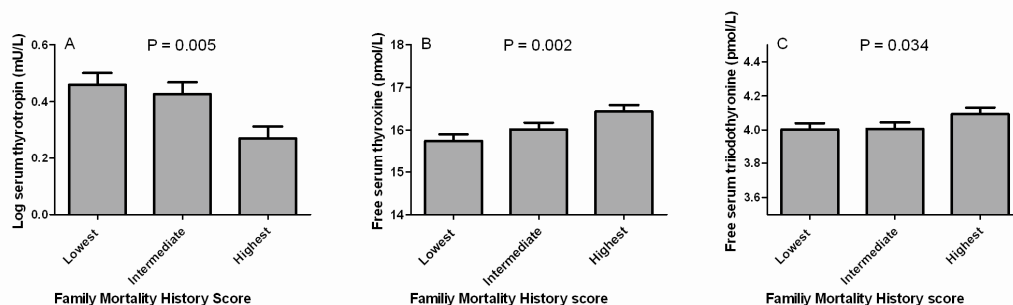

Figure 2A-C. Association between family history score and serum thyroid hormone parameters. For thyrotropin (A), free thyroxine (B) and free triiodothyronine (C). Bars represent tertiles of family history score scores adjusted for age, sex, ADLs, IADLS, and log serum high sensitivity C-reactive protein. Results were restricted to participants with serum thyroid hormone parameters within reference values.

Discussion

We aimed to examine the association between lower thyroid function and longevity in our cohort of nonagenarian siblings. We found that a lower family history score (less mortality) of the parents of nonagenarian siblings was associated with higher serum thyrotropin levels, lower free serum thyroxine levels as well as lower free triiodothyronine levels in the nonagenarian siblings. This observation was not explained by differences in physical disability.

Our findings are an important extension of our previous observation of lower free thyroxine levels and lower free triiodothyronine levels along with a tendency towards higher serum free thyrotropin levels in the middle-aged offspring of nonagenarian siblings when compared to controls ¹¹. Our results not only concur with the reported association between low thyroid hormone function and human longevity¹, but also support the recently reported observation of low thyroid function as a heritable phenotype contributing to exceptional longevity^{2,15}. Moreover, our results are in agreement with earlier studies showing a strong heritability of thyroid function⁶⁻⁸.

The relation between lower family history score of the parents of the nonagenarian siblings and higher thyrotropin along with lower serum thyroxine levels in the nonagenarian siblings may indicate that lower activity of the thyroid hormone axis is a heritable phenotype which contributes to exceptional longevity. Lower activity of the thyroid hormone axis possibly serves as a mechanism to shift energy expenditure from growth and proliferation to protective maintenance. The phenotype of low thyroid hormone levels observed in our long-lived cohort is reminiscent of the phenotype of murine pituitary mutants with delayed aging, as for example the long-lived Ames and Snell dwarf mice^{16, 17}. These model organisms show traits that are hypothesized to be related to thyroid hormone deficiency, and supplementation of thyroid hormone during adulthood partly diminishes their enhanced lifespan.¹⁸ However, unlike our cohort of nonagenarian siblings in which downregulation of the thyroid axis is due to a lower thyroid activity, in these model organisms thyroid hormone deficiency is due to central hypothyroidism at the level of the pituitary.

There are some limitations to our study. First, data on current medication use were not available for the nonagenarian siblings. Furthermore, we have no records of previous history of thyroidal disease, the prevalence of which increases with age. Therefore we could not determine to what extent our observations were affected by thyroid disease and/or its treatment. Thirdly, data on specific SNPs in the thyrotropin receptor which were shown to be associated with higher thyrotropin levels¹⁵, were not available for our cohort. Future research will therefore focus on

unraveling the underlying genetic determinants. Another limitation is that samples were not all drawn fasted at 9:00 a.m. However, additional adjustment for time of blood sampling did not materially change any of the obtained results.

In conclusion our results support the previous observation that low thyroid activity in humans constitutes a heritable phenotype which contributes to exceptional longevity.

Acknowledgements

This work was supported by the Innovation Oriented research Program on Genomics (SenterNovem; IGE01014 and IGE5007), the Centre for Medical Systems Biology (CMSB), the Netherlands Genomics Initiative/Netherlands Organization for scientific research (NGI/NWO; 05040202 and 050-060-810. NCHA) and the EU funded Network of Excellence Lifespan (FP6 036894). RGJW and PES are supported by an unrestricted grant from the Netherlands Genomics Initiative (NCHA 050-060-810). We thank all participants of the Leiden Longevity Study for their consistent cooperation, the secretary staff (Meriam H.G.F. van der Star, Ellen H.M. Bemer-Oorschot) and research nurses (Corrie Groenendijk) for their valuable contribution.

Reference List

- (1) Gussekloo J, van EE, de Craen AJ, Meinders AE, Frolich M, Westendorp RG. Thyroid status, disability and cognitive function, and survival in old age. *JAMA* 2004 December 1;292(21):2591-9.
- (2) Atzmon G, Barzilai N, Hollowell JG, Surks MI, Gabriely I. Extreme longevity is associated with increased serum thyrotropin. *J Clin Endocrinol Metab* 2009 April;94(4):1251-4.
- (3) Parle JV, Maisonneuve P, Sheppard MC, Boyle P, Franklyn JA. Prediction of all-cause and cardiovascular mortality in elderly people from one low serum thyrotropin result: a 10-year cohort study. *Lancet* 2001 September 15;358(9285):861-5.
- (4) Hansen PS, Brix TH, Bennedbaek FN, Bonnema SJ, Kyvik KO, Hegedus L. Genetic and environmental causes of individual differences in thyroid size: a study of healthy Danish twins. *J Clin Endocrinol Metab* 2004 May;89(5):2071-7.
- (5) Hansen PS, van der Deure WM, Peeters RP et al. The impact of a TSH receptor gene polymorphism on thyroid-related phenotypes in a healthy Danish twin population. *Clin Endocrinol (Oxf)* 2007 June;66(6):827-32.
- (6) Nilsson SE, Read S, Berg S, Johansson B. Heritabilities for fifteen routine biochemical values: findings in 215 Swedish twin pairs 82 years of age or older. *Scand J Clin Lab Invest* 2009;69(5):562-9.
- (7) Samollow PB, Perez G, Kammerer CM et al. Genetic and environmental influences on thyroid hormone variation in Mexican Americans. *J Clin Endocrinol Metab* 2004 July;89(7):3276-84.
- (8) Panicker V, Wilson SG, Spector TD et al. Heritability of serum TSH, free T4 and free T3 concentrations: a study of a large UK twin cohort. *Clin Endocrinol (Oxf)* 2008 April;68(4):652-9.
- (9) Schoenmaker M, de Craen AJ, de Meijer PH et al. Evidence of genetic enrichment for exceptional survival using a family approach: the Leiden Longevity Study. *Eur J Hum Genet* 2006 January;14(1):79-84.

Chapter 9

- (10) Westendorp RG, Van Heemst D, Rozing MP et al. Nonagenarian siblings and their offspring display lower risk of mortality and morbidity than sporadic nonagenarians: The Leiden Longevity Study. *J Am Geriatr Soc* 2009 September;57(9):1634-7.
- (11) Rozing MP, Westendorp RG, de Craen AJ et al. Low Serum Free Triiodothyronine Levels Mark Familial Longevity: The Leiden Longevity Study. *J Gerontol A Biol Sci Med Sci* 2009 December 16.
- (12) Houwing-Duistermaat JJ, Callegaro A, Beekman M, Westendorp RG, Slagboom PE, van Houwelingen JC. Weighted statistics for aggregation and linkage analysis of human longevity in selected families: the Leiden Longevity Study. *Stat Med* 2009 January 15;28(1):140-51.
- (13) Bootsma-van der WA, Gussekloo J, de Craen AJ et al. Disability in the oldest old: "can do" or "do do"? *J Am Geriatr Soc* 2001 July;49(7):909-14.
- (14) McIver B, Gorman CA. Euthyroid sick syndrome: an overview. *Thyroid* 1997 February;7(1):125-32.
- (15) Atzmon G, Barzilai N, Surks MI, Gabriely I. Genetic predisposition to elevated serum thyrotropin is associated with exceptional longevity. *J Clin Endocrinol Metab* 2009 December;94(12):4768-75.
- (16) Brown-Borg HM, Borg KE, Meliska CJ, Bartke A. Dwarf mice and the ageing process. *Nature* 1996 November 7;384(6604):33.
- (17) Tatar M, Bartke A, Antebi A. The endocrine regulation of aging by insulin-like signals. *Science* 2003 February 28;299(5611):1346-51.
- (18) Vergara M, Smith-Wheelock M, Harper JM, Sigler R, Miller RA. Hormone-treated snell dwarf mice regain fertility but remain long lived and disease resistant. *J Gerontol A Biol Sci Med Sci* 2004 December;59(12):1244-50.

Chapter 10: Serum triiodothyronine levels and inflammatory cytokine production capacity

Maarten P. Rozing^{1,3}, Rudi G.J. Westendorp^{1,3}, Andrea B. Maier^{1,3}, Carolien A. Wijsman^{1,3}, Marijke Frölich², Anton J.M. de Craen^{1,3}, and Diana van Heemst^{1,3}, on behalf of the Leiden Longevity Study (LLS) Group

From the ¹Department of Gerontology and Geriatrics, Leiden University Medical Center, PO Box 9600, 2300 RC, Leiden, the Netherlands, ²Department of Clinical Chemistry, Leiden University Medical Center, PO Box 9600, 2300 RC, Leiden, the Netherlands, ³Netherlands Consortium of Healthy Aging (NCHA);

Age (Dordr). 2011 Feb 25. Epub ahead of print



Abstract

Increasing evidence suggests that pro-inflammatory cytokines are at play in lowering peripheral thyroid hormone levels during critical illness. Conversely, thyroid hormones have been suggested to enhance production of inflammatory cytokines. In view of these considerations, we hypothesized a mutual association between triiodothyronine and pro-inflammatory cytokines. Therefore we evaluated the relation between both circulating and induced inflammatory markers and serum thyroid function parameters in the Leiden 85-plus Study. We found that higher circulating levels of inflammatory markers were associated with lower levels of free serum triiodothyronine. In turn, higher serum free triiodothyronine levels were related to higher production capacity of pro-inflammatory cytokines after stimulation with lipopolysaccharide. By combining in vivo en ex vivo data we were able to demonstrate for the first time the existence of a potential feedback mechanism between thyroid function and immune production capacity. We conclude that maintenance of normal thyroid function might be important for a preserved immune response in elderly human populations.

Introduction

During critical illness, major changes in serum thyroid hormone metabolism without primary involvement of the thyroid gland can occur^{1,2}. This altered thyroid metabolism, referred to as non-thyroidal illness syndrome, is characterized by low serum levels of triiodothyronine and thyroxine, without changes in thyrotropin levels. Although the pathogenesis of non-thyroidal illness syndrome remains poorly understood, the reduction of peripheral thyroid levels is most probably under the influence of pro-inflammatory cytokines, and interleukin-6 in particular³⁻⁵.

Conversely, it has been suggested that thyroid hormones induce production of inflammatory cytokines. Earlier studies have demonstrated higher circulating levels of pro-inflammatory cytokines in patients with hyperthyroidism^{6,7}. These elevated cytokine levels were independent of autoimmune inflammation usually associated with thyroid disease. Moreover, treatment of hyperthyroidism was associated with lowering of serum pro-inflammatory cytokine levels.⁸

In view of these considerations, we postulated a mutual association between triiodothyronine and pro-inflammatory cytokines, in which serum free triiodothyronine has a stimulatory effect on the pro-inflammatory cytokine production capacity, whilst pro-inflammatory cytokines in turn temper this stimulatory effect of triiodothyronine by lowering peripheral thyroid hormone levels. To test this hypothesis we first assessed the relation between various circulating inflammatory markers and serum thyroid function parameters in the Leiden 85-plus Study, a prospective population based study among the oldest old. Next, we assessed the relation between serum thyroid function parameters and ex vivo cytokine production capacity. Physical illness was considered a potential confounder in the relation between serum thyroid function parameters and cytokine production capacity.

Materials and methods

The Leiden 85-plus Study

We obtained data from the prospective population-based Leiden 85-plus Study involving 85-year old inhabitants of the city of Leiden, the Netherlands. A total of 599 subjects (397 women and 202 men) participated (with a response rate of 87%). No selection criteria had been imposed for health status or demographic characteristics. A cytokine production capacity assay was performed for 555 subjects. For the present study subjects using thyroid medication were excluded from analyses (n = 21) as were participants with incomplete thyroid function parameters (n=22). For further details on enrollment we refer to previous publications.^{9,10} The Medical Ethical Committee of the Leiden University Medical Centre approved the study and informed consent was obtained from all subjects.

Biochemical analyses

All serum measurements were performed with fully automated equipment. For thyrotropin (TSH), free thyroxine (fT4) and free triiodothyronine (fT3), the Modular E170 was used and for C-reactive protein (CRP), the Hitachi Modular or the Cobas Integra 800, both from Roche, Almere, the Netherlands were applied. Coefficients of variation (CV) of these measurements were below 5 %. In our laboratory, the reference values for thyrotropin were 0.3-4.8 mIU/L; free thyroxine: 13-23 pmol/L; and free triiodothyronine: 2.5-5.5 pmol/L.

The production capacity of cytokines (ng/mL) was assessed by measuring the cytokine production capacity of whole blood samples upon ex vivo stimulation with lipopolysaccharide (LPS) as described elsewhere.¹¹ In short, cytokine production peak levels were assessed with an ex vivo whole-blood assay. All venous blood samples were taken in the morning before 11.00 a.m to preclude circadian variation. The blood was collected in heparinized tubes and samples were diluted two-fold with RPMI-1640 (Sigma, St. Louis, MO) and stored after addition of 10 pg/ml *E. coli*-derived LPS (Difco Laboratories, Detroit) at 37 °C and 5% CO₂ for 24 hours. After centrifugation, the supernatants were stored at -80 °C until assayed using standard ELISA techniques (Central Laboratory of the Blood Transfusion Service, Amsterdam, The Netherlands). The CV for the cytokine assays, influenced also by dilutions for high stimulated values, were below 6% for IL-1 β and IL-10; below 8 % for TNF- α and IL-6; whereas IL-1 RA ranged up to 12 %.

Data on circulating interleukin-6 levels were not available for our study population. Therefore, we used the IL-6 levels in unstimulated whole blood as a surrogate measure for circulating IL-6 levels.¹²

Health status

We considered physical illness a potential confounder in the relation between serum thyroid function parameters and cytokine production capacity. Indication of baseline health status was obtained by assessing plasma levels of C-reactive protein, Activities of Daily Living scores, Instrumental Activities of Daily Living scores and Mini Mental State Examination. Disability scores in ADLs and in IADLs range from 9 points, indicating complete independence in all activities, to 36 points indicating complete dependence in all activities. The MMSE scores range from zero points, indicating very severe cognitive impairment, to 30 points indicating optimal cognitive functioning.

Statistical analyses

The association between serum inflammatory markers and thyroid function parameters was tested using a linear regression model adjusted for sex. For the association between thyroid axis parameters and cytokine production capacity we used a linear regression model adjusted for sex only and additionally adjusted for ADLs, IADLs, MMSE and CRP to take into account potential confounding by physical illness. Distributions of continuous variables were examined for normality and logarithmically transformed, when appropriate (Thyrotropin, CRP, unstimulated IL-6, and stimulated levels of IL-1 β , IL-6, TNF- α , IL-1RA, and IL-10). The Statistical Package for the Social Sciences (SPSS) program for Windows, version 16.0 was used for data analysis. Sixteen subjects had serum thyroid parameters beyond three standard deviations from the geometric mean and were considered outliers. All but two of the sixteen outliers were euthyroid.

Results

The baseline characteristics of the 496 participants in the study are presented in **table 1**. All study participants were 85 years of age and 327 out of 496 participants (65.9%) were female.

Table 2 shows the association between various serum inflammatory markers and different thyroid parameters. Neither CRP nor interleukin 6 were associated with serum thyrotropin or free thyroxine levels. Higher levels of circulating C-reactive protein were significantly related to lower serum levels of free triiodothyronine ($p = 0.001$). Likewise, higher levels of interleukin-6 were associated with lower levels of triiodothyronine ($p = 0.020$). We repeated the analyses after excluding persons who on the basis of their CRP levels (higher than 10.0 mg/dL) may be experiencing an acute infection ($n=75$). Although after exclusion of subjects with CRP levels above 10 mg/dL the associations between free triiodothyronine levels and CRP and between free triiodothyronine levels and IL6 lost statistical significance, the effect sizes remained roughly similar, indicating that the observed associations are not completely driven by those with exceptionally high hsCRP.

Next, we assessed the association between different thyroid function parameters and whole blood LPS-stimulated cytokine production capacity. The outcomes are given in **Table 3**. Serum thyrotropin levels and serum free thyroxine levels were not associated with cytokine production capacity. However, higher levels of serum free triiodothyronine concentrations were consistently associated with a higher production of pro-inflammatory cytokines (IL-1 β , IL-6, TNF- α) after whole blood stimulation with LPS. The relation between triiodothyronine levels and the pro-inflammatory cytokines (IL-1 β , IL-6, TNF- α) is also illustrated in **figure 1**.

Table 1. Baseline characteristics of the study population.

	Study Population
	N = 496
Demographics	
Age (year)	85
Females (N, %)	327 (65.9 %)
MMSE (points)	26 (22 – 28)
ADLs (points)	10 (9 – 15)
Instrumental ADLs (points)	18 (12 - 26)
Serum parameters	
Thyrotropin – mU/L	1.81 (1.20 – 2.74)
Free thyroxine – pmol/L	14.3 (12.7 – 15.7)
Free triiodothyronine – pmol/L	3.41 (3.08 – 3.74)
C-reactive protein (mg/L)	4.0 (1.0 – 8.0)
Unstimulated IL-6 (ng/L)*	11.0 (1.0 – 50.5)
LPS- induced cytokine production	
IL-1 β (ng/L)	3517 (2099 – 6502)
IL-6 (ng/L)	60750 (43406 - 84733)
TNF- α (ng/L)	10325 (7393 – 13418)
IL-1RA (ng/L)	37297 (28369 – 46016)
IL-10 (ng/L)	764 (490 - 1089)

D

ata are given as median value with interquartile range, unless stated otherwise.

* IL-6 levels in unstimulated whole blood were used as a surrogate measure for circulating IL-6 levels. LPS: lipopolysaccharide.

Table 2. Association between serum inflammatory markers and thyroid function parameters

	Change per standard deviation increase	
	All subjects	Restricted to CRP levels ≤10 (mg/dL)
Ln C-Reactive protein		
In thyrotropin (mU/L)	0.02 (0.03)	0.04 (0.05)
<i>p-value</i>	0.57	0.32
Free thyroxine (pmol/L)	0.07 (0.10)	-0.09 (0.13)
<i>p-value</i>	0.47	0.52
Free triiodothyronine (pmol/L)	-0.07 (0.02)	-0.05 (0.03)
<i>p-value</i>	0.001	0.09
Ln unstimulated IL-6		
In thyrotropin (mU/L)	0.02 (0.03)	0.03 (0.04)
<i>p-value</i>	0.57	0.40
Free thyroxine (pmol/L)	0.05 (0.10)	0.01 (0.11)
<i>p-value</i>	0.59	0.92
Free triiodothyronine (pmol/L)	-0.05 (0.02)	-0.03 (0.02)
<i>p-value</i>	0.020	0.25

Data are given as mean change (with standard error of the mean) in serum thyroid parameter per standard deviation increase in Ln C-Reactive protein and Ln unstimulated IL-6. Analyses were adjusted for sex. LPS: lipopolysaccharide.

We considered physical illness as a potential confounder of the relation between triiodothyronine levels and cytokine production capacity. Therefore we repeated the analyses after inclusion of parameters of physical disability: activities of daily living score (ADLs), instrumental activities of daily living score (IADLs), Mini Mental State Examination (MMSE) and serum C-reactive protein (CRP). As apparent from **table 4**, correction for these parameters did not substantially affect our results. Also exclusion of subjects with hsCRP levels higher than 10.0 mg/L (n=75) from the analyses did not materially affect the observed associations between thyroid function parameters and whole blood LPS-stimulated cytokine production (data not shown): lower free triiodothyronine levels were associated with lower production capacity of pro-inflammatory cytokines after stimulation with LPS (all *p* values <0.006). No relation was observed between levels of serum thyrotropin and serum free thyroxine and cytokine production capacity.

Table 3. Association between thyroid function parameters and whole blood LPS-stimulated cytokine production

LPS -stimulated cytokine levels	Change per standard deviation increase		
	ln Thyrotropin (mU/L)	Free thyroxine (pmol/L)	Free triiodothyronine (pmol/L)
ln IL-1 β (ng/ml)	-0.06 (0.06)	0.02 (0.05)	0.13 (0.04)
<i>p</i> -value	0.25	0.61	0.002
ln IL-6 (ng/ml)	-0.02 (0.04)	0.00 (0.03)	0.10 (0.03)
<i>p</i> -value	0.56	0.99	<0.001
ln TNF- α (ng/ml)	-0.02 (0.03)	0.01 (0.03)	0.09 (0.02)
<i>p</i> -value	0.45	0.63	<0.001
ln IL1 β RA (ng/ml)	0.01 (0.03)	0.02 (0.03)	0.02 (0.02)
<i>p</i> -value	0.96	0.36	0.39
ln IL-10 (ng/ml)	-0.03 (0.05)	-0.03 (0.04)	0.07 (0.04)
<i>p</i> -value	0.47	0.49	0.052

Data are given as mean change (with standard error of the mean) in LPS stimulated cytokine level per standard deviation increase in serum thyroid parameter. All analyses were adjusted for sex. LPS: lipopolysaccharide.

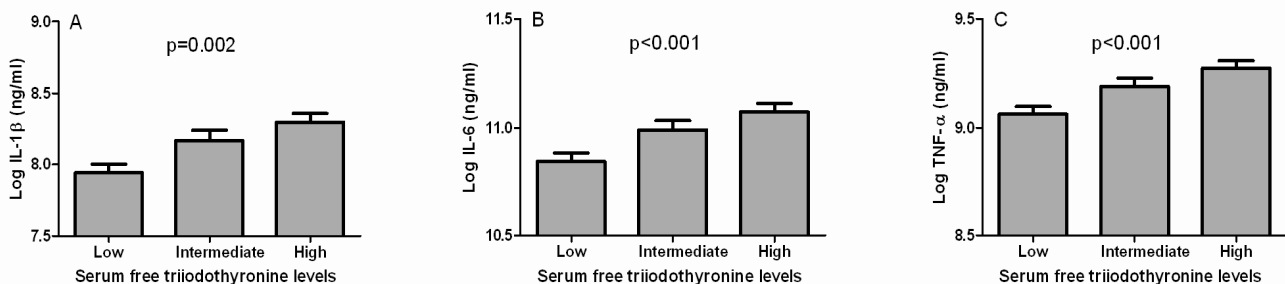

Figure 1. Relation between tertiles of serum free triiodothyronine levels and pro-inflammatory cytokine production capacity for A: Log IL-1 β ; B: Log IL-6; C: Log TNF- α . Results were adjusted for sex.

Table 4. Association between thyroid axis parameters and whole blood LPS-stimulated

LPS -stimulated cytokine levels	Change per standard deviation increase		
	ln Thyrotropin (mU/L)	Free thyroxine (pmol/L)	Free triiodothyronine (pmol/L)
ln IL-1 β (ng/ml)	-0.06 (0.05)	0.03 (0.05)	0.09 (0.04)
<i>p-value</i>	0.24	0.47	0.047
ln IL-6 (ng/ml)	-0.02 (0.03)	0.01 (0.03)	0.06 (0.03)
<i>p-value</i>	0.48	0.82	0.017
ln TNF- α (ng/ml)	-0.03 (0.03)	0.02 (0.03)	0.07 (0.03)
<i>p-value</i>	0.37	0.46	0.006
ln IL1 β RA (ng/ml)	0.00 (0.03)	0.02 (0.03)	0.01 (0.02)
<i>p-value</i>	0.99	0.35	0.58
ln IL-10 (ng/ml)	-0.03 (0.05)	-0.02 (0.04)	0.03 (0.04)
<i>p-value</i>	0.51	0.60	0.41

cytokine production in subjects aged 85

Data are given as mean change (with standard error of the mean) in LPS stimulated cytokine level per standard deviation increase in serum thyroid parameter. All analyses were adjusted for sex, ADLs, instrumental ADLs, MMSE and log serum CRP levels. LPS: lipopolysaccharide.

Discussion

The purpose of this study was to investigate a mutual association between triiodothyronine and pro-inflammatory cytokines. Here, we show that higher circulating levels of inflammatory markers were associated with lower levels of free serum triiodothyronine. In turn, lower free triiodothyronine levels were related to lower production capacity of pro-inflammatory cytokines after stimulation with LPS. We did not observe such a relation for levels of serum thyrotropin and serum free thyroxine. Our findings were independent of measures of physical and cognitive impairment.

The observed association between higher unstimulated interleukin-6 levels and lower free serum triiodothyronine in our study agrees with earlier reports which show an association between increased inflammatory cytokines and low triiodothyronine syndrome^{3,4}. Moreover, other studies have demonstrated higher circulating levels of pro-inflammatory cytokines in patients with hyperthyroidism, suggesting a stimulatory effect of thyroid hormones on inflammatory cytokine production⁸. However, to our knowledge this is the first study to address a direct relation

between serum thyroid hormone levels and inflammatory cytokine production capacity in blood cells.

Our findings support the hypothesis of a mutual association between triiodothyronine and pro-inflammatory cytokines. As depicted schematically in **figure 2**, in this proposed feedback system, serum free triiodothyronine stimulates the pro-inflammatory cytokine production capacity, while pro-inflammatory cytokines in turn blunt the stimulatory effect of triiodothyronine by lowering peripheral thyroid hormone levels. Lowering of peripheral triiodothyronine levels under the influence of cytokines possibly occurs through regulation of peripheral deiodinase activity, although this putative mechanism has been disputed. The stimulatory effect of triiodothyronine on the cytokine production capacity is likely mediated via nuclear receptors regulating genes involved in the cell-mediated immune response. In humans high affinity nuclear thyroid hormone receptors have been identified in mononuclear cells ^{13;14}. Although these observations provide a tentative explanation for the mutual association between thyroid hormones and cytokines, the epidemiological nature of our study does not allow us to identify the exact underlying mechanisms.

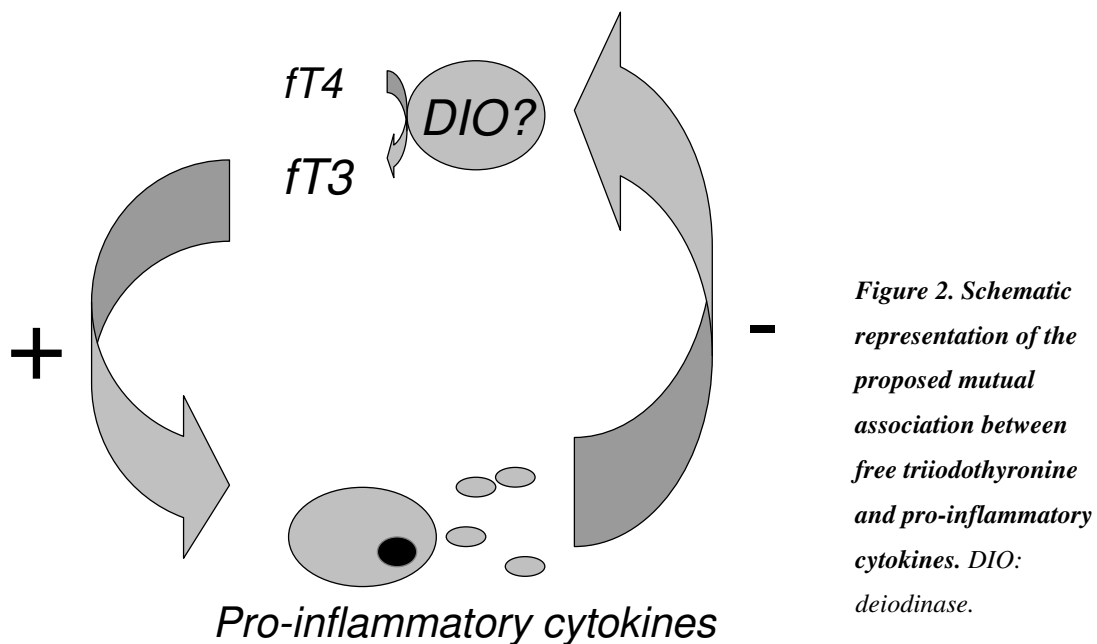

Figure 2. Schematic representation of the proposed mutual association between free triiodothyronine and pro-inflammatory cytokines. DIO: deiodinase.

Another possible limitation of our investigation is the advanced age of our study population. We have however no reason to assume that our findings do not apply to younger age categories. Moreover, the fact that the prevalence of thyroid disorders increases with age ¹⁵, makes our observations done in a population of the oldest old all the more clinically relevant. The age-related increase in the prevalence of thyroid disorders might be involved in changes in immune

function with age. Maintenance of normal thyroid function could therefore contribute to a preserved immune response in elderly human populations.

Our study has several strong points, particularly the large size of the study population and the variety of studied inflammatory markers, comprising both pro- as well as anti-inflammatory markers. In addition, our study is unique in that we were able to combine both in vivo and ex vivo information on our study population. Finally, the current study has been done in the general population composed of healthy to moderately healthy subjects, in contrast to most previous studies on the relation between thyroid hormones and immune response which have been done in clinical settings.

In summary, by combining in vivo and ex vivo data we are the first to demonstrate a potential feedback mechanism between thyroid function and immune production capacity. These observations suggest that maintenance of normal thyroid function contributes to a preserved immune response in elderly human populations. Therefore our findings could have important implications in the care for a growing elderly population.

Acknowledgements

The Leiden 85-plus Study was in part supported by an unrestricted grant from the Dutch Ministry of Health, Welfare and Sports. This current study was funded by the Netherlands Genomics Initiative/Netherlands Organization for scientific research (NGI/NWO; 05040202 and 050-060-810. NCHA) and the EU funded Network of Excellence Lifespan (FP6 036894). We thank Margo van Schie-Troost and Marja Kersbergen-van Oostrom for their work on the cytokine assays.

Reference List

- (1) Wartofsky L, Burman KD. Alterations in thyroid function in patients with systemic illness: the "euthyroid sick syndrome". *Endocr Rev* 1982;3:164-217.
- (2) Chopra IJ, Hershman JM, Pardridge WM, Nicoloff JT. Thyroid function in nonthyroidal illnesses. *Ann Intern Med* 1983;98:946-957.
- (3) Davies PH, Black EG, Sheppard MC, Franklyn JA. Relation between serum interleukin-6 and thyroid hormone concentrations in 270 hospital in-patients with non-thyroidal illness. *Clin Endocrinol (Oxf)* 1996;44:199-205.
- (4) Boelen A, Maas MA, Lowik CW, Platvoet MC, Wiersinga WM. Induced illness in interleukin-6 (IL-6) knock-out mice: a causal role of IL-6 in the development of the low 3,5,3'-triiodothyronine syndrome. *Endocrinology* 1996;137:5250-5254.
- (5) Papanicolaou DA. Euthyroid Sick Syndrome and the role of cytokines. *Rev Endocr Metab Disord* 2000;1:43-48.
- (6) Lakatos P, Foldes J, Horvath C et al. Serum interleukin-6 and bone metabolism in patients with thyroid function disorders. *J Clin Endocrinol Metab* 1997;82:78-81.
- (7) Siddiqi A, Burrin JM, Wood DF, Monson JP. Tri-iodothyronine regulates the production of interleukin-6 and interleukin-8 in human bone marrow stromal and osteoblast-like cells. *J Endocrinol* 1998;157:453-461.
- (8) Siddiqi A, Monson JP, Wood DF, Besser GM, Burrin JM. Serum cytokines in thyrotoxicosis. *J Clin Endocrinol Metab* 1999;84:435-439.
- (9) van den Biggelaar AH, Huizinga TW, de Craen AJ et al. Impaired innate immunity predicts frailty in old age. The Leiden 85-plus study. *Exp Gerontol* 2004;39:1407-1414.
- (10) Taekema DG, Westendorp RG, Frolich M, Gussekloo J. High innate production capacity of tumor necrosis factor-alpha and decline of handgrip strength in old age. *Mech Ageing Dev* 2007;128:517-521.
- (11) van der Linden MW, Huizinga TW, Stoeken DJ, Sturk A, Westendorp RG. Determination of tumour necrosis factor-alpha and interleukin-10 production in a whole

Chapter 10

- blood stimulation system: assessment of laboratory error and individual variation. *J Immunol Methods* 1998;218:63-71.
- (12) Schram MT, Euser SM, de Craen AJ et al. Systemic markers of inflammation and cognitive decline in old age. *J Am Geriatr Soc* 2007;55:708-716.
- (13) Buergi U, Larsen PR. Nuclear triiodothyronine binding in mononuclear leukocytes in normal subjects and obese patients before and after fasting. *J Clin Endocrinol Metab* 1982;54:1199-1205.
- (14) Burman KD, Latham KR, Djuh YY et al. Solubilized nuclear thyroid hormone receptors in circulating human mononuclear cells. *J Clin Endocrinol Metab* 1980;51:106-116.
- (15) Mariotti S, Franceschi C, Cossarizza A, Pinchera A. The aging thyroid. *Endocr Rev* 1995;16:686-715.

Chapter 11: General discussion and synopsis of part A

Maarten P. Rozing^{1,3}, Rudi G.J. Westendorp^{1,3}, P. Eline Slagboom^{2,3}, and Diana van Heemst^{1,3},
on behalf of the Leiden Longevity Study (LLS) Group

From the ¹Department of Gerontology and Geriatrics, Leiden University Medical Center, PO Box 9600, 2300 RC, Leiden, the Netherlands; ²Department of Medical Statistics, Molecular Epidemiology, Leiden University Medical Center, PO Box 9600, 2300 RC Leiden, The Netherlands, ³Netherlands Consortium of Healthy Aging (NCHA).

Part of this chapter has been published in J Gerontol A Biol Sci Med Sci. 2010 Nov;65(11):1252-3.



Introduction

World life expectancy has rapidly increased over the last two centuries, however not all of the gained years of life are spent in good health. There is a strong need to identify candidate targets for interventions to prevent age-related loss of function and morbidity. Substantial evidence supports the familial clustering of exceptional longevity, suggesting a genetic etiology for longevity. In search for the biology of healthy longevity we therefore set off to study the phenotypes of exceptionally long-lived families in the Leiden Longevity Study. In this chapter, we give a summary of the endocrine and metabolic characteristics that appear to be pertinent for familial healthy longevity.

Mortality and morbidity

Previous studies have shown that familial factors contribute substantially to the ability to reach very old age ¹. Indeed, families from the Leiden Longevity Study display a striking survival benefit of 30% when compared to the general population (**chapter 2**). This lower mortality risk is not only present in nonagenarian sibling pairs but extends to first-degree family members of the nonagenarian siblings as well ^{2,3}. Persistence of a survival advantage in siblings up to the highest age ranges suggests the involvement of genetic factors since many environmental factors shared early in life are likely to diverge as the siblings grow older ⁴.

Apart from a delay in mortality, another important indicator of aging retardation is a later onset of age-related diseases ⁵. The incidence of diseases declines with age and is an important contributor to mortality ⁶. We found that the offspring of nonagenarian siblings had a markedly reduced risk for age-related diseases as myocardial infarctions, hypertension and most notably type II diabetes (**chapter 2**) ². Our outcomes are in accordance with prior studies which showed lower disease prevalence in children from parents who reached an exceptionally high age when compared to control subjects whose parents died at younger ages ^{7,8}. However in these earlier studies significant differences in major cardiovascular risk factors were present between these groups, including years of education and smoking habits. Exact determination of the contribution of genetic, behavioural, and lifestyle factors therefore remained cumbersome. Moreover, since centenarians generally engage in healthy lifestyles, their offspring may have copied their behaviour ⁹. To rule out potential confounding by differences in environmental factors, we compared offspring from long-lived cases with their partners in the Leiden Longevity Study. We hypothesized that as the offspring and their partners by and large share the same environment, it is unlikely that any observed differences between the two groups are due to differences in environmental factors. Indeed, major indicators of lifestyle, including estimates for BMI, current smoking, and associated prevalence of chronic obstructive pulmonary disease were similar

between both groups, indicating that the difference in health status is more likely due to genetic than environmental factors ^{2,10}.

We did not find a difference in cancer prevalence nor deaths due to cancer when comparing offspring with controls. This finding is at odds with earlier research showing a relative lower risk of cancer mortality in offspring of centenarians as compared to controls ¹¹. The discrepancy might be explained by a difference in age: the study groups from the Leiden Longevity Study are approximately 10 years younger than those in the reported study.

IGF insulin signaling

The role of the evolutionarily conserved insulin/ insulin-like growth factor (IGF-1) signaling (IIS) pathway in the regulation of lifespan is well documented in worms ¹², flies ¹³, and rodents ^{14;15}. Genetic mutations that partially blunt IIS activation prolong lifespan in these organisms, particularly in the female sex. Invertebrates have a single receptor that binds multiple ligands comparable to insulin/IGF-1, whereas in mammals distinct receptors have evolved for insulin and IGF-1, with different but overlapping functions. IGF-1 is involved in growth, while insulin primarily regulates metabolism ¹⁶.

In mammals, a hallmark phenotype shared by many of the long-lived mutants ¹⁷ including those with genetically induced IGF-1 resistance is their preserved insulin sensitivity and low fasting blood glucose levels. Preserved insulin sensitivity is also closely linked to the lower mortality observed in mammals under dietary restriction conditions. Several findings in the Leiden Longevity Study imply that preserved insulin sensitivity is at play in human longevity as well.

First, the middle-aged offspring of nonagenarian siblings had relatively lower blood glucose and insulin levels (**chapter 7**) ¹⁸ as well as a more favourable glucose tolerance as assessed by oral glucose tolerance tests (**chapter 3**) ¹⁰. Preliminary evidence suggests that this phenotype of lower blood glucose and insulin levels in families with exceptional longevity relative to the general population is present even up to the highest age ranges (**figure 1**). Remarkably, common determinants for insulin resistance such as physical activity, body composition, diet, low-grade inflammation (**chapter 5**) were similar between the middle-aged groups. Secondly, the group of offspring showed a lower prevalence of metabolic syndrome (**chapter 3**) ¹⁰, a combination of cardio-vascular risk factors for which the dominant underlying factor appears to be insulin resistance. When considering the individual components of the metabolic syndrome, the group of offspring contained fewer individuals with low HDL levels and a lower number of individuals with impaired fasting glucose. Obesity related criteria, including elevated waist circumference

and fasting triglyceride levels were equal between the two groups, centralizing the role of glucose metabolism in our findings. Finally, middle-aged offspring predisposed for healthy longevity showed higher whole-body insulin sensitivity, marked by enhanced peripheral glucose disposal as assessed by hyperinsulinaemic euglycaemic clamp (**chapter 4**). Using this technique, which is considered the gold standard for assessment of whole-body insulin sensitivity, we found that it is insulin action on glucose metabolism, and glucose disposal in particular, that distinguishes offspring of long-lived siblings from controls, rather than insulin mediated suppression of endogenous glucose production or lipolysis. The importance of sustained insulin action on glucose disposal is in agreement with prior studies on the pathophysiology of type II diabetes mellitus. Peripheral insulin resistance is regarded as one of the earliest steps in the pathophysiology of diabetes^{19;20}, and is already present several decades before onset of the disease^{21;22}. Insufficient suppression of hepatic glucose production, on the other hand, is a consequence of fat accumulation in the liver²³, and is considered an advanced phenomenon in the trajectory towards onset of diabetes²⁰.

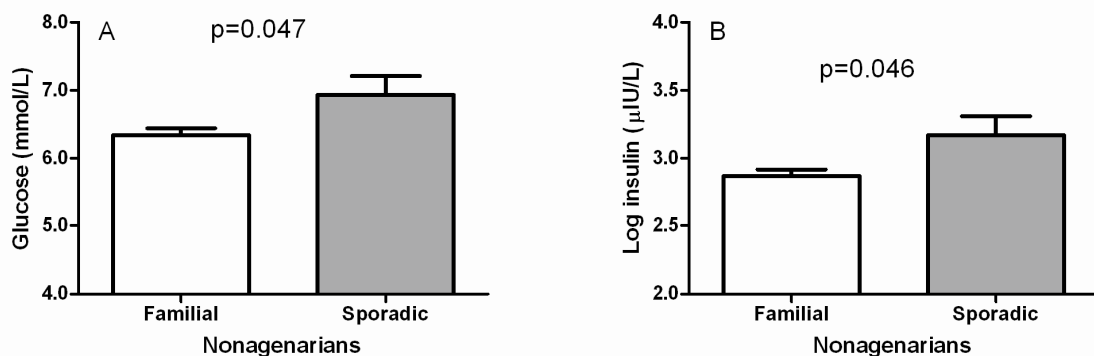

Figure 1. Non-fasted serum glucose (A) and log insulin (B) levels for familial nonagenarians (N=333) and sporadic nonagenarians (N=49) (not selected for having nonagenarian siblings). To decrease the possible influence of differences in health status between the two groups, nonagenarians from the highest tertile of performance on Instrumental Activities of Daily Living score were included. Bars represent mean levels with standard errors of the mean adjusted for sex and age.

Our data agree with earlier studies which show that the offspring of exceptionally long-lived individuals are protected against development of cardio-vascular disease^{11;24;25}. Earlier, offspring from long-lived parents were shown to have favorable lipid profiles^{26;27}. However, while it was shown that offspring of exceptionally long-lived individuals are healthier in many respects²⁸, this has not been reported before for glucose regulation. While insulin sensitivity generally declines with age in humans, sporadic long-lived centenarians exhibit an extraordinary insulin sensitivity, comparable to that of young adults²⁹. Our findings add to these previous observations by

demonstrating that a beneficial glucose metabolism is already present at middle-age in offspring of familial nonagenarians.

Apart from the preserved insulin sensitivity, exceptional human longevity is possibly associated with tempering of the IGF-1 signaling pathway. Recently, it was shown that centenarians exhibited a relative enrichment for rare genetic variants in the IGF-1 receptor which resulted in high levels of IGF-1/IGFBP3 coexisting with low levels of IGF-1 signaling³⁰. We and others demonstrated that common genetic variations affecting IGF-1 signaling might contribute to differences in mortality in the general population^{30;31}. In line with these studies and other studies in model organisms, we found preliminary evidence for the involvement of reduced IGF-1 signaling in familial longevity. Most recently, we observed lower serum levels of IGF-1 in female nonagenarians whose parents reached an exceptionally high age when compared to nonagenarian subjects whose parents died at younger ages (**chapter 8**). Another important feature of (lifelong) blunted IGF-signalling in both humans and model organism is a relatively small stature. In agreement with this observation, nonagenarians from parents who reached an exceptionally high age tended to be shorter than nonagenarian subjects whose parents died younger.

The findings in the group nonagenarians contrast with those in their middle-aged children. We did not observe differences in IGF-1 serum levels nor height between the offspring and their partners (**chapter 7**)¹⁸. Moreover a single time-point measurement after overnight fast showed similar levels of serum growth hormone levels between the two generations (**table 1**). These disparate results may be explained by differences in age. The estimated contribution of genetic factors to longevity is modest (20-30%) but was shown to become more important and specific at higher ages. Therefore it is possible that the effects of genetic variation in the IIS pathway only become detectable at advanced ages. In line, the association between genetic variation in *FOXO3A* and longevity was found to be stronger in centenarians than in nonagenarians³². Another possible explanation for these contrasting observations could be differences in imprinting of the IGF-1 gene, reflecting historical differences in maternal nutrition between the two generations^{30;33}.

Thyroid function

The hypothalamo–pituitary–thyroid axis is widely implicated in modulating the aging process³⁴. Life prolonging effects related to decreased thyroid hormone levels have been reported in multiple animal models. In neonatal rats induction of hypothyroidism results in a moderate extension of lifespan³⁵. Similarly, low thyroid hormone levels are characteristic of murine pituitary mutants with postponed aging: long-lived Ames and Snell dwarf mice show features that are likely related to thyroid hormone deficiency³⁶. In humans a relation between low thyroid

function and extended lifespan has been observed as well. In the oldest old, higher concentrations of thyrotropin are associated with a survival advantage without apparent detrimental effects on ability or mood ^{37;38}.

Table 1. Serum levels of endocrine parameters under fasted conditions for offspring and partners

	Offspring	Partners	P-value
Participants (N)	121	113	
Females (N, %)	62 (51.2%)	59 (48.8%)	0.90
TSH (mU/L)	2.41 (1.93 - 3.06)	1.69 (1.33 - 2.15)	0.029
free T4(pmol/L)	16.2 (15.8 - 16.6)	16.4 (16.0 - 16.9)	0.49
free T3 (pmol/L)	5.03 (4.87 - 5.20)	5.26 (5.09 - 5.44)	0.045
Growth hormone (mU/L)	1.90 (1.50 - 2.40)	2.02 (1.58 - 2.57)	0.72
IGF-1 (nmol/L)	15.3 (14.3 - 16.2)	15.0 (14.1 - 16.0)	0.71
IGFBP3 (mg/L)	4.03 (3.85 - 4.21)	3.98 (3.79 - 4.16)	0.63
Cortisol (µmol/L)	0.49 (0.47 - 0.52)	0.52 (0.49 - 0.55)	0.22
Prolactin (U/L)	10.1 (9.28 - 10.9)	10.3 (9.51 - 11.2)	0.64
HsCRP (mg/dL)	1.29 (1.17 - 1.60)	1.17 (0.93 - 1.46)	0.45

Data are given as mean values with 95% confidence intervals. TSH, growth hormone and high-sensitivity C-reactive protein (hsCRP) are given as geometric means with 95% confidence intervals. Samples were taken between 9:00 - 9:30 a.m. data were adjusted for sex and age.

The outcomes of the Leiden Longevity Study seem to support the relation between low thyroid function and extended life span. Nonagenarians from parents who reached an exceptionally high age had higher thyrotropin levels, lower free thyroxine and lower free triiodothyronine levels when compared to nonagenarian subjects whose parents died at younger ages (**chapter 9**) ³⁹. The lower thyroid function in the nonagenarians was reflected in their middle-aged children, who showed lower peripheral thyroid hormone levels and a tendency towards elevated thyrotropin levels as compared to their partners during both non-fasted (**chapter 8**) ⁴⁰ and fasted conditions (table 1). These observations imply that lower activity of the thyroid hormone axis is a heritable phenotype which contributes to exceptional longevity.

Lower activity of the thyroid hormone axis possibly acts as a mechanism to reallocate energy expenditure from growth and proliferation to protective maintenance. Thyroid hormones primarily regulate the basal metabolic rate of cells, thereby inducing thermogenesis and free radical production⁴¹. Data from model organisms show that low triiodothyronine is associated with lower production of reactive oxygen species (ROS) and ROS inflicted genomic damage⁴². The more efficient transport of electrons through the respiratory chain under conditions of low thyroid hormone might decrease the production of ROS and postpone aging.

Our study demonstrated lower thyroid function in subjects from extremely long-lived families. The prevalence of subclinical hypothyroidism and subclinical hyperthyroidism increase steeply with age⁴³ and the exact definition of subclinical thyroid dysfunction and the requirement for age-specific thyrotropin reference limits in clinical practice is currently a matter of intense debate. Thyrotropin levels are known to gradually increase with age, a shift that was recently shown to extend to advanced age⁴⁴. The higher thyrotropin levels observed at old age possibly result from selective survival of subjects with constitutionally low thyroid function³⁷. Furthermore, some of the changes in thyroid function that occur upon aging may be part of the age related pathology that is caused by accumulated damage, while others may actually occur in response to the accumulation of damage and may instead represent adaptive mechanisms aimed at delaying age-related pathology. Although controversial, the prevailing recommendation is to treat elderly with subclinical hypothyroidism with thyroid hormone supplementation. In view of these considerations however, the issue of reversing the endocrine changes that occur during human aging by treatment of (subclinical) hypothyroidism, remains highly controversial. While pathological changes might benefit from treatment, constitutively low thyroid function or changes in thyroid function that are part of an adaptive response might not.

Upon aging, other changes may occur in the thyroid axis beside an elevation of thyrotropin levels. In **chapter 10**, we demonstrate the existence of a mutual relationship between levels of free triiodothyronine and inflammatory cytokines. High levels of inflammatory cytokines are associated with reduced levels of free triiodothyronine, suggesting that under conditions of inflammation, the activity of the thyroid axis is dampened, possibly via reduced conversion of thyroxine to triiodothyronine.

Conclusion

As average life span continues to increase, so does the number of years spent in ill health. There is an urgent need to identify candidate targets for interventions to prevent age-related loss of function and morbidity. Studies into the phenotype of humans predisposed for an exceptional long life may delineate the determinants for healthy life span extension. Presuming that the characteristics conducive to longevity are transmitted in long-lived families, the offspring from exceptionally long-lived parents may reveal the key to successful aging.

Reference List

- (1) Perls TT, Wilmoth J, Levenson R et al. Life-long sustained mortality advantage of siblings of centenarians. *Proc Natl Acad Sci U S A* 2002;99:8442-8447.
- (2) Westendorp RG, van Heemst D, Rozing MP et al. Nonagenarian siblings and their offspring display lower risk of mortality and morbidity than sporadic nonagenarians: The Leiden Longevity Study. *J Am Geriatr Soc* 2009;57:1634-1637.
- (3) Schoenmaker M, de Craen AJ, de Meijer PH et al. Evidence of genetic enrichment for exceptional survival using a family approach: the Leiden Longevity Study. *Eur J Hum Genet* 2006;14:79-84.
- (4) Perls T, Terry D. Understanding the determinants of exceptional longevity. *Ann Intern Med* 2003;139:445-449.
- (5) Colman RJ, Anderson RM, Johnson SC et al. Caloric restriction delays disease onset and mortality in rhesus monkeys. *Science* 2009;325:201-204.
- (6) Vita AJ, Terry RB, Hubert HB, Fries JF. Aging, health risks, and cumulative disability. *N Engl J Med* 1998;338:1035-1041.
- (7) Terry DF, Wilcox MA, McCormick MA et al. Lower all-cause, cardiovascular, and cancer mortality in centenarians' offspring. *J Am Geriatr Soc* 2004;52:2074-2076.
- (8) Terry DF, Wilcox MA, McCormick MA, Perls TT. Cardiovascular disease delay in centenarian offspring. *J Gerontol A Biol Sci Med Sci* 2004;59:385-389.
- (9) Galioto A, Dominguez LJ, Pineo A et al. Cardiovascular risk factors in centenarians. *Exp Gerontol* 2008;43:106-113.
- (10) Rozing MP, Westendorp RG, de Craen AJ et al. Favorable glucose tolerance and lower prevalence of metabolic syndrome in offspring without diabetes mellitus of nonagenarian siblings: the Leiden longevity study. *J Am Geriatr Soc* 2010;58:564-569.
- (11) Terry DF, Wilcox MA, McCormick MA et al. Lower all-cause, cardiovascular, and cancer mortality in centenarians' offspring. *J Am Geriatr Soc* 2004;52:2074-2076.
- (12) Kenyon C, Chang J, Gensch E, Rudner A, Tabtiang R. A *C. elegans* mutant that lives twice as long as wild type. *Nature* 1993;366:461-464.

- (13) Tatar M, Kopelman A, Epstein D, Tu MP, Yin CM, Garofalo RS. A mutant *Drosophila* insulin receptor homolog that extends life-span and impairs neuroendocrine function. *Science* 2001;292:107-110.
- (14) Brown-Borg HM, Borg KE, Meliska CJ, Bartke A. Dwarf mice and the ageing process. *Nature* 1996;384:33.
- (15) Holzenberger M, Dupont J, Ducos B et al. IGF-1 receptor regulates lifespan and resistance to oxidative stress in mice. *Nature* 2003;421:182-187.
- (16) Russell SJ, Kahn CR. Endocrine regulation of ageing. *Nat Rev Mol Cell Biol* 2007;8:681-691.
- (17) Longo VD, Finch CE. Evolutionary medicine: from dwarf model systems to healthy centenarians? *Science* 2003;299:1342-1346.
- (18) Rozing MP, Westendorp RG, Frolich M et al. Human insulin/IGF-1 and familial longevity at middle age. *Aging (Albany NY)* 2009;1:714-722.
- (19) DeFronzo RA, Bonadonna RC, Ferrannini E. Pathogenesis of NIDDM. A balanced overview. *Diabetes Care* 1992;15:318-368.
- (20) Taylor R. Pathogenesis of type 2 diabetes: tracing the reverse route from cure to cause. *Diabetologia* 2008;51:1781-1789.
- (21) Lillioja S, Mott DM, Howard BV et al. Impaired glucose tolerance as a disorder of insulin action. Longitudinal and cross-sectional studies in Pima Indians. *N Engl J Med* 1988;318:1217-1225.
- (22) Lillioja S, Mott DM, Spraul M et al. Insulin resistance and insulin secretory dysfunction as precursors of non-insulin-dependent diabetes mellitus. Prospective studies of Pima Indians. *N Engl J Med* 1993;329:1988-1992.
- (23) Seppala-Lindroos A, Vehkavaara S, Hakkinen AM et al. Fat accumulation in the liver is associated with defects in insulin suppression of glucose production and serum free fatty acids independent of obesity in normal men. *J Clin Endocrinol Metab* 2002;87:3023-3028.
- (24) Atzmon G, Schechter C, Greiner W, Davidson D, Rennert G, Barzilai N. Clinical phenotype of families with longevity. *J Am Geriatr Soc* 2004;52:274-277.

- (25) Terry DF, Wilcox MA, McCormick MA, Perls TT. Cardiovascular disease delay in centenarian offspring. *J Gerontol A Biol Sci Med Sci* 2004;59:385-389.
- (26) Barzilai N, Atzmon G, Schechter C et al. Unique lipoprotein phenotype and genotype associated with exceptional longevity. *JAMA* 2003;290:2030-2040.
- (27) Heijmans BT, Beekman M, Houwing-Duistermaat JJ et al. Lipoprotein particle profiles mark familial and sporadic human longevity. *PLoS Med* 2006;3:e495.
- (28) Atzmon G, Pollin TI, Crandall J et al. Adiponectin levels and genotype: a potential regulator of life span in humans. *J Gerontol A Biol Sci Med Sci* 2008;63:447-453.
- (29) Paolisso G, Gambardella A, Ammendola S et al. Glucose tolerance and insulin action in healthy centenarians. *Am J Physiol* 1996;270:E890-E894.
- (30) Suh Y, Atzmon G, Cho MO et al. Functionally significant insulin-like growth factor I receptor mutations in centenarians. *Proc Natl Acad Sci U S A* 2008;105:3438-3442.
- (31) van HD, Beekman M, Mooijaart SP et al. Reduced insulin/IGF-1 signalling and human longevity. *Aging Cell* 2005;4:79-85.
- (32) Flachsbart F, Caliebe A, Kleindorp R et al. Association of FOXO3A variation with human longevity confirmed in German centenarians. *Proc Natl Acad Sci U S A* 2009;106:2700-2705.
- (33) Drake NM, Park YJ, Shirali AS, Cleland TA, Soloway PD. Imprint switch mutations at *Rasgrf1* support conflict hypothesis of imprinting and define a growth control mechanism upstream of IGF1. *Mamm Genome* 2009;20:654-663.
- (34) Brown-Borg HM. Hormonal regulation of longevity in mammals. *Ageing Res Rev* 2007;6:28-45.
- (35) Ooka H, Fujita S, Yoshimoto E. Pituitary-thyroid activity and longevity in neonatally thyroxine-treated rats. *Mech Ageing Dev* 1983;22:113-120.
- (36) Tatar M, Bartke A, Antebi A. The endocrine regulation of aging by insulin-like signals. *Science* 2003;299:1346-1351.

Chapter 11

- (37) Atzmon G, Barzilai N, Hollowell JG, Surks MI, Gabriely I. Extreme longevity is associated with increased serum thyrotropin. *J Clin Endocrinol Metab* 2009;94:1251-1254.
- (38) Gussekloo J, van EE, de Craen AJ, Meinders AE, Frolich M, Westendorp RG. Thyroid status, disability and cognitive function, and survival in old age. *JAMA* 2004;292:2591-2599.
- (39) Rozing MP, Houwing-Duistermaat JJ, Slagboom PE et al. Familial longevity is associated with decreased thyroid function. *J Clin Endocrinol Metab*. In press.
- (40) Rozing MP, Westendorp RG, de Craen AJ et al. Low serum free triiodothyronine levels mark familial longevity: the Leiden Longevity Study. *J Gerontol A Biol Sci Med Sci* 2010;65:365-368.
- (41) Harper ME, Seifert EL. Thyroid hormone effects on mitochondrial energetics. *Thyroid* 2008;18:145-156.
- (42) Lopez-Torres M, Romero M, Barja G. Effect of thyroid hormones on mitochondrial oxygen free radical production and DNA oxidative damage in the rat heart. *Mol Cell Endocrinol* 2000;168:127-134.
- (43) Mariotti S, Franceschi C, Cossarizza A, Pinchera A. The aging thyroid. *Endocr Rev* 1995;16:686-715.
- (44) Hollowell JG, Staehling NW, Flanders WD et al. Serum TSH, T(4), and thyroid antibodies in the United States population (1988 to 1994): National Health and Nutrition Examination Survey (NHANES III). *J Clin Endocrinol Metab* 2002;87:489-499.

Part B

ON DETERMINING THE RATE OF SENESCENCE

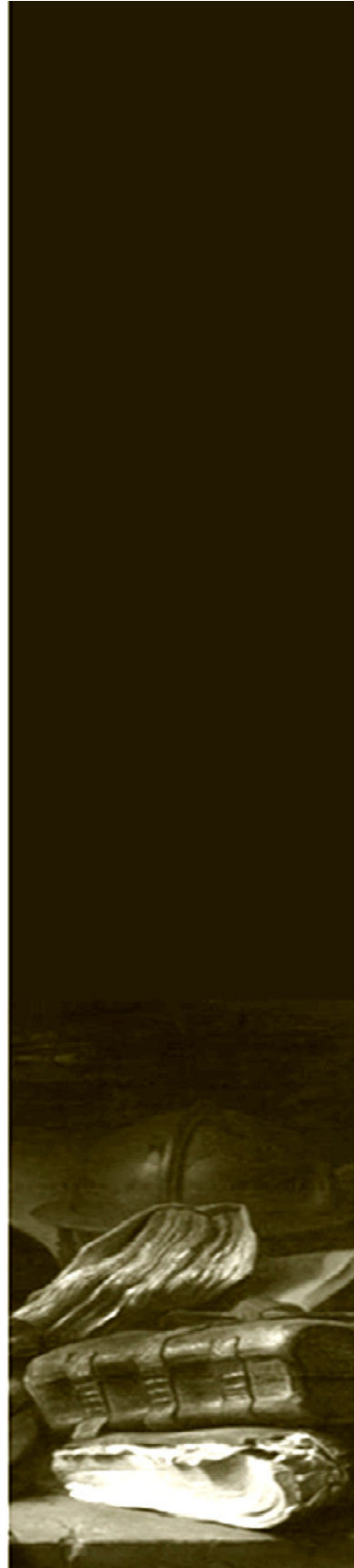

Introduction to Part B

Senescence is quintessentially defined as an increased probability of dying with age. Already 180 years ago Benjamin Gompertz noted that mortality rates of human populations increase exponentially for most age ranges. When the Gompertz equation is transformed semi-logarithmically, it conforms to a straight line, the slope of which has classically been defined as the species-specific senescence rate. Classic inference from the Gompertz law has led to the conclusion that the rate of senescence is unaffected by environmental conditions. The second part of this thesis offers a critical appraisal of the definition of the rate of senescence. In chapter twelve we propose an alternative approach for assessment of the rate of senescence. In chapter thirteen we will empirically test this novel method as compared to the common approach in a population of renal patients, a population known to experience accelerated aging.

Chapter 12: Parallel lines: nothing has changed?

Maarten P. Rozing¹, Rudi G.J. Westendorp¹

From the ¹Department of Gerontology and Geriatrics, Leiden University Medical Center, PO Box 9600, 2300 RC Leiden, The Netherlands.

Aging cell 2008 Dec; 7(6):924-7

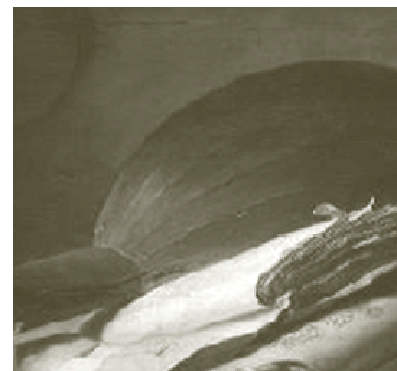

Abstract

The exponential increase in mortality rate with age is a universal feature of aging and is described mathematically by the Gompertz equation. When this equation is transformed semi-logarithmically, it conforms to a straight line, the slope of which is generally used to reflect the rate of senescence. Historical and contemporary data of human and non-human populations show that adverse environmental conditions do not always change the slope of the log mortality rate over age. From these latter observations it is sometimes mistakenly inferred that the rate of senescence is unaffected by environmental conditions. Current biological inference emphasizes that gene action is dependent on the environment in which it is expressed. Here, we propose using the tangent line of the Gompertz equation to assess whether the rate of senescence has altered. Such an approach unmasks different rates of senescence when parameter G has remained constant, an observation that is in line with the notion that a plastic life history trait such as the rate of senescence results from the interplay of both genes and environment.

Senescence is quintessentially defined as an increased probability of dying with age¹. This probability is estimated when following populations with similar genetic background for mortality over time and is expressed as mortality rate per year. Already 180 years ago it was noted by Benjamin Gompertz that mortality rates of human populations increase exponentially for most age ranges². This exponential increase in mortality rate ($m(t)$) over age (t) is mathematically expressed by the equation:

$$m(t) = A_0 e^{Gt} \text{ (Eq. 1)}$$

When the Gompertz equation is transformed semi-logarithmically, it conforms to a straight line described as:

$$\ln m(t) = \ln A_0 + Gt \text{ (Eq. 2)}$$

The slope of this straight line is determined by the Gompertz coefficient (G) and equals the derivative of equation 2.

The Gompertz coefficient (G) is commonly used as an estimate of the rate of senescence³. It is generally interpreted as a measure of intrinsic susceptibility of a biological system to withstand stressors. This intrinsic susceptibility leads to an accumulation of permanent damage to cells and tissues, loss of function and ultimately death, the rate of which is specific for the various species. Current reasoning prevails that decreasing the Gompertz coefficient provides decisive evidence that the rate of senescence is positively influenced.

The parameter A_0 is generally referred to as the “initial mortality rate”, and is alternatively designated as “intrinsic vulnerability”⁴ or “frailty”⁵. The parameter A_0 is commonly estimated at the age of puberty when development is completed and mortality from senescence is at its minimum. When A_0 is estimated that way, it also includes mortality from extrinsic hazards, i.e. environmental mortality that is age independent⁶. To account for this source of mortality separately, Makeham proposed a modification of the Gompertz’ law of mortality⁷.

$$m(t) = C_0 + A_0 e^{Gt} \text{ (Eq. 3)}$$

In which C_0 represents the age independent causes of extrinsic mortality, for example accidents and homicide.

As the rate of senescence is expressed as the acceleration of mortality rate over time, it can take all values. This acceleration can approach negligible values if population mortality rates remain equal over time, and it is inferred that such a population, e.g. hydra, does not undergo senescence⁸. The acceleration of mortality rates over time can also level off at advanced ages⁹ or mortality rates can decelerate as seen during development. It must be emphasized, however, that even in the absence of senescence mortality rates are unlikely to be zero as there are remaining deaths from environmental causes. Immortality is difficult to achieve.

The logic that mortality from intrinsic causes and environmental causes are two independent mechanisms leading to death follows from classic observations of which an example is illustrated in **figure 1a**. The figure shows on a semi-log scale age specific mortality rates of prisoners of war in a Japanese concentration camp. When it is compared to the mortality rates of the Australian civilian population over a similar calendar period, the two lines are parallel^{10, 11}. This parallelism of the mortality curves over age shows that the adverse environment has left the slope (G) unchanged. The general inference of these data is that the rate of senescence is unaffected by an increasingly adverse environment³. If anything, the process of senescence occurs at an earlier age when exposed to adverse conditions.

When the same data on age specific mortality data from the Australian populations are plotted on a linear scale, such a presentation sheds a different light on the interpretation of the parallel curves in the semi-log plot. From **figure 1b** it follows that, when plotted on a linear scale, the difference in age-specific mortality between the prisoners of war and the civilian population is manifold larger in old age when compared to young age. At age 21-25 the mortality rate is 2.3 deaths / 1000/ year among the internees whereas it is 0.7 deaths / 1000/ year in the civilian population (estimated from Jones¹¹). The difference in mortality rate between these populations is 1.6 deaths / 1000/ year. As the two populations are assumed to have a similar genetic background, the extra number of 1.6 deaths/ 1000/ year must be attributable to the incremental environmental hazards to which the internees were exposed. Due to senescence, mortality rate in the civilian population at age 80 has increased to 145.0 deaths/ 1000/ year. When the intrinsic susceptibility and the environment do not interact, we would have expected mortality rate among the internees to be 146.6 deaths/ 1000/ year (145.0 plus 1.6 deaths/ 1000/ year). However, mortality rate among the prisoners of war at age 81-85 is 750.0 deaths/ 1000/ year. The excess number of deaths among 1000 elders who were interned for one year can thus be calculated as 750.0 deaths minus 145.0 deaths as expected from senescence, minus an extra 1.6 death due to the increased environmental hazards in the camp. In the prevailing logic this excess number of 603.4 deaths among the older

internees cannot be accounted for by environmental hazards and is unexplained when the rate of senescence is assumed to be constant.

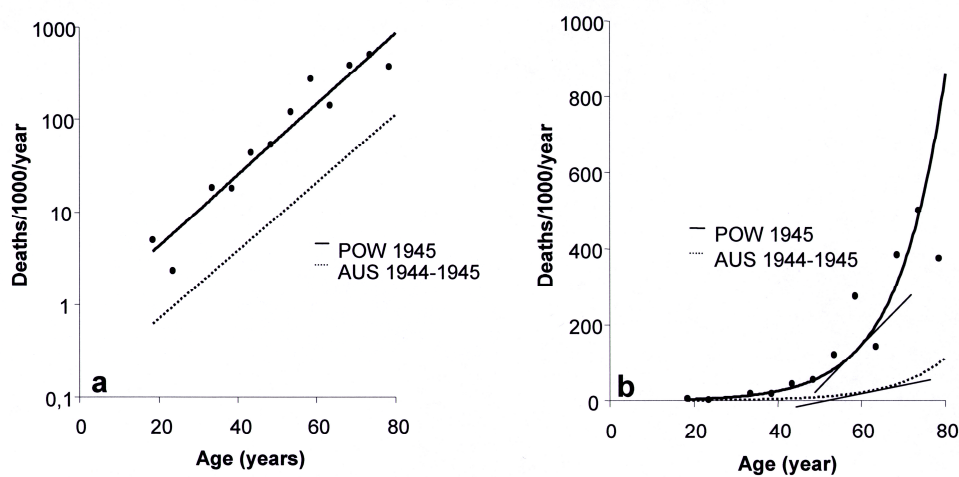

Figure 1. Mortality rates as a function of age for a human population under adverse and affluent conditions. POW: prisoners of war held in concentration camps by the Japanese army during 1945; Aus: Civilians in Australia, 1944-1945. 1a; Plot of the mortality rates as function of age for POW versus Australian civilians on a semi-logarithmic scale 1b; Plot of the mortality rates as a function of age for POW versus Australian civilians on a linear scale. The tangent lines at age of 60 for prisoners of war and civilians are highlighted in blue. Redrawn from Finch³.

When to mathematically describe a biological interaction of risk factors the use of additive models is recommended rather than using multiplicative models¹². It is generally ignored that using linear regression on log transformed data, it effectively has become a multiplicative model. When fitting the regression line, the coefficient presents the *added* value of log mortality when age increases with one unit (equation 2). However, when the equation is exponentiated, to arrive at describing actual mortality rates, it has become the factor with which the mortality rate should be *multiplied* when age increases with one unit. This phenomenon is illustrated when comparing figure 1a and 1b. When the mortality trajectories are plotted on a semi-log scale, visual inspection shows that the lines have shifted upwards but remain parallel. On a linear scale, however, the acceleration of mortality over age under adverse conditions is unmasked. This higher rate of senescence under adverse conditions explains the excess number of 603.4 deaths/ 1000 among the 60 year old prisoners of war that is not accounted for when the rate of senescence is assumed constant, an incorrect conclusion when modeling log transformed data.

It is a striking oddity that when parameter G is used to estimate the rate of senescence, the rate of senescence is not only invariant under different environmental conditions, but is even unaffected by the elapse of time. This would imply that the rate of senescence in a 20 year old civilian is equal to the rate of senescence in an 80 year old internee. This conclusion calls into question the validity of parameter G as an estimate for the rate of senescence.

The enigma of biology is to explain phenotypic characteristics as the result of genes that are expressed in a specific environment. Phenotypic characteristics can be markedly dissimilar in different environments despite the genetic background of the organism being identical¹³⁻¹⁵. Gene-by-environmental interactions account for a large component of the variance in gene expression and there is no reason to assume that senescence should be exempt. It follows that the rate of senescence results from an interaction between intrinsic susceptibility and specific environmental conditions. Despite the constancy of parameter G in the Gompertz equation, the rate of senescence can vary widely under different conditions and in different age categories.

Following the notion that genes interact with environmental cues and that the rate of senescence can best be studied using absolute figures, the slope of the Gompertz curve would be the most appropriate estimate of the rate of senescence. When mortality rates are expressed on an absolute scale (figure 1b) the slope of the tangent line at the age 60 years is much steeper among the prisoners of war when compared to the civilian population, indicating that the rate of senescence is far higher under adverse conditions. The slope of the Gompertz curve, i.e. the first derivative, can be expressed for every given age (t) as:

$$m'(t) = A_0 G e^{Gt} \text{ (Eq. 4)}$$

with the expression unit being (deaths/ 1000 persons/ year) per year, which is the derivative of equation 1. Whatever may be the biological substrate for the parameters A_0 and G , it is apparent that the rate of senescence $m'(t)$ results from a multiplication of both parameters and varies with age (t).

When using equation 4, describing the slope of the tangent line to estimate the rate of senescence as the combined effect of genetic background and environmental cues, it becomes clear that the Gompertz equation may reasonably well describe the patterns of mortality over age, but does not line up with current biological knowledge. The Gompertz law of mortality was formulated long before molecular insights in the biology of aging were accrued.

Alternative to the Gompertz model, power functions like the Weibull model are also used to express the mortality rate in a population ¹⁶:

$$W(t) = C_0 + \alpha t^\beta \text{ (Eq. 5)}$$

In equation 5 the age-dependent component αt^β is added to the initial mortality rate C_0 . The slope of the Weibull model, an estimate for the rate of senescence, is expressed by the first derivative of equation (5):

$$W'(t) = \alpha \beta t^{(\beta-1)} \text{ (Eq. 6)}$$

The rate of senescence described by equation (6), results from the interaction of two parameters, α and β . Similar to the derivative of the Gompertz model 4, the rate of senescence $W'(t)$ is dependent on age (t). Over the adult range, curve fitting leads to no clear preference of one model over the other ¹⁷. Although, the derivatives of the Weibull and Gompertz models both adequately describe the rate of senescence in mathematical terms, the isolated parameters cannot be interpreted in biological terms.

Classic inference from the Gompertz law may have lead to incorrect conclusions. In industrialized human societies worldwide, mortality rates have been declining steadily for over a century. These declines have been associated solely with a reduction in initial mortality rates, with no reduction in the slope of the mortality trajectory ¹⁸. This lowering of the mortality trajectory has been taken to indicate that overall health at all ages has improved, but that the underlying process of accumulation of permanent damage has not been ameliorated.¹⁹ Here, we argue that this conclusion may be mistaken.

In model organisms, there are various examples of interventions which that have been shown to extend the average and maximum lifespan, and, some are reflected in a lower slope of the mortality trajectory ^{20, 21}. Many of these experiments involve the restriction of calorie intake ^{4, 22}. In contrast, various data on genetic manipulation of experimental models also show an increase of average and maximal lifespan, but when expressed on a semi-log scale the age specific mortality trajectories have shifted parallel when compared to the control strains²³⁻²⁶. For these latter examples, the nowadays interpretation is one of disappointment, as if the process of senescence had not be influenced positively. The correct interpretation of these data, however, is that the tangent line, i.e. the acceleration of mortality, is markedly different. Despite the fact that the tangent line better reflects the decreased rate of senescence, the mathematical formula however,

Chapter 12

does not allow for testing biological plausible hypotheses. There is an urgent need for new mathematical models that adequately fit the increase of mortality rate over age and at the same time enable studying the biology of senescence that lines up with current scientific insights.

Acknowledgements

The authors are grateful to M. Tatar, N.A. Aziz and J.J. Houwing for their critical comments on an earlier version of the manuscript.

Reference List

- (1) Medawar PB. *An unsolved Problem of Biology An inaugural lecture delivered at University College London, 6 December 1951*. London: Lewis H.K. & Co.; 2010.
- (2) Gompertz B. On the nature of the function of the law of human mortality and a new mode of determining the value of life contingencies. *Phil Trans R Soc* 1825;2:513-85.
- (3) Finch CE. *Longevity, Senescence and the Genome*. London: University of Chicago Press; 1994.
- (4) Sacher GA. *Handbook of the Biology of Aging*. New York: Van Nostrand Rheinhold; 1977.
- (5) Vaupel JW, Manton KG, Stallard E. The impact of heterogeneity in individual frailty on the dynamics of mortality. *Demography* 1979 August;16(3):439-54.
- (6) Finch CE, Pike MC, Witten M. Slow mortality rate accelerations during aging in some animals approximate that of humans. *Science* 1990 August 24;249(4971):902-5.
- (7) Makeham WM. On the law of mortality. *J Inst Actuaries and Assur* 2010;8:301-10.
- (8) Martinez DE. Mortality patterns suggest lack of senescence in hydra. *Exp Gerontol* 1998 May;33(3):217-25.
- (9) Vaupel JW, Baudisch A, Dolling M, Roach DA, Gampe J. The case for negative senescence. *Theor Popul Biol* 2004 June;65(4):339-51.
- (10) Bergman RA. Death rate in a Japanese concentration camp as a criterion of age. *J Gerontol* 1948 January;3(1):14-7.
- (11) Jones H.B. The Relation of Human Health to Age, Place and Time. In: Birren J.E., editor. *Handbook of Aging and the Individual*. London: Chicago University Press; 2010. p. 336-63.
- (12) Greenland S., Rothman K.J. Concepts of interaction. In: Rothman K.J., editor. *Modern Epidemiology*. Philadelphia: Lipncott-Raven; 1998. p. 329-432.
- (13) Agrawal AA. Phenotypic plasticity in the interactions and evolution of species. *Science* 2001 October 12;294(5541):321-6.

- (14) Garland T, Jr., Kelly SA. Phenotypic plasticity and experimental evolution. *J Exp Biol* 2006 June;209(Pt 12):2344-61.
- (15) Price TD, Qvarnstrom A, Irwin DE. The role of phenotypic plasticity in driving genetic evolution. *Proc Biol Sci* 2003 July 22;270(1523):1433-40.
- (16) Eakin T, Shouman R, Qi Y, Liu G, Witten M. Estimating parametric survival model parameters in gerontological aging studies: methodological problems and insights. *J Gerontol A Biol Sci Med Sci* 1995 May;50(3):B166-B176.
- (17) Ricklefs RE, Scheuerlein A. Biological implications of the Weibull and Gompertz models of aging. *J Gerontol A Biol Sci Med Sci* 2002 February;57(2):B69-B76.
- (18) Wilmoth JR. Demography of longevity: past, present, and future trends. *Exp Gerontol* 2000 December;35(9-10):1111-29.
- (19) Partridge L, Pletcher SD, Mair W. Dietary restriction, mortality trajectories, risk and damage. *Mech Ageing Dev* 2005 January;126(1):35-41.
- (20) de Magalhaes JP, Cabral JA, Magalhaes D. The influence of genes on the aging process of mice: a statistical assessment of the genetics of aging. *Genetics* 2005 January;169(1):265-74.
- (21) Johnson TE. Increased life-span of age-1 mutants in *Caenorhabditis elegans* and lower Gompertz rate of aging. *Science* 1990 August 24;249(4971):908-12.
- (22) Masoro EJ. Caloric restriction and aging: an update. *Exp Gerontol* 2000 May;35(3):299-305.
- (23) Flurkey K, Papaconstantinou J, Miller RA, Harrison DE. Lifespan extension and delayed immune and collagen aging in mutant mice with defects in growth hormone production. *Proc Natl Acad Sci U S A* 2001 June 5;98(12):6736-41.
- (24) Good TP, Tatar M. Age-specific mortality and reproduction respond to adult dietary restriction in *Drosophila melanogaster*. *J Insect Physiol* 2001 December;47(12):1467-73.
- (25) Lin YJ, Seroude L, Benzer S. Extended life-span and stress resistance in the *Drosophila* mutant methuselah. *Science* 1998 October 30;282(5390):943-6.

- (26) Mair W, Goymer P, Pletcher SD, Partridge L. Demography of dietary restriction and death in *Drosophila*. *Science* 2003 September 19;301(5640):1731-3.

Chapter 13: Senescence rates in patients with end-stage renal disease: a critical appraisal of the Gompertz model

Jacob J.E. Koopman^{1,2,3}, Maarten. P. Rozing¹, Anneke Kramer⁴, Dinanda J. de Jager³, David Ansell⁵, Johan M.J. De Meester⁶, Karl G. Prütz⁷, Patrik Finne⁸, James G. Heaf⁹, Runolfur Pálsson¹⁰, Reinhard Kramar¹¹, Kitty J. Jager⁴, Friedo W. Dekker^{3,4}, Rudi G.J. Westendorp^{1,2,*}

From the ¹ Department of Gerontology and Geriatrics, Leiden University Medical Center, Leiden, the Netherlands; ² Leyden Academy on Vitality and Ageing, Leiden, the Netherlands; ³ Department of Clinical Epidemiology, Leiden University Medical Center, Leiden, the Netherlands; ⁴ ERA-EDTA Registry, Department of Medical Informatics, Academic Medical Center Amsterdam, University of Amsterdam, Amsterdam, the Netherlands; ⁵ UK Renal Registry, Southmead Hospital, Bristol, United Kingdom; ⁶ AZ Nikolaas, Department of Nephrology, Dialysis and Hypertension, Sint-Niklaas, Belgium; ⁷ Swedish Renal Registry, Department of Nephrology and Transplantation, Skåne University Hospital, Malmö, Sweden; ⁸ Finnish Registry for Kidney Diseases, Helsinki, Finland; ⁹ Department of Nephrology B, Herlev Hospital, University of Copenhagen, Herlev, Denmark; ¹⁰ Division of Nephrology, Landspítali University Hospital and Faculty of Medicine, School of Health Sciences, University of Iceland, Reykjavik, Iceland; ¹¹ Austrian Dialysis and Transplant Registry, Kematen/Krems, Austria

Aging Cell. 2011 Apr;10(2):233-238.



Abstract

The most frequently used model to describe the exponential increase in mortality rate over age is the Gompertz equation. Logarithmically transformed, the equation conforms to a straight line, of which the slope has been interpreted as the rate of senescence. Earlier, we proposed the derivative function of the Gompertz equation as a superior descriptor of senescence rate. Here, we tested both measures of the rate of senescence in a population of patients with end-stage renal disease. It is a clinical dogma that patients on dialysis experience accelerated senescence, whereas those with a functional kidney transplant have mortality rates comparable to the general population. Therefore, we calculated the age-specific mortality rates for European patients on dialysis ($n=274,221$; follow-up= $594,767$ person-years), for European patients with a functioning kidney transplant ($n=61,286$; follow-up= $345,024$ person-years), and for the general European population. We found higher mortality rates, but a smaller slope of logarithmical mortality curve for patients on dialysis compared to both patients with a functioning kidney transplant and the general population ($p<0.001$). A classical interpretation of the Gompertz model would imply that the rate of senescence in patients on dialysis is lower than in patients with a functioning transplant and lower than in the general population. In contrast, the derivative function of the Gompertz equation yielded highest senescence rates for patients on dialysis, whereas the rate was similar in patients with a functioning transplant and the general population. We conclude that the rate of senescence is better described by the derivative function of the Gompertz equation.

Introduction

In 1825, Benjamin Gompertz observed that human mortality rates increase exponentially with age¹. Since then, no other definition of senescence has gained so much common acceptance². Mathematically, the model is known as the Gompertz equation and has become the most frequently used model of senescence^{3, 4}. The model describes the mortality rate at a given age with parameters α and γ . When transformed semilogarithmically, the formula conforms to a straight curve, hereinafter referred to as the Gompertz curve. The slope of this straight curve is determined by parameter γ .

The Gompertz model fits mortality data very firmly, but it is purely empirical. Still, many investigators have tried to attribute biological properties to the estimated parameters. Based on mortality data from animal experiments⁵⁻⁸ and historical changes in human mortality patterns⁹⁻¹², the slope of the logarithmically transformed Gompertz curve has classically been defined as the species-specific senescence rate^{2, 13}. However, based on theoretical considerations, the validity of the slope of the Gompertz curve as a measure of the senescence rate has been criticized¹⁴⁻¹⁶. We have previously proposed to use the tangent of the mortality curve instead, as described by the derivative of the Gompertz equation¹⁷.

This work aims to empirically test both the classical and the newly proposed measure of senescence rate in end-stage renal disease patients. Hereto, we have calculated the age-specific mortality rates of a very large population of European patients with end-stage renal disease, comprising both patients on dialysis and with a functioning kidney transplant, using the general European population as a reference. It has been widely recognized that renal disease patients on dialysis show accelerated senescence when compared to the general population^{18, 19}. Furthermore, after transplantation, the mortality pattern of these patients converts toward the mortality pattern of the general population^{20, 21}, although this effect might also partly be due to selection of healthy subjects for transplantation. Therefore, these populations provide an excellent opportunity to assess different measures of the rate of senescence, as a valid measure of senescence rate should reflect these differences in senescence rates by attributing the highest senescence rate to patients on dialysis, and a lower senescence rate to patients with a functioning kidney transplant and the general population.

Materials and methods

The study population of patients with end-stage renal disease was derived from the Registry of the European Renal Association – European Dialysis and Transplant Association²² (ERA-EDTA Registry), which records European patients who receive renal replacement therapy, either dialysis

or kidney transplantation. Via national and regional registries individual patient data were derived from Austria, the Flemish speaking region of Belgium, the French speaking region of Belgium, Denmark, Finland, Greece, Iceland, the Netherlands, Norway, Romania, Sweden, the United Kingdom, and from several regions in Italy and Spain. Data were gathered during a period beginning between 1985 and 2007, and ending at 1 January 2008 for four regions in Spain and Italy and 1 January 2009 for the other regions and countries. For each individual patient the following parameters were collected at baseline: country or region of origin, date of birth, sex, primary cause of renal failure, and date and modality of first renal replacement therapy. History of renal replacement therapy with dates and changes of modality and date were collected during follow-up. Primary renal diseases were classified according to the ERA-EDTA coding system (ERA-EDTA Registry Annual Report 2008, 2010).

Mortality rates were calculated based on the follow-up data contributed by each individual patient, separated for follow-up on dialysis treatment and follow-up with a functioning kidney transplant. In case of the dialysis group, follow-up began six months after initiation of dialysis treatment, to account for acute treatment-related mortality²³, and lasted until death, transplantation, recovery of renal function, loss to follow-up, or censoring at 1 January 2008 or 2009. In case of the patients with a functioning transplant, follow-up began six months after transplantation, to account for acute surgery-related mortality^{20, 24}, and lasted until death, transfer to dialysis due to transplant failure, loss to follow-up, or censoring at 1 January 2008 or 2009. For both treatment groups, per five-year age group the number of deaths was divided by the years of follow-up, yielding the age-specific mortality rates.

The application of the Gompertz model is limited to mortality data between the ages of approximately 20 and 80 to 90 years³. Moreover, after the age of 85 years, available mortality data was scarce. Follow-up after this age comprised 15,638 person-years (2.52%) and 8,360 deaths (5.83%) for the patient group on dialysis and 175 person-years (0.05%) and 25 deaths (0.26%) for the patient group with a functioning kidney transplant. Therefore, data on patients below the age of 20 years and from the age of 85 years onward were excluded from this study.

Mortality data of the general European population were available through the Human Mortality Database²⁵ and Eurostat²⁶. For the countries in our study, the population and death figures were retrieved from the HMD for each five-year age category and for the years of data contribution. For Greece, Romania, and Spain these mortality data were downloaded from Eurostat, as they were not available through the HMD. For the calculation of age-specific mortality rates of the

general European population, per five-year age groups and years of participation, the sum of all deaths was divided by the sum of all inhabitants of the participating countries.

The Gompertz curves were characterized by estimating the values of the parameters of the Gompertz model on the age-specific mortality data as well as the statistical significance of the differences in the model parameters between the treatment groups. The parameters α and γ are mathematically described by the Gompertz model as $m(t) = \alpha e^{\gamma t}$, where $m(t)$ is the mortality rate and t is the age in years. The calculations were performed by fitting the parametric proportional hazards Gompertz model ²⁷ on the individual patient data and by linear regression on the aggregated data of the general European population.

The classical senescence rates were given by γ , of which the values were derived by the aforementioned determination of the model parameters. In addition, according to the newly proposed analytical method that we have described earlier ¹⁷, the derivative function of the Gompertz equation was applied to the mortality curves of this study to determine the senescence rates. Hereto, the values of the model parameters, determined as described above, were incorporated in the derivative equation: $m(t) = \alpha \gamma e^{\gamma t}$.

The management of the ERA-EDTA Registry database, the calculations of the age-group-specific mortality rates of the patient population, and the linear regression analyses were carried out using PASW Statistics 17.0 (IBM SPSS Statistics). Linear regression was performed by the linear mixed model with the natural logarithms of the mortality rates as dependent variable, treatment group as factor, and age as covariate. All these calculations were repeated using Stata/SE 10.1 (StataCorp LP). The fitting of the Gompertz model was performed using Stata/SE 10.1.

Results

Table 1 shows the basic characteristics of the patient population, both presented as the total number of patients and by the number of years of follow-up. As starting dialysis treatment or receiving kidney transplantation occurred more than once in some patients, part of the population ($n=58,387$ or 20.1%) contributed follow-up to both treatment modalities. The number of these consecutive treatment modalities ranged between 1 and 11 per patient.

Figure 1a shows the mortality rates per five-year age groups for patients on dialysis, for patients with a functioning kidney transplant, and for the general population. In all groups, mortality rates increased exponentially over age from adolescence onward. For each age group, the mortality rate of the dialysis patients was highest, whereas the mortality rate of patients with a functioning

transplant was higher than that of the general population. After transformation of the mortality rates to a semilogarithmical scale, the mortality curves of all three groups conformed to straight Gompertz curves from the age of 20 years and onward (**figure 1b**). The r^2 values of these straight curves, indicating the fit of the Gompertz model, were 0.998 for patients on dialysis, 0.992 for patients with a functioning transplant, and 0.986 for the general population. Again, for each age group, the mortality rate of the patients on dialysis was highest, the mortality rate of the group with a functioning transplant was intermediate, and the mortality rate of the general population was lowest.

Table 1. General characteristics of the end-stage renal disease patient population

Characteristic	Total	On dialysis	With a functioning transplant
By number of patients			
Total amount of patients <i>n</i>	290,510	274,221	61,286
Sex % male	61.1	61.2	62.7
Age median (<i>iqr</i>)			
- at first treatment	64.6 (52.0-73.3)	65.0 (52.7-73.5)	49.2 (38.3-58.6)
- at death	71.0 (62.7-77.1)	71.1 (62.8-77.1)	60.5 (51.5-68.2)
Follow-up per patient median years (<i>iqr</i>)	1.8 (0.3-4.7)	1.3 (0.2-3.1)	4.5 (1.4-8.7)
By contributed years of follow-up			
Total years of follow-up <i>person-years</i> (%)	942,458	594,767 (63.1)	345,024 (36.6)
Sex % male	60.4	59.3	62.2

General characteristics of the patients with end-stage renal disease, presented by the number of patients and by contributed years of follow-up. *iqr*: interquartile range.

The quantitative description of the Gompertz curves by the model parameters is presented in **table 2**. The intercept or basal mortality rate α of the Gompertz curve of patients with a functioning kidney transplant was higher than that of the general population ($p < 0.001$), while α for the patients on dialysis was higher than that of both other groups ($p < 0.001$). The slope γ of the Gompertz curve of the patients with a functioning transplant was lowest for the patients on dialysis, intermediate for the patients with a functioning transplant, and highest for the general

population ($p < 0.001$). The corresponding mortality rate doubling time was highest for the dialysis patients, intermediate for the patients with a functioning transplant, and lowest for the general population. We performed various additional analyses. Stratification of the mortality rates of patients on renal replacement therapy by sex, primary renal disease, and country of origin yielded similar results. Stratification by calendar year, for which the data were divided in two periods from 1985 through 1996 and from 1997 through 2008, yielded similar results. Inclusion of only the first treatment period on dialysis or with a functioning transplant, did not affect the outcome. Furthermore, adjustment for duration of follow-up for different treatment modalities did not substantially influence the results (data not shown).

Next, we estimated the tangent of the mortality curve as described by the derivative of the Gompertz equation to determine the senescence rates for the various groups. The derivative function yielded estimates for the age-specific senescence rates as depicted in **figure 2**. At every age, the senescence rate was highest in patients on dialysis when compared to patients with a functioning kidney transplant and to the general population. Contrary to a fixed senescence rate as determined by parameter γ in the Gompertz equation, senescence rates accelerated over age. This acceleration was fastest in patients on

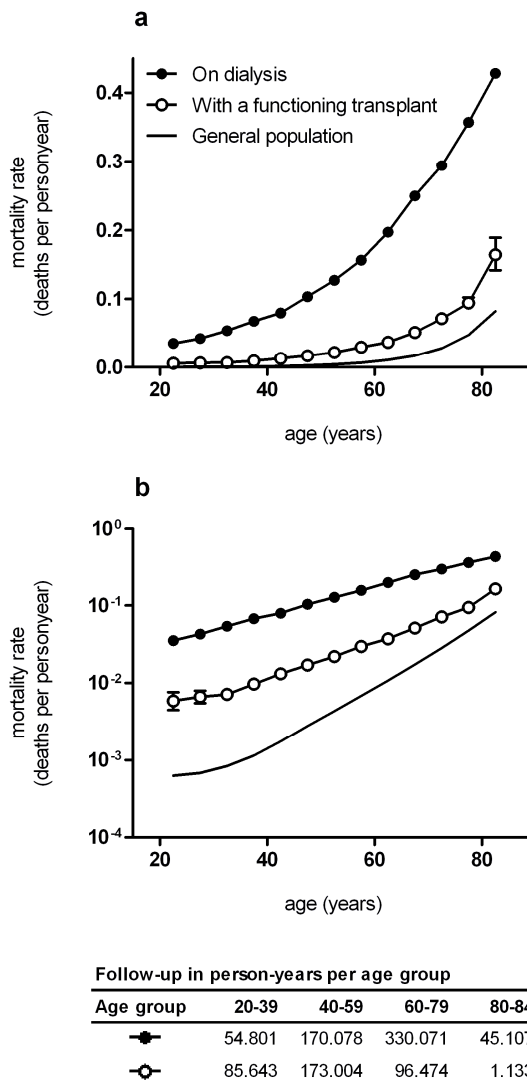

Figure 1. Age-specific mortality rates of patients on dialysis, patients with a functioning kidney transplant, and the general population on a linear scale (a) and on a semilogarithmic scale (b). Logarithmic transformation of the mortality curves yields straight Gompertz curves, of which the slopes have classically been interpreted as the senescence rate. For the mortality rates of the patients on dialysis and with a functioning transplant, the estimates are given with 95% confidence intervals. The follow-up in person-years for each treatment modality is shown in the table at the bottom of this figure.

dialysis. Senescence rates estimated by the derivative of the Gompertz equation became similar to those of the general population when the patients with end-stage renal disease had a functioning kidney transplant (**figure 2**). These estimates do not preclude that age-specific mortality rates are higher in patients with a functioning transplant than in the general population for every age category.

Table 2. Quantitative description of the Gompertz model parameters

Parameter	On dialysis	With a functioning transplant	General pop.
$\ln \alpha$	-4.75 (-4.71; -4.79)	-7.71 (-7.58; -7.83)	-9.55
$\alpha \times 10^{-2}$	0.86 (0.83; 0.90)	0.04 (0.04; 0.05)	0.01
$\gamma \times 10^{-2}$	4.29 (4.23; 4.35)	6.70 (6.49; 6.90)	8.50
MRDT	16.17 (15.95; 16.40)	10.35 (10.05; 10.68)	8.16

Estimated values of the Gompertz model parameters for the mortality curves of patients on dialysis, patients with a functioning kidney transplant, and the general population. The mortality rate doubling times (MRDT) are given in years, derived from γ by $\text{MRDT} = \ln 2 / \gamma$ (Ricklefs and Scheuerlein, 2002). The values for α were derived from those for $\ln \alpha$. The estimates are given with 95% confidence intervals. All estimates of the parameters were significantly different between the three groups and from zero ($p < 0.001$).

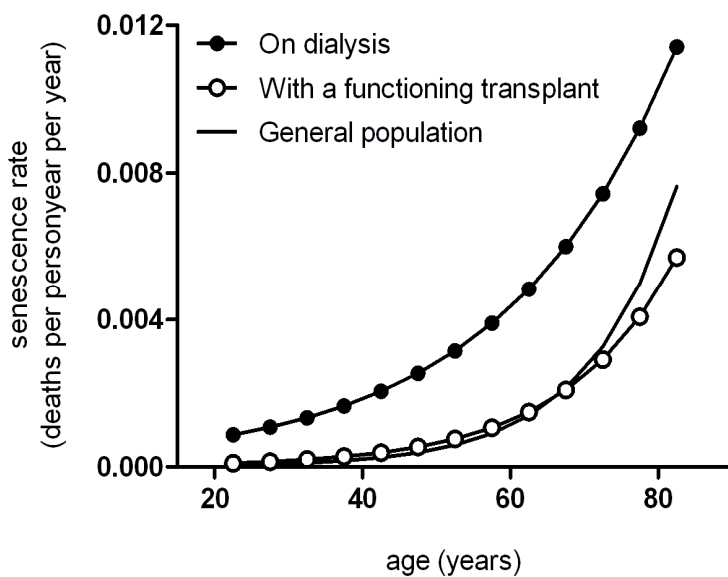

Figure 2. Age-specific senescence rates of patients on dialysis, patients with a functioning kidney transplant, and the general population. It is emphasized that, in contrast to the mortality rates in Figure 1, these curves depict senescence rates. According to the newly proposed method, these senescence rates were calculated using the derivative of the Gompertz equation. Values of the Gompertz model parameters, as presented in Table 2, were incorporated into this equation.

Discussion

In this work, we have tested two estimates of senescence rate using a population of end-stage renal disease patients as a model of accelerated senescence. When compared to the general population, patients on dialysis have higher mortality rates^{19, 28}. Moreover, they suffer from age-related diseases with a higher frequency and more rapid progression, among which there are cardiovascular diseases^{21, 28, 29}, cognitive impairment and dementia²⁹, metabolic bone disease³⁰, and dysfunction of the immune system. After successful kidney transplantation, the accelerated rate of senescence in the end-stage renal disease patients approaches the senescence rate of the general population^{20, 21}. These populations therefore provide an excellent opportunity to assess different measures of the rate of senescence.

The commonly used Gompertz model describes the mortality rate $m(t)$ at a given age t with parameters α and γ as:

$$m(t) = \alpha e^{\gamma t} \text{ (Eq. 1)}$$

The parameter α determines the intercept of the curve, also referred to as the basal mortality rate, and is usually set at adolescence. The parameter γ determines the extent of the age-dependent increase in the mortality rate^{3, 31}. On a semilogarithmical scale, the curve conforms to a straight line, the Gompertz curve, which is described as:

$$\ln m(t) = \ln \alpha + \gamma t \text{ (Eq. 2)}$$

On the semilogarithmical scale, variation in α results in a parallel shift of the Gompertz curve, whereas variation in γ results in a different slope. The slope of the Gompertz curve has classically been regarded as the best estimate of the senescence rate^{2, 13}. As an alternative estimate of the senescence rate, we have proposed to use the derivative of the Gompertz equation¹⁷, described as:

$$m'(t) = \alpha \gamma e^{\gamma t} \text{ (Eq. 3)}$$

Using the mortality data of a unique and unprecedented large population of patients with end-stage renal disease, both the classical measure of the senescence rate, based on the slope γ of the Gompertz curve and the newly proposed measure of the senescence rate, estimated by the derivative of the Gompertz equation, we have obtained the following results. We showed that the mortality rates of patients on dialysis were highest and the slope of their Gompertz curve was

lowest when compared to patients with a functioning kidney transplant and the general population. In patients with a functioning transplant the mortality rates and the slope were intermediate. In the general population, the mortality rates were lowest, but the slope was highest compared to both patient groups. The classical interpretation of the parameters of the Gompertz model should lead to the conclusion that the senescence rate in patients on dialysis is lower than the senescence rate in patients with a functioning transplant as well as the general population. Moreover, a successful kidney transplantation lowers the mortality rates, but would increase the senescence rate. This interpretation of the parameter estimates is in sharp contrast to the clinical notion that patients on dialysis experience an accelerated senescence, whereas after transplantation the mortality pattern of patients shifts toward the mortality pattern of the general population. We have presented the first derivative of the Gompertz equation as an alternative measure of the senescence rate. This measure yields senescence rates that are highest for patients on dialysis compared to patients with a functioning transplant and the general population. The senescence rates of the group with a functioning transplant and the general population are similar, although the age-specific mortality rates are higher in patients with a functional transplant than in the general population for every age category. Only at the highest ages, the senescence rates of patients with a functioning transplant slightly lag behind those of the general population. In contrast to the classical interpretation of parameter γ as a measure of the rate of senescence, this result is consistent with the higher senescence rates observed in patients on dialysis compared with the general population and with the presumed return to normal mortality patterns after successful kidney transplantation. It should be noted however that the post transplant mortality conversion might partly be due selection bias of the transplanted cohort rather than a conversion in the mortality rate.

While Benjamin Gompertz was the first to introduce a mortality model, many alternative models that fit human mortality data have since been proposed that fit human mortality data even better ⁴, ³²⁻³⁴. The quest here is not to arrive at the best statistical fit of the data, but to obtain parameters that can be estimated empirically and represent biological phenomena. The approach that is presented here, to estimate the senescence rate using the derivative function of the Gompertz equation is such an attempt. This model is likely to be applicable to any model that fits mortality patterns. The approach presented here is solely based on the definition of senescence as an increase in mortality rate over age and is independent of any biological interpretation of the model from which it is derived, as long as the model fits the mortality data. Other models may even be preferred over the Gompertz model, as the Gompertz model is limited to fit mortality data between adolescence and the age of 80 to 90 years ³. It would, therefore, be worthwhile to

empirically test the validity of this interpretation of the derivative for alternative models as well

35

In conclusion, this study shows that empirically testing of parameter γ of the Gompertz curve as a measure of senescence rate, failed to identify the high senescence rate in patients with end-stage renal disease on dialysis and did not identify the improvement when these patients undergo kidney transplantation. In contrast, the recently proposed alternative measure of senescence rate, determined by the derivative function of the Gompertz equation, estimates the highest senescence rates for dialysis patients and recognizes the improved prognosis of patients with a functioning kidney transplant. Thus, we propose to use the derivative of the Gompertz equation to estimate the rate of senescence.

Acknowledgements

The authors are grateful to dr. A.J.M. de Craen, dr. S. le Cessie, prof.dr. T. Stijnen, and K. Meilgaard for their valuable comments.

Reference List

- (1) Gompertz B. On the nature of the function expressive of the law of human mortality, and on a new mode of determining the value of life contingencies. *Phil Trans R Soc Lond* 1825;115:513-85.
- (2) Finch CE. *Longevity, Senescence, and the Genome*. Chicago: The University of Chicago Press; 1990.
- (3) Golubev A. How could the Gompertz-Makeham law evolve. *J Theor Biol* 2009;258(1):1-17.
- (4) Olshansky SJ, Carnes BA. Ever since Gompertz. *Demography* 1997;34(1):1-15.
- (5) de Magalhães JP. The influence of genes on the aging process of mice: a statistical assessment of the genetics of aging. 2005.
- (6) Johnson TE. Increased life-span of *age-1* mutants in *Caenorhabditis elegans* and lower Gompertz rate of aging. 1990.
- (7) Mair W, Goymer P, Pletcher SD, Partridge L. Demography of dietary restriction and death in *Drosophila*. *Science* 2003 September 19;301(5640):1731-3.
- (8) Partridge L, Piper MD, Mair W. Dietary restriction in *Drosophila*. *Mech Ageing Dev* 2005 September;126(9):938-50.
- (9) Bergman RA. Death rate in a Japanese concentration camp as a criterion of age. *J Gerontol* 1948 January;3(1):14-7.
- (10) Jones HB. The relation of human health to age, place, and time. 1959.
- (11) Riggs JE. Longitudinal Gompertzian analysis of adult mortality in the U.S., 1900-1986. *Mech Ageing Dev* 1990 June;54(3):235-47.
- (12) Vaupel JW, Carey JR, Christensen K. Aging. It's never too late. *Science* 2003 September 19;301(5640):1679-81.
- (13) Partridge L, Pletcher SD, Mair W. Dietary restriction, mortality trajectories, risk and damage. *Mech Ageing Dev* 2005;126:35-41.

- (14) Driver C. The Gompertz function does not measure ageing. *Biogerontology* 2001;2(1):61-5.
- (15) Hawkes K, Smith KR, Robson SL. Mortality and fertility rates in humans and chimpanzees: How within-species variation complicates cross-species comparisons. *Am J Hum Biol* 2009 July;21(4):578-86.
- (16) Masoro EJ. Caloric restriction and aging: controversial issues. *J Gerontol A Biol Sci Med Sci* 2006 January;61(1):14-9.
- (17) Rozing MP, Westendorp RGJ. Parallel lines: nothing has changed? *Aging Cell* 2008;7(6):924-7.
- (18) Johansen KL, Chertow GM, Jin C, Kutner NG. Significance of frailty among dialysis patients. *J Am Soc Nephrol* 2007;18(11):2960-7.
- (19) Pecoits-Filho R, Sylvestre LC, Stenvinkel P. Chronic kidney disease and inflammation in pediatric patients: from bench to playground. *Pediatr Nephrol* 2005;20:714-20.
- (20) Meier-Kriesche HU, Schold JD. The impact of pretransplant dialysis on outcomes in renal transplantation. *Semin Dial* 2005;18(6):499-504.
- (21) Nolan CR. Strategies for improving long-term survival in patients with ESRD. *J Am Soc Nephrol* 2005;16:S120-S127.
- (22) ERA-EDTA Registry Annual Report 2008.
- (23) Ansell D, Roderick P, Steenkamp R, Tomson CR. UK Renal Registry 12th Annual Report (December 2009): Chapter 7: Survival and causes of death of UK adult patients on renal replacement therapy in 2008: national and centre-specific analyses. *Nephron Clin Pract* 2010;115 Suppl 1:c117-c144.
- (24) McDonald SP, Russ GR. Survival of recipients of cadaveric kidney transplants compared with those receiving dialysis treatment in Australia and New Zealand, 1991-2001. *Nephrol Dial Transplant* 2002;17:2212-9.
- (25) Human Mortality Database. <http://www.mortality.org/> 2010.

- (26) Eurostat. http://epp.eurostat.ec.europa.eu/portal/page/portal/statistics/search_database . 2010.
- (27) *Stata Survival Analysis and Epidemiological Table Reference Manual*. Release 10 ed. College Station: StataCorp LP; 2007.
- (28) de Jager DJ, Grootendorst DC, Jager KJ et al. Cardiovascular and noncardiovascular mortality among patients starting dialysis. *JAMA* 2009 October 28;302(16):1782-9.
- (29) Krishnan AV, Kiernan MC. Neurological complications of chronic kidney disease. *Nat Rev Neurol* 2009 October;5(10):542-51.
- (30) Nickolas TL, Leonard MB, Shane E. Chronic kidney disease and bone fracture: a growing concern. *Kidney Int* 2008;74(6):721-31.
- (31) Ricklefs RE, Scheuerlein A. Biological implications of the Weibull and Gompertz models of aging. *J Gerontol A Biol Sci Med Sci* 2002;57(2):B69-76.
- (32) Gavrilov LA, Gavrilova NS. The reliability theory of aging and longevity. *J Theor Biol* 2001 December 21;213(4):527-45.
- (33) Milne EM. The natural distribution of survival. *J Theor Biol* 2008 November 21;255(2):223-36.
- (34) Weibull W. A statistical distribution function of wide applicability. *J. Appl. Mech.* 1951:18, 293-297.
- (35) Yashin AI, Vaupel JW, Iachine IA. A duality in aging: the equivalence of mortality models based on radically different concepts. *Mech Ageing Dev* 1994;74(1-2):1-14.

General discussion and synopsis Part B

In model organisms, there are various examples of interventions which extend average and maximal lifespan, but when expressed on a semi-log scale the age specific mortality trajectories have shifted parallel when compared to the control strains. The classical interpretation of the parameters of the Gompertz model is that the senescence rate in these model organisms has not been influenced positively. In **chapter 12** we have proposed the tangent line of the Gompertz equation as an alternative method for assessment of the rate of senescence. Such an approach unmasks different rates of senescence when parameter G has remained constant. In **chapter 13** we have empirically tested this new approach in a population of renal patients, a population known to experience accelerated aging. This study showed that using the derivative function of the Gompertz curve identifies different rates of senescence under various conditions. In contrast to the parameter G of the Gompertz curve which failed to detect these differences. To estimate the rate of senescence we therefore recommend using the derivative of the Gompertz equation.

Part C

APPENDICES



Deel A: Over de hormonale en metabole kenmerken van familiere langlevendheid: de Leiden Lang Leven Studie

De afgelopen twee eeuwen is de levensverwachting wereldwijd sterk toegenomen. Echter niet alle gewonnen levensjaren worden in goede gezondheid doorgebracht. Het vinden van eventuele aanknopingspunten voor interventies is nodig om ouderdomsziekten en achteruitgang in het functioneren te voorkomen. Er bestaat overtuigend bewijs dat langlevendheid vaker voorkomt in bepaalde families. Dit suggereert een genetische basis voor langlevendheid. Op zoek naar de biologie achter gezonde veroudering bestuderen wij daarom in de Leiden Langleven Studie de fenotypes van uitzonderlijk langlevende families. In dit hoofdstuk geven we een samenvatting van de belangrijkste hormonale en metabole kenmerken van familiere langlevendheid.

Ziekte en sterfte

Eerdere studies hebben laten zien dat familiere factoren een belangrijke rol spelen bij het bereiken van een hoge leeftijd ¹. Ook in Leiden Langleven Studie hebben langlevende families een opmerkelijk overlevingsvoordeel van 30% in vergelijking met de algemene bevolking (**hoofdstuk 2**). Het lagere sterfterisico is niet alleen aanwezig in broer- of zusparen van negentig jaar of ouder, maar ook in de eerstegraads familieleden van deze paren ^{2,3}. Het feit dat dit overlevingsvoordeel aantoonbaar is tot in de hoogste leeftijdscategorieën, suggereert de betrokkenheid van genetische factoren. De omgevingsfactoren die op jonge leeftijd gelijk zijn voor de leden van een broer- en zuspaar, zullen met het ouder worden immers sterk gaan verschillen ⁴.

Een andere belangrijke indicator van uitgestelde veroudering is, behalve sterfte, de hogere leeftijd waarop verouderingsziekten optreden ⁵. De incidentie van ziekten neemt toe met de leeftijd en ziekten zijn een belangrijke oorzaak voor sterfte ⁶. Wij hebben gevonden dat de kinderen van deelnemers van negentig jaar en ouder een aanzienlijk kleinere kans hebben op een myoinfarct, hypertensie en vooral diabetes mellitus type II (**hoofdstuk 2**) ². Onze uitkomsten komen overeen met eerdere studies waarin werd aangetoond dat kinderen van ouders die een uitzonderlijke hoge leeftijd hebben bereikt een lagere ziekte prevalentie hadden dan kinderen van ouders die op jongere leeftijd waren overleden ^{7,8}. Echter, in deze eerdere studies waren er significante verschillen in cardiovasculaire risicofactoren tussen de groepen, waaronder aantal jaren educatie en rookgedrag. Het exacte aandeel van genetica, gedrag en leefstijl bleef daarom lastig te bepalen. Aangezien honderdjarigen er over het algemeen gezonde levenswijzen op na houden, kunnen hun kinderen dit gedrag hebben overgenomen ⁹. Om mogelijke *confounding* door verschillen in omgevingsfactoren uit te sluiten, hebben wij de kinderen van langlevende personen vergeleken

met hun partners in de Leiden Langleven Studie. Aangezien kinderen en hun partners merendeels blootstaan aan de zelfde omgevingsfactoren, namen wij aan dat eventuele verschillen tussen beide groepen niet konden worden verklaard door verschillen in omgevingsfactoren. Inderdaad waren de belangrijkste maten voor leefstijl gelijk voor beide groepen, zoals de geschatte BMI, huidige rookgedrag en het daaraan gerelateerde vóórkomen van COPD. Hieruit volgt dat eventuele verschillen in gezondheidstoestand tussen beide groepen eerder verklaard moeten worden uit (epi)genetische factoren dan uit omgevingsfactoren ^{2;10}.

Wij hebben geen verschil gevonden in het vóórkomen van kanker noch de sterfte door kanker tussen de kinderen en hun partners. Deze uitkomst komt niet overeen met eerder onderzoek waaruit bleek dat kinderen van honderdjarigen een lagere kans hadden om te sterven aan kanker in vergelijking met controles ¹¹. Dit verschil kan misschien verklaard worden door een leeftijdsverschil: de deelnemers in de Leiden Langleven Studie zijn gemiddeld ongeveer tien jaar jonger dan de deelnemers uit voornoemde studie.

IGF/ insuline signaaltransductie

De invloed van de evolutionair geconserveerde insuline/ insulin-like growth factor (IGF-1) signaaltransductie (IIS) route op veroudering is uitvoerig beschreven in wormen ¹², fruitvliegen ¹³ en knaagdieren ^{14;15}. Genetische mutaties die de IIS gedeeltelijk remmen, verlengen de levensduur van deze organismen en vooral bij het vrouwelijk geslacht. Ongewervelde organismen hebben een enkele insuline/IGF-1 receptor, waaraan verscheidene liganden binden. Zoogdieren hebben aparte receptoren ontwikkeld voor insuline en IGF-1 met gedeeltelijk overlappende functies. IGF-1 is betrokken bij groei terwijl insuline de stofwisseling stuurt ¹⁶.

Het belangrijkste kenmerk dat langlevende zoogdieren delen met langlevende mutanten ¹⁷ waaronder de mutanten met geïnduceerde IGF resistentie, is insuline gevoeligheid en lage nuchtere bloedsuikerspiegels. Insuline gevoeligheid is ook nauw gerelateerd met een lager sterfte risico in zoogdieren tijdens caloriebeperking. De bevindingen in de Leiden Langleven Studie suggereren dat insuline gevoeligheid ook een rol speelt bij langlevendheid in de mens.

Ten eerste hebben de kinderen van negentigjarigen relatief lagere bloedsuikergehaltes en bloedinsulinegehalten (**hoofdstuk 7**) ¹⁸. Daarnaast hebben zij een gunstiger glucose tolerantie zoals blijkt uit de orale glucose tolerantietest (**hoofdstuk 3**) ¹⁰. Voorlopige gegevens suggereren dat dit fenotype ook aanwezig is in de hoogste leeftijdscategorieën (**figuur 1**). Opmerkelijk genoeg, vonden wij tussen de studiepopulaties geen verschillen in de klassieke risicofactoren voor insuline-resistentie zoals lichaamsbeweging, voedingsgewoontes, subklinische ontsteking (**hoofdstuk 5**). Ten tweede, kwam in de groep kinderen van negentigjarigen minder vaak het

metabool syndroom voor (**hoofdstuk 3**)¹⁰, een combinatie van cardiovasculaire risicofactoren waaraan mogelijk insulineresistentie ten grondslag ligt. Als we kijken naar de verschillende onderdelen van het metabool syndroom, bevatte de groep kinderen van de negentigjarigen minder personen met een laag HDL en minder personen met een gestoorde nuchtere bloedsuikergehalte. Het aantal personen dat voldeed aan obesitas gerelateerde criteria, waaronder buikomtrek en nuchtere triglyceridewaarde, verschilde niet tussen de twee groepen. Ten slotte, waren de kinderen van negentigjarigen gevoeliger voor insuline. Deze insulinegevoeligheid uitte zich in een versnelde perifere glucoseopname zoals gemeten tijdens een hyperinsulinemische euglycemische clampstudie (**hoofdstuk 4**). De hyperinsulinemische euglycemische clampstudie geldt als de gouden standaard voor het bepalen van insuline gevoeligheid. Aan de hand van deze methode stelden wij vast dat het effect van insuline op de suikerstofwisseling en met name de glucoseopname kinderen van langlevende ouders onderscheidt van controles. Het effect van insuline op de onderdrukking van glucoseproductie of lipolyse speelt hierbij een ondergeschikte rol. Het gevonden effect van insuline op de perifere glucoseopname strookt met eerdere onderzoeken naar de pathofysiologie van diabetes mellitus II. Perifere insuline ongevoeligheid wordt beschouwd als één van de eerste stadia in de ontwikkeling van diabetes^{19;20}, en is al tientallen jaren aanwezig voordat de ziekte zich openbaart^{21;22}. onderdrukking van de glucoseproductie in de lever is een gevolg van vetopstapeling in de lever²³, en betreft een laat stadium in de ontwikkeling van diabetes 20.

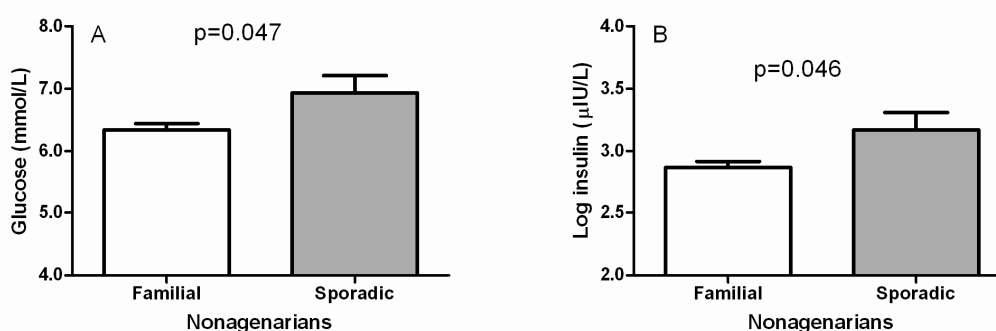

Figuur 1. Niet nuchter bloedsuikergehalte (A) en logaritmische bloedinsulinegehaltenes (B) in familiale negentigjarigen (N=333) en sporadische negentigjarigen (N=49), negentigjarigen zonder negentigjarige zus of broer. Om eventuele verschillen in gezondheidstoestand tussen de twee groepen uit te sluiten, zijn alleen negentigjarigen uit het hoogste tertiel van ADL scores (Activiteiten van het Dagelijks Leven) geïncludeerd. De staven stellen de gemiddelde bloedgehaltenes voor met de standaardfout van het gemiddelde gecorrigeerd voor leeftijd en geslacht.

Onze bevindingen komen overeen met eerdere onderzoeken die aantoonen dat kinderen van uitzonderlijk langlevende ouders beschermd zijn tegen cardiovasculaire aandoeningen^{11;24;25}. Eerder werd al aangetoond dat kinderen van langlevende ouders in veel opzichten gezonder zijn: kinderen van langlevende ouders hadden bijvoorbeeld een gunstiger lipidenprofiel^{26;27;28}. Wat betreft de suikerstofwisseling was dit nog niet aangetoond. Terwijl insuline gevoeligheid gewoonlijk afneemt met de leeftijd, blijken honderdjarigen een insuline gevoeligheid te hebben die vergelijkbaar is met die van jong volwassenen²⁹. Onze resultaten vormen een aanvulling op deze eerdere observaties door te laten zien dat in langlevende families de gunstige suikerstofwisseling al op middelbare leeftijd aanwezig is.

Behalve behoud van insulinegevoeligheid is uitzonderlijke langlevendheid bij mensen waarschijnlijk ook geassocieerd met een onderdrukking van de IGF-1 signaal transductie. Onlangs is aangetoond dat in honderdjarigen vaker bepaalde zeldzame genetische varianten van de IGF-1 receptor voorkomen die gepaard gaan met een hogere IGF-1/IGFBP-3 ratio en met een lagere IGF-1 signaal transductie³⁰. Eerder is al aangetoond dat veelvoorkomende genetische variaties met betrekking tot de IGF-1 signaal transductie mogelijk bijdragen aan de verschillen in sterfte in de algemene bevolking^{30;31}. Wij vonden ook voorlopige aanwijzingen dat verminderde IGF-1 signaal transductie betrokken is bij familiare langlevendheid. Wij maten lagere IGF-1 gehalten bij negentigjarige vrouwen wier ouders een uitzonderlijk hoge leeftijd hebben bereikt in vergelijking met negentigjarigen wier ouders op jongere leeftijd waren overleden (**hoofdstuk 7**). Een ander belangrijk kenmerk van een levenslang onderdrukte IGF-1 signaal transductie in zowel mensen als modelorganismes is de relatief kleinere lengte. In overeenstemming hiermee waren negentigjarigen wier ouders uitzonderlijk oud werden doorgaans kleiner dan controles wier ouders jonger overleden.

De resultaten in de groep negentigjarigen wijken af van de bevindingen in de groep kinderen (**hoofdstuk 6**). Wij vonden geen significante verschillen in IGF-1 bloedspiegels noch verschillen in lengte tussen de kinderen en hun partners¹⁸. Daarnaast waren de groeihormoon gehalten in het bloed na één nacht vasten gelijk tussen de twee groepen (**tabel 1**). Deze tegenstrijdige resultaten kunnen misschien verklaard worden door een leeftijdsverschil. De geschatte bijdrage van genetische factoren aan langlevendheid is bescheiden (20-30%) maar neemt toe met de leeftijd. Daarom is het mogelijk dat het effect van genetische variabiliteit in de IIS pas op latere leeftijd merkbaar wordt. De associatie tussen *FOXO3A* en langlevendheid was bijvoorbeeld sterker in honderdjarigen dan in negentigjarigen³². Een andere mogelijke verklaring zijn verschillen in imprinting van het IGF-1 gen, mogelijk ten gevolge van historische verschillen in voeding tussen de twee generaties^{30;33}.

Tabel 1. Nuchtere, hormonale serum waarden voor kinderen en partners

	Kinderen	Partners	P-waarde
Deelnemers (N)	121	113	
Vrouwen (N, %)	62 (51.2%)	59 (48.8%)	0.90
TSH (mU/L)	2.41 (1.93 - 3.06)	1.69 (1.33 - 2.15)	0.029
Vrij T4 (pmol/L)	16.2 (15.8 - 16.6)	16.4 (16.0 - 16.9)	0.49
Vrij T3 (pmol/L)	5.03 (4.87 - 5.20)	5.26 (5.09 - 5.44)	0.045
Groei hormoon (mU/L)	1.90 (1.50 - 2.40)	2.02 (1.58 - 2.57)	0.72
IGF-1 (nmol/L)	15.3 (14.3 - 16.2)	15.0 (14.1 - 16.0)	0.71
IGFBP3 (mg/L)	4.03 (3.85 - 4.21)	3.98 (3.79 - 4.16)	0.63
Cortisol (µmol/L)	0.49 (0.47 - 0.52)	0.52 (0.49 - 0.55)	0.22
Prolactine (U/L)	10.1 (9.28 - 10.9)	10.3 (9.51 - 11.2)	0.64
HsCRP (mg/dL)	1.29 (1.17 - 1.60)	1.17 (0.93 - 1.46)	0.45

Data zijn weergegeven als gemiddelde waarden met een 95% betrouwbaarheidsinterval. TSH, groeihormoon and high-sensitivity C-reactive protein (hsCRP) zijn weergegeven als geometrisch gemiddelde met een 95% betrouwbaarheidsinterval. Serum is afgenomen om 9:00 – 09:30 in de ochtend. Data zijn gecorrigeerd voor leeftijd en geslacht.

Schildklierfunctie

De hypothalamus-hypofyse-schildklier-as speelt waarschijnlijk een zeer belangrijke rol in het verouderingsproces³⁴. Het levensverlengend effect van een lager schildklierhormoongehalte is beschreven in verschillende diersmodellen. Het veroorzaken van hypothyreoïdie bij neonatale ratten heeft een lichte toename van de levensduur tot gevolg³⁵. Lage schildklierhormoonspiegels zijn bovendien kenmerkend voor langlevende muismodellen met mutaties in de hypofyse. De langlevende Ames- en Sneldwergmuizen vertonen kenmerken die waarschijnlijk te maken hebben met schildklierhormoon tekort³⁶. In proefpersonen van vijfentachtig jaar en ouder zijn hogere thyrotropinespiegels gerelateerd met een overlevingsvoordeel zonder gevolgen voor het functioneren of de stemming^{37;38}.

Ook in de Leiden Langleven Studie vonden we een relatie tussen vertraagde schildklierfunctie en toegenomen levensduur. Negentigjarige kinderen van ouders die een uitzonderlijk hoge leeftijd hebben bereikt, hadden hogere thyrotropinespiegels, lagere thyroxinespiegels en lagere

triiodothyroninespiegels in vergelijking met negentigjarigen wier ouders op jongere leeftijd overleden (**hoofdstuk 9**)³⁹. De tragere schildklierfunctie in negentigjarigen was ook aantoonbaar in de kinderen van middelbare leeftijd. De kinderen van middelbare leeftijd hadden lagere perifere schilklhormoonspiegels en neigden tot hogere thyrotropinespiegels in vergelijking met hun partners onder nuchtere (**hoofdstuk 8**)⁴⁰ en niet-nuchtere omstandigheden (**tabel 1**). Deze observaties suggereren dat een verminderde activiteit van schildklieras een overerfbaar fenotype is dat bijdraagt aan buitengewone langlevendheid.

Verminderde activiteit van de schildklieras is mogelijk een manier om energiebesteding te herverdelen van groei en proliferatie naar onderhoud. Schildklierhormonen regelen in de eerste plaats het basaal metabolisme van cellen en zodoende de aanmaak van warmte en vrije radicalen⁴¹. Studies in modelorganismen laten zien dat lagere triiodothyroninespiegels geassocieerd zijn met verminderde aanmaak van zuurstofradicalen⁴². Efficiënter transport van elektronen via het mitochondrieel membraan bij een lager schildklierhormoongehalte vermindert mogelijk de aanmaak van zuurstofradicalen en vertraagt zo het verouderingsproces.

Onze studie liet lagere schildklierspiegels zien in personen uit langlevende families. Het vóórkomen van subklinische hypothyreoïdie en subklinische hyperthyreoïdie neemt snel toe met de leeftijd⁴³. De precieze definitie van subklinische hypothyreoïdie en de noodzaak om leeftijds specifieke normaalwaarden te ontwikkelen voor thyrotropine is momenteel punt van discussie.

Thyrotropinespiegels stijgen geleidelijk met de leeftijd. Recentelijk is aangetoond dat deze stijging zich voortzet tot in de hoogste leeftijdscategorieën⁴⁴. De hogere thyrotropinespiegels op oudere leeftijd zijn mogelijk het resultaat van selectieve overleving van individuen met een aangeboren tragere schildklierfunctie³⁷. Daarnaast kan een verandering in de schildklierfunctie met de leeftijd enerzijds het gevolg zijn van een opeenstapeling van schade. Anderzijds kunnen afwijkingen in de schildklierfunctie onderdeel zijn van een adaptief mechanisme in weerwoord op verzamelde schade om zo verdere pathologie te beperken. De huidige aanbeveling luidt om bij ouderen met subklinische hypothyreoïdie schildklierhormoon te suppleren. In het licht van voorgaande overwegingen blijft de behandeling van de leeftijdsgerelateerde hormonale afwijkingen echter omstreden. Hoewel pathologische afwijkingen baat zouden hebben bij behandeling, geldt dit niet voor een aangeboren vertraagde schildklierfunctie of voor afwijkingen die onderdeel uitmaken van een adaptieve respons.

Behalve een stijging in de thyrotropinwaarden doen zich met de leeftijd andere veranderingen voor in de schildklieras. In **hoofdstuk 10** laten wij een wederzijds verband zien tussen serum triiodothyroninespiegels en serum inflammatoire cytokines. Hoge spiegels van inflammatoire cytokines zijn geassocieerd met lagere vrije triiodothyroninespiegels. Dit suggereert dat bij inflammatie, de activiteit van de schildklieras wordt geremd. Dit gebeurt mogelijk door een verminderde conversie van thyroxine naar triiodothyronine.

Conclusie

Terwijl de gemiddelde levensverwachting blijft stijgen, nemen ook het aantal jaren dat in slechte gezondheid wordt doorgebracht toe. Het vinden van mogelijke aangrijpingspunten voor interventies is noodzakelijk om leeftijdsgerelateerde aandoeningen en achteruitgang van functioneren tegen te gaan. Bestudering van het fenotype bij mensen die gepredisponeerd zijn voor een langer leven kan hiervoor aanwijzingen bieden. Als we aannemen dat de eigenschappen die leiden tot een langer leven overerfbaar zijn, dan kunnen de kinderen van uitzonderlijk langlevende ouders een oplossing bieden bij de zoektocht naar succesvolle veroudering.

Referenties

- (1) Perls TT, Wilmoth J, Levenson R et al. Life-long sustained mortality advantage of siblings of centenarians. *Proc Natl Acad Sci U S A* 2002;99:8442-8447.
- (2) Westendorp RG, van Heemst D, Rozing MP et al. Nonagenarian siblings and their offspring display lower risk of mortality and morbidity than sporadic nonagenarians: The Leiden Longevity Study. *J Am Geriatr Soc* 2009;57:1634-1637.
- (3) Schoenmaker M, de Craen AJ, de Meijer PH et al. Evidence of genetic enrichment for exceptional survival using a family approach: the Leiden Longevity Study. *Eur J Hum Genet* 2006;14:79-84.
- (4) Perls T, Terry D. Understanding the determinants of exceptional longevity. *Ann Intern Med* 2003;139:445-449.
- (5) Colman RJ, Anderson RM, Johnson SC et al. Caloric restriction delays disease onset and mortality in rhesus monkeys. *Science* 2009;325:201-204.
- (6) Vita AJ, Terry RB, Hubert HB, Fries JF. Aging, health risks, and cumulative disability. *N Engl J Med* 1998;338:1035-1041.
- (7) Terry DF, Wilcox MA, McCormick MA et al. Lower all-cause, cardiovascular, and cancer mortality in centenarians' offspring. *J Am Geriatr Soc* 2004;52:2074-2076.
- (8) Terry DF, Wilcox MA, McCormick MA, Perls TT. Cardiovascular disease delay in centenarian offspring. *J Gerontol A Biol Sci Med Sci* 2004;59:385-389.
- (9) Galioto A, Dominguez LJ, Pineo A et al. Cardiovascular risk factors in centenarians. *Exp Gerontol* 2008;43:106-113.
- (10) Rozing MP, Westendorp RG, de Craen AJ et al. Favorable glucose tolerance and lower prevalence of metabolic syndrome in offspring without diabetes mellitus of nonagenarian siblings: the Leiden longevity study. *J Am Geriatr Soc* 2010;58:564-569.
- (11) Terry DF, Wilcox MA, McCormick MA et al. Lower all-cause, cardiovascular, and cancer mortality in centenarians' offspring. *J Am Geriatr Soc* 2004;52:2074-2076.
- (12) Kenyon C, Chang J, Gensch E, Rudner A, Tabtiang R. A *C. elegans* mutant that lives twice as long as wild type. *Nature* 1993;366:461-464.

- (13) Tatar M, Kopelman A, Epstein D, Tu MP, Yin CM, Garofalo RS. A mutant *Drosophila* insulin receptor homolog that extends life-span and impairs neuroendocrine function. *Science* 2001;292:107-110.
- (14) Brown-Borg HM, Borg KE, Meliska CJ, Bartke A. Dwarf mice and the ageing process. *Nature* 1996;384:33.
- (15) Holzenberger M, Dupont J, Ducos B et al. IGF-1 receptor regulates lifespan and resistance to oxidative stress in mice. *Nature* 2003;421:182-187.
- (16) Russell SJ, Kahn CR. Endocrine regulation of ageing. *Nat Rev Mol Cell Biol* 2007;8:681-691.
- (17) Longo VD, Finch CE. Evolutionary medicine: from dwarf model systems to healthy centenarians? *Science* 2003;299:1342-1346.
- (18) Rozing MP, Westendorp RG, Frolich M et al. Human insulin/IGF-1 and familial longevity at middle age. *Aging (Albany NY)* 2009;1:714-722.
- (19) DeFronzo RA, Bonadonna RC, Ferrannini E. Pathogenesis of NIDDM. A balanced overview. *Diabetes Care* 1992;15:318-368.
- (20) Taylor R. Pathogenesis of type 2 diabetes: tracing the reverse route from cure to cause. *Diabetologia* 2008;51:1781-1789.
- (21) Lillioja S, Mott DM, Howard BV et al. Impaired glucose tolerance as a disorder of insulin action. Longitudinal and cross-sectional studies in Pima Indians. *N Engl J Med* 1988;318:1217-1225.
- (22) Lillioja S, Mott DM, Spraul M et al. Insulin resistance and insulin secretory dysfunction as precursors of non-insulin-dependent diabetes mellitus. Prospective studies of Pima Indians. *N Engl J Med* 1993;329:1988-1992.
- (23) Seppala-Lindroos A, Vehkavaara S, Hakkinen AM et al. Fat accumulation in the liver is associated with defects in insulin suppression of glucose production and serum free fatty acids independent of obesity in normal men. *J Clin Endocrinol Metab* 2002;87:3023-3028.
- (24) Atzmon G, Schechter C, Greiner W, Davidson D, Rennert G, Barzilai N. Clinical phenotype of families with longevity. *J Am Geriatr Soc* 2004;52:274-277.

Appendix A

- (25) Terry DF, Wilcox MA, McCormick MA, Perls TT. Cardiovascular disease delay in centenarian offspring. *J Gerontol A Biol Sci Med Sci* 2004;59:385-389.
- (26) Barzilai N, Atzmon G, Schechter C et al. Unique lipoprotein phenotype and genotype associated with exceptional longevity. *JAMA* 2003;290:2030-2040.
- (27) Heijmans BT, Beekman M, Houwing-Duistermaat JJ et al. Lipoprotein particle profiles mark familial and sporadic human longevity. *PLoS Med* 2006;3:e495.
- (28) Atzmon G, Pollin TI, Crandall J et al. Adiponectin levels and genotype: a potential regulator of life span in humans. *J Gerontol A Biol Sci Med Sci* 2008;63:447-453.
- (29) Paolisso G, Gambardella A, Ammendola S et al. Glucose tolerance and insulin action in healthy centenarians. *Am J Physiol* 1996;270:E890-E894.
- (30) Suh Y, Atzmon G, Cho MO et al. Functionally significant insulin-like growth factor I receptor mutations in centenarians. *Proc Natl Acad Sci U S A* 2008;105:3438-3442.
- (31) van HD, Beekman M, Mooijaart SP et al. Reduced insulin/IGF-1 signalling and human longevity. *Aging Cell* 2005;4:79-85.
- (32) Flachsbart F, Caliebe A, Kleindorp R et al. Association of FOXO3A variation with human longevity confirmed in German centenarians. *Proc Natl Acad Sci U S A* 2009;106:2700-2705.
- (33) Drake NM, Park YJ, Shirali AS, Cleland TA, Soloway PD. Imprint switch mutations at *Rasgrf1* support conflict hypothesis of imprinting and define a growth control mechanism upstream of IGF1. *Mamm Genome* 2009;20:654-663.
- (34) Brown-Borg HM. Hormonal regulation of longevity in mammals. *Ageing Res Rev* 2007;6:28-45.
- (35) Ooka H, Fujita S, Yoshimoto E. Pituitary-thyroid activity and longevity in neonatally thyroxine-treated rats. *Mech Ageing Dev* 1983;22:113-120.
- (36) Tatar M, Bartke A, Antebi A. The endocrine regulation of aging by insulin-like signals. *Science* 2003;299:1346-1351.

- (37) Atzmon G, Barzilai N, Hollowell JG, Surks MI, Gabriely I. Extreme longevity is associated with increased serum thyrotropin. *J Clin Endocrinol Metab* 2009;94:1251-1254.
- (38) Gussekloo J, van EE, de Craen AJ, Meinders AE, Frolich M, Westendorp RG. Thyroid status, disability and cognitive function, and survival in old age. *JAMA* 2004;292:2591-2599.
- (39) Rozing MP, Houwing-Duistermaat JJ, Slagboom PE et al. Familial longevity is associated with decreased thyroid function. *J Clin Endocrinol Metab*. In press.
- (40) Rozing MP, Westendorp RG, de Craen AJ et al. Low serum free triiodothyronine levels mark familial longevity: the Leiden Longevity Study. *J Gerontol A Biol Sci Med Sci* 2010;65:365-368.
- (41) Harper ME, Seifert EL. Thyroid hormone effects on mitochondrial energetics. *Thyroid* 2008;18:145-156.
- (42) Lopez-Torres M, Romero M, Barja G. Effect of thyroid hormones on mitochondrial oxygen free radical production and DNA oxidative damage in the rat heart. *Mol Cell Endocrinol* 2000;168:127-134.
- (43) Mariotti S, Franceschi C, Cossarizza A, Pinchera A. The aging thyroid. *Endocr Rev* 1995;16:686-715.
- (44) Hollowell JG, Staehling NW, Flanders WD et al. Serum TSH, T(4), and thyroid antibodies in the United States population (1988 to 1994): National Health and Nutrition Examination Survey (NHANES III). *J Clin Endocrinol Metab* 2002;87:489-499.

Deel B: over het bepalen van de snelheid van veroudering

Verschillende experimenten in modelorganismen laten een verlenging in de gemiddelde en maximale levensduur zien. Wanneer de overlevingscurve echter wordt weergegeven op een semilogaritmische schaal, blijkt deze parallel te zijn verschoven ten opzichte van de overlevingscurve van de controlegroep. De gangbare interpretatie van de Gompertz parameters is dat de snelheid van veroudering hiermee niet positief is beïnvloed. In **hoofdstuk 12** stellen wij de raaklijn aan de overlevingscurve voor als een alternatief voor het bepalen van de snelheid van veroudering. Deze benadering levert verschillende snelheden van veroudering op bij een constante parameter G . In **hoofdstuk 13** hebben wij de deze benadering empirisch getoetst in een populatie van nierpatiënten, een populatie patiënten die versneld verouderen. Afschatting van de snelheid van veroudering aan de hand van de eerste afgeleide van de Gompertz curve, laat onder wisselende omstandigheden verschillende snelheden van veroudering zien, in tegenstelling tot gebruik van parameter G als benadering voor de verouderingsnelheid, waarbij de snelheid van veroudering constant blijft. Bij bepaling van de snelheid van veroudering raden wij daarom de eerste afgeleide van de Gompertz curve aan.

Appendix C: Acknowledgements

This thesis is largely based on data from the Leiden Longevity Study and the Leiden 85- plus Study. I am greatly indebted to the participants in these studies. Invaluable was the assistance of the secretary and nursing staff of the Department of Gerontology and Geriatrics at Leiden University Medical Centre, as well as the cooperation of the pharmacists and general practitioners.

Appendix D: Curriculum vitae

Maarten Pieter Rozing was born on June 1st, 1979 in Leiderdorp, the Netherlands. He was admitted to the young talent class at the Royal Conservatoire in The Hague in 1995. In 1997 he graduated at the Lyceum Visser 't Hooft in Leiden, the Netherlands. Thereafter he studied classical piano at the Royal Conservatoire in The Hague, the Netherlands (BA 2003), Slavonic languages and cultures (MA 2007), and medicine at the University of Leiden, the Netherlands (MA 2005, MD 2008). From 2008 onwards he followed a PhD program at the Department of Gerontology and Geriatrics at the Leiden University Medical Center. From September 2010 he worked as a Senior House Officer (Dutch: ANIOS) at the GGZinGeest, Buitenamstel in Amsterdam, the Netherlands. In April 2011 he started his specialist training in Psychiatry at GGZinGeest, Geestgronden, in Amstelveen, the Netherlands and the Vrije Universiteit Medical Center, Amsterdam.

Appendix E: List of publications

1. Rozing MP, Westendorp RGJ. *Parallel lines: nothing has changed?* Aging Cell 2008 December; 7(6):924-7.
2. Rozing MP, Westendorp RGJ, Frölich M, de Craen AJM, Beekman M, Heijmans BT, Mooijaart SP, Blauw GJ, Slagboom PE, van Heemst D. *Human insulin/IGF-1 and familial longevity at middle age.* Aging (Albany NY) 2009 July;1(8):714-722.
3. Westendorp RGJ, van Heemst D, Rozing MP, Frölich M, Mooijaart SP, Blauw GJ, Beekman M, Heijmans BT, de Craen AJM, Slagboom PE. *Endocrine regulation of familial longevity.* J Am Geriatr Soc 2009 September;57(9):1634-1637.
4. van Bodegom D, Rozing M, May L, Kuningas M, Thomese F, Meij H, Westendorp RGJ. *When grandmothers matter.* Gerontology 2010 February;56(2):214-216.
5. Rozing MP, Westendorp RGJ, de Craen AJM, Frölich M, de Goeij MC, Heijmans BT, Beekman M, Wijsman CA, Mooijaart SP, Blauw GJ, Slagboom PE, van Heemst D. *Favorable glucose tolerance and lower prevalence of metabolic syndrome in offspring without diabetes mellitus of nonagenarian siblings: the Leiden longevity study.* J Am Geriatr Soc. 2010 March;58(3):564-569.
6. Rozing MP, Westendorp RGJ, de Craen AJM, Frölich M, Heijmans BT, Beekman M, Wijsman CA, Mooijaart SP, Blauw GJ, Slagboom PE, van Heemst D. *Low serum free triiodothyronine levels mark familial longevity: the Leiden Longevity Study.* J Gerontol A Biol Sci Med Sci. 2010 April;65(4):365-8.
7. Rozing PM, Nagels J, Rozing MP. Prognostic factors in arthroplasty in the rheumtoid shoulder. *HSS journal* 2010 July;(7):1-8.
8. Rozing MP, van Heemst D. *Author reply: Thyrotropin serum values and 3-year mortality in nonagenarians.* J Gerontol A Biol Sci Med Sci. 2010 November;65(11):1252-3.

Appendix E

9. Rozing M, Houwing-Duistermaat JJ, Slagboom PE, Beekman M, Frölich M, de Craen AJM, Westendorp RGJ, van Heemst D. *Familial longevity is associated with decreased thyroid function*. JCEM 2010 November;11(95):4979-4984.
10. Rozing MP, Mooijaart SP, Beekman M, Wijsman CA, Maier AB, Bartke A, Westendorp RG, Slagboom EP, van Heemst D. *C-reactive protein and glucose regulation in familial longevity*. Age (Dordr) 2011 January 19. (Epub ahead of print)
11. Mooijaart SP, van Heemst D, Noordam R, Rozing MP, Wijsman CA, de Craen AJ, Westendorp RG, Beekman M, Slagboom PE. *Polymorphisms associated with type 2 diabetes in familial longevity: The Leiden Longevity Study*. Aging (Albany NY) 2011 January;3(1):55-62.
12. Slagboom PE, Beekman M, Passtoors WM, Deelen J, Vaarhorst AA, Boer JM, van den Akker EB, van Heemst D, de Craen AJ, Maier AB, Rozing M, Mooijaart SP, Heijmans BT, Westendorp RG. *Genomics of human longevity*. Philos Trans R Soc Lond B Biol Sci. 2011 January 12;366(1561):35-42.
13. Wijsman CA*, Rozing MP*, , Streefland TC, Le Cessie S, Mooijaart SP, Slagboom PE, Westendorp RGJ, Pijl H, van Heemst D. *Familial longevity is marked by enhanced insulin sensitivity*. Aging Cell 2011 February; 10(1):114-121 (* shared first authorship)
14. Rozing MP, Westendorp RG, Maier AB, Wijsman CA, Frölich M, de Craen AJ, van Heemst D. *Serum triiodothyronine levels and inflammatory cytokine production capacity*. Age (Dordr) 2011 February 25 (Epub ahead of print)
15. Wijsman CA, van Heemst D, Rozing MP, Slagboom PE, Beekman M, de Craen AJ, Maier AB, Westendorp RG, Blom HJ, Mooijaart SP. *Homocysteine and familial longevity: the Leiden Longevity Study*. PLoS One 2011 March;6(3):e17543.
16. Koopman JJ, Rozing MP, Kramer A, de Jager DJ, Ansell D, de Meester JM, Prütz KG, Finne P, Heaf JG, Palsson R, Kramar R, Jager KJ, Dekker FW, Westendorp RGJ, Senescence rates in patients with end-stage renal disease: a critical appraisal of the Gompertz model, Aging Cell 2011 April;10(2):233-238.

17. Rozing MP, The nightmare of Ivan Fyodorovich, Analysis and interpretation of a chapter from Dostoyevsky's *The Brothers Karamazov*. *Nederlands tijdschrift voor Slavistiek* 2008 December;51;19-36.