



Universiteit
Leiden
The Netherlands

Linear polarization of the galactic background at 50 cm

Berkhuijsen, E.M.; Brouw, W.N.; Muller, C.A.; Tinbergen, J.

Citation

Berkhuijsen, E. M., Brouw, W. N., Muller, C. A., & Tinbergen, J. (1964). Linear polarization of the galactic background at 50 cm. *Bulletin Of The Astronomical Institutes Of The Netherlands*, 17, 465. Retrieved from <https://hdl.handle.net/1887/5578>

Version: Not Applicable (or Unknown)

License: [Leiden University Non-exclusive license](#)

Downloaded from: <https://hdl.handle.net/1887/5578>

Note: To cite this publication please use the final published version (if applicable).

LINEAR POLARIZATION OF THE GALACTIC BACKGROUND AT 50 CM

ELLY M. BERKHUIJSEN, W. N. BROUW, C. A. MULLER and J. TINBERGEN

Received June 29, 1964

A polarization survey of most of the northern sky at 610 Mc/s is presented. The results are compared with those obtained earlier at 408 Mc/s. Two regions stand out at both these frequencies. At 610 Mc/s the general appearance of these regions is more regular than at 408 Mc/s. Around $l^{\text{II}} = 140^\circ$ the intensity of the polarized radiation is relatively large, while the Faraday rotation is relatively small in most of this region. The structure of the area around $l^{\text{II}} = 140^\circ$, $b^{\text{II}} = +6^\circ$ is particularly simple, and suggests a homogeneous magnetic field parallel to the galactic plane,

in general agreement with optical data. In the neighbourhood of $l^{\text{II}} = 15^\circ$, $b^{\text{II}} = +65^\circ$, part of the North Polar Spur, the apparent structure is more complicated, and no detailed conclusions can be drawn.

Through observations of the Faraday rotation, the sense of galactic magnetic fields is becoming an observable quantity. In one case so far the sense of a magnetic field at right angles to the line of sight may even be inferred with some confidence from the pattern of Faraday rotations.

1. Introduction

The discovery of linear polarization in the galactic background radiation at 408 Mc/s has led to a programme of surveys at several frequencies. In addition to the survey at 408 Mc/s (BERKHUIJSEN and BROUW, 1963), we now have results at 610 Mc/s, some of which have already been reported (MULLER *et al.*, 1963). The observations were made in June and November 1963 with the 25-metre radio telescope at Dwingeloo and a new receiver designed by C. A. Muller. The centre frequency was 610 Mc/s, the bandwidth 3.6 Mc/s, and the beam-width $1^\circ.4$.

A. Koeling built and maintained the receiver, and made the final adjustments to the feed. In carrying out the observations, the authors were assisted by student observers. The latter were supervised by S. Drenth, who also constructed the daily observing programmes. Reduction was speeded up considerably by the use of the Electrologica XI of the Computing Centre of Leiden University, programmed and operated by W. N. Brouw. The Netherlands Foundation for the Advancement of Pure Research (Z.W.O.) financially supported the programme.

The authors wish to thank Professor J. H. Oort for some valuable comments on an earlier form of this paper.

2. Equipment

A detailed description of the correlation receiver used in this investigation will be published in due course. At present only a summary and a block diagram of the instrument (figure 1) are given.

The feed, of the conical horn type, is similar to the one used in the 408 Mc/s survey (BERKHUIJSEN and BROUW, 1963). Inside the short section of circular waveguide, which feeds the horn, is mounted a rotating cylindrical box carrying the crossed dipole probes and their baluns. The connection between this box and the receiver inputs is made with short lengths of flexible coaxial cable incorporating rotary joints to prevent twisting of the cables during rotation. The coupling between the dipole probes has been reduced by careful adjustment to better than 55 db for all position angles of the dipole system.

The circulators, which are used as isolators, eliminate gain changes due to small changes of antenna impedance with rotation and reduce by at least 25 db the coupling for the crystal mixer noise between the two receivers via the dipole system. The effects of changes in the coupling between the dipoles during rotation, which without the circulators might lead to a small spurious polarization signal, are now completely negligible.

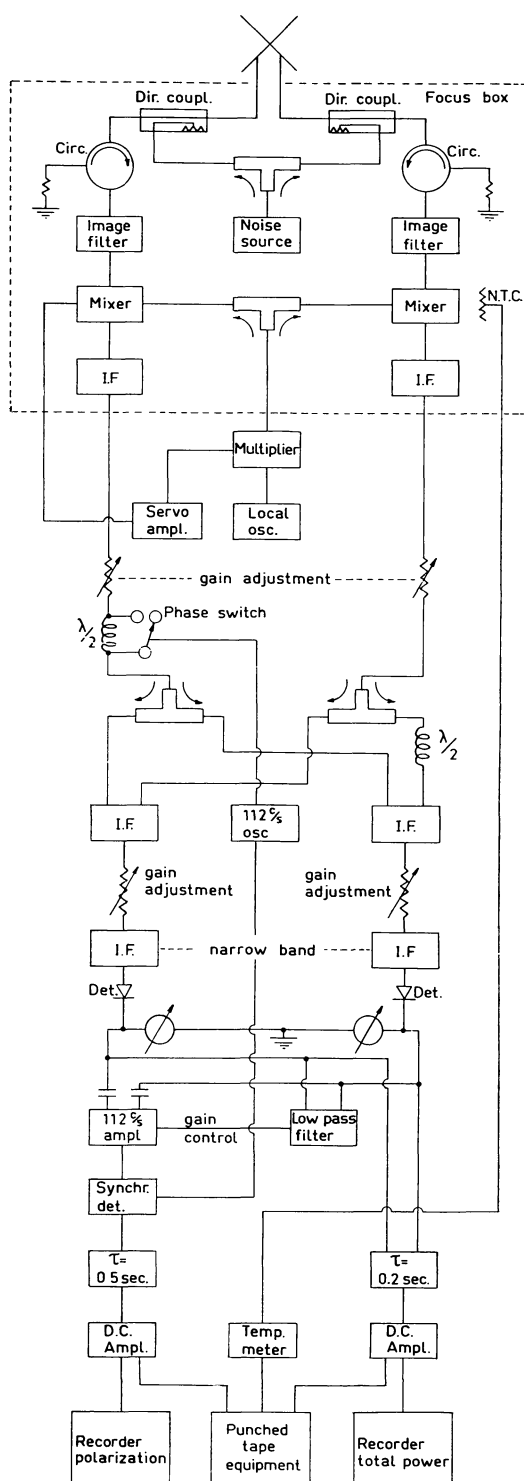

Figure 1. Block diagram of receiving system.

The image filters provide more than 80 db attenuation at the image frequency and 30 to 80 db at the second and third harmonic sideband frequencies. These large attenuations are desirable, since almost all manmade interference is strongly plane polarized and these frequencies fall outside the protected bands. Both mixers have loose capacitive coupling to equal lengths of cable, which are connected through a resistive power divider to the output of the crystal-controlled local oscillator multiplier chain. The coupling between the receivers over this common local oscillator circuit is about 60 db, and gives a small spurious correlated output, which, however, is constant during rotation of the dipole system and therefore is not interpreted as a polarized signal.

The local oscillator level at the mixers is held constant by a d.c. servo system on the crystal current of one of the mixers. After a few stages of i.f. amplification the signals are taken from the focus box, which houses all the equipment mentioned so far except the local oscillator units, to the observing cabin containing the rest of the receiver. The phase switch reverses the polarity of one of the signals at a rate of 112 c/s by inserting a half wavelength of cable in the connection between the front end and the add/subtract network. This network combines the signals from the two separate receiver front ends, in phase or out of phase, at the inputs of the two final i.f. amplifiers. The effects of the small amount of amplitude modulation caused by the phase switch are eliminated in this double i.f. system. The final i.f. amplifiers determine the bandwidths of the two channels; the preamplifiers have a wider bandwidth, ensuring that only small phase differences between the preamplifiers occur over the passband of the receiver as a whole.

The i.f. amplifiers are followed by linear diode detectors. In the polarization channel, where the combined 112 c/s signal of the two detector outputs is amplified before synchronous detection, an amplifier stage is used whose gain is proportional to the sum of the two d.c. detector outputs. The combination of a linear detector with this amplifier stage gives a response equal to that of a square-law detector in a switched receiver system.

The outputs of the polarization channel and the total power channel are recorded on charts and on punched tape.

During the second observing period direct calibration

of the polarization antenna temperature was possible by means of the signal from an argon noise tube, injected into both antenna lines through 20 db directional couplers. In this way a continuous watch can be kept on the receiver gain and gain changes corrected for. Since the accuracy of these corrections is limited mainly by the stability of the noise source, which seems to be better than 1 per cent, the remaining uncertainties due to receiver gain changes will be much less than the effects of variation of the spurious radiation (section 3).

Spurious correlated signals will yield an output in the polarization channel. This will not, however, be interpreted as a polarized signal, unless it varies with probe position angle in a roughly sinusoidal way (2 sinusoids per 360° probe rotation). If the coupling between the probes varies sinusoidally with position angle, unpolarized background radiation could give rise to apparent polarization. As this coupling is lower than 55 db, the maximum spurious polarization this mechanism could yield is about 0.4 per cent, completely negligible almost everywhere. Since any coupling inside the receiver will not vary with probe position angle, and since the circulators prevent the mixer noise from reaching the probes, the origin of any spurious polarized signals with more than 0.4 per cent polarization must be sought outside the probe-receiver system. This implies that we can only register spurious polarized radiation if the telescope (in its widest sense, i.e. including dish, feed, support structure, and the surrounding ground) partly polarizes incoming unpolarized radiation. By varying the telescope-sky configuration, we may hope to detect any systematic errors present and eliminate them from our observations. This is treated in more detail in another paper (TINBERGEN).

The formulae representing the action of the receiving system may be found in a highly simplified form in WESTERHOUT *et al.*, 1962.

3. Reduction

The main contribution to the errors in our polarization measurements arises from imperfect knowledge of the spurious polarized radiation (BROUW *et al.*, 1962). Since it turned out that this spurious radiation had decreased by about the same factor as the polarized radiation itself, the reduction methods developed for 408 Mc/s (fully described in BROUW *et al.*, 1962; BERKHUIJSEN and BROUW, 1963) could be used without

change. From the latter of these papers we take the following summary of the main reduction steps:

1. Derive the measured intensity and polarization angle by means of a least-squares solution.
2. Determine the Stokes parameters Q_m and U_m with respect to the alt-azimuth system.
3. Determine $Q_{c,1} = Q_m + \Delta Q_{E1} + \Delta Q_{Az}$, where ΔQ_{E1} and ΔQ_{Az} are the corrections depending on elevation and azimuth respectively. Determine $U_{c,1}$ in the same way.
4. Plot $Q_{c,1}$ and $U_{c,1}$ of the calibration points on the Q, U plane, and inspect the circles determined by them for large deviations.
5. Make least-squares solutions for the circles defined in 4.
6. Determine $Q_c = Q_{c,1} + \Delta Q_n$, where ΔQ_n is the time-dependent correction. Determine also U_c .
7. Calculate I_c and θ_c :

$$I_c = \sqrt{Q_c^2 + U_c^2}, \quad \theta_c = \frac{1}{2} \arctan(U/Q).$$

8. Add the parallactic and galactic parallactic angle to θ_c to derive the galactic polarization angle $\theta_{c,gal}$.
9. Determine θ_{gal} by subtracting the ionospheric Faraday rotation from $\theta_{c,gal}$.
10. Calculate Q_{gal} and U_{gal} .
11. Determine the mean value of Q_{gal} and U_{gal} for all the measurements made at one point.
12. Determine $\overline{T_b^p}$ (the full-beam polarization brightness temperature) and θ_{gal} .

Figure 2 shows a flow diagram of the computer programmes and indicates the stages at which intermediate

TABLE 1

Estimated degree of polarization at a few representative points.
 $\overline{T_b}$ = full-beam brightness temperature,
 $\overline{T_b^p}$ = full-beam polarization brightness temperature,
 $P = \overline{T_b^p} / (2\overline{T_b} + \overline{T_b^p})$ (see WESTERHOUT *et al.*, 1962, p. 200).

b^{II}	l^{II}	408 Mc/s			610 Mc/s		
		$\overline{T_b}$ (°K)	$\overline{T_b^p}$ (°K)	P (%)	$\overline{T_b}$ (°K)	$\overline{T_b^p}$ (°K)	P (%)
- 47.8	159.3	25	3.9	7.2	8	0.7	4.2
- 2.0	128.0	55	0.5	0.5	18	1.4	3.8
0.0	60.0	50	0.7	0.7	17	0.2	0.6
+ 8.0	141.0	42	5.6	6.2	14	1.6	5.3
+ 63.4	8.0	30	5.0	7.7	10	1.3	6.2
+ 64.0	176.0	25	0.3	0.6	8	0.1	0.6

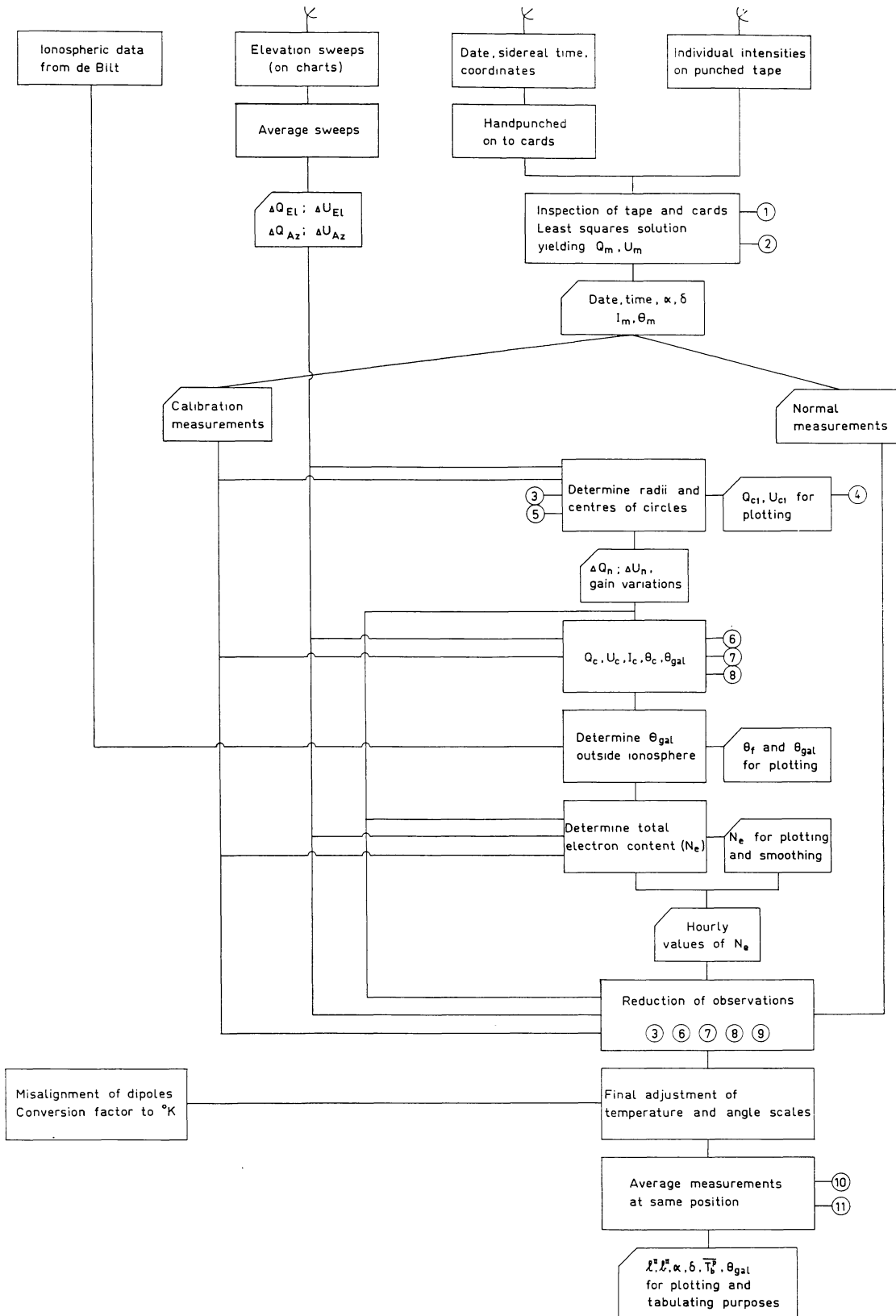

Figure 2. Flow diagram of the reduction process. Rectangles with one corner missing indicate punched card stages, while the small circles refer to the corresponding reduction steps in the text.

results are inspected. Figures 3, 4 and 5 are typical examples of these results.

Table 2 summarizes the final results, while maps of the polarized radiation at 408 Mc/s and 610 Mc/s are shown side by side in figures 6 and 7 (for a discussion see section 4). The estimated degree of polarization at a few representative points is shown in table 1.

The internal mean error for a single measurement

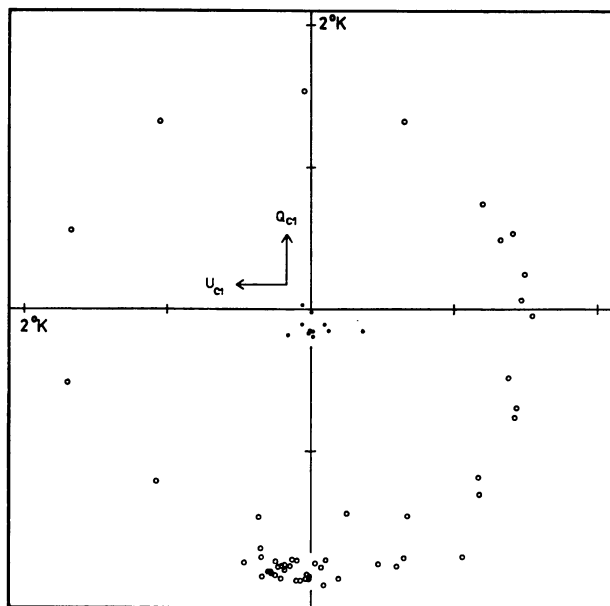

Figure 3. Observations of the point $l^{\text{II}} = 141^{\circ}.0$, $b^{\text{II}} = +8^{\circ}.0$ (circles) and of the equatorial north pole (dots) during one night. Q and U are in the alt-azimuth system, and have been corrected for elevation and azimuth dependent spurious radiation.

was 0.11°K in the full-beam polarization brightness temperature $\overline{T}_p^{\text{I}}$ and $3^{\circ}.1/\overline{T}_p^{\text{I}}$ in the polarization angle. Since we suspected the presence of systematic errors, some of our points were observed both in June and in November. Within 20° of our two main calibration points ($l^{\text{II}} = 141^{\circ}.0$, $b^{\text{II}} = +8^{\circ}.0$ and $l^{\text{II}} = 8^{\circ}.0$, $b^{\text{II}} = +63^{\circ}.4$), the mean absolute difference in Q or U is less than 0.2°K . Around $l^{\text{II}} = 110^{\circ}$, $b^{\text{II}} = -25^{\circ}$ we have found absolute differences of up to 0.7°K , which we cannot explain at present. We feel that our results in the areas of strong polarization surrounding the calibration points are substantially correct. At distances greater than 30° , the results should be treated with due caution.

The errors discussed so far should be seen as vector quantities, added to the true 'polarization vectors'

(TINBERGEN). Systematic errors in polarization angle are probably less than 2° , and the absolute calibration of the temperature scale is probably correct to ± 20 per cent. It should be noted that systematic errors in the angle or in the temperature scale do not affect the general pattern of polarization at one frequency, but only the interpretation of observations at several fre-

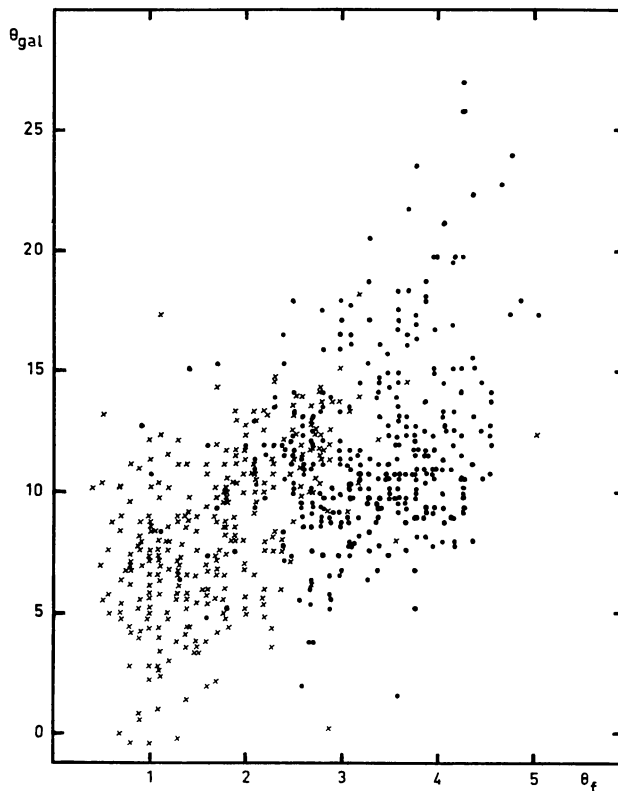

Figure 4. Correlation diagram for θ_{gal} versus the Faraday rotation expected for a parabolic F -layer. Crosses indicate measurements at $l^{\text{II}} = 141^{\circ}.0$, $b^{\text{II}} = +8^{\circ}.0$ made at night, dots are measurements made at the same point in the daytime.

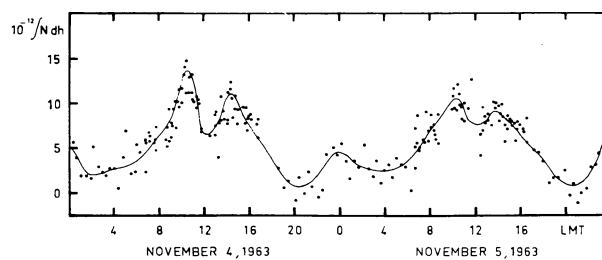

Figure 5. The total ionospheric electron content, derived from observations at $l^{\text{II}} = 141^{\circ}.0$, $b^{\text{II}} = +8^{\circ}.0$, as a function of Local Mean Time at the subionospheric point. The full line is the smoothed variation used for reduction of the other observations.

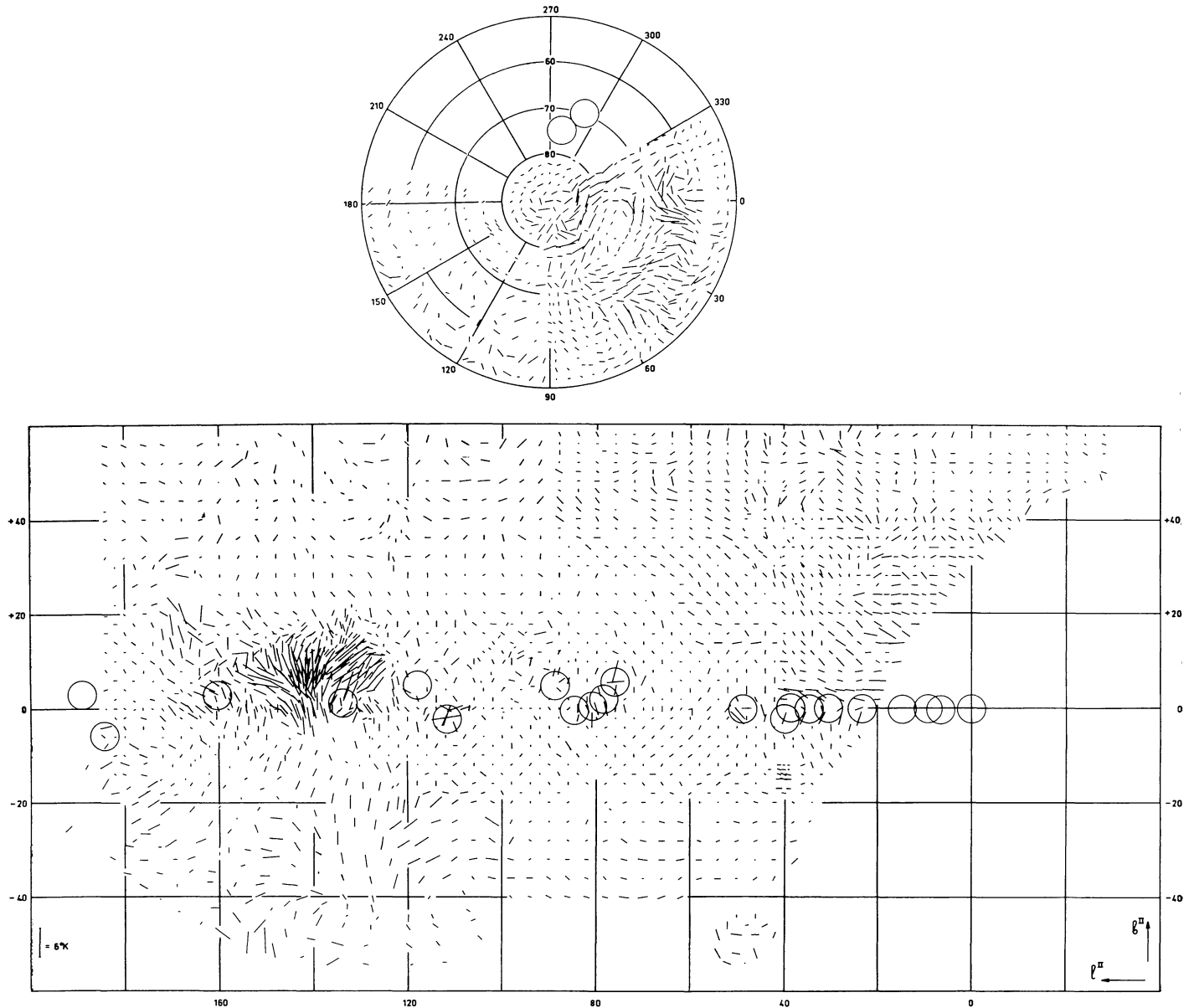

Figure 6. Polarization map at 408 Mc/s. The length and direction of the lines indicate $\overline{T_b^p}$ and θ_{gal} . Only those results were plotted which were obtained from two or more independent measurements. The circles show the positions of the strongest point sources. Only measurements within the circles could be affected by the sources.

quencies. Since the feed used at 610 Mc/s is a scaled-down version of the 408 Mc/s feed, it will have a similar spillover fraction. The uncertainty in the spillover fraction is an important source of error in the absolute calibration of the temperature scale. Therefore the ratio of the brightness temperatures at the two frequencies

(and the apparent spectral index of table 2) is probably less affected by errors than the brightness temperatures themselves.

Observations in the neighbourhood of strong point sources (i.e. only those closer than about 3° for even the strongest sources) may be influenced by unpolarized

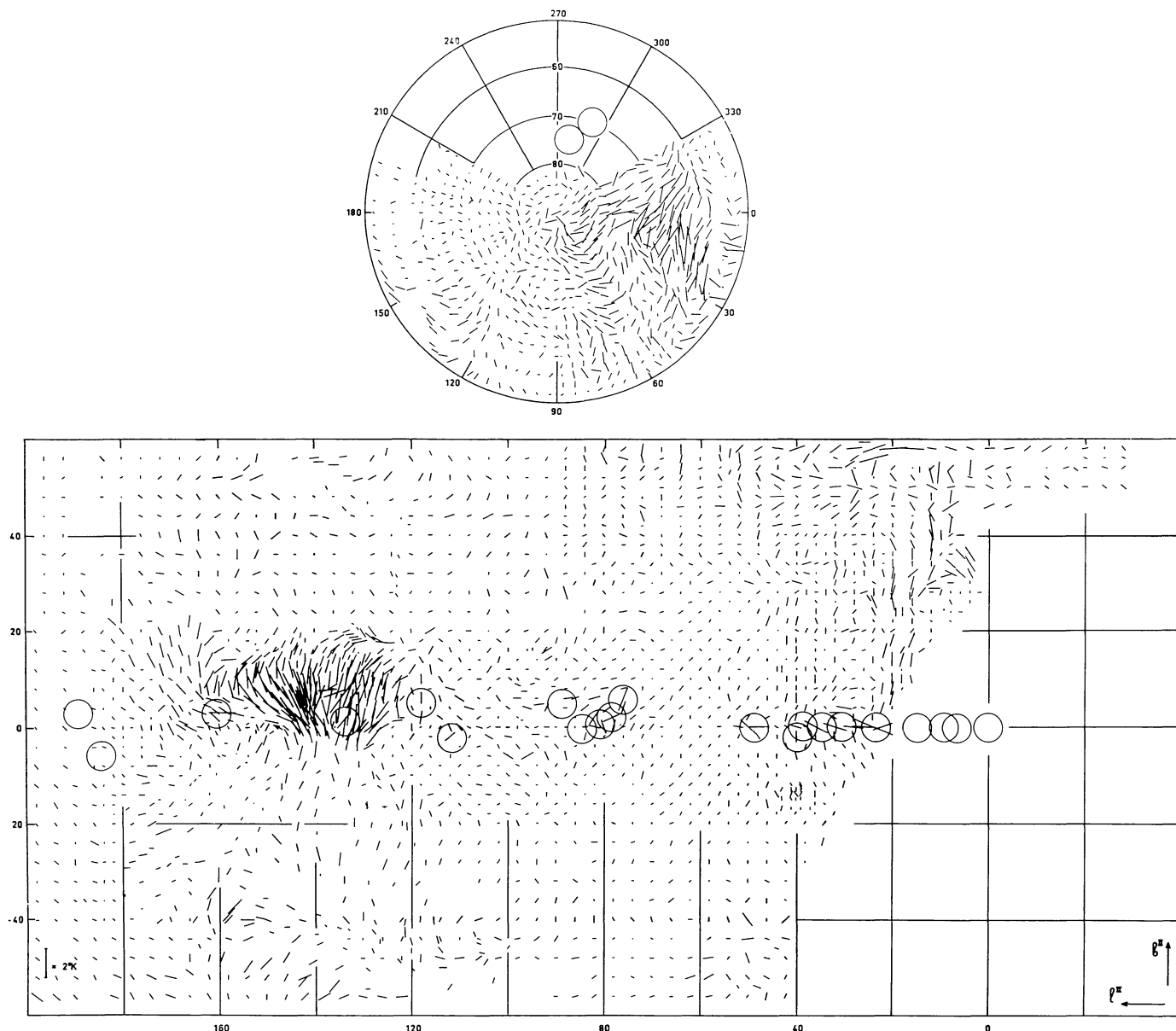

Figure 7. Polarization map at 610 Mc/s. The length and direction of the lines indicate $\overline{T_b^p}$ and θ_{gal} . Only those results were plotted which were obtained from two or more independent measurements. The circles show the positions of the strongest point sources. Only measurements within the circles could be affected by the sources.

radiation in the (polarized) sidelobes. The positions of all sources suspected of such influence are shown on the maps. The sources were taken from a survey at 408 Mc/s (DAVIS, GELATO-VOLDERS and WESTERHOUT) and their maximum effect at 610 Mc/s was computed by assuming them to be thermal. Where possible,

the 600 Mc/s survey by PIDDINGTON and TRENT (1956) was also consulted.

An attempt was made to detect circular polarization. Although antenna characteristics have not been investigated in detail, it seems that any circularly polarized component must be less than 0.4°K .

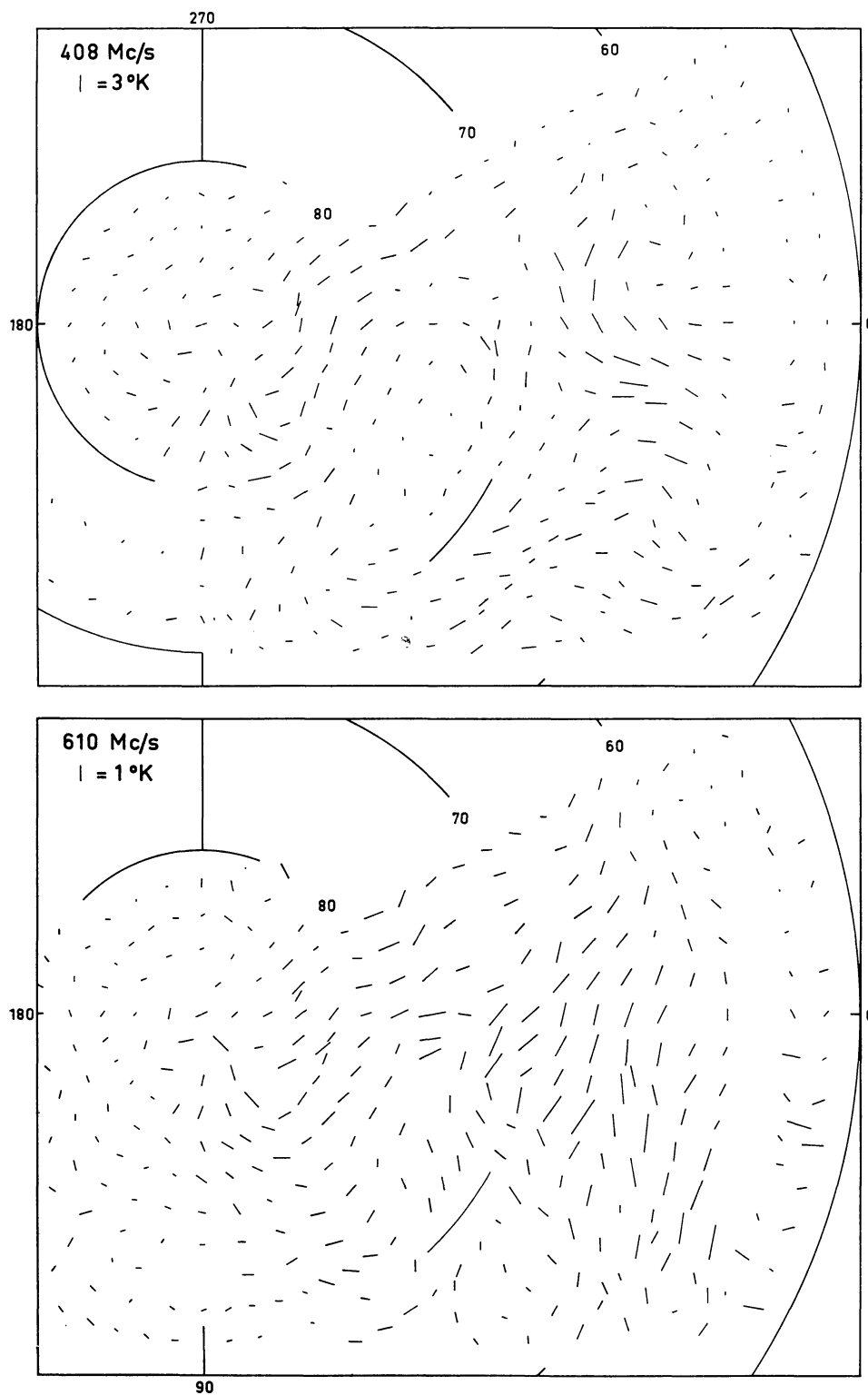

Figure 8. Detailed polarization structure around the calibration point $l^{\text{II}} = 8^\circ.0$, $b^{\text{II}} = +63^\circ.4$.

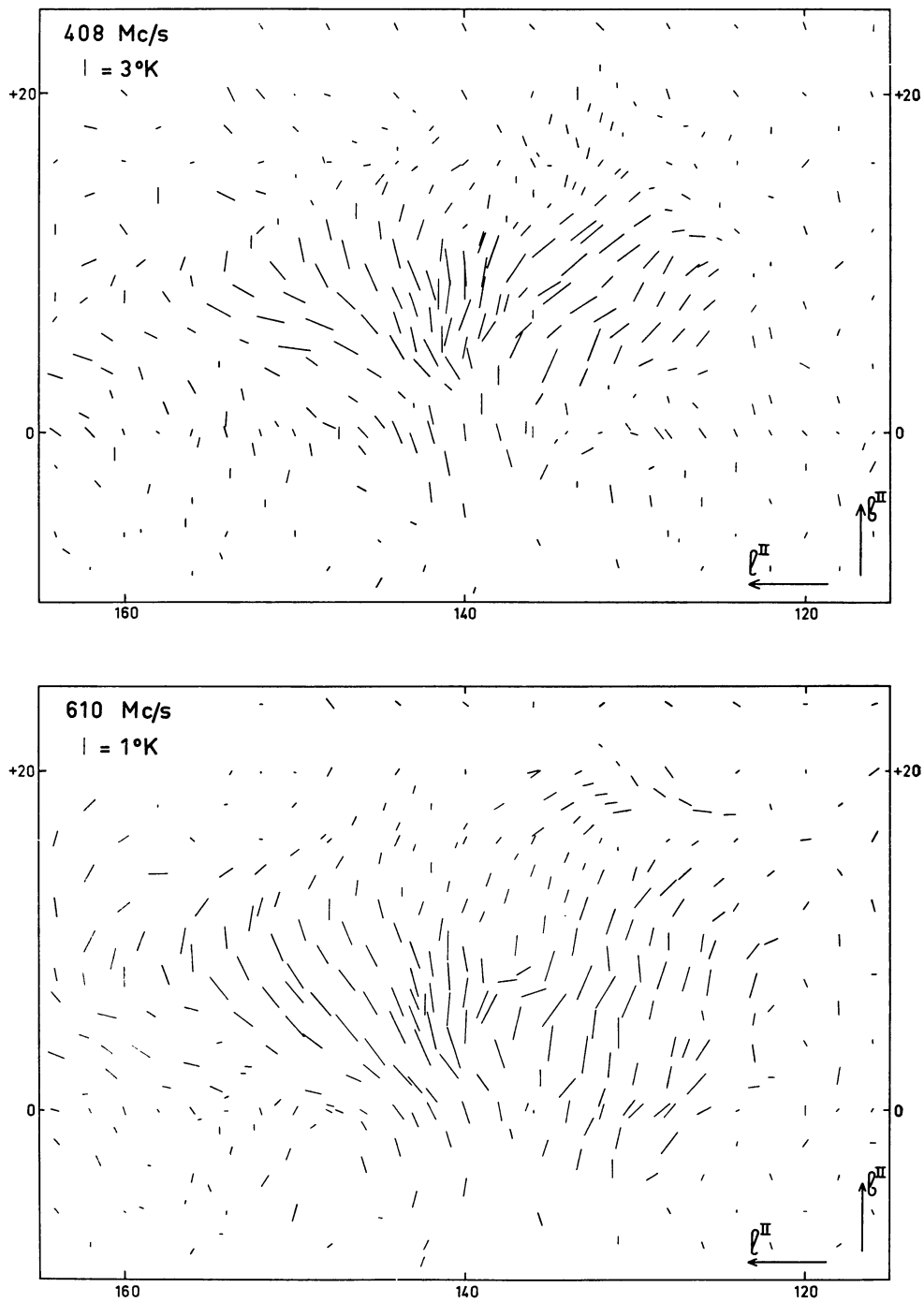

Figure 9. Detailed polarization structure around the calibration point $l^{\text{II}} = 141^\circ.0$, $b^{\text{II}} = +8^\circ.0$.

comparison with our data are available in this area. In the region bounded by $l^{\text{II}} = 130^\circ$ and 140° , $b^{\text{II}} = +16^\circ$ and $+21^\circ$, the apparent Faraday rotations are also large. Again, nothing appears on the Palomar Sky Survey, and insufficient 21-cm data are available.

Apart from these local irregularities, the fan structure appears at both frequencies, though at 408 Mc/s it is more open. One explanation of this could be that at emission the polarization angles were all equal, and that the fan shape is the result of Faraday rotation, positive on one side, negative on the other. On the assumption that we have only one polarized component in the antenna beam, we may calculate the polarization angle at emission (the 'intrinsic polarization angle'). The results of this calculation are shown in figure 11. The polarization lines of the emitted radiation are indeed much more parallel than we observe them at either of our frequencies. Since they are perpendicular to the galactic plane, our observations are consistent with a general magnetic field, in the source region, parallel to

the plane. The observed fan shape requires a magnetic field, in the rotating region, with a component towards us at $l^{\text{II}} = 150^\circ$, away from us at $l^{\text{II}} = 130^\circ$, and at right angles to the line of sight at $l^{\text{II}} = 140^\circ$. Noting that the directions at right angles to the line of sight are tangents to the celestial sphere, we see that a straight-line magnetic field H , pointing in the direction $l^{\text{II}} = 50^\circ$, is the simplest configuration that fits the above requirements (see figure 12). It should be pointed out, however, that the field H' in figure 12, of opposite sense to H , but strongly curved, would yield exactly the same pattern of observations.

It is interesting to note that the available observations of the polarization of starlight in this neighbourhood also indicate a magnetic field parallel to the galactic plane (figure 11), perpendicular to the direction $l^{\text{II}} = 135^\circ$ (HILTNER, 1956). Since all the stars observed are closer than 1 kpc, the polarized radiation observed by us could be associated with the nearest spiral arm. Over the relevant interval in galactic longitude, a

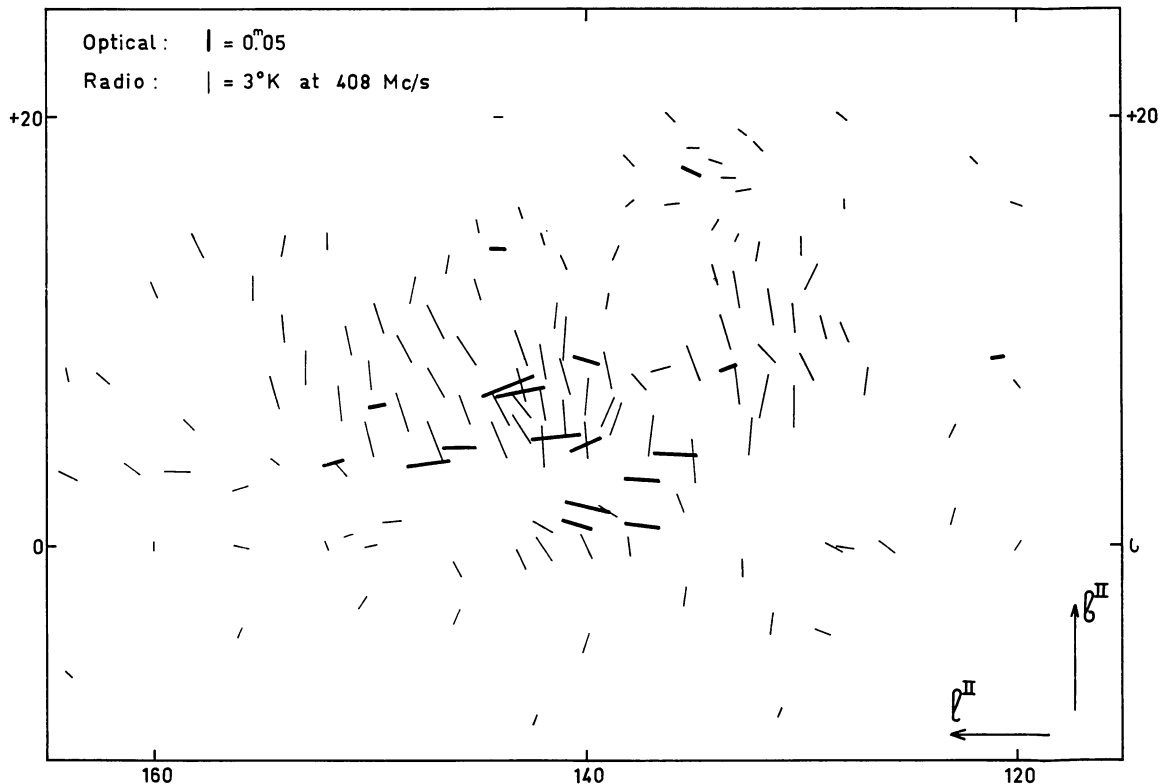

Figure 11. Comparison of 'intrinsic radio polarization' at 408 Mc/s (thin lines) with polarization of starlight (thick lines). Optical data taken from HALL (1958) and BEHR (1959). For discussion see text.

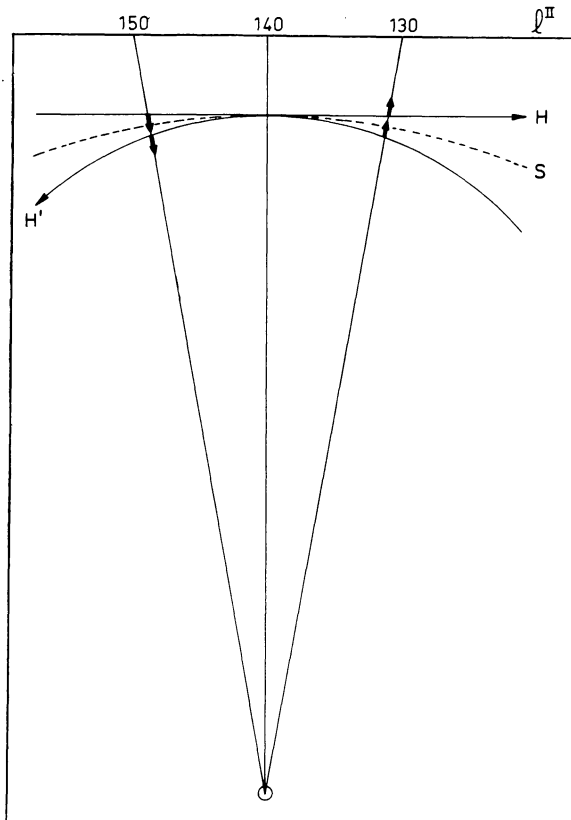

Figure 12. The relation between the celestial sphere S and two mutually indistinguishable magnetic fields H and H' (projection on to the galactic plane).

straight line is a good approximation to the shape of this arm (see for instance the maps of the neutral hydrogen distribution in WESTERHOUT, 1957). Although the field in the emitting region need not be a straight-line field perpendicular to $l^{\text{II}} = 140^\circ$, and the field in the rotating region need not be parallel to the galactic plane, the most attractive model is indeed a straight-line field, more or less parallel to the nearest spiral arm, extending through both the emitting and rotating regions.

It is worth while to compare our results with the rotation measures for point sources discussed in MORRIS and BERGE, 1964. These authors suggest that above the galactic plane the magnetic field is directed towards $l^{\text{II}} = 250^\circ \pm 20^\circ$. This direction is almost diametrically opposed to that deduced from our measurements. Moreover, the rotations found by Morris and Berge are about an order of magnitude larger than ours. These facts support our suggestion that our observa-

tions are associated with a local configuration only.

If, in line with these considerations, we take the distance through the rotating region to be less than 1 kpc, and if it is accepted that the magnetic field cannot be more than 10^{-5} gauss, we obtain for the minimum average electron density necessary to cause the observed Faraday rotations a value of about 3×10^{-4} electrons per cm^3 (cf. WESTERHOUT *et al.*, 1962, p. 208).

Although at first sight the area around $l^{\text{II}} = 15^\circ$, $b^{\text{II}} = +65^\circ$ has a different structure from the area around $l^{\text{II}} = 140^\circ$, $b^{\text{II}} = +10^\circ$, this need not reflect a difference in the sources of the polarized radiation. Inspection of figures 8 and 9 suggests that Faraday rotations are larger in the first of these regions. This is supported by the values of the apparent spectral index in the two regions. Large Faraday rotations will produce strong depolarization, resulting in small values of the apparent spectral index. For $l^{\text{II}} = 340^\circ$ through 0° to 60° , $b^{\text{II}} = +60^\circ$ to $+70^\circ$, the mean value is 1.9, whereas for $l^{\text{II}} = 130^\circ$ to 150° , $b^{\text{II}} = +6^\circ$ to $+12^\circ$, it is 2.7. However, a difference in rotation is not the only difference between the two regions. The region at $b^{\text{II}} = +65^\circ$ shows remarkable variations of apparent spectral index even over short distances: $+4.8$ and -1.8 within 5° of each other. Values greater than about $+3.5$ cannot be due to depolarization, but imply the presence of at least two polarized components, with different rotations, within the antenna beam. Similar large variations of the apparent spectral index (-1 to $+5$ within 10°) are found in the area around $l^{\text{II}} = 145^\circ$, $b^{\text{II}} = -40^\circ$. Errors are likely to be larger here, since the distance from our calibration points is greater, but our findings here corroborate earlier results obtained at Parkes, Australia (GARDNER and ROBERTS). Observations at close spacings and at several frequencies are much needed in this region.

The present investigation was a rather rough and ready survey designed to locate the most interesting parts of the sky. For the study of small areas, the accuracy could still be improved, even with the existing equipment. Surveys are also planned at 465 Mc/s and 820 Mc/s. The data to be obtained, when used in conjunction with observations of the polarization of starlight, and of the Zeeman splitting of the 21-cm line, will certainly yield considerable information about the magnetic field in at least some regions of the Galaxy.

TABLE 2

Summary of polarization observations at 408 Mc/s and 610 Mc/s.

The quantities listed are:

LAT : galactic latitude (b^{II})LONG : galactic longitude (l^{II})INT : full-beam polarization brightness temperature in $^{\circ}\text{K}$

THETA: galactic polarization angle in degrees

N : number of observations

$$\text{SP.I.: apparent spectral index} = \frac{\log(\text{INT}_{408}) - \log(\text{INT}_{610})}{\log 610 - \log 408}$$

$$\text{DIF : THETA}_{408} - \text{THETA}_{610} \quad (-90^{\circ} < \text{DIF} \leq +90^{\circ})$$
SP.I. and DIF are not listed when either $\text{INT}_{408} < 1.0$, or $\text{INT}_{610} < 0.3$, or observations at only one frequency are available.

LAT	LONG	INT 408	THETA 408	N 408	INT 610	THETA 610	N 610	SP.I.	DIF
-56.0	198.0				1.0	56	2		
-54.5	119.0								
-54.4	129.3	1.3	74	2	.3	82	2	3.3	-8
-54.0	48.0	1.1	108	1	.5	69	2	1.8	39
	52.0	1.5	67	2	.2	40	2		
	112.3	.6	98	2	.4	153	2		
-53.8	136.0	2.9	120	2	1.0	142	2	2.7	-22
-52.8	142.4	.7	123	2	.9	141	2		
-52.7	102.7	.3	0	2	.4	166	2		
-52.6	208.0				.2	11	2		
-52.4	129.0				.2	34	1		
-52.0	42.0				.3	163	2		
	46.0	2.1	16	2	.5	61	2	3.5	-45
	50.0	1.6	80	2	.4	41	2	3.2	39
	54.0	2.5	31	2	.3	28	2	5.0	3
	58.0				.7	124	2		
	62.0				.7	109	2		
	66.0				.3	90	2		
	70.0				.1	55	2		
	74.0				.2	50	2		
	78.0				.1	88	2		
	82.0				.3	123	2		
	142.0				1.0	115	2		
	146.0				.6	153	2		
	150.0				.5	136	2		
	154.0				.3	133	2		
	158.0				.3	179	2		
-64.0	198.0	.2	117	2					
-60.0	42.0	.3	154	2	.3	26	2		
	46.0	.4	151	2	.8	72	2		
	50.0	.6	135	2	.7	65	2		
	54.0	.5	128	2	.4	44	2		
	58.0	.4	132	2	.3	25	4		
	62.0	.5	112	2	.3	56	2		
	66.0	.4	115	2	.3	10	2		
	70.0	.2	111	2	.3	45	2		
	110.0	.5	128	2	.5	67	2		
	114.0	.5	125	2	.8	165	1	3.6	32
	118.0	.4	92	2	.6	54	2		
	122.0	.3	123	2	.1	45	3		
	126.0	.5	102	2	.9	118	2	.4	54
	130.0	.3	85	2	.5	91	2	1.8	-54
	134.0	.9	66	2	.6	121	4	3.6	-48
	138.0	.8	123	2					
	142.0	.5	137	2	.9	147	3	4.1	28
	146.0	.3	129	2	.9	163	1		
	150.0	.2	3	2	.9	140	2	4.4	43
	154.0	.3	43	2	.4	156	1		
	158.0	.5	29	2	.7	128	3	1.9	-46
	162.0	.4	43	2					
	166.0	.4	55	2	1.0	142	15		
	170.0	.4	51	2	.4	157	2		
	174.0	.5	60	2	.2	16	2		
	178.0	.3	76	2					
	186.0	.1	119	2	.4	31	3	2.4	-14
	190.0	.4	175	2					
	194.0	.2	100	2					
	198.0	.3	97	2					
-59.7	181.0	.1	93	2	.2	30	2		
-56.0	42.0	.3	154	2	.4	141	1		
	46.0	.5	166	2	.4	74	2	3.4	22
	50.0	.2	139	2	.8	21	2	3.0	64
	54.0	.4	144	2	.2	141	2		
	58.0	.4	110	2	.8	99	2		
	62.0	.4	108	2	.4	100	3		
	66.0	.3	92	2	.3	79	2		
	70.0	.3	107	2	.2	76	4		
	74.0	.2	108	2	.1	119	2		
	78.0	.1	101	2	.1	68	2		
	82.0	.3	137	2	.2	111	2		
	86.0	.4	99	2	.5	103	2		
	90.0	.2	94	2	.2	99	2		
	122.0	.8	96	2	.3	78	2		
	126.0	.6	81	2	.3	100	2		
	130.0	.5	77	2	.4	106	2		
	134.0	.8	114	2	.5	127	2		
	138.0	.9	123	2	.6	100	2		
	142.0	.7	134	2					
	146.0	.4	169	2	.5	71	2		
	150.0	.4	175	2	.5	0	2		
	154.0	.2	19	2	.3	8	2		
	158.0	.3	21	2	.3	87	2		
	162.0	.4	23	2	.2	95	2		
	166.0	.2	43	2	.5	164	2		
	170.0	.6	73	2	.5	4	2		
	174.0	.5	43	2	.4	56	2		
	178.0	.6	35	2	.2	71	2		
	182.0	.5	68	2	.2	55	2		
	190.0	.4	44	2	.2	50	2		
	194.0	.6	54	2	.3	56	2		
					.2	34	2		

TABLE 2 (continued)

LAT	LONG	INT 408	THETA 408	N 408	INT 610	THETA 610	N 610	SP.1.	DIF	LAT	LONG	INT 408	THETA 408	N 408	INT 610	THETA 610	N 610	SP.1.	DIF
-48.0	194.0				.2	41	1			-40.0	70.0	2.0	95	1	.4	22	2	3.9	73
	198.0				.3	37	2				74.0	1.8	84	1	.4	29	2	4.0	55
-47.8	146.0				.8	153	4	2.0	34		78.0	1.3	81	1	.2	25	2		
	159.3	1.9	7	2	.7	166	3	4.3	65		82.0	1.1	81	1	.5	2	2	2.0	79
-47.6	109.5	1.2	1	1							86.0	1.2	71	1	.3	6	2	3.4	65
-47.0	105.4	1.2	172	1	.4	79	2	2.5	-87		90.0	1.3	62	1	.4	175	2	3.2	67
-46.5	48.3	3.7	93	1							94.0	.6	76	1	.2	147	2		
	120.0	1.5	34	2	.4	2	3	3.2	32		98.0	.7	41	1	.1	156	3		
	128.0	1.0	3	2	.3	25	3	3.4	-22		102.0				.4	125	2		
-46.3	102.7	1.7	142	1							106.0				.4	111	2		
-46.2	114.0	1.3	55	1	.4	50	2	3.2	5		110.0				.6	144	2		
	151.5	3.5	142	2							114.0				.3	156	2		
-46.0	44.0	1.1	117	2	.2	53	2				118.0				.3	147	2		
	48.0	1.0	104	3							122.0				.4	2	2		
	52.0	1.5	5	2							125.5	1.5	38	2	.6	37	2	2.2	1
	133.7	.9	152	2	.2	56	2				150.0				.5	70	2		
-45.7	100.0	1.7	144	1	.2	156	2				154.0				.9	93	2		
-45.6	164.0	.5	159	2	.3	21	2				158.0				.8	137	2		
-45.3	99.0	1.2	140	1							162.0				.6	14	2		
-45.0	97.5	1.8	151	1							165.2	2.6	8	1	.5	154	2	4.0	34
	106.0	.9	103	2	.3	62	2				166.0				.2	11	2		
	139.0	2.6	155	2	.4	113	5	4.8	42		170.0				.3	22	2		
-44.5	120.0	1.4	4	2	.5	9	2	2.5	-5		178.0				.1	71	2		
	126.6	.6	142	2	.3	2	3				182.0				.1	58	2		
-44.4	156.4	2.7	34	2	.7	146	1	3.3	68		184.0				.1	26	2		
-44.2	95.0	1.2	155	1							186.0				.2	73	2		
-44.0	114.6	1.0	21	2	.5	15	2	1.8	6		190.0				.1	39	2		
	42.0				.5	79	2				194.0				.1	42	2		
	46.0	.9	7	2	.2	62	2				198.0				.1	102	2		
	50.0	.5	6	2	.8	96	2				202.0				.4	38	1		
	54.0				.2	89	2				206.0				.2	56	1		
	58.0				.3	133	2												
	62.0				.3	111	1			-39.6	151.4	2.1	119	2	.6	80	2	3.0	39
	66.0				.0		2			-39.3	129.8	2.0	47	1	.6	3	2	3.1	44
	70.0				.1	39	4			-39.2	108.2	.8	24	2	.6	169	1		
	74.0				.0		2			-39.0	139.4	2.5	71	2	.2	77	2		
	78.0				.1	140	2				147.0	2.8	111	1	.2	48	1		
	82.0				.2	96	2				158.0	1.5	28	2	1.2	141	2	0.6	67
	86.0				.2	113	2			-37.8	176.0	1.7	63	2	.0		2		
	90.0				.5	138	2			-37.6	169.0	.5	9	3	.3	25	2		
	94.0				.4	125	2			-37.4	145.0	3.0	82	2	.6	57	2	4.1	25
	98.0				.3	106	2			-37.3	151.4	1.5	98	11	.5	67	2	2.8	31
	102.0				.5	71	2				156.7	.9	152	2	1.4	138	2		
	106.0				.2	50	2			-37.2	65.8	3.3	139	1					
	110.0				.2	10	2			-37.0	152.4				.3	109	1		
	114.0				.3	25	2			-36.8	162.0	1.2	97	2	.9	167	2	0.8	-70
	118.0				.2	17	2			-36.6	122.7	3.1	169	2	.3	163	1	6.3	6
	122.0				.3	163	2			-36.4	117.0	1.8	146	2	.4	159	2	4.1	-13
	126.0				.2	177	2				128.2	1.5	6	2	.4	8	3	3.4	-2
	130.0				.2	173	2			-36.3	79.0	2.7	152	1					
	133.0	.3	125	2	.1	118	2			-36.0	42.0	.8	157	2	.2	44	2		
	144.0	1.8	175	2	.7	134	2	2.5	41		46.0	1.0	132	2	.3	5	2	3.3	-53
	154.0				.7	111	2				50.0	.2	97	2	.4	137	2		
	158.0				.4	72	2				54.0	1.3	89	2	.3	34	2	3.3	55
	162.0				.2	68	2				58.0	1.0	106	2	.0		2		
	166.0				.2	96	2				62.0	1.1	132	2	.0		2		
	170.0				.4	52	2				66.0	.6	114	2	.4	130	2		
	174.0				.2	75	2				70.0	.5	101	2	.2	124	2		
	178.0				.2	52	2				74.0	1.0	74	1	.1	151	2		
	182.0				.2	62	2				78.0	1.2	48	1	.2	4	2		
	186.0				.2	41	2				82.0	.7	58	1	.1	169	2		
	190.0				.3	50	2				86.0	1.0	37	1	.4	154	2	2.6	63
	194.0				.4	59	1				90.0	.8	52	1	.4	165	2		
	198.0				.3	43	2				94.0	1.3	84	1	.4	144	3	3.0	-60
-43.3	92.6	1.2	156	1							98.0	1.5	90	1	.3	141	3	3.6	-51
-43.2	168.5	.3	81	2	.2	117	1				102.0	1.6	75	2	.6	173	1	2.3	82
-43.0	107.0	1.1	54	2	.3	14	2	3.3	40		106.0	.7	38	3	.8	177	1		
	139.6	1.5	136	2	.2	89	2				182.0				.1	45	2		
-42.8	91.4	1.2	158	1							184.0				.0		2		
-42.6	121.3	2.9	176	1	.7	2	2	3.7	-6		186.0				.2	54	2		
	149.0	.7	139	2	.3	71	2				188.0				.2	18	2		
-42.5	127.7	1.8	6	2	.4	36	2	4.0	-28		190.0				.2	47	2		
-42.3	161.0	1.5	93	2	.2	29	2				194.0				.3	60	2		
-42.0	132.8	1.2	176	2	.1	39	2				198.0				.2	45	2		
-41.7	135.2	1.4	131	1	.2	53	2				202.0				.3	60	1		
-41.5	145.7	1.6	140	2	.4	88	2	3.7	52		206.0				.2	53	1		
-41.3	137.7	1.1	115	2	.1	50	2			-35.8	133.8	1.4	17	2	.4	162	2	3.3	35
-41.0	153.7	1.9	120	2	.7	103	2	2.6	17	-35.7	111.6	1.6	122	2	.8	179	1	1.9	-57
-40.6	121.4	2.8	177	1	.4	166	3	4.8	11	-35.5	150.3	2.0	92	2	.3	83	2	4.6	9
-40.5	127.5	1.4	8	2	.3	10	2	3.7	-2	-35.0	77.0	1.7	150	1					
	172.5	.3	167	3	.4	126	2				172.6	1.1	77	2	.2	112	2		
-40.2	115.3	.9	143	2	.5	177	2				179.5	1.6	78	1	.1	5	2		
	142.5	2.3	111	2	.4	80	2	4.3	31	-34.8	139.0	.4	171	2	.5	1	1		
-40.0	42.0				.7	132	2			-34.6	161.6	1.6	80	2	.9	149	3	1.4	-69
	46.0	1.2	131	1	.2	171	2			-34.5	166.0	.9	142	2	.2	34	2		
	50.0	1.6	111	1	1.1	32	2	1.0	79	-34.4	76.2	2.2	148	1					
	54.0	.2	125	1	.4	20	2			-33.4	24.8	1.7	95	1					
	58.0	.3	117	1	.3	6	2			-33.3	144.3	.9	41	2	.6	21	1		
	62.0	1.2	114	1	.2	93	2				155.2	.7	121	2	.5	62	2		
	66.0	1.7	116	1	.2	28	2			-33.0	109.7				.6	4	1		

TABLE 2 (continued)

LAT	LONG	INT 408	THETA 408	N 408	INT 610	THETA 610	N 610	SP.1.	DIF	LAT	LONG	INT 408	THETA 408	N 408	INT 610	THETA 610	N 610	SP.1.	DIF	
-32.7	58.7				.1	113	1			-26.8	67.5	1.1	159	1						
-32.6	61.0	3.2	143	1						-26.6	175.7	2.0	90	2	.5	102	2	3.4	-12	
	123.7	1.7	162	2	.2	161	2			-26.3	139.3	2.7	21	3	1.0	17	2	2.5	4	
-32.5	118.6	2.6	115	2	.3	150	4	5.4	-35	-26.2	55.7	2.6	152	1						
-32.3	128.8	2.6	4	2	.3	173	2	5.2	11	-26.0	66.8	1.3	172	1						
-32.2	37.5	1.6	138	2							154.0	.8	17	1	.5	20	2			
	176.0	1.5	89	2	.3	112	2	3.9	-23		158.0	1.0	140	2	.5	113	3	1.5	27	
-32.0	42.0	.8	92	2	.1	80	2			-25.6	154.8	1.2	166	1	.2	18	1			
	46.0	.3	167	2	.2	72	2				192.0	1.7	129	6						
	50.0	.7	130	2	.3	4	2			-25.5	152.3	1.9	28	2	.2	3	2			
	54.0	.6	120	2	.3	66	2			-25.2	174.0	2.8	116	2	.2	77	2			
	58.0	1.0	98	3	.0		2			-25.0	143.7	2.6	42	5	.4	17	2	4.4	25	
	62.0	1.5	101	2	.1	126	2			-24.6	21.0	1.5	117	1						
	66.0	1.1	91	2	.3	144	2				122.7	2.9	126	2	.3	157	4	5.4	-31	
	70.0	1.7	85	2	.1	133	2	3.0	-53	-24.5	65.4	2.3	165	1						
	74.0	1.2	70	2	.1	96	2				119.3	3.4	126	2	.2	166	4			
	78.0	.9	67	2	.1	143	2				127.0	2.2	166	1	.6	165	4	3.4	1	
	82.0	.8	97	2	.1	51	2			-24.3	162.0	1.5	151	2	.2	113	2			
	86.0	.8	88	2	.3	40	2			-24.0	38.0	.6	116	2	.1	172	2			
	90.0	.3	110	2	.2	90	2				42.0	.9	88	2	.1	33	2			
	94.0	.4	147	2	.4	50	3				46.0	.7	110	2	.1	35	2			
	98.0	1.1	67	2	.3	106	3	2.9	-39		50.0	1.0	77	2	.1	0	2			
	102.0	2.2	84	2	.3	148	4	4.8	-64		54.0	.3	91	2	.2	141	2			
	106.0	1.6	105	2	.3	155	4	4.1	-50		58.0	.1	2	2	.2	157	2			
	110.0	1.6	124	3	.4	160	3	3.6	-36		62.0	1.0	76	2	.4	143	2	2.4	-67	
	114.5	3.3	120	2	.6	176	3	4.1	-56		66.0	1.0	77	2	.3	158	2	3.1	-81	
	169.4	.6	101	2	.2	148	2				70.0	.5	78	2	.2	148	3			
	182.0				.2	43	2				74.0	.6	122	2	.5	100	2			
	184.0	1.2	139	1	.2	11	2				78.0	.3	98	2	.1	102	3			
	186.0				.2	59	2				82.0	1.0	150	2	.4	87	3	2.2	63	
	190.0				.1	49	2				86.0	.5	148	2	.2	16	3			
	194.0				.2	63	2				90.0	.4	170	2	.1	33	3			
	198.0				.1	27	2				94.0	.5	141	2	.2	156	3			
	202.0				.3	55	1				98.0	.8	166	2	.4	178	3			
	206.0				.3	57	1				102.0	3.2	56	2	.3	139	4			
-31.8	182.6	1.3	59	2							106.0	2.2	65	2	.3	139	4	5.1	-74	
-31.7	134.0	2.4	10	1	.5	178	2	3.8	12		110.0	1.2	114	2	.2	142	4			
	166.0	1.7	111	2	.3	43	2	4.7	68		114.0	2.1	106	2	.5	161	4	3.8	-55	
-31.5	149.0	3.4	97	2	.5	42	1	4.7	55		131.4	1.7	5	2	.4	171	2	3.5	14	
-30.8	159.8	.7	171	2	1.0	179	2				178.0	1.6	121	2	.4	108	2	3.5	13	
-30.7	138.8	1.3	55	2	.1	158	2				182.0			1	.1	99	2			
-30.0	150.0	2.5	74	1							184.0	1.3	82	1	.1	164	2			
	154.0	1.3	71	2	.5	70	2	2.2	1		186.0				.6	63	2			
	158.0	1.2	4	2	.6	156	3	1.7	28		190.0				.1	158	2			
											194.0				.2	58	2			
-29.6	70.5	1.3	170	1							198.0				.2	40	2			
-29.4	76.5				.3	37	1				206.0				.3	51	1			
	172.6	.6	93	2	.3	111	2			-23.8	34.3	.6	132	2	.5	165	2			
-29.3	143.5	2.2	32	2	.5	14	2	3.8	18		64.8	1.1	163	1						
	179.0	1.6	79	2	.4	83	2	3.4	-4	-23.2	135.6	1.7	1	1						
-28.6	120.8	2.5	124	2	.5	161	4	4.2	-37		147.8	2.3	81	2	1.0	45	2	2.2	36	
	170.3	2.9	120	2	.3	125	2	6.1	-5		156.4	.4	10	2	.1	132	4			
-28.5	125.5	2.6	174	2	.3	163	4	3.1	11	-22.8	137.2				.5	10	1			
-28.4	167.0	.6	45	1	.3	81	2			-22.3	63.5	1.6	164	1						
-28.3	117.0	3.1	123	2	.3	173	4	5.6	-50	-22.0	139.7	1.3	22	2	.2	7	2			
-28.2	69.0	1.3	170	1						-21.8	171.6	2.4	128	2	1.2	108	2	1.8	20	
-28.0	38.0	1.3	106	1	.1	165	2			-21.5	62.8	1.7	163	1						
	42.0	.9	116	2	.2	22	2			-21.4	165.8	1.1	143	2	.5	128	2	2.0	15	
	46.0	.6	107	2	.2	3	2			-21.3	76.8	.5	53	1						
	50.0	.7	110	2	.2	168	2			-21.2	151.7	.5	162	2	.3	154	2			
	54.0	.7	114	2	.3	17	2			-20.7	160.0	.6	155	2	.4	138	2			
	58.0	.9	68	2	.3	1	2			-20.6	121.2	2.7	172	2	.5	3	2	4.0	-11	
	62.0	1.0	84	1	.1	129	2				124.3	2.3	167	2	.3	169	4	5.3	-2	
	66.0	1.0	90	2	.2	157	2				143.6	.5	170	2	.6	173	2			
	70.0	1.0	79	2	.2	101	3			-20.3	128.3	2.8	174	2	.5	174	4	4.6	0	
	74.0	1.5	51	2	.3	168	3	4.3	63	-20.0	34.0	.1	155	2	.4	154	2			
	78.0	.9	106	2	.3	169	2				38.0	.4	58	2	.2	158	2			
	82.0	.4	122	2	.2	117	2				42.0	.5	83	2	.2	146	2			
	86.0	.3	36	2	.3	0	1				46.0	.8	68	2	.2	8	2			
	90.0	.5	148	2	.2	175	2				50.0	.2	82	2	.2	159	2			
	94.0	.4	27	2	.4	4	3				54.0	.1	16	2	.1	176	2			
	98.0	1.7	157	2	.2	36	3				58.0	.4	8	2	.2	4	2			
	102.0	1.4	45	2	.3	146	4	4.3	79		62.0	.4	70	2	.2	157	2			
	106.0	.9	93	2	.2	135	4				66.0	.6	119	2	.2	110	2			
	110.0	1.2	125	2	.3	144	4	3.5	-19		70.0	.6	82	2	.1	168	2			
	114.0	2.5	138	1	.4	164	4	4.3	-26		74.0	.7	118	2	.2	171	2			
	164.0	2.1	117	2	.7	101	2	3.0	16		78.0	.5	124	2	.3	66	2			
	178.0	1.0	120	2	.4	102	2	2.3	18		82.0	.1	25	2	.2	19	2			
	182.0				.1	85	2				86.0	.3	134	2	.2	13	2			
	184.0	.8	74	1	.1	84	2				90.0	.1	55	2	.3	51	3			
	186.0				.4	73	2				94.0	.2	162	2	.0		2			
	190.0				.3	9	2				98.0	.6	163	2	.4	16	2			
	194.0				.3	57	2				102.0	.7	63	2	.1	119	4			
	198.0				.2	56	2				106.0	1.2	100	3	.1	170	4			
	202.0				.3	48	1				110.0	1.6	125	2	.2	26	4			
	206.0				.4	60	1				114.0	3.1	133	2	.3	17	4	5.9	-64	
-27.7	37.8	1.3	97	1							118.0	2.6	161	2	.5	8	4	4.0	-27	
-27.6	148.0	2.6	82	1	.3	33	2	5.7	49		122.0	2.8	169	2	.3	179	4	5.5	-10	
-27.4	134.8	2.7	0	2	.9	174	2	2.8	6		174.0	2.7	124	2	.6	119	2	3.9	5	
-27.0	168.7	1.2	32	1	.2	128	2				178.0	1.2	121	2	.3	111	4	3.2	10	

1964BAN...17..465B

TABLE 2 (continued)

LAT	LONG	INT 408	THETA 408	N 408	INT 610	THETA 610	N 610	SP.1.	DIF	LAT	LONG	INT 408	THETA 408	N 408	INT 610	THETA 610	N 610	SP.1.	DIF
-20.0	182.0				.1	103	2			-16.0	202.0				.4	66	1		
	184.0	.1	0	1							206.0				.3	90	1		
	186.0				.2	23	2			-15.6	132.8	1.4	172	2	.3	21	2	3.6	-29
	190.0				.2	38	2			-15.2	58.0	1.6	162	1					
	194.0				.2	36	2			-15.0	39.0	1.0	86	2	.2	178	2		
	198.0				.2	23	2				40.0	1.1	79	2	.2	0	4		
	202.0				.4	30	1				41.0	1.0	89	2	.2	26	2		
	206.0				.4	47	1				43.0	1.4	86	1	.3	0	2	3.8	86
											167.0	.3	179	2	.0				
											172.4	.4	124	2	.1	113	2		
-19.8	132.2	3.0	178	2	.6	179	2	4.0	-1	-14.8	154.4	.4	145	2	.2	158	2		
-19.6	51.0	2.7	163	1						-14.7	136.3	1.1	156	2	.1	126	2		
-19.0	136.0	2.0	175	2	.3	176	1	5.1	-1		146.8	.9	137	2	.3	166	2		
	147.4	.7	47	2	.4	12	2			-14.4	57.5	1.5	163	1					
	155.4	.4	168	2	.2	145	2			-14.0	32.0	.1	98	2	.2	171	2		
-18.3	169.2	.7	118	2	.2	111	2				36.0	.4	54	3	.4	3	2		
-18.0	32.0	.4	88	1	.3	163	2				39.0	1.1	67	2	.3	158	2	2.9	89
	36.0	.5	82	2	.1	158	2				40.0	1.3	68	2	.4	25	2	2.9	43
	40.0	.7	95	2	.2	143	2				41.0	.6	67	2	.3	170	2		
	44.0	1.0	77	2	.2	168	2				44.0	.5	48	2	.5	23	2		
	48.0	.7	76	2	.2	163	2				48.0	.6	114	2	.3	177	2		
	52.0	.4	83	2	.1	165	2				52.0	1.2	117	2	.2	178	2		
	56.0	.5	74	2	.2	160	2				56.0	.8	103	2	.3	157	2		
	60.0	.3	129	2	.2	149	2				60.0	.4	106	2	.1	146	2		
	64.0	1.0	65	2	.2	148	2				64.0	.3	130	2	.2	140	2		
	68.0	.6	93	2	.3	122	2				68.0	1.0	89	2	.3	141	2	3.5	-52
	72.0	.5	71	1							72.0	.7	91	2	.0				
	76.0	.7	94	1							75.8	.7	137	1	.1	106	1		
	80.0	2.1	77	1							76.0	.6	137	2	.0				
	84.0	1.7	66	1							80.0	.1	74	2	.1	101	2		
	88.0	.3	96	2	.1	139	2				84.0	.4	70	2	.0				
	92.0	.5	11	2	.2	107	2				88.0	.9	29	2	.1	167	2		
	96.0	.5	99	2	.1	147	2				92.0	.3	153	2	.3	45	2		
	100.0	.9	14	2	.2	57	2				96.0	.7	164	2	.3	45	2		
	104.0	.6	113	2	.1	117	2				100.0	.4	45	2	.2	77	2		
	108.0	1.7	102	2	.2	69	2				104.0	1.3	49	2	.4	73	2	2.9	-24
	112.0	1.0	78	2	.3	169	2	3.3	89		108.0	.8	42	2	.3	66	2		
	116.0	1.5	112	2	.4	20	2	3.2	-88		112.0	.8	86	2	.2	44	2		
	163.6	1.0	156	2	.1	156	2				116.0	.8	104	2	.4	105	2		
	172.0	1.0	112	2	.3	98	2	3.4	14		116.0	1.3	71	2	.4	83	2	2.9	-12
	176.0	2.7	125	2	.5	101	2	4.1	24		120.0	.7	52	2	.2	81	2		
	182.0	1.7	103	1	.0						122.0	.6	59	1	.1	53	2		
	188.0	2.3	156	1	.5	163	2	3.7	-7		122.0	.4	179	2	.1	156	2		
-17.8	139.8	1.7	165	1						-13.8	57.0	1.7	169	1					
-17.6	59.8	.7	98	2	.2	3	2			-13.6	139.7	1.8	152	2	.7	163	2	2.1	-11
-17.0	37.0	.4	98	2	.2	168	2			-13.5	176.5				.2	61	1		
	39.0	.9	90	2	.2	172	2			-13.4	39.0	.3	98	2	.3	173	2		
	41.0	1.3	89	2	.2	167	2			-13.0	40.0	.6	85	2	.3	175	2		
	43.0	.9	66	1	.4	167	2				41.0	.7	55	2	.3	3	2		
	45.0	.7	123	2	.1	156	2				43.0	.2	122	2	.3	169	2		
-16.8	59.2	1.7	161	1							43.0	.2	122	2	.3	169	2		
	179.0	1.0	121	9	.3	122	2	3.3	-1		150.0	1.1	167	2	.3	153	2	3.3	34
-16.6	122.8	.8	148	2	.3	26	2			-12.8	77.0	.3	143	59					
-16.5	125.7	1.8	171	2	.1	113	4			-12.6	124.0	2.5	19	2	.5	23	2	4.0	-4
	159.0	.7	158	2	.2	168	2				39.0				.3	21	2		
	159.0	.7	158	2	.2	168	2	2.7	1	-12.5	39.0				.3	21	2		
-16.3	143.4	2.1	158	2	.7	157	2			-12.4	126.7	1.3	36	2	.3	43	2	3.3	-7
-16.2	129.3	1.4	177	2	.3	8	4	3.6	-11		157.6	.2	154	2	.2	145	2		
-16.0	17.3	1.6	114	1							188.0	.9	167	4					
	34.0	.3	41	2	.2	42	2				147.0	2.3	159	2	.4	4	2	4.5	-25
	36.0	.7	107	2	.2	178	2				162.0				.2	139	1		
	39.0				.5	158	1				30.0	1.2	38	2	.5	164	2	2.3	54
	46.0	.2	24	2	.6	9	2				34.0	1.2	14	2	.3	11	2	3.8	3
	50.0	.6	79	2	.4	154	2				36.0	.7	109	2	.3	15	2		
	54.0	1.0	118	2	.4	177	2	2.2	-59		39.0	.5	95	2	.3	18	2		
	58.0	.8	121	2	.3	159	2				40.0	.3	98	2					
	62.0	.8	16	2	.1	177	2				41.0	.6	90	2	.2	31	2		
	66.0	.8	37	2	.2	135	2				46.0	.6	13	2	.4	166	2		
	70.0	.6	34	2	.1	130	2				50.0	.7	10	2	.2	159	1		
	74.0	.4	31	2	.1	141	2				54.0	.6	1	2	.3	128	2		
	78.0	.4	135	2	.1	137	2				58.0	.5	2	2	.2	154	2		
	82.0	.5	36	2	.1	119	2				62.0	.4	148	2	.3	140	2		
	86.0	.5	10	2	.1	5	2				66.0	.8	140	2	.3	144	2		
	90.0	.7	30	2	.2	132	2				70.0	.3	161	2	.1	126	2		
	94.0	.4	165	2	.2	155	2				74.0	.3	150	2	.0				
	98.0	.6	167	2	.4	75	2				78.0	.5	156	2	.0				
	102.0	.2	56	2	.1	100	4				82.0	.4	173	2	.0				
	106.0	1.0	113	2	.1	110	4				86.0	.2	174	2	.3	79	2		
	110.0	.7	69	1							90.0	.3	32	2	.1	36	2		
	110.2	1.6	44	1	.1	55	4				94.0	.8	155	2	.1	66	2		

LINEAR POLARIZATION OF THE GALACTIC BACKGROUND AT 50 CM

481

TABLE 2 (continued)

LAT	LONG	INT 408	THETA 408	N 408	INT 610	THETA 610	N 610	SP.1.	DIF	LAT	LONG	INT 408	THETA 408	N 408	INT 610	THETA 610	N 610	SP.1.	DIF
-12.0	164.0	3.0	123	1	.1	5	2			- 8.0	170.0	1.9	57	2	.2	102	2		
	186.0				.4	46	2				174.0	1.2	75	2	.6	91	2	1.6	-18
	190.0				.2	68	2				178.0	2.0	60	2	.1	76	2		
	194.0				.3	55	2				184.0	1.3	146	1	.1	49	2		
	198.0				.3	58	2				186.0				.2	167	2		
	202.0				.3	34	1				192.0				.4	95	2		
	206.0				.4	56	1				198.0				.3	33	2		
-11.8	180.2	.5	75	5	.0		2				202.0			.4	60	2			
-11.6	175.4	.8	103	2	.5	103	2				206.0			.5	36	1			
-11.4	133.2	.4	52	2	.6	172	2			- 7.7	131.0	1.5	18	2	.4	0	2	3.2	18
-11.2	49.5				.3	151	1				154.3	1.1	20	2	.1	95	2		
-11.0	55.3	1.6	172	1						- 7.0	163.4	1.3	52	2					
	165.2	.2	12	2	.1	156	2				107.4	1.1	105	1					
-10.7	149.6	1.0	161	2	.3	144	2	3.1	17	- 6.5	135.6	1.1	19	2	.7	20	2	1.2	- 1
-10.6	153.2	1.0	162	2	.3	144	2	3.4	18	- 6.4	38.0	.5	3	2					
-10.5	146.0	1.2	174	2	.7	170	2	1.4	4		145.2	.5	57	3	.1	90	2		
-10.4	127.2	.2	10	1	.4	32	2			- 6.3	127.3	.4	19	2					
	136.4	1.1	13	4	.5	6	2	2.0	7	- 6.2	52.3	1.5	16	1					
-10.3	54.8	1.9	166	1						- 6.0	24.0	.6	41	2	.4	9	2		
-10.0	28.0	1.1	29	2	.4	12	2	2.6	17		28.0	.6	4	2	.4	19	2		
	32.0	1.1	23	2							32.0	1.6	8	2	.1	33	2		
	36.0	1.3	15	2							36.0	.9	28	2	.3	11	2		
	44.0	1.3	15	2	.2	6	2				40.0	1.0	15	2	.5	8	2	1.9	7
	48.0	.5	169	2	.3	2	2				44.0	1.3	179	2	.3	4	2	3.7	- 5
	52.0	.4	149	2	.1	164	2				46.0	.6	178	2	.3	9	2		
	56.0	.6	146	2	.2	152	2				52.0	.5	2	2	.2	5	2		
	60.0	.9	132	2	.2	149	2				56.0	.3	132	2	.2	164	2		
	64.0	1.0	136	2	.4	141	2	2.4	- 5		60.0	1.2	146	2	.2	145	2		
	68.0	.9	130	2							64.0	.5	124	2	.3	3	2		
	72.0	.6	172	2	.5	172	2				68.0	.7	141	2	.2	148	2		
	76.0	.7	168	2	.2	143	2				72.0	.7	144	2	.3	22	2		
	80.0	.1	142	2	.1	139	2				76.0	.4	13	2	.2	27	2		
	84.0	.8	40	2	.2	133	2				80.0	.1	58	2	.1	13	2		
	88.0	.9	55	2	.2	164	2				84.0	.7	62	1	.3	18	2		
	92.0	.2	35	2	.4	24	2				88.0	.3	29	2	.6	13	2		
	96.0	.6	142	2	.3	42	2				92.0	.7	170	2	.7	26	2		
	100.0	.2	8	2	.3	34	2				96.0	.7	21	2	.9	121	4		
	104.0	.3	86	2	.2	74	2				100.0	.6	178	2	.6	53	2		
	108.0	.7	145	2	.2	47	2				104.0	.1	88	2	.3	77	2		
	112.0	.9	97	2	.1	23	2				108.0	1.1	158	2	.1	120	2		
	116.0	.4	0	2	.1	20	2				112.0	.5	169	2	.3	1	2		
	120.0	.5	177	2	.1	102	2				116.0	.9	4	2	.2	39	2		
	124.0	.2	23	2	.4	100	2				120.0	1.0	170	2	.1	117	2		
	128.0	.6	169	2	.5	12	2				124.0	.3	12	2	.1	158	2		
	150.8	1.1	145	2							128.0	.7	9	2	.2	25	2		
	164.0	.5	167	2	.1	61	2				150.0	1.3	0	2	.9	161	2	0.8	19
	168.0	.8	155	2	.1	90	2				154.0	.9	155	2	.1	18	2		
	172.0	.6	171	2	.3	68	2				160.0	.5	166	2	.1	41	2		
	176.0	1.6	71	2	.6	70	2	2.6	1		164.0	1.1	31	2	.4	40	2	2.8	- 9
	180.0	.5	32	2	.2	34	4				168.0	.5	163	2	.0	2	2		
	182.0	.8	106	1	.2	23	2				172.0	.2	59	3	.5	79	3		
											176.0	.2	144	1	.1	28	2		
- 9.7	160.6	.2	63	2	.1	11	2				180.0	.4	166	2	.2	21	2		
- 9.3	139.4	1.0	151	2	.3	144	2	2.9	7	- 5.6	159.0	.6	175	2	.2	59	2		
- 9.2	76.2				.4	50	1			- 5.7	184.6	.3	68	2					
- 9.0	142.5				.6	164	1			- 5.5	59.0	.6	170	1					
- 8.8	145.0	1.6	159	2						- 5.4	156.4	1.3	175	2	.0		2		
- 8.7	36.7				.4	178	2			- 5.3	51.8	1.2	27	1					
- 8.3	156.0	.5	173	2	.2	144	2				143.0	1.0	64	2	1.0	162	2	0.1	82
- 8.2	55.0	1.6	136	1						- 5.0	64.3	.4	131	1	.4	131	1		
- 8.0	26.0	.6	73	2	.4	27	2			- 4.6	140.0	2.5	10	2	1.1	175	2	2.1	15
	30.0	1.1	5	2	.2	21	2				155.2				.3	18	1		
	34.0	.9	18	2	.5	13	2				53.6				.2	174	1		
	38.0	.7	173	2						- 4.2	151.7	1.2	5	2	.8	147	2	1.0	38
	42.0	1.4	177	2	.2	179	2			- 4.0	26.0	1.5	163	2	.5	30	2	2.6	-47
	46.0	.6	10	2	.5	14	2				30.0	1.6	176	2	.4	30	2	3.4	-34
	50.0	.8	161	2	.2	20	2				34.0	.7	171	2	.6	11	2		
	54.0	.4	136	2	.1	177	2				38.0	.2	44	2	.3	165	2		
	58.0	.4	133	2	.2	138	2				42.0	.3	173	2	.4	14	2		
	62.0	.7	130	2	.1	163	2				46.0	.4	176	2	.3	176	1		
	66.0	.4	128	2	.3	161	2				50.0	.7	12	2	.0	2	2		
	70.0	.9	143	2	.2	161	2				54.0	.5	165	2	.1	3	2		
	74.0	.3	31	2	.2	6	2				58.0	1.0	160	2	.2	158	2		
	78.0	.7	30	2	.1	145	2				62.0	.7	148	2	.1	159	2		
	82.0	.7	32	2	.3	149	2				66.0	1.2	147	2	.4	128	1	2.7	19
	86.0	2.0	34	2	.4	162	2	3.8	52		70.0	.7	141	2	.2	169	2		
	90.0	.9	17	2	.2	165	2				74.0	.3	161	2	.2	164	2		
	94.0	.3	1	2	.1	0	2				78.0	.4	129	2	.2	15	2		
	98.0	1.2	177	2	.2	75	2				82.0	.7	48	2	.2	6	2		
	102.0	.3	164	2	.1	96	2				86.0	.2	84	2	.1	132	2		
	106.0	1																	

TABLE 2 (continued)

LAT	LONG	INT 408	THETA 408	N 408	INT 610	THETA 610	N 610	SP.1.	DIF	LAT	LONG	INT 408	THETA 408	N 408	INT 610	THETA 610	N 610	SP.1.	DIF	
- 4.0	122.0	.8	14	2	.3	16	2			0.0	26.0	2.3	112	1	1.5	87	2	1.0	25	
	126.0	1.4	2	2	.3	161	2	3.6	21		28.0	1.5	132	2	1.3	85	2	0.4	47	
	129.2	2.1	12	2	.8	123	2	2.3	69		32.0	1.4	21	2	1.7	74	2	- 0.5	-53	
	156.0	1.0	179	2	.5	168	2	1.9	11		36.0	1.5	148	5	1.8	64	2	- 0.4	84	
	166.0	.5	33	2	.3	169	2				38.0	2.4	154	1	.3	65	2	5.3	89	
	172.0	.6	17	2	.4	17	2				40.0	.7	172	3	.7	74	2			
	176.0	.7	1	1	.1	15	2				42.0	1.7	163	1	.3	59	2	4.7	-76	
	180.0	.9	13	2	.0		2				44.0	1.1	3	3	.4	58	2	2.4	-55	
	184.0	2.3	105	1	.3	65	2	4.8	40		46.0	.9	7	1	.3	81	2			
	186.0				.2	89	2				48.0	1.4	102	3	1.2	92	2	0.2	10	
	192.0				.1	53	2				50.0	.9	95	1	1.5	48	2			
	198.0				.1	8	2				52.0	1.1	138	3	.6	82	2	1.4	56	
	202.0				.5	33	2				56.0	.4	120	5	.2	89	2			
- 3.8	175.7	.6	4	1							60.0	.7	121	2	.2	47	2			
- 3.6	50.8	2.2	40	1							62.0	.6	159	2						
	131.3	3.1	10	1	.9	179	2	3.1	11		64.0	.3	164	4	.2	146	2			
- 3.5	142.0	3.7	5	2							66.0	1.1	3	2						
- 3.3	146.2	1.7	54	2	.8	14	2	1.9	40		68.0	.6	3	4	.1	107	2			
	158.5	1.5	172	2	.1	72	2				70.0	.7	4	2	.5	136	2			
- 3.0	133.3	1.3	3	1	1.1	170	4	0.4	13		72.0	.6	10	1	.4	139	2			
	161.5	1.2	35	2	.7	29	2	1.3	6		74.0	1.7	9	2	.6	148	2	2.8	41	
- 2.8	50.3	1.8	39	1							76.0	2.4	174	1	.2	120	2			
- 2.6	150.4	2.1	172	2	.8	156	2	2.5	16		78.0	3.0	15	2	1.0	165	2	2.8	30	
- 2.4	81.2	3.2	178	2							80.0	2.9	17	2	1.1	22	2	2.5	- 5	
	126.8	1.1	4	2							82.0	1.6	27	2	.8	77	2	1.8	-50	
	153.7	1.7	177	2	.4	161	2	3.5	16		84.0	1.7	176	2	.4	86	2	3.7	90	
- 2.3	133.3	2.8	158	1	.9	164	2	2.9	- 6		86.0	.6	146	2	.1	0	2			
	144.0	3.5	27	2	.9	16	2	3.5	11		88.0	.3	15	2	.1	117	2			
- 2.0	24.0	3.1	160	3	.7	14	1	3.7	-34		90.0	.7	16	2	.1	110	2			
	28.0	3.0	166	2	.8	14	2	3.3	-28		92.0	.3	174	2	.1	80	2			
	32.0	2.5	157	2	.7	10	2	3.3	-33		94.0	.2	55	2	.3	102	2			
	36.0	2.7	159	2	.5	2	2	4.2	-23		96.0	.2	129	2	.2	50	2			
	40.0	2.3	165	2	.8	178	2	2.5	-13		98.0	.1	8	2	.2	5	2			
	44.0	1.5	163	2	.3	7	2	4.3	-24		100.0	.4	87	2	.2	85	2			
	48.0	.8	9	2	.4	25	2				102.0	.6	131	2	.4	91	2			
	50.0	3.8	47	2							104.0	.4	160	2	.3	100	2			
	52.0	.7	150	2	.3	165	2				106.0	.9	125	2	.4	82	2			
	56.0	.7	154	2	.2	151	2				106.8	1.0	174	11						
	60.0	.5	167	2	.2	162	2				108.0	1.6	110	2	.3	71	2	4.2	39	
	64.0	.5	135	2	.2	143	2				110.0	3.3	114	2	.6	39	2	4.2	75	
	68.0	.6	136	2	.1	173	2				112.0	2.9	58	2	.6	21	2	4.2	37	
	72.0	.3	4	2	.3	167	2				114.0	.5	8	2	.2	165	2			
	76.0	.0		2	.2	175	2				116.0	.6	123	2	.2	145	2			
	80.0	.3	158	2	.2	134	2				118.0	.4	47	2	.2	132	2			
	84.0	1.6	168	2	.5	169	2	2.8	- 1		120.0	1.2	50	2	.5	3	2	1.9	47	
	88.0	.3	164	2	.1	74	2				122.0	.8	15	2						
	92.0	.6	2	2	.2	103	2				124.0	1.3	23	2	.2	137	2			
	93.0	.8	35	2							126.0	2.2	28	2	1.0	123	2	1.9	85	
	100.0	.7	168	2	.5	80	2				128.0	2.0	33	2	1.0	139	2	1.8	74	
	104.0	1.2	41	2	.6	64	2	1.8	-23		128.5	2.5	33	2	1.2	128	2	1.8	85	
	108.0	.1	99	2	.2	148	2				130.0	1.4	48	2	1.0	140	4	0.7	88	
	111.8	2.8	119	2	.9	133	2	2.8	-14		132.0	.8	107	2	1.0	160	2			
	116.0	1.7	149	2	.2	94	2				134.0	.7	137	2	1.4	167	2			
	120.0	1.0	7	2	.5	137	2	1.6	50		136.0	1.8	1	2	.1	166	2			
	124.0	1.2	173	2	.1	152	2				138.0	3.0	12	2	1.1	8	4	2.5	- 4	
	128.0	.5	76	2	1.4	143	2				140.0	3.5	13	3	1.3	20	4	2.6	- 7	
	128.8	.9	105	2							142.0	4.0	15	2	1.1	26	5	3.1	-11	
	164.0	.6	50	1	.4	32	2				144.0	4.3	24	2	1.0	32	4	3.8	- 8	
	168.0	.5	53	2	.5	46	2				146.0	2.4	38	2	.5	48	4	3.8	-10	
	172.0	1.6	40	2	.4	24	2	3.8	16		147.4	2.0	1	1	.4	63	2	3.9	-62	
	176.0	1.0	79	2	.1	9	2				148.0	.2	107	2	.3	39	2			
	180.0	.6	132	2	.1	174	2				150.0	1.1	16	2	.6	146	2	1.8	50	
	182.0	.6	19	1	.2	16	2				152.0	1.4	16	2	.4	15	2	3.0	1	
- 1.8	141.0	4.2	12	2	1.0	20	2	3.6	- 8		154.0	1.9	15	2	.2	103	2			
- 1.7	130.8	2.2	163	2	1.2	171	2	1.6	- 8		156.0	1.1	169	2	.5	36	2	2.0	-47	
	164.2	.8	41	1							158.0	.4	63	2	.2	30	2			
- 1.6	94.3	.2	122	1	.5	89	2				160.0	1.1	15	2	.5	10	2	1.9	5	
	111.7	4.4	161	1							162.0	2.0	45	2	.3	26	2	4.7	19	
- 1.5	137.3	3.2	13	1	.5	7	2	4.5	6		164.0	2.4	47	2	.4	79	2	4.4	-32	
	165.4	2.2	59	3							166.0	1.7	34	1	.9	63	2	1.7	-29	
- 1.4	23.7				.7	19	1				168.0	1.0	48	2	.7	58	2	1.0	-10	
- 1.2	154.4				.4	7	1				172.0	.7	45	2	.4	21	2			
	160.5	1.8	4	2	.3	25	2	4.5	-21		174.0	.4	27	2	.3	5	2			
- 1.0	49.4	3.0	41	2							176.0	.6	12	2	.4	16	2			
	132.7	2.2	126	2	1.1	155	2	1.7	-29		178.0	.4	151	2	.1	73	2			
	146.0	2.0	40	2	.5	34	3	3.3	6		180.0	.5	28	2	.2	9	2			
	149.0	2.2	7	2	.4	121	2	4.4	66		182.0	.7	97	1	.1	77	2			
	152.4	2.2	4	2	.5	3	2	4.6	1		184.0	.2	146	1	.2	29	2			
- 0.8	59.6	1.1	173	15							186.0				.2	67	2			
	99.7	.3	72	2							192.0				.4	32	2			
	116.5	1.2	158	1							198.0				.2	48	2			
- 0.6	143.0	3.4	18	2	1.0	21	3	3.1	- 3		202.0				.4	44	2			
	155.6	1.9	169	2	.1	94	2			0.3	76.3	1.2	170	1						
- 0.5	134.6	.6	162	2							130.3	1.7	29	5	1.1	142	2	1.1	67	
- 0.4	44.5	2.6	16	2							136.4	2.0	178	2	.4	165	2	3.8	13	
- 0.2	67.4	.8	14	1							148.0	2.1	62	2	.4	73	2	4.1	-11	
	170.2	2.7	39	2	.9	30	2	2.9	9		0.5	151.0	1.0	15	2	.4	148	2	2.5	47
0.0	22.0	4.2	109	1	1.4	111	2	2.8	- 2		0.6	144.8	2.8	37	2					
	24.0	1.5	113	2	2.9	66	2	- 1.7	45		0.8	132.0	1.4	166	3	1.2	163	2	0.4	3
											154.2	2.3	179	2	.1	126	2			

TABLE 2 (continued)

LAT	LONG	INT 408	THETA 408	N 408	INT 610	THETA 610	N 610	SP.1.	DIF	LAT	LONG	INT 408	THETA 408	N 408	INT 610	THETA 610	N 610	SP.1.	DIF
1.0	142.0	3.4	10	2	1.1	40	2	2.8	-30	4.0	60.0	.8	6	2	.3	131	2		
	162.3	1.9	58	3	.2	80	2				64.0	.9	0	2	.3	134	2		
	167.3	1.7	55	3	.8	68	2	1.9	-13		68.0	1.2	9	2	.4	138	2	2.7	51
1.2	148.8	2.4	46	2	.9	75	2	2.3	-29		72.0	1.1	0	2	.2	141	2		
1.3	154.6				.8	66	1				76.0	2.1	173	2	.8	168	2	2.5	5
1.4	97.0	.7	67	2	.1	64	2				84.0	.7	128	1	.6	126	2		
	123.0	1.9	13	2	.7	98	2	2.7	-85		88.0	1.1	46	2	.2	88	2		
	134.0	2.2	9	3	1.4	139	2	1.2	50		92.0	1.1	169	2	.5	162	2	1.9	7
	157.5	2.3	20	3	.4	82	2	4.5	-62		96.0	.5	90	2	.6	68	2		
1.6	126.4	1.2	31	2	1.6	141	2	0.6	70		100.0	.7	160	2	.4	59	2		
	142.8	.5	163	2	1.2	43	3				104.0	.7	7	2	.3	91	2		
1.7	139.0	3.7	2	2	1.1	35	2	3.0	-33		108.0	.8	156	1	.6	72	2		
1.8	78.5	1.8	171	1	1.2	114	2	1.0	57		112.0	.4	19	2	.2	32	2		
	177.8	.4	63	1							116.0	.9	6	2	.2	2	2		
2.0	20.0	1.1	96	2	.5	78	1	2.2	18		120.0	1.6	61	2	.3	28	2	4.2	33
	24.0	2.6	77	2	.4	5	2	4.9	72		134.8	6.1	159	4	2.1	172	4	2.7	-13
	28.0	1.5	64	4	.5	1	2	2.9	63		154.4	1.0	1	2	.3	109	2	2.8	72
	32.0	1.4	48	2	.4	52	2	3.0	-4		168.0	.5	21	2	.5	39	2		
	40.0	1.0	85	2	.5	169	2	1.7	-84		172.0	.4	55	2	.6	133	2		
	42.0	.9	179	2	.6	167	2				176.0	.1	40	2	.5	60	2		
	46.0	1.1	29	2	.3	146	2	3.2	63		180.0	.6	59	2	.3	60	2		
	50.0	1.0	25	2	.4	155	2	2.0	50		184.0	.7	110	1	.1	161	2		
	54.0	.2	174	2	.2	152	2				186.0				.2	51	2		
	58.0	.6	153	2	.2	155	2				192.0				.2	47	2		
	62.0	.2	46	2	.2	169	2				198.0				.2	33	2		
	66.0	.4	166	2	.4	147	2				202.0				.2	40	2		
	70.0	.7	148	2	.4	94	2			4.2	129.3	2.6	117	2					
	74.0	.5	124	2	.5	126	2				149.0	2.4	52	1	1.3	53	4	1.5	-1
	82.0	1.3	0	2	1.2	145	2	0.2	35	4.3	46.0			.4	168	1			
	86.0	.3	0	2	.1	113	2			4.4	99.6	.5	84	2					
	90.0	.3	122	2	.2	63	2				139.7	3.7	9	2					
	90.6	.6	134	1							162.4	3.4	67	3	.5	67	2	4.6	0
	98.0	.5	29	2	.1	52	2			4.6	131.0	3.3	158	2	1.8	1	2	1.4	-23
	102.0	.7	176	2	.1	151	2			4.7	93.6	.7	95	2	.5	97	2		
	106.0	.5	173	2	.3	137	2				142.0	5.1	25	3	2.2	14	2	2.1	11
	110.0	1.4	29	3	.5	58	2	2.7	-29	5.0	139.8	4.1	168	4	2.0	177	2	1.8	-9
	114.0	1.4	1	2	.5	57	2	2.8	-56		144.0	4.9	28	2	2.1	25	2	2.1	3
	118.0	1.2	23	2	.8	174	2	0.9	29		147.0	5.2	61	2	2.1	39	2	2.2	22
	122.0	1.5	10	2	.3	93	2	3.9	-83		150.0	5.8	81	1	1.6	44	2	3.2	37
	128.0	1.3	11	2	1.3	166	2	0.1	25	5.2	132.4	6.0	163	2	1.8	170	2	3.0	-7
	135.6	2.3	154	3	.9	0	2	2.4	-26		137.0	5.3	158	1	1.9	167	2	2.5	-9
	146.6	1.8	49	2	1.0	68	2	1.4	-19	5.4	123.0	2.0	6	1	.7	170	2	2.5	16
	170.0	2.2	57	2	.3	12	2	5.1	45		153.0	1.7	73	2	1.3	52	4	0.7	21
	174.0	.8	74	2	.1	23	2			5.5	141.3	4.6	1	2					
	178.0	1.8	66	1	.3	71	2	4.9	-5		143.0	4.6	10	4	1.6	21	2	2.6	-11
	182.0	.3	135	1	.2	17	2			5.6	104.5	.4	14	2					
2.2	129.8	.7	166	2	1.2	170	2				126.0	3.3	147	2	.5	6	2	5.0	-39
	143.7	1.5	41	4	1.5	44	3	0.0	-3		160.8	2.1	57	2	1.1	72	2	1.6	-15
	152.8	1.8	5	2	.3	85	2	4.6	=8C		165.7	.2	90	2	.2	113	2		
	160.7	1.2	9	3	.9	49	2	0.7	-40	5.7	76.2	3.3	97	1	1.7	156	2	1.7	-59
2.4	102.0	.7	118	1							158.4	2.0	66	2	.6	57	3	3.1	9
	145.5				1.3	50	14			5.8	45.8	1.3	11	1					
2.6	152.7				.4	87	1				127.4	2.9	142	2					
2.7	131.5	.6	168	2	1.4	175	2			6.0	20.0	3.7	91	3	1.0	167	2	3.3	-76
	140.8	1.6	44	2	1.8	37	2	0.3	7		24.0	1.3	97	2	.5	2	2	2.5	-85
	156.0	2.4	34	2	.8	79	2	2.6	-45		28.0	1.3	72	2	.3	106	2	3.6	-34
3.0	19.3	2.3	26	1							32.0	1.5	62	2	.4	145	2	3.5	-83
	32.0	2.4	54	2	.6	89	2	3.4	-35		36.0	1.1	72	2	.4	154	2	2.5	-82
	36.0	2.6	52	2	.4	2	2	4.4	50		40.0	.4	76	2	.7	2	2		
	166.0	.9	50	2	.2	25	2				42.0	1.1	177	2	.6	168	2	1.4	9
3.3	133.2	3.3	156	2	2.0	171	2	1.3	-15		46.0	.2	179	2	.3	3	2		
	164.0	2.4	66	3	1.0	64	2	2.3	2		50.0	.9	175	2	.3	154	2		
3.4	123.0	1.5	9	2	1.0	3	2	1.2	6		54.0	.3	96	2	.5	7	2		
	138.0	3.3	0	2	1.8	16	2	1.6	-16		58.0	.4	29	2	.1	176	2		
	169.0	.6	81	2	.9	32	2				62.0	.5	50	2	.2	9	2		
3.5	34.6	.5	116	1							66.0	.7	158	1	.3	168	2		
	145.3	2.9	57	2	1.9	34	4	1.0	23		70.0	2.3	166	2	.3	129	2	4.8	37
	159.2	2.5	17	1	1.0	57	4	2.1	-40		82.0	.4	175	2	.8	105	2		
3.6	79.4	1.8	14	2	.5	130	2	2.9	64		86.0	1.3	163	2	.5	112	2	2.5	51
	126.0	1.7	113	1	1.5	146	2	0.4	-33		87.4	1.3	131	2	.7	97	2	1.6	34
	151.3	2.6	63	2	.9	54	2	2.7	9		94.0	1.8	154	2	.1	120	2		
	161.2	2.2	63	1	.9	55	2	2.3	8		98.0	1.0	73	2	.5	92	2	1.6	-19
3.7	127.0				1.2	159	1				102.0	.8	163	2	.4	25	2		
3.8	127.7	1.7	96	2	1.1	173	2	1.0	-77		106.0	1.1	19	2	.1	58	2		
	140.7	4.5	32	5	2.5	19	11	1.5	13		110.0	1.1	167	2	.8	58	2	0.7	-71
	142.5	4.1	43	2	2.3	23	3	1.4	20		114.0	.4	37	2	.4	19	2		
4.0	20.0	2.4	88	2	.2	3	2				118.0	1.2	165	1	.8	177	2	1.0	-12
	22.0	2.3	82	2	.7	165	2	2.9	-83		122.0	1.7	8	2	.3	147	2	4.4	41
	24.0	1.2	88	2	.4	167	2	3.0	-79		129.0	4.8	136	2	1.1	165	2	3.6	-29
	26.0	2.1	82	2	.3	75	2	4.8	7		134.7	3.2	129	1	2.3	145	2	0.8	-16
	28.0	1.8	78	2	.3	104	2	4.7	-26		138.6	4.2	147	2	1.8	154	1	2.1	-7
	30.0	2.6	68	2	1.0	78	2	2.5	-10		141.0	4.8	168	4	1.9	176	2	2.2	-8
	34.0	2.6	81	2	.2	19	2				156.0	1.1	64	2	.8	73	2	0.6	-9
	38.0	3.8	81	2	.5	167	2	5.0	-86		170.0	1.6	62	2	.6	41	2	2.6	21
	40.0	2.3	78	2	.3	164	2	5.1	-86		174.0	.3	133	2	.4	57	2		
	44.0	1.4	5	2	.3	120	2	4.3	65		178.0	.5	78	2	.4	40	2		
	46.7	.5	19	1							182.0	.6	76	1	.1	18	2		
	48.0	1.7	0	2	.2	143	2			6.3	139.0	4.6	163	3	1.7	158	2	2.5	5
	52.0	1.3																	

TABLE 2 (continued)

LAT	LONG	INT 408	THETA 408	N 408	INT 610	THETA 610	N 610	SP.I.	DIF	LAT	LONG	INT 408	THETA 408	N 408	INT 610	THETA 610	N 610	SP.I.	DIF	
12.0	72.0	.6	30	2	.1	154	2			14.0	178.0	1.1	58	2	.9	28	2	0.5	30	
	76.0	1.2	54	2	.3	138	2	3.4	-84		182.0	1.0	52	1	.3	170	2	2.8	62	
	80.0	.6	168	2	.2	132	2			14.2	136.2	1.3	177	2	.7	167	2	1.6	10	
	84.0	.2	155	2	.3	125	2				152.0	1.8	67	2	.9	131	2	1.7	-64	
	88.0	1.1	153	2	.1	171	2			14.3	91.6	1.1	44	1	.6	117	2	1.5	-73	
	92.0	.8	87	2	.1	146	2			14.4	133.0	1.2	155	2	.3	153	2	3.5	2	
	96.0	1.3	111	2	.1	72	2				142.0	1.7	148	2	.6	177	2	2.7	-29	
	100.0	.7	26	2	.3	86	2				144.7	2.3	163	2						
	104.0	.5	27	2	.5	136	2			14.5	128.8	.9	112	2	.8	154	2			
	108.0	.8	8	1	.1	115	2			14.6	139.6	1.5	146	3						
	112.0	1.6	160	2	.2	143	2			14.7	77.7	.8	28	1						
	116.0	.4	105	2	.7	7	2				133.5	1.1	164	1						
	120.0	1.2	16	2	.7	146	2	1.3	50		147.4	1.5	146	2	.7	151	2	1.7	-5	
	124.0	.9	54	2	.5	151	2			15.0	134.0	1.7	167	2	.6	160	2	2.7	7	
	127.4	1.8	98	2	1.1	150	2	1.3	-52		137.0	.8	2	2	.5	148	2			
	133.0	5.6	131	2	1.4	162	4	3.4	-31		145.2	1.9	140	1	.6	168	2	4.9	-28	
	136.4	2.5	138	2						15.2	150.0	.4	4	2	.5	122	2			
	142.6	3.8	163	4	.7	167	8	4.1	-4	15.3	100.7	.5	163	2						
	145.2	3.2	4	2	1.1	11	2	2.6	-7		130.6	1.6	139	2						
	148.0	3.6	14	2	1.2	179	2	2.7	15	15.4	165.0	4.1	54	1						
	152.0	1.7	140	2	1.1	165	3	1.0	-25	15.5	131.0	1.2	143	2	.1	13	2			
	155.4	3.2	95	2	1.2	143	6	2.4	-48	15.6	143.0	1.4	130	1	.4	164	2	3.2	-34	
	160.0	2.2	35	2	.9	124	2	2.3	-89	15.7	140.5	1.6	127	1	.3	152	2	4.4	-25	
	164.0	1.4	4	2	1.1	5	2	0.7	-1	15.8	21.5	2.9	79	2	1.0	170	2	2.6	89	
	168.0	2.1	13	3	.4	6	2	4.4	7		126.4	.8	21	1	.5	124	2			
	172.0	1.3	21	2	.8	11	2	1.4	10		134.8	.2	125	2						
	176.0	.3	97	2	.1	70	2				145.7	1.0	114	2						
	180.0	.3	80	2	.2	35	2			16.0	14.0	1.8	51	2	.5	134	2	3.5	-83	
	184.0	.4	59	1	.2	56	2				18.0	4.0	60	2	.6	151	2	4.7	89	
	186.0				.2	55	2				26.0	1.7	48	2	.2	119	2			
	192.0				.2	60	2				30.0	1.6	57	2	.2	129	2			
	198.0				.2	40	2				34.0	1.2	1	2	.1	174	2			
	202.0				.2	47	2				36.0	1.0	27	2	.2	177	2			
12.2	140.0	.9	128	2	.7	159	4				38.0	1.0	12	2	.2	10	1			
12.3	51.8				.3	123	1				40.0	.3	61	2	.5	177	2			
	88.0	.3	112	2							44.0	.9	0	2	.0		2			
	137.0	1.4	142	1							48.0	1.3	27	2	.1	151	2			
12.5	150.8	1.0	175	2	.9	160	2	0.3	15		52.0	.5	144	2	.4	159	2			
12.6	129.5	3.4	121	1	1.3	141	2	2.3	-20		56.0	.3	164	2	.1	162	2			
12.7	102.7	.5	41	2							60.0	.3	9	2	.1	37	2			
	134.2	3.1	127	2	.8	167	2	3.3	-40		64.0	.5	16	2	.1	135	2			
	137.5	.9	178	2	.8	163	4				68.0	.2	80	2	.3	111	2			
13.0	97.3	.5	127	2							72.0	.3	38	1	.2	42	2			
	143.7	3.1	168	2	.5	3	2	4.4	-15		76.0	1.3	15	2	.2	138	2			
13.2	128.0	1.0	80	2	1.3	134	2	0.6	-54		80.0	.4	74	2	.2	116	2			
	146.4	2.5	177	4	.9	176	2	2.7	1		84.0	.4	55	2	.2	34	2			
13.3	141.0	2.2	146	2	.6	174	2	3.1	-28		88.0	.6	10	2	.4	164	2			
13.5	125.0	.6	5	2	.6	126	2				92.0	2.3	105	2	.7	126	2	2.9	-21	
	135.2	.8	142	2	.7	171	2				96.0	1.3	54	2	.1	165	2			
13.6	42.0	2.1	19	1							100.0	.8	51	2	.1	14	2			
	149.0	.9	20	2	.8	153	2				104.0	.5	72	2	.3	144	3			
13.7	138.6	2.3	173	2	.7	163	2	3.0	10		108.0	.7	17	2	.1	20	2			
13.8	132.0	2.6	134	2	1.0	155	4	2.4	-21		112.0	.7	162	2	.3	24	2			
14.0	16.0	3.1	96	2	1.0	175	2	2.7	-79		116.0	.3	90	2	.5	161	2			
	17.8	3.2	89	2	1.0	168	2	2.9	-79		120.0	1.9	147	2	.5	105	2	3.3	42	
	20.0	.8	77	2	.9	1	2				124.0	.9	5	2	.2	133	2			
	24.0	.8	50	2	.3	7	2				128.0	.8	56	2	.3	122	1			
	28.0	2.3	56	2	.3	94	2	4.8	-38		132.0	1.4	154	2	.3	159	2	3.8	-5	
	32.0	1.0	178	2	.4	173	2	2.5	5		136.0	1.6	24	2	.6	147	2	2.4	57	
	36.0	1.2	41	2	.2	13	2				138.0	.9	160	2	.4	147	4			
	40.0	1.1	19	2	.3	160	2	3.6	39		140.0	1.5	128	2	.4	161	4	3.5	-33	
	42.0	.7	95	2	.0		2				144.0	.6	124	2	.6	163	3			
	46.0	2.1	98	2	.2	179	2				148.0	.6	78	2	.3	145	2			
	50.0	1.9	97	2	.3	151	2	4.9	-54		152.0	.9	104	2	.1	96	2			
	54.0	1.4	91	2	.2	140	2				156.0	.4	100	2	.3	36	2			
	58.0	1.5	71	2	.1	135	2				160.0	.3	33	2	.7	121	2			
	62.0	.6	39	2	.3	135	2				164.0	.3	120	2	.9	161	2			
	66.0	.4	4	2	.1	147	2				168.0	3.7	18	2	.7	21	2	4.3	-3	
	70.0	.5	11	2	.1	64	2				172.0	2.4	12	2	1.0	16	2	2.2	-4	
	74.0	.5	32	2	.1	154	2				176.0	.1	97	2	.7	10	1			
	78.0	.3	29	2	.2	120	2				180.0	.8	12	1	.2	55	2			
	82.0	.3	29	2	.3	56	2				184.0	.6	83	1	.2	49	2			
	86.0	.2	38	3	.3	52	2				188.0				.2	38	2			
	90.0	1.4	107	2	.2	10	2				192.0				.2	70	2			
	94.0	.4	77	2	.0		2				198.0				.2	39	2			
	98.0	.8	71	2	.1	141	2			16.2	92.3	1.4	119	1	.4	145	2	3.4	-26	
	102.0	.7	27	2	.4	165	2				95.2	.4	117	2	.2	179	2			
	106.0	.1	45	2	.1	84	3				148.3	.6	40	2	.3	149	2			
	110.0	.3	11	2	.3	16	2			16.5	135.7	.7	47	2	.8	132	2			
	114.0	.4	154	2	.3	35	2			16.6	132.7	1.7	173	2	.7	135	2	2.3	38	
	118.0	1.9	7	2	.5	41	2	3.5	-34	16.8	140.0				.4	157	1			
	122.0	.6	71	3	.5	129	2				144.0				.6	155	2			
	127.0	1.5	73	2	.9	132	2	1.3	-59	17.0	40.2	1.2	16	1						
	130.0	2.4	135	12	.9	159	7	2.4	-24	17.2	133.4	1.4	15	3	.6	134	2	2.1	61	
	154.2	2.6	66	10	1.0	126	2	2.4	-60		146.5	.7	68	2	.6	149	2			
	158.0	2.8	2	2	1.0	95	17	2.5	87	17.3	136.5	2.1	24	1						
	162.0	1.5	112	2	1.1	153	2	0.6	-41		141.7	1.6	138	2						
	166.0	2.4	167	2	.7	7	2	3.0	-20		140.2									
	170.0	2.5	13	2	1.0	26	2	2.2	-13	17.5	124.4	.8	163	3	.6	86	2			
	174.0	.8	170	2	1.1	26	2			17.7	125.8	.6	149	3	.9	86	2			

TABLE 2 (continued)

LAT	LONG	INT 408	THETA 408	N 408	INT 610	THETA 610	N 610	SP.I.	DIF	LAT	LONG	INT 408	THETA 408	N 408	INT 610	THETA 610	N 610	SP.I.	DIF
18.0	12.0	1.7	87	4	.2	156	2			20.0	112.0	.7	23	2	.2	112	2		
	16.0	2.5	49	4	1.1	157	2	2.1	72		116.0	.9	22	2	.7	126	3		
	20.0	1.7	58	4	.8	162	2	2.0	76		120.0	.5	20	2	.2	12	3		
	24.0	1.8	39	2	.2	152	2				124.0	1.1	40	2	.2	137	2		
	28.0	1.6	56	2	.4	166	2	3.7	70		128.0	1.9	16	2	.9	36	2	2.0	-20
	32.0	.9	50	2	.3	1	4				133.3	1.7	176	2	.3	111	4	4.2	65
	36.0	1.0	5	1	.2	44	4				136.0	1.1	168	2	.5	101	4	1.9	67
	39.8	1.1	27	1	.4	3	2	2.6	24		140.0	1.6	23	2	.3	4	4	4.6	19
	40.0	.5	36	2	.3	24	2				144.0	.9	52	2	.3	155	4		
	42.0	.7	69	2	.6	0	2				148.0	.7	69	2	.6	148	3		
	46.0	.7	100	2	.0	0	2				152.0	1.9	43	2	.1	178	2		
	50.0	.6	86	2	.1	128	2				153.7	2.6	23	25	.1	156	8		
	54.0	1.1	81	2	.2	52	2				156.0	1.0	64	2	.4	141	5	2.2	-77
	58.0	.6	73	2	.2	152	2				160.0	1.4	56	2	.5	96	4	2.5	-40
	62.0	.3	52	2	.1	0	2				164.0	3.5	173	2	1.1	171	7	3.0	2
	66.0	1.6	18	2	.0	0	4				168.0	4.4	19	2	.8	8	4	4.3	11
	70.0	.6	32	2	.1	53	2				172.0	1.9	62	2	.5	18	2	3.2	44
	74.0	.7	38	2	.4	83	2				176.0	.9	81	2	.1	158	2		
	78.0	.4	32	2	.3	134	2				180.0	.6	61	2	.5	27	2		
	82.0	.1	175	2	.2	151	2				184.0	.7	90	1	.2	142	2		
	86.0	.7	6	2	.4	163	2				188.0				.1	146	2		
	90.0	1.6	23	2	.4	158	2	3.5	45		192.0				.3	129	2		
	94.0	.6	96	2	.4	134	2				198.0				.2	23	2		
	98.0	.4	109	2							206.8	.3	92	1					
	99.0	.5	159	2						20.5	15.0			.1	5	1			
	102.0	1.2	87	2	.2	38	2				131.0	.1	121	2	.2	36	2		
	106.0	.9	45	2	.1	109	2			20.6	51.3	2.0	109	1					
	110.0	1.5	4	2	.2	42	2			21.0	160.8	4.0	153	1					
	114.0	1.2	177	2	.4	61	2	2.5	-64	21.3	177.8			.5	84	1			
	118.0	.6	176	2	.4	123	2			21.5	132.0	.4	172	2	.1	32	2		
	122.0	1.3	179	2	.3	20	2	3.4	-21	21.6	38.0	1.3	21	1					
	134.2	1.5	21	2	.7	127	1	1.8	74	21.7	77.8			.3	138	1			
	138.0	1.8	26	2	.5	119	2	3.0	87	21.8	208.4			.6	92	1			
	142.0	1.1	137	2	.3	174	2	3.2	-37	22.0	8.0	1.1	77	3	.2	45	2		
	144.7	.8	64	2	.4	164	2				12.0	1.1	71	4	.2	43	2		
	150.0	1.2	46	2	.4	143	2	2.8	83		16.0	1.6	94	4	.4	173	2	3.4	-79
	154.0	2.4	36	2	.1	100	2				20.0	1.6	61	4	.2	172	2		
	158.0	.8	114	1	.1	158	2				24.0	2.0	53	2	.2	17	2		
	162.0	2.5	74	2	1.0	133	2	2.2	-59		28.0	1.9	56	2	.4	8	2	4.2	48
	165.5				.7	27	1				32.0	.8	55	2	.4	4	2		
	166.0	3.2	51	2	1.2	29	1	2.5	22		36.0	1.0	19	2	.4	8	2	2.3	11
	170.0	4.5	9	3	.7	6	2	4.6	3		40.0	.6	38	2	.6	167	2		
	174.0	.8	16	3	.6	13	2				42.0	.9	68	2	.3	169	2		
	178.0	.7	40	3	.3	28	2				46.0	.2	75	2	.7	165	2		
	182.0	.7	88	1	.3	34	2				50.0	.7	46	2					
18.2	127.2	.6	85	3	.9	64	2				54.0	1.1	59	2					
	131.4	1.2	162	2	.6	102	2	1.5	60		58.0	1.2	79	3	.2	151	2		
18.6	135.0	1.7	163	1	.7	122	2	2.3	41		62.0	1.2	88	2	.1	133	2		
18.7	132.0	1.6	169	2	.6	98	2	2.4	71		81.5				.1	170	1		
18.8	128.5	.9	61	3	.8	53	2				132.5				.0		1		
19.0	142.8	.4	67	2	.3	166	2				166.0				.8	174	2		
19.3	132.7	1.6	170	2	.5	103	2	3.1	67		170.0	3.8	41	4	.6	16	1	4.4	25
19.5	129.8	.8	29	3	.7	37	2				174.0	1.3	106	2	.1	80	2		
19.6	183.8	.8	88	1							178.0	.3	129	2	.4	75	1		
19.8	135.8				.8	130	1				182.0	.5	74	2	.7	42	2		
										23.3	37.2	1.6	19	1					
20.0	10.0	.6	80	2	.1	70	2			23.8	15.8	1.9	23	1					
	12.0	1.0	65	2	.2	171	2				19.4				.6	0	2		
	14.0	1.8	75	2	.2	28	1			24.0	6.0	1.7	58	2	.3	91	2	4.6	-33
	16.0	2.0	71	2	.3	151	2	4.4	-80		8.0	1.3	91	2	.1	17	2		
	18.0	1.3	84	2	.0	0	2				9.3	1.8	48	1					
	20.0	2.1	85	2	.3	136	2	4.7	-51		10.0	.7	59	2	.0	0	2		
	22.0	1.9	66	2	.3	23	2	4.4	43		10.2				.1	27	1		
	24.0	1.4	44	2	.3	151	2	4.1	73		12.0	1.6	80	2	.2	4	2		
	26.0	.2	121	2	.3	113	2				14.0	1.3	84	2	.2	50	2		
	28.0	.4	82	2	.6	106	2				16.0	1.9	96	2	.5	21	2	3.2	75
	30.0	.9	80	2	.5	113	2				18.0	1.2	95	2	.6	2	2	1.5	-87
	32.0	1.0	60	2	.1	174	2				20.0	2.1	93	2					
	34.0	1.0	31	2	.4	178	2	2.6	33		24.0	2.4	107	2	.7	29	2	3.1	78
	36.0	1.3	32	2	.3	160	2	4.1	52		28.0	.5	121	2	.4	146	2		
	38.0	.6	10	2	.3	170	2				32.0	.4	15	2	.6	161	2		
	40.0	.9	52	2	.2	57	2				36.0	1.6	26	2	.4	1	2	3.4	25
	44.0	.1	2	2	.0	0	2				44.0	.1	30	2	.5	174	2		
	48.0	.6	36	2	.1	122	2				48.0	.5	31	2	.2	169	2		
	52.0	1.1	21	2	.2	127	2				52.0	1.2	33	2	.0	0	2		
	56.0	1.2	40	2	.1	169	2				56.0	1.1	41	2	.1	51	2		
	60.0	1.5	47	2	.2	123	2				60.0	.9	57	2	.2	135	2		
	64.0	.8	34	2	.2	109	2				64.0	.9	48	2	.3	103	2		
	68.0	.7	39	2	.2	65	2				68.0	1.0	31	2	.1	125	2		
	72.0	.5	38	2	.4	67	2				72.0	.5	21	2	.4	74	2		
	75.8				.4	99	1				76.0	.3	45	2	.5	96	2		
	76.0	.8	48	2	.3	152	1				80.0	.6	18	2	.1	139	2		
	80.0	.5	89	2	.4	6	2				84.0	.9	158	2	.2	3	2		
	84.0	.3	27	2	.4	170	2				88.0	.3	30	2					
	88.0	.9	48	2	.3	174	2				92.0	.8	177	2					
	92.0	.9	110	2	.3	121	2				96.0	.7	159	2					
	96.0	.6	7	2	.2	117	2				100.0	.7	82	2	.2	35	4		
	100.0	.9	66	2	.3	129	2				104.0	.9	37	2	.3	163	4		
	104.0	.4	27	2	.0	0	3				108.0	.5	29	2	.1	117	4		
	108.0	1.3	24	2	.2	88	4				112.0	.4	1	2	.1	53	2		

TABLE 2 (continued)

LAT	LONG	INT 408	THETA 408	N 408	INT 610	THETA 610	N 610	SP.1.	DIF	LAT	LONG	INT 408	THETA 408	N 408	INT 610	THETA 610	N 610	SP.1.	DIF	
24.0	116.0	.8	2	2	.2	126	2			28.0	136.0	.9	176	2	.3	24	2			
	120.0	1.2	10	2	.1	68	2				140.0	1.2	4	2	.1	16	2			
	124.0	.7	30	2	.3	54	2				144.0	.7	12	2	.4	22	2			
	128.0	.8	14	2	.3	52	2				148.0	1.0	178	2	.6	34	2	1.4	-36	
	132.0	1.8	44	2	.3	144	2	4.6	80		152.0	1.3	165	2	.2	57	2			
	136.0	1.3	41	2	.2	1	2				156.0	.9	166	1	.2	134	2			
	139.8				.3	36	2				160.0	.5	1	2	.4	30	2			
	140.0	1.3	14	2							164.0	.6	24	2	.1	44	4			
	144.0	1.0	13	2	.3	40	2	2.9	-27		168.0	3.0	78	2	.6	61	4	4.0	17	
	148.0	1.0	24	2	.7	38	2	0.9	-14		188.0				.5	43	2			
	152.0	.6	19	2	.1	68	2				192.0				.2	8	2			
	156.0	.8	6	2	.1	143	2				196.0				.1	82	2			
	160.0	.4	43	2	.3	33	2			28.3	42.0	1.7	8	2						
	188.0				.2	70	2			28.5	36.0	.3	61	2						
	192.0				.1	53	2			28.6	19.0	1.0	115	1						
	196.0				.2	175	2			28.7	32.0	1.3	14	2						
24.2	36.8	1.3	9	6						28.8	11.4				.8	87	2			
24.3	88.3				.4	161	1			29.4	123.0	1.1	5	18	.1	173	12			
24.4	9.3				.1	168	3			29.7	46.4	.7	14	2						
25.2	34.0	.7	11	2																
25.6	111.4	.6	24	1						30.0	0.0	.7	64	2						
26.0	4.0	1.2	74	2	.2	2	2				4.0	1.5	79	2	.2	174	2			
	8.0	1.2	72	2	.3	18	2	3.7	54		8.0	.4	16	2	.4	83	2			
	12.0	1.3	85	4							12.0	.3	123	4	.8	111	2			
	16.0	2.0	100	2	.5	178	2	3.7	-78		16.0	1.7	78	4	1.0	162	2	1.4	-84	
	20.0	.7	134	4	1.2	11	2				20.0	1.6	119	2	1.3	170	2	0.4	-51	
	24.0	.3	68	2	1.0	24	2				24.0	1.3	6	2	.3	47	2	3.8	-41	
	28.0	.2	175	2	.3	9	2				28.0	1.0	27	2	.2	134	2			
	32.0	.9	31	2	.1	176	2				32.0	1.3	60	2	.4	167	2	3.0	73	
	36.0	.7	24	2	.2	18	2				36.0	.7	35	2	.2	37	2			
	40.0	1.3	24	2	.5	169	2	2.3	35		40.0	.8	103	2	.7	70	2			
	42.0	.8	16	2	.5	166	2				42.0	.3	28	2	.3	108	2			
	46.0	.9	3	2	.2	11	2				46.0	.9	17	2	.3	84	2			
	50.0	.9	16	2	.2	145	2				50.0	.6	12	2	.7	70	2			
	54.0	.8	9	2	.1	158	2				54.0	.4	18	2	.1	90	2			
	58.0	1.0	29	2	.1	130	2				58.0	.7	29	2	.4	117	2			
	62.0	.8	93	2	.3	113	2				62.0	.8	39	2	.2	179	2			
	174.0	2.5	104	1	.2	69	2				66.0	1.0	43	2	.2	135	2			
	174.0	1.2	114	2	.2	19	2				70.0	1.1	50	2	.0		3			
	178.0	1.2	114	2	.5	30	2	2.4	84		74.0	1.0	50	2	.3	154	2	3.1	76	
	182.0	.9	124	2	.4	2	2				78.0	.6	69	2	.3	165	2			
26.6	25.0				.5	42	2				82.0	.2	51	2	.4	171	2			
	38.0	1.3	19	2							86.0	.4	39	2	.2	161	2			
27.0	106.0				.2	116	1				170.0	3.0	109	2	.3	64	1	5.7	45	
27.2	16.5				.5	0	2				174.0	1.1	154	2	.2	92	2			
27.4	123.0	1.0	14	815	.2	16	390				178.0	1.1	15	2	.4	17	1	2.3	-2	
27.5	156.0	1.5	161	1							182.0	.4	0	2	.3	71	1			
28.0	2.0	1.3	47	2	.3	88	2	3.9	-41	30.2	165.3	1.3	0	1						
	4.0	1.2	59	2	.2	8	2				30.3	36.2	1.0	34	2					
	6.0	1.3	38	1	.1	28	2				30.8	209.0	.4	38	1					
	8.0	1.6	85	2	.2	12	2				31.0	50.8	1.0	21	1					
	10.0	1.7	37	2	.4	172	3	3.6	45		31.3	33.2	1.7	19	1					
	12.0	.8	90	2	.3	93	3				31.4	122.8	.9	21	20					
	14.0	2.1	44	2	.8	142	2	2.5	82		133.7				.2	15	13			
	16.0	2.0	91	2	.6	175	2	3.0	-84		31.5	9.2			.2	94	1			
	18.0	.2	78	2							31.8	40.6	.4	162	2	.7	104	3		
	20.0	2.1	125	2	1.0	169	2	1.8	-44		32.0	0.0	.8	72	2					
	22.0	.6	98	2	.5	168	3					2.0	1.2	70	2					
	24.0	.6	99	2	.6	2	2					4.0	1.5	76	2	.8	29	2	1.5	47
	26.0	.5	178	2	.5	113	2					6.0	1.2	86	2	.9	50	2	0.6	38
	28.0	.7	31	2	.3	177	2					8.0	1.4	113	2	.9	63	2	1.3	50
	30.0	1.6	36	2	.2	132	2					10.0	.3	2	2					
	32.0	1.2	46	2	.4	27	2	2.9	19			12.0	1.1	106	2	1.1	160	2	-0.1	-54
	34.0	.6	28	2	.4	176	2					14.0	1.8	75	2					
	36.0	1.3	26	2	.3	90	2	3.7	-64			16.0	.9	82	3	.8	130	2		
	38.0	.8	13	2	.4	6	2					18.0	2.0	96	2					
	40.0	1.5	45	2	.3	127	2	4.2	-82			20.0	2.5	117	3	.9	174	3	2.5	-57
	44.0	1.2	49	2	.1	163	2					22.0	1.5	179	2	.5	7	3	2.7	-8
	48.0	.6	57	2	.3	135	2					24.0	.5	137	2	.5	24	1		
	52.0	1.2	39	2	.3	67	2	3.4	-28			26.0	1.2	6	2	.4	4	2	2.7	2
	56.0	1.2	39	2	.0	2	2					28.0	1.2	47	3	.2	179	2		
	60.0	1.1	35	2	.1	111	2					30.0	1.0	33	2	.5	168	2	1.4	45
	64.0	1.0	59	2	.1	162	2					32.0	.8	55	2	.8	162	2		
	68.0	.7	59	2	.2	131	2					36.0	.2	94	3	.4	19	2		
	72.0	.2	45	2	.2	110	2					38.0	.2	108	1	.4	69	2		
	76.0	.4	7	2	.0	2	2					40.0	.6	136	2	.2	30	2		
	80.0	.8	168	2	.2	30	2					44.0	.9	54	4	.4	33	2		
	84.0	.3	16	2								48.0	1.5	48	2	.5	29	2	2.6	19
	88.0	.9	8	2	.8	16	2					52.0	1.6	43	2	.1	28	2		
	92.0	.9	46	2	.4	161	2					56.0	1.1	36	2	.1	87	2		
	96.0	.3	165	2	.2	109	2					60.0	1.1	59	2	.3	149	2	3.6	90
	100.0	.7	17	2	.3	39	2					64.0	1.0	58	2	.1	139	2		
	104.0	.4	155	2	.5	9	2					68.0	1.1	68	2	.2	2	2		
	108.0	.3	0	2	.2	168	2					72.0	.3	84	2	.4	78	2		
	112.0	.6	15	2	.2	158	2					76.0	.3	127	2	.1	82	2		
	116.0	1.0	1	2	.1	147	2					80.0	.4	39	2	.1	23	2		
	120.0	1.3	0	2	.2	143	2					84.0	.2	57	2	.2	14	2		
	124.0	1.5	90	1	.2	100	2					88.0	.2	133	2	.2	106	2		
	128.0	1.3	27	2	.5	27	2	2.2	0			92.0	1.1	178	2	.7	14	2	1.2	-16
	132.0	.5	48	2	.2	5	2					96.0	.4	2	2	.6	151	2		

TABLE 2 (continued)

LAT	LONG	INT 408	THETA 408	N 408	INT 610	THETA 610	N 610	SP.I.	DIF	LAT	LONG	INT 408	THETA 408	N 408	INT 610	THETA 610	N 610	SP.I.	DIF
32.0	100.0	1.1	13	2	.1	135	2			36.0	60.0	1.1	52	3	.2	22	2		
	104.0	.8	155	2	.2	173	2				64.0	.5	111	2	.5	36	2		
	108.0	1.0	0	2	.1	0	1				68.0	.3	101	2	.1	24	2		
	112.0	.7	172	2	.3	141	2				72.0	.4	143	2	.3	170	2		
	116.0	1.0	127	2	.2	79	2				76.0	.2	132	2	.7	172	1		
	120.0	.9	82	2	.4	93	2				80.0	1.1	96	2	.3	166	2	3.6	-70
	124.0	1.8	178	2	.3	11	2				84.0	.8	77	2	.3	2	2		
	128.0	1.3	82	2	.2	106	2	4.8	-13		88.0	.2	173	2	.2	161	2		
	132.0	1.1	70	2	.2	65	2				92.0	.5	179	2	.0	2	2		
	136.0	.8	34	2	.1	52	2				96.0	1.8	155	2	.2	97	2		
	140.0	.9	9	2	.3	65	2				100.0	1.4	21	2	.2	158	2		
	144.0	1.2	13	2	.3	73	2	3.4	-60		104.0	1.0	173	3	.3	150	2	3.2	23
	148.0	1.0	7	2	.3	49	2	3.1	-42		108.0	1.2	145	2	.5	137	2	2.4	8
	152.0	.3	14	2	.5	111	2				112.0	.8	131	2	.1	95	2		
	156.0	.8	139	2	.6	158	2				116.0	1.0	86	2	.3	124	2	3.3	-38
	160.0	.9	177	2	.4	6	2				120.0	1.2	35	2	.2	69	2		
	164.0	.5	152	2	.4	173	2				124.0	.7	152	2	.3	8	2		
	168.0	2.7	105	2	.4	55	2	4.8	50		128.0	.8	112	2	.3	109	2		
	172.0	2.1	131	2	.4	84	4	4.3	47		136.0	1.1	47	2	.1	96	2		
	176.0	1.0	124	2	.4	37	3	2.5	87		140.0	1.1	46	2	.1	20	3		
	180.0	.3	140	2	.3	44	1				144.0	.5	39	2	.1	65	2		
	184.0	.7	131	2	.3	66	1				148.0	1.4	145	2	.3	99	2	3.6	46
	188.0				.2	51	2				152.0	1.5	23	2	.6	160	2	2.4	43
	192.0				.1	158	2				156.0	.8	135	2	.7	1	2		
	196.0				.1	25	2				160.0	2.5	154	2	.2	43	2		
	358.0	1.4	45	2							164.0	1.4	148	2	.6	16	2	2.1	-48
32.7	23.5				.4	20	1				168.0	2.7	100	2	.5	77	4	4.2	23
33.0	32.3	2.1	11	1							172.0	1.4	71	1	.6	62	2	2.1	9
	45.0	.9	55	2							176.0	1.6	47	2	.4	34	2	3.4	13
33.3	141.3	.9	14	1							180.0	1.0	112	2	.2	81	2		
34.0	0.0	.6	81	2							184.0	.6	43	2	.1	122	2		
	4.0	.8	92	3	1.3	28	2				192.0				.1	127	2		
	8.0	1.8	90	2	.8	45	2	2.0	45		194.4	.8	156	71					
	12.0	.7	141	2	.4	5	2				196.0				.2	64	4		
	16.0	.3	107	2	.4	176	2				354.0	2.7	46	2					
	20.0	1.1	109	2	.6	1	3	1.7	-72		356.0	1.3	48	2					
	22.0	.6	14	2	.1	116	3				358.0	2.2	27	2					
	24.0	.5	63	2	.4	2	2			36.5	27.0	.6	67	1					
	26.0	1.1	46	2	.4	10	2	4.6	36	36.6	43.7	1.3	12	2					
	30.0	.9	54	2	.4	176	2			36.7	25.8	1.8	26	1					
	31.8	2.0	7	1	.5	10	2	3.7	-3	37.0	125.7	.4	146	2					
	32.0	.3	58	2						37.2	56.2	.9	124	1					
	34.0	.6	158	2	.5	120	2			37.3	121.3	.7	5	2					
	36.0	.9	19	2	.3	120	2			37.5	30.0	1.7	16	1					
	38.0	.3	98	2	.7	105	2			37.7	48.5	.8	36	2					
	40.0	.6	121	2	.1	178	2			38.0	0.0	1.3	71	2					
	42.0	.8	40	2	.3	40	2				4.0	1.8	71	2					
	46.0	1.0	32	2	.6	25	2	1.3	7		8.0	.3	127	2	.3	116	2	0.8	-47
	50.0	.9	39	2	.1	58	2				12.0	1.4	130	2	1.0	177	3		
	54.0	.9	41	2	.2	38	2				16.0	1.4	131	2	.6	22	2	2.1	-71
	58.0	.2	24	2	.4	61	2				20.0	.9	66	2	.9	27	2		
	62.0	.3	95	2	.2	49	2				24.0	1.6	67	2	.1	84	2		
	66.0	.8	37	2	.2	22	2				28.0	1.3	84	2	.2	129	2		
	70.0	.5	55	2	.2	159	2				32.0	1.1	92	2	.4	173	3	2.6	-81
	74.0	.5	71	2	.1	96	2				36.0	.9	71	2	.2	7	2		
	78.0	.6	46	2	.4	140	2				40.0	.1	131	2	.3	126	2		
	82.0	1.4	43	2	.2	129	4				44.0	.4	80	2	.3	125	2		
	86.0	.1	66	2							48.0	.3	23	2	.2	7	2		
	97.5				.3	163	1				52.0	.7	66	3	.2	89	2		
34.7	74.0	.4	77	1							56.0	.3	37	2	.2	105	2		
35.3	39.0	.7	41	2							60.0	.6	46	2	.2	141	2		
	143.3				.3	11	1				64.0	.1	125	2	.2	146	2		
35.4	122.5	.7	4	16	.2	23	12				68.0	.3	109	2	.2	19	2		
35.7	129.6	.8	103	2							72.0	.4	87	2	.3	102	2		
35.8	31.0	1.8	11	1							76.0	.5	57	2	.3	93	2		
	72.0				.2	170	1				80.0	.5	84	2	.1	105	2		
36.0	0.0	1.1	52	2							84.0	.4	29	2	.4	133	2		
	2.0	1.0	23	2							88.0	.5	107	2	.2	142	2		
	4.0	1.7	53	2	1.2	35	2	0.8	18		352.0	.3	31	2					
	6.0	1.0	36	2	1.0	48	2	-0.1	-12		356.0	.7	162	2					
	8.0	1.2	142	3	.2	87	2			38.4	29.4	1.7	17	1					
	10.0	1.4	16	2	.2	152	2				38.5	213.6	.3	61	1				
	12.0	.9	125	2	.6	170	3				38.7	125.4	1.3	145	2				
	14.0	.8	158	2							39.0	37.4	.2	72	2				
	16.0	2.2	123	2	.8	3	2	2.4	-60		39.3	29.0	2.0	19	1				
	18.0	.6	163	2							39.7	133.4	.5	91	2				
	20.0	.4	91	2	.4	0	2			40.0	0.0	1.8	48	2					
	22.0	1.1	28	2	.1	103	2				4.0	.7	70	2					
	24.0	1.5	88	2	.6	166	2	2.5	-78		6.0	.6	20	2	.5	94	2		
	26.0	.6	52	2	.5	10	2				8.0	1.4	0	2	.3	121	2	4.0	59
	28.0	1.2	63	2	.2	13	2				10.0	1.0	10	2	.7	4	2	1.0	6
	30.0	.3	55	2	.6	36	1				12.0	1.2	12	2	.7	13	3	1.5	-1
	32.0	.3	142	2	.3	43	2				14.0	.4	39	2					
	34.0	.1	172	2	.1	14	2				16.0	.8	161	2	.5	29	2		
	38.0	.2	155	2	.5	170	2				18.0	1.0	166	2					
	40.0	.6	22	1	.3	171	2				20.0	1.8	10	2	.5	38	2	3.2	-28
	44.0	1.0	47	2	.6	162	2	1.2	65		22.0	2.1	32	2	.3	56	2	4.5	-24
	48.0	.9	64	2	.1	48	2				24.0	2.2	43	2	.3	1	2	4.7	42
	52.0	2.4	57	2	.4	58	2	4.6	-1		26.0	1.6	48	2	.3	85	2	4.3	-37
	56.0	1.2	68	2	.2	122	2												

TABLE 2 (continued)

LAT	LONG	INT 408	THETA 408	N 408	INT 610	THETA 610	N 610	SP.1.	DIF	LAT	LONG	INT 408	THETA 408	N 408	INT 610	THETA 610	N 610	SP.1.	DIF
40.0	28.0	2.0	42	2	+2	85	2			44.0	0.0	.6	62	2					
	30.0	1.1	97	2	+2	135	2				8.0	.8	20	2	.4	42	3		
	32.0	.7	7	1	+5	174	2				12.0	1.6	29	2	.9	30	2	1.5	-1
	34.0	.4	173	2	+1	128	2				16.0	1.9	164	1	.1	79	2		
	36.0	.6	19	2	+4	140	2				20.0	.8	13	2	.2	11	2		
	38.0	.2	160	2	+2	164	2				24.0	1.5	38	2	.5	68	2	2.7	-30
	40.0	1.2	24	2	+4	125	2	2.7	79		28.0	.9	45	2	.7	136	2		
	42.3	1.2	19	2	+1	84	2				32.0	1.3	31	2	.6	130	3	2.0	81
	44.0	.5	37	2	+2	158	2				36.0	1.8	158	2	.6	48	1	2.7	-70
	48.0	.3	75	2	+6	174	2				40.0	2.0	147	2	.2	106	2		
	52.0	1.2	64	2	+1	36	2				44.0	1.1	176	2	.4	123	2	2.7	53
	56.0	1.9	58	2	+1	61	2				48.0	1.3	7	2	.4	158	2	3.0	29
	60.0	.1	45	2	+2	60	2				52.0	.9	66	2	.1	24	2		
	64.0	.4	84	2	+3	162	2				56.0	1.2	59	2	.2	113	2		
	68.0	1.3	50	2	+2	171	2				60.0	.3	9	2	.3	167	2		
	72.0	1.1	56	1	+2	67	2				64.0	1.9	78	2	.1	119	2		
	76.0	.8	44	2	+5	72	2				68.0	1.0	70	2	.1	11	2		
	80.0	1.1	25	3	+2	38	2				72.0	1.4	66	2	.7	15	2	1.8	51
	84.0	.6	87	2	+2	129	2				76.0	.2	177	2	.2	177	2		
	88.0	2.0	58	2	+1	76	2				80.0	1.5	37	2	.3	151	7	4.0	66
	92.0	.3	129	2	+4	12	2				84.0	1.9	34	2	.3	158	4	4.7	56
	96.0	.9	150	2	+4	162	4				88.0	1.7	34	2	.1	109	3		
	100.0	.8	161	2	+5	122	2				92.0	1.8	143	2	.3	140	2	4.4	3
	104.0	.9	119	2	+2	140	2				96.0	1.4	138	2	.2	99	2		
	108.0	1.6	104	2	+1	135	2				100.0	1.7	111	2	.6	101	3	2.8	10
	112.0	1.2	91	2	+0		2				104.0	.6	107	2	.7	111	2		
	116.0	1.6	60	2	+3	99	2	4.0	-39		108.0	.8	90	2	.3	115	2		
	120.0	1.2	25	2	+1	78	2				112.0	1.1	65	2	.6	111	2	1.4	-46
	124.0	1.5	168	2	+0		2				116.0	1.0	53	2	.2	85	2		
	128.0	.5	136	2	+4	116	2				120.0	.3	39	2	.2	87	2		
	132.0	1.3	106	2	+4	62	2	3.0	44		124.0	.3	0	2	.2	45	1		
	136.0	1.0	63	1	+5	77	2	2.0	-14		128.0	.6	110	1	.1	97	2		
	140.0	.6	52	2	+6	57	2				132.0	.8	85	2	.2	53	2		
	144.0	.8	15	2	+4	77	2				140.0	.6	58	2	.5	94	2		
	148.0	.9	167	2	+9	126	2				144.0	1.0	15	2	.4	167	2	2.3	28
	152.0	.4	107	2	+6	21	2				148.0	.8	123	2	.4	1	2		
	156.0	1.3	131	1	+3	22	2	3.7	-71		152.0	.2	162	2	.2	5	2		
	160.0	1.8	9	2	+5	22	2	3.1	-13		156.0	.4	143	2	.5	147	2		
	164.0	.9	114	2	+8	3	2				160.0	1.1	140	2	.5	126	2	2.0	14
	168.0	.7	170	2	+8	10	2				164.0	.7	112	2	.4	129	2		
	172.0	.3	44	2	+4	15	2				168.0	.6	92	2	.2	123	2		
	176.0	.9	87	2	+2	35	2				172.0	.8	92	2	.3	63	2		
	180.0	.8	48	2							176.0	2.2	74	2	.3	67	2	5.0	7
	184.0	.7	111	2							180.0	1.1	46	2					
	192.0				+1	16	2				192.0				.1	62	2		
	196.0				+1	7	4				196.0				.0		4		
	350.0	1.0	33	2							344.0	.9	155	2					
	352.0	1.0	59	2							348.0	1.1	162	2					
	354.0	1.2	44	2							352.0	.6	25	2					
	356.0	.5	9	2							356.0	1.1	41	2					
	358.0	1.3	21	2						44.6	25.6	2.2	24	1					
41.0	27.8	2.0	17	1							46.4	1.9	20	3					
	47.4	.6	79	2							44.8	100.3	1.3	50	1				
41.7	26.7	1.7	63	1							45.2	28.5	1.0	72	1				
42.0	0.0	.6	176	2							45.5	80.0	1.6	31	1				
	4.0	.8	127	2							133.7	.6	69	2	.4	32	2		
	8.0	1.6	140	2	1.1	175	4	1.0	-35		46.0	0.0	.8	42	2	.7	120	2	
	12.0	1.2	171	2	1.5	6	2	-0.7	-15			4.0	.6	76	2				
	16.0	.6	166	2	.5	172	2				8.0	.1	143	2	1.3	123	3		
	20.0	1.2	19	2	+3	4	2	3.4	15		12.0	.1	147	2	.7	140	2		
	24.0	1.3	63	2	+3	157	2	4.0	86		16.0	1.6	81	2	.7	31	2	2.0	50
	27.3	1.5	17	1							20.0	.4	40	2	.3	85	2		
	28.0	1.7	68	2	+4	145	2	3.9	-77		24.0	1.9	48	2	.3	164	2	4.4	64
	32.0	.7	62	2	+1	23	3				28.0	.9	56	2	1.0	146	2		
	36.0	.4	29	2	+2	103	2				32.0	.3	66	2	.2	112	2		
	40.0	.1	11	2	+5	97	2				34.0	.8	160	5	.7	121	2		
	44.0	.5	137	2	+6	104	2				36.0	.9	126	2	.3	145	2		
	48.0	1.4	42	2	+2	139	2				40.0	.5	124	2	.5	137	2		
	52.0	1.2	51	2	+5	136	2	1.9	-85		44.0	1.9	22	2	1.0	123	2	1.6	79
	56.0	1.0	43	2	+1	156	2				48.0	.7	167	2	.5	119	2		
	60.0	.4	50	2	+1	11	2				52.0	1.2	51	2	.4	38	2	2.8	13
	64.0	.8	61	2	+0		2				56.0	.9	56	2	.7	88	2		
	68.0	.9	38	2	+0		2				60.0	.7	101	2	.1	156	2		
	72.0	.8	63	1	+1	72	2				64.0	2.1	61	2	.4	92	2	4.0	-31
	76.0	.1	72	2	+3	16	2				68.0	1.6	48	2	.1	168	2		
	80.0	.8	63	3	+2	70	2				72.0	.6	51	2	.4	64	2		
	84.0	1.1	43	2	+2	168	2				76.0	.9	54	2	.4	40	2		
	88.0	1.1	38	2	+3	36	2	3.2	2		80.0	1.0	40	2					
	127.3	.1	144	2	+2	47	1				84.0	.6	3	2	.4	12	2		
	184.0	.3	100	2							88.0	.4	52	2	.2	5	2		
	348.0	2.5																	

TABLE 2 (continued)

LAT	LONG	INT 408	THETA 408	N 408	INT 610	THETA 610	N 610	SP.1.	DIF	LAT	LONG	INT 408	THETA 408	N 408	INT 610	THETA 610	N 610	SP.1.	DIF	
47.4	124.0	.2	36	2	.3	115	2			50.0	352.0	.3	135	4	.4	85	2			
47.6	42.5	1.1	15	1							356.0	.3	146	2	.3	143	2			
48.0	8.0	1.0	179	2	.9	176	2	0.3	3	50.7	21.3	1.6	11	1						
	12.0	1.2	163	2	.5	3	2	2.3	-20		148.0	1.7	174	2						
	16.0	.9	178	2	.7	77	2			51.6	131.3	1.1	56	2	.6	106	2	1.6	-50	
	20.0	1.6	34	2	.5	164	2	2.8	50	52.0	0.0	.6	90	2	.4	55	2			
	23.0	2.2	21	1							4.0	1.0	98	2	.2	51	2			
	24.0	2.0	31	2	.7	120	2	2.6	-89		8.0	1.1	83	2	.9	30	2	0.5	53	
	28.0	1.7	43	2	1.0	153	2	1.4	70		12.0	.4	38	2	1.3	7	2			
	32.0	1.8	142	2	.7	90	2	2.4	52		16.0	1.4	59	2	.5	34	2	2.6	25	
	36.0	1.2	117	2	.5	114	2	2.2	3		20.0	.4	99	2	.6	38	2			
	40.0	.9	146	2	.1	40	2				24.0	1.2	81	2	.1	154	2			
	44.0	.2	154	2	.9	91	2				28.0	1.3	52	2	1.2	21	2	0.2	31	
	45.4	.8	170	5							36.0	2.1	98	2	.9	79	2	2.1	19	
	48.0	.3	38	2	.5	65	2				40.0	1.2	101	2	.7	83	2	1.3	18	
	52.0	1.1	89	2	.8	12	2	0.6	77		41.0	.5	146	1						
	56.0	1.2	90	2	.2	31	2				44.0	1.4	78	2	1.0	60	2	0.8	18	
	60.0	1.4	74	2	.2	129	2				48.0	1.7	17	2	.5	24	2	3.2	-7	
	64.0	2.0	15	2	.2	141	2				52.0	1.3	11	2	.4	172	2	2.8	19	
	68.0	1.9	10	2	.4	2	2	4.0	8		56.0	.8	146	2	.6	31	2			
	72.0	.7	8	2	.1	0	2				60.0	1.2	149	2	.3	6	2	3.9	-37	
	76.0	.6	107	2	.1	147	2				64.0	1.9	104	2	.4	169	2	3.8	-65	
	80.0	.6	102	2	.3	134	2				68.0	1.2	97	2	.3	145	2	3.6	-48	
	84.0	.2	93	2	.1	122	2				72.0	1.0	127	2	.3	138	2	3.3	-11	
	88.0	.2	65	2	.3	167	2				76.0	.3	89	2	.3	114	6			
	92.0	1.3	141	2	.1	135	2				80.0	.2	51	2	.1	93	4			
	96.0	.9	138	2	.3	153	2				84.0	.2	76	2	.1	150	4			
	100.0	1.8	123	2	.3	173	2	4.5	-50		88.0	.4	7	2	.1	135	4			
	104.0	2.2	94	2	.4	160	2	4.2	-66		92.0	1.2	156	2	.1	115	4			
	108.0	2.3	96	2	.6	152	2	3.5	-56		96.0	1.2	152	2	.1	47	4			
	112.0	1.4	88	2	.5	135	2	2.4	-47		100.0	.3	123	2	.2	29	4			
	116.0	.3	116	2	.2	135	2				104.0	1.3	68	1	.5	55	4	2.6	13	
	132.0	.4	165	2	.3	46	2				108.0	2.0	44	2	.4	31	4	4.1	13	
	136.0	.9	28	4	.1	64	2				112.0	1.1	31	2	.4	4	2	2.4	27	
	140.0	.1	65	4	.2	44	2				116.0	1.4	120	1	.5	164	2	2.6	-44	
	144.0	.5	17	2	.2	42	2				117.7	1.2	134	2	.5	158	2	2.3	-24	
	148.0	1.0	32	3	.6	31	2	1.5	-19		128.0	1.5	77	2	.6	121	2	2.5	-44	
	152.0	1.3	36	2	.7	65	2	1.4	-29		152.0	.8	110	2	1.0	112	2			
	156.0	2.0	20	2	.8	47	2	2.2	-27		156.0	2.8	127	2	.9	110	2	2.8	17	
	160.0	.2	132	3	.4	45	2				160.0	2.0	123	2	.7	102	2	2.7	21	
	164.0	1.1	168	2	.5	34	2	2.0	-46		164.0	1.1	149	2	.4	125	2	2.3	24	
	168.0	.8	22	2	.5	46	2				168.0	.9	109	2	.4	156	2			
	172.0	1.1	64	2	.3	44	2	3.1	20		172.0	.4	128	2	.2	124	2			
	176.0	1.3	87	2	.3	58	2	3.3	29		176.0	.9	46	2	.1	158	2			
	180.0	.3	60	2	.0		2				180.0	1.4	41	2	.1	135	2			
	184.0	.5	49	2	.1	102	2				184.0	1.2	56	2	.1	19	2			
	192.0				.1	116	2				192.0				.1	135	2			
	196.0				.1	117	4				196.0				.2	175	2			
	336.0	.4	42	2							340.0	.6	69	2						
	340.0	.8	26	2							344.0	.3	93	2	.3	36	1			
	344.0	.5	176	2							348.0	.7	86	2	.4	58	2			
	348.0	.7	2	2							352.0	.7	78	2						
48.4	48.3	.7	9	1							356.0	.8	72	2	.6	22	2			
48.5	92.4	1.9	137	1						52.3	103.6	1.9	80	1						
48.8	54.4	.2	113	1							133.0	1.0	21	26	.5	95	2	1.6	-74	
49.0	22.6	2.2	17	1						52.4	124.6	1.7	104	2	.8	144	2	1.9	-40	
	332.6	1.1	11	2						52.7	47.4	1.6	29	1						
49.3	355.0	.5	120	2						53.0	10.5	.7	24	1	1.5	175	2			
49.6	16.0	.5	118	2							54.0	2.6	176	1	.2	157	2			
	137.4	.2	34	2	.1	21	2			53.6	14.5	1.3	25	1	.4	179	2	3.0	26	
										53.7	342.0				.3	60	2			
50.0	0.0	.7	164	4	.6	65	3			53.8	154.3	2.0	166	3						
	4.0	.5	21	4	.6	80	2			54.0	0.0	.2	44	2	.6	125	3			
	8.0	.2	68	2	.5	106	3				4.0	.7	82	2	1.1	174	2			
	12.0	.6	8	2	.9	63	2				8.0	1.9	22	2	.6	137	2	3.0	65	
	16.0	.5	177	2	.5	104	3				12.0	2.0	7	2	.4	139	2	4.0	48	
	20.0	.9	69	2	.5	68	2				16.0	.8	90	2	.0		3			
	24.0	.9	35	2	.5	66	3				20.0	.6	75	2	.3	130	2			
	28.0	1.8	43	2	1.0	75	2	1.6	-32		24.0	1.8	62	2	1.0	165	4	1.5	77	
	32.0	1.1	90	2	.8	96	2	1.0	-6		28.0	2.7	60	2	.1	97	2			
	36.0	1.1	122	2	.5	125	2	1.9	-3		32.0	1.1	74	2	.9	92	2	0.6	-18	
	40.0	1.2	155	1	.5	114	2	2.4	41		36.0	.8	107	2	.7	37	2			
	44.0	.6	171	2	.7	50	2				40.0	.7	133	2	.5	57	2			
	48.0	1.2	41	2	.3	23	2	3.3	18		44.0	1.5	39	2	.3	178	2	3.8	41	
	52.0	1.1	9	2	.6	18	2	1.5	-9		48.0	1.3	7	2	.5	136	2	2.3	51	
	56.0	1.1	21	2	.2	109	2				52.0	.2	171	2	.4	167	2			
	60.0	.9	35	2	.4	101	2				56.0	.8	155	2	.1	144	2			
	64.0	1.6	142	2	.2	139	2				60.0	.6	154	2	.2	127	2			
	68.0	1.0	172	2	.2	86	2				64.0	1.0	117	2	.8	173	2	0.7	-56	
	72.0	1.1	125	2							69.0	1.1	86	2	.3	139	2	3.1	-53	
	76.0	1.0	105	2	.3	49	2	3.3	56		72.0	1.1	79	2	.4	146	2	2.3	-67	
	80.0	.3	58	2	.3	167	2				76.0	.7	70	2	.5	152	2			
	84.0	.6	90	2	.3	178	2				84.0	.4	62	2	.3	173	2			
	88.0	1.2	56	2	.2	26	2				88.0	.8	10	2	.3	178	2			
	169.0				.0		1				142.0	1.2	11	3						
	332.0	1.1	82	2	.5	46	2	1.8	36		154.0				.6	137	2			
	336.0	.8	96	1	.3	54	2				332.0	.2	88	2	.3	136	3			
	340.0	.5	79	2	.4	88	2				336.0	.9	49	3	.4	70	2			
	344.0	.5	93	2	.3	48	2				340.0	.9	29	2	.3	91	3			
	348.0	.6	76	2	.4	53	2				344.0	.5	37	2	.4	101	2			

LINEAR POLARIZATION OF THE GALACTIC BACKGROUND AT 50 CM

TABLE 2 (continued)

LAT	LONG	INT 408	THETA 408	N 408	INT 610	THETA 610	N 610	SP.1.	DIF	LAT	LONG	INT 408	THETA 408	N 408	INT 610	THETA 610	N 610	SP.1.	DIF
54.0	348.0	.8	23	2	.0		3			59.3	120.0	1.7	2	17	.3	9	12	4.6	-7
	352.0	.3	56	2	.1	27	3			60.0	0.0	2.2	175	2					
	356.0	.4	129	2	.3	104	2				4.0	2.5	167	2	.8	64	2	2.8	-77
54.4	78.5	.7	84	2							8.0	2.9	147	2	1.2	68	2	2.3	79
54.6	136.0	2.8	27	1	.7	92	2	3.3	-65		12.0	2.6	166	2	.9	90	2	2.5	76
54.8	29.0	2.4	75	2	.8	123	2	2.8	-48		4.1	176	2	1.2	104	2	3.0	72	
55.2	139.0	2.3	23	1	.6	88	2	3.3	-65		20.0	2.7	149	2	1.3	98	2	1.8	51
56.0	24.0	1.0	18	2	2.1	105	2	1.8	-87		24.0	1.1	132	2	.8	109	2	0.6	23
	28.0	1.7	28	2	.7	129	2	2.1	79		28.0	1.7	1	2	1.4	111	1	0.5	70
	32.0	1.4	42	1	.2	68	2				32.0	1.0	172	2	.4	137	2	2.4	35
	36.0	.9	51	4							36.0	.6	174	2	.5	104	2		
	38.0				.7	147	2				40.0	.6	158	2	1.0	106	2		
	40.0	1.6	54	2							40.0	2.0	29	2	.2	148	2		
	44.0	2.1	12	2	.3	125	2	5.1	67		50.0	2.6	21	2	.5	126	2	4.1	75
	48.0	1.6	158	2	.4	117	2	3.7	41		55.0	2.9	170	2	.5	137	2	4.3	33
	52.0	.3	23	2	.8	6	2				60.0	2.1	178	2					
	56.0	.9	46	2	.5	10	2				65.0	.2	158	2	.2	67	2		
	60.0	.7	17	3	.3	173	2				70.0	1.1	97	2	.7	9	2	1.1	88
	64.0	.4	163	3	.6	175	2				75.0	.5	47	2	.6	152	2		
	68.0	.7	112	2	.2	128	2				80.0	1.2	41	2	.3	24	2	3.4	17
	72.0	1.0	73	2	.6	5	2	1.1	68		85.0	.9	55	2	.2	19	2		
	76.0	.0		2	.6	71	2				88.0	.2	169	2	.0		2		
	80.0	.1	53	2	.9	27	2				90.0	.8	58	2	.2	82	2		
	84.0	.1	113	2	.5	9	2				96.0	.3	137	2	.4	152	2		
	88.0	.5	166	2	.1	150	2				104.0	1.4	126	2	.2	83	2		
	92.0	1.1	169	2	.3	153	2	3.0	16		112.0	1.4	70	2	.4	41	2	3.0	29
	96.0	2.5	135	2	.2	106	2				120.0	1.7	10	1	.5	2	2	3.0	8
	100.0	2.5	149	2	.4	147	2	4.3	2		125.0				.7	166	2		
	104.0	1.4	92	2	.1	161	2				130.0				.6	168	2		
	108.0	1.9	63	2	.2	26	2				135.0				.7	136	2		
	112.0	1.8	17	2	.5	32	2	3.3	-15		140.0				.8	108	2		
	120.0	1.1	35	2	.5	27	2	2.3	8		145.0				.8	134	2		
	128.0	2.4	88	2	.5	140	2	4.0	-52		152.0	.3	76	2	.1	137	3		
	140.0	2.5	35	1	.7	96	2	3.3	-61		160.0	.4	165	2	.3	166	3		
	144.0	1.2	25	2	.4	108	2	2.8	-83		168.0	.7	97	2	.2	38	2		
	152.0	1.2	13	2	.6	170	2	2.0	23		176.0	.3	75	2	.1	174	1		
	156.0	.2	77	2	.1	169	2				184.0	1.1	64	2	.1	3	2		
	160.0	.7	170	2	.3	155	2				188.0	.9	56	2	.1	176	2		
	164.0	1.2	117	2	.4	138	2	2.5	-21		192.0				.1	62	2		
	168.0	.1	77	2	.1	0	2				332.0	1.5	53	2	.3	41	2	4.0	12
	172.0	1.0	70	2	.1	154	2				336.0	.7	119	2	.2	66	2		
	176.0	1.3	73	2	.0		2				340.0	.5	99	2	.4	79	2		
	180.0	1.4	59	2	.1	27	2				344.0	.8	96	2	.6	96	2		
	184.0	1.2	73	2	.3	31	2	3.4	42		348.0	1.2	82	2	.8	96	2	1.2	-14
	192.0				.2	175	2				352.0	1.6	51	2	.7	99	2	2.0	-48
	196.0				.3	7	2				356.0	1.3	5	2	.8	73	2	1.3	-68
	332.0	.7	65	2	.2	69	2			60.3	120.0	1.0	164	1	.0		1		
	336.0	.3	40	2	.1	71	2			60.4	34.0	1.2	8	2	.6	148	2	1.8	40
56.3	340.0	.2	3	2	.2	64	2			60.5	161.6	.3	11	1					
56.4	134.0	.9	46	3	.5	96	2			60.8	38.0	1.3	89	1					
56.7	39.4	1.8	64	1						61.0	42.0	.8	38	2					
	43.0	1.7	175	2							137.6	.6	121	4					
	145.0	1.4	22	1						61.2	54.4	3.7	175	1					
57.0	46.6	2.0	173	1						61.3	46.0	2.9	46	1					
	54.0	2.1	20	1	.6	166	2	3.2	34	61.8	105.0				.3	90	1		
	116.0	1.6	164	48	.3	18	2	3.9	-34		113.6	.9	42	3	.2	44	2		
57.4	125.0	1.3	148	3	.5	169	2	2.5	-21	62.0	0.0	2.5	124	2	1.2	67	1	1.8	57
58.0	0.0	1.4	4	4	.7	88	3	2.0	-84		5.0	3.5	163	2	1.4	82	2	2.4	81
	4.0	1.1	171	4	.6	66	2	1.7	-75		10.0	3.6	8	2	1.2	114	2	2.7	74
	8.0	1.3	144	4	.8	72	3	1.1	72		15.0	2.6	12	2	2.3	98	2	0.4	-86
	12.0	.7	128	7	.6	77	2				20.0	3.0	28	2	1.6	122	6	1.5	86
	16.0	1.1	132	4	1.4	88	5	-0.5	44		25.0	2.7	54	2	.4	115	2	4.8	-61
	20.0	1.0	140	4	1.8	92	2	-1.5	48		30.0	1.9	34	2	.7	124	1	2.4	90
	24.0	1.6	155	2	1.7	106	4	0.1	49		35.0	1.6	20	2	.8	117	2	1.6	83
	28.0	1.7	5	2	1.1	94	2	1.2	-89		40.0	1.5	21	2	.4	106	2	3.0	-85
	32.0	2.3	20	2	1.0	128	2	2.1	72		45.0	2.5	51	2	.4	131	2	4.6	-80
	36.0	1.9	14	2	.8	139	2	2.0	55		50.0	2.1	23	2	.6	150	2	3.1	53
	40.0	1.1	167	2	1.2	111	2	-0.2	56		55.0	2.2	2	2	.6	118	2	3.2	64
	44.0	.7	14	2	.6	85	2				60.0	.9	5	2	.4	144	2		
	48.0	1.7	0	2	.6	120	2	2.8	60		65.0	1.3	39	2	.5	81	2	2.5	-42
	52.0	2.8	170	2	.7	139	5	3.4	31		70.0	1.5	126	2	.7	1	2	1.8	-55
	56.0	1.8	175	2	.5	1	2	3.3	-6		75.0	.3	46	2	.8	161	2		
	60.0	1.8	178	2	.8	16	1	1.8	-18		80.0	.7	50	3	.4	0	2		
	64.0	1.1	6	2	.6	176	2	1.4	10		85.0								
	68.0	.7	148	2	.3	2	2				90.0	1.1	54	2	.3	178	2	2.9	56
	72.0	.3	97	2	.8	171	2				95.0	.8	71	2	.2	132	2		
	76.0	.9	124	2	.5	133	2				100.0				.1	107	2		
	80.0	.1																	

TABLE 2 (continued)

LAT	LONG	INT 408	THETA 408	N 408	INT 610	THETA 610	N 610	SP.1.	DIF	LAT	LONG	INT 408	THETA 408	N 408	INT 610	THETA 610	N 610	SP.1.	DIF		
62.0	160.0				.5	144	2			66.0	85.0	1.0	16	2	.3	2	2	2.8	14		
	165.0				.3	93	3				90.0	1.0	21	2	.3	0	2	2.9	21		
	170.0				.1	96	2				95.0				.3	74	2				
	175.0				.7	75	3				100.0				.3	57	2				
	180.0				.2	175	2				105.0				.6	66	2				
	185.0				.1	80	2				110.0				.1	56	2				
	190.0				.3	156	2				115.0				.2	56	2				
	195.0				.2	93	2				120.0				.5	36	2				
	200.0				.0		2				125.0				.2	35	2				
	210.0				.2	151	2				130.0				.4	179	2				
	330.0	.8	178	2	.6	55	3				135.0				.5	8	2				
	335.0	1.7	176	2	.9	69	2	1.6	-73		140.0				.4	160	2				
	340.0	1.7	18	2	.6	95	2	2.8	-77		145.0				.4	6	2				
	345.0	.5	131	2	1.0	67	2				150.0				.2	166	2				
	350.0	2.0	151	2	.4	64	3	4.0	87		155.0				.4	1	2				
	355.0	1.1	5	2	1.2	68	2	-0.3	-63		160.0				.3	0	2				
62.3	126.0		.8	150	3						165.0				.4	22	2				
63.3	179.6		1.1	72	1						170.0				.1	153	2				
63.4	8.0		5.0	0	585	1.3	108	202	3.3	72		175.0			.5	8	2				
63.6	23.0		1.1	53	2						180.0				.2	166	2				
64.0	0.0		3.7	131	2	1.5	73	2	2.2	58		185.0			.1	51	2				
	5.0		5.0	170	2	1.6	92	2	2.8	78		190.0			.2	151	2				
	10.0		3.9	13	2	1.8	103	2	1.9	90		195.0			.1	81	2				
	15.0		1.9	45	2	1.3	109	2	0.9	-64		200.0			.1	155	2				
	20.0		.8	60	2	.9	117	2				205.0			.2	109	4				
	25.0		1.6	27	2	1.2	103	2	0.7	-76		210.0			.2	168	2				
	30.0		2.7	48	2	1.2	129	2	2.1	-81		330.0	.5	14	2	.2	150	2			
	35.0		1.2	50	2	.7	171	2	1.4	59		335.0	1.1	6	2	.6	179	2	1.6	7	
	40.0		.7	57	2	.4	8	2				340.0	1.9	36	2	.8	29	2	2.1	7	
	45.0		2.0	88	2	.3	19	2	4.3	69		345.0	2.6	34	2	1.2	19	2	1.9	15	
	50.0		2.6	87	2	.4	6	2	4.7	81		350.0	4.5	61	2	1.2	42	2	3.3	19	
	55.0		1.7	48	2	.1	158	2				355.0	4.1	83	2	1.4	49	2	2.7	34	
	60.0		.7	114	2	.8	91	2			67.0	142.5		.4	48	1					
	65.0		2.7	14	2	.9	40	2	2.7	-26	67.5	47.0			.5	143	1				
	70.0		1.4	159	2	.7	23	2	1.9	-44	68.0	0.0	2.0	120	2	1.4	80	4	0.9	40	
	75.0		.6	3	2	.4	2	2				5.0	1.6	145	2	1.4	69	2	0.5	76	
	80.0		.4	17	2	.3	1	2				10.0	1.4	127	2	1.1	72	2	0.7	55	
	85.0		1.0	51	2	.4	20	2	2.5	31		15.0	.7	76	3	1.8	70	2			
	88.0		.4	32	2	.5	56	2				20.0	1.3	81	2	1.1	131	2	0.4	-50	
	90.0		.9	67	2	.4	68	2				25.0	.9	88	3	.8	126	2			
	96.0		.6	145	2	.2	68	2				30.0	2.5	86	3	1.2	154	2	1.7	-68	
	98.0				.3	1	1					35.0	2.4	59	2	.3	172	2	4.9	67	
	104.0		2.3	125	2	.2	106	2				40.0	2.6	50	10	.5	130	6	4.1	-80	
	112.0		.8	141	2	.4	108	1				45.0	1.7	68	2	.7	120	4	2.4	-52	
	122.6		2.3	98	1	.6	8	2	3.3	90		50.0	1.6	63	2	.4	113	2	3.3	-50	
	128.0		1.0	47	2	.6	20	2	1.1	27		55.0	.1	88	2	1.0	89	4			
	136.0		.9	37	2	.4	173	2				60.0	1.2	87	2	.8	75	2	1.0	12	
	144.0		.8	40	2	.4	160	2				65.0	.6	87	2	.8	60	2			
	152.0		.3	59	2	.3	138	1				70.0	1.4	36	2	.8	44	2	1.3	-8	
	160.0		.8	28	2	.1	126	2				75.0	1.3	36	2	.7	36	2	1.6	0	
	168.0		.6	32	2	.1	177	2				80.0	1.1	178	2	.6	18	2	1.8	-20	
	176.0		.3	33	2	.1	165	2				85.0	.9	1	2	.4	18	2			
	184.0		.9	73	2	.1	7	2				88.0	.7	169	2						
	187.6				.1	41	2					90.0	.6	13	2	.4	17	1			
	188.0		1.0	66	2							96.0	.4	149	2	.3	92	2			
	190.0				.2	174	2					104.0	.6	110	2	.5	73	2			
	195.0		.1	84	1	.1	84	1				112.0	1.8	129	2	.5	76	2	3.1	53	
	200.0		.2	133	2							120.0	1.4	132	1	.5	64	1	2.4	68	
	205.0		.0									128.0	1.0	54	2	.7	41	1	1.1	13	
	210.0		.2			30	2					136.0	1.0	6	2	.2	22	1			
	330.0	.9	167	2	.9	36	2					144.0	.5	24	2	.1	130	1			
	335.0	.1	24	2	1.1	44	2					152.0	.2	17	2	.1	94	2			
	340.0	1.2	72	2	.8	55	2	1.1	17			160.0	.4	73	2	.0		2			
	345.0	1.8	63	2	1.2	43	2	1.1	20			168.0	.6	50	1	.1	69	1			
	350.0	3.1	56	2	1.0	40	2	2.9	16			176.0	.6	51	2	.1	20	2			
	355.0	1.9	92	2	1.2	56	2	1.1	36			184.0	.7	61	2	.2	16	2			
65.0	31.5		1.8	72	2							188.0	1.0	74	2	.1	13	2			
	71.0		1.0	12	1							190.0				.1	108	2			
65.2	339.0		1.5	60	1							195.0				.1	0	2			
65.3	36.0		.9	82	1							200.0				.2	99	2			
65.4	55.4		1.7	54	1							210.0				.1	69	1			
65.5	41.0		1.5	79	2							330.0	.8	55	2	.6	142	2			
65.6	46.0		1.2	106	1							350.0	3.6	107	2	1.2	65	2	2.7	42	
66.0	0.0		3.8	122	2	1.2	78	2	2.9	44		355.0	3.1	100	4	1.4	47	2	1.9	53	
	5.0		3.3	151	2	1.8	81	2	1.6	70		68.2	169.0	.4	67	1	.3	56	1		
	10.0		2.0	172	2	1.0	85	3	1.6	87											
	15.0		2.8	67	2	2.4	73	4	0.3	-6											
	20.0		1.7	95	2	1.2	83	1	0.8	12		70.0	0.0	.9	98	2	1.3	43	2	0.1	36
	25.0		.7	42	2	.7	104	2				5.0	1.6	81	2	1.6	45	2			
	30.0		1.4	57	2	.7	165	4	1.9	72		10.0	2.6	93	2	.8	46	2	2.9	47	
	35.0		1.2	72	2							15.0	.7	107	2	1.5	100	2			
	40.0		2.0	46	2	.5	138	2	3.3	88		19.5				.4	165	1			
	45.0		2.1	84	2							20.0	1.0	72	2	.6	4	2	1.5	68	
	50.0		3.1	84	2	.6	146	2	4.0	-62		25.0	.7	80	2	.8	171	3			
	55.0		1.3	70	2							50.0	1.3	84	2	.7	141	2	1.4	-57	
	60.0		2.4	83	2	.8	86	2	2.9	-3		55.0	1.5	72	2						
	65.0		1.3	32	2	.9	45	2	1.0	-13		60.0	2.7	61	2	.5	53	2	4.1	8	
	70.0		.8	42	2	.3	53	2				66.0	1.9	31	2						
	75.0		1.0	12	2	.8	30	2	0.5	-18		70.0	.6	35	2	.1	78	2			
	80.0		1.1	168	2	.5	175	2	1.8	-7		75.0	1.0	79	2						
												80.0	.7	43	2	.1	119	2			

LINEAR POLARIZATION OF THE GALACTIC BACKGROUND AT 50 CM

TABLE 2 (continued)

LAT	LONG	INT 408	THETA 408	N 408	INT 610	THETA 610	N 610	SP.1.	DIF	LAT	LONG	INT 408	THETA 408	N 408	INT 610	THETA 610	N 610	SP.1.	DIF
70.0	85.0	.9	5	2	.3	107	2			74.0	190.0				.3	87	2		
	90.0	.3	165	2	.5	110	2				200.0				.2	74	2		
	95.0				.3	97	2				210.0				.4	95	2		
	100.0				.4	54	2				330.0	.8	39	2	.7	19	2		
	105.0				.3	55	2				340.0	1.8	17	2	.8	22	2	2.2	-5
	110.0				.6	58	2				350.0	1.9	160	2	.9	12	2	2.0	-32
	115.0				.4	70	2			75.0	185.0				.4	66	1		
	120.0				.3	74	2			76.0	0.0	1.1	1	2	1.6	13	2	-1.0	-12
	125.0				.2	31	2				6.0				1.2	19	1		
	130.0				.4	30	2				10.0	.5	81	2	1.3	37	2		
	135.0				.4	23	2				20.0	.7	64	2					
	140.0				.2	166	2				30.0	.2	105	2	.6	103	2		
	145.0				.2	142	2				40.0	.9	139	2	.5	131	2		
	150.0				.2	100	2				50.0	1.8	121	4	.8	98	2	2.0	23
	155.0				.2	127	2				60.0	2.1	134	2	.8	73	4	2.3	61
	160.0				.1	145	2				70.0	1.3	130	3	.5	53	2	2.3	77
	165.0				.2	150	2				80.0	1.3	175	3	.4	82	2	2.9	-87
	170.0				.1	137	2				90.0	1.2	173	4	.3	96	2	3.4	77
	175.0				.2	140	2				100.0	.2	108	2	.2	170	2		
	180.0				.3	155	2				110.0	.6	151	2	.3	127	2		
	185.0				.2	117	2				120.0	.4	88	2	.6	144	2		
	190.0				.2	100	2				130.0	.3	24	2	.3	84	2		
	195.0				.2	103	2				140.0	.4	107	2	.1	54	2		
	200.0				.2	135	3				150.0	.9	122	2	.1	109	2		
	205.0				.0		3				155.0	1.1	110	2	.1	9	2		
	210.0				.1	62	2				160.0	1.0	118	2	.1	20	2		
	330.0	.8	0	2	.6	160	2				170.0	.6	88	2	.0	2	2		
	335.0	1.7	12	4	.6	179	2	2.7	13		180.0	.4	62	2	.1	135	2		
	340.0	2.0	26	4	.9	6	2	2.0	20		190.0	.8	87	1	.2	137	2		
	345.0	1.0	74	4	.8	37	2	0.6	37		200.0				.2	143	2		
	350.0	1.3	91	2	1.0	48	2	0.6	43		210.0				.2	77	2		
71.0	200.0				.1	125	2				330.0	2.7	19	2	1.1	39	2	2.3	-20
71.3	128.0	1.4	94	40							340.0	3.2	20	2	1.4	44	1	2.1	-24
72.0	0.0	2.0	77	2	1.7	50	3	0.4	27		350.0	.7	39	2	1.2	33	2		
	5.0	2.5	107	2	2.0	72	2	0.6	35	76.2	190.0	.3	71	1					
	10.0	1.9	105	2	1.8	68	2	0.1	37	78.0	0.0	1.4	33	3	1.1	28	2	0.6	5
	15.0	1.2	96	2	1.0	115	2	0.6	-19		10.0	1.1	74	3	.7	75	2	1.2	-1
	20.0	.8	116	2	1.0	144	2				20.0	1.1	85	2	.7	75	2	1.1	10
	25.0	.9	92	2	1.0	137	2				30.0	.8	110	2	.7	91	1		
	30.0	.5	82	2	.9	130	2				40.0	.3	122	1	1.0	118	3		
	35.0				.7	112	4				50.0	2.9	105	2	.5	93	4	4.3	12
	40.0	.5	91	2	.8	135	2				60.0	2.8	91	2	.7	54	2	3.5	37
	50.0	1.1	59	2	.5	108	2	1.7	-49		70.0	1.2	77	2	.3	51	2	3.3	26
	55.0	1.3	63	2	.9	60	2	0.9	3		80.0	.6	81	2	.7	26	2		
	60.0	1.6	55	2	.9	53	2	1.4	2		90.0	1.0	96	2	.4	81	3	2.1	15
	65.0	.5	54	2	1.0	46	2				100.0				.2	63	2		
	70.0	1.0	178	2	.3	59	2	3.1	-61		110.0				.2	109	2		
	75.0	1.3	165	2	.4	82	2	2.8	83		120.0				.2	91	2		
	80.0	2.0	149	2	.3	78	2	4.6	71		130.0				.5	54	2		
	85.0	1.2	39	2	.3	122	2	3.6	-83		140.0				.3	26	2		
	88.0	.1	96	2							150.0	1.0	103	1	.3	56	2	3.0	47
	90.0	1.4	41	2	.2	124	2				155.0	1.1	107	2	.2	36	2		
	96.0	2.0	106	2	.3	51	2	4.5	55		160.0	.7	101	2	.2	166	2		
	104.0	.4	146	2	.2	155	2				170.0				.0		2		
	112.0	1.3	114	2	.3	55	2	4.0	59		180.0				.3	117	2		
	120.0	.5	89	2	.2	2	2				190.0				.2	24	2		
	128.0	.6	105	2	.2	35	2				200.0				.2	146	2		
	136.0	1.0	91	2	.1	81	2				210.0				.2	93	2		
	144.0	.3	65	3	.1	122	2				330.0	1.4	169	2	1.1	175	2	0.7	-6
	152.0	.6	78	2	.4	90	2				340.0	2.6	177	2	1.3	4	2	1.8	-7
	160.0	.2	71	2	.2	93	2				350.0	.6	162	2	1.0	15	3		
	168.0	.5	15	2	.2	73	2												
	176.0	.3	58	2	.1	63	2			80.0	0.0	2.5	43	2	.6	24	2	3.6	19
	184.0	.7	75	2	.0		2				10.0	1.8	70	1	.8	55	2	2.1	15
	188.0	.6	84	2	.2	71	2				20.0	1.6	87	2	.8	70	2	1.7	17
	190.0				.3	111	2				30.0	2.0	98	2	.9	72	2	2.0	26
	210.0				.3	108	2				40.0	.9	16	2	1.0	83	2		
	330.0	1.3	178	2	.7	164	2	1.6	14		50.0	2.0	113	2	.7	91	2	2.5	22
	355.0	.9	17	2	1.0	17	3				60.0	2.4	89	2	1.1	61	2	2.0	28
72.8	4.0	2.8	129	1							70.0	4.2	83	2	.8	49	2	4.0	34
73.6	187.0				.3	72	1				80.0	1.3	73	2	.7	42	2	1.5	31
74.0	0.0	1.5	155	2	.8	174	2	1.6	-19		90.0	2.4	114	2	.7	54	2	2.9	60
	10.0	1.2	129	2	1.1	86	2	0.1	43		100.0				.1	53	2		
	20.0	.1	40	2	.9	111	2				110.0				.3	132	2		
	30.0	.1	35	2	.7	135	2				120.0				.3	92	2		
	40.0	1.0	138	2	.6	146	2	1.4	-8		130.0				.2	57	2		
	50.0	.5	98	2	.8	110	2				140.0				.3	44	2		
	60.0	1.8	104	2	.9	73	2	1.7	31		150.0				.5	44	2		
	70.0	1.2	145	2	.7	104	2	1.4	41		160.0				.4	115	2		
	80.0	1.7	150	2	.6	81	2	2.0	69		170.0				.4	124	2		

TABLE 2 (continued)

LAT	LONG	INT 408	THETA 408	N 408	INT 610	THETA 610	N 610	SP.1.	DIF
82.0	20.0	1.4	83	2	.6	93	2	2.0	-10
	30.0	2.4	103	2	.7	82	2	3.2	21
	40.0	2.3	117	2	.9	99	3	2.4	18
	50.0	1.5	76	2	.9	76	2	1.4	0
	60.0	3.4	41	2	.7	48	2	4.0	-7
	70.0	2.3	39	2	.8	39	2	2.7	0
	80.0	.6	18	2	.6	52	2		
	90.0	2.2	148	2	.5	9	2	3.7	-41
	105.0	1.6	160	2	.3	48	2	4.3	-68
	120.0	.4	116	2	.3	70	2		
	135.0	.9	100	2	.4	41	2		
	150.0	1.0	81	2	.3	89	2	3.4	-8
	165.0	.7	28	2	.3	103	2		
	180.0	.3	55	2	.4	106	2		
	195.0	.5	51	2	.3	113	2		
	210.0	.6	35	2	.3	47	2		
	225.0	.6	66	2	.2	39	2		
	240.0	1.1	109	2	.1	147	2		
	255.0	.3	127	2	.1	78	2		
	270.0	1.0	67	2	.4	176	4	2.1	71
	284.0	.8	132	2	.5	30	4		
	300.0	.9	144	2	.2	136	2		
	319.0	1.6	179	2	.3	19	2	3.9	-20
	330.0	2.2	16	2	.4	8	2	4.1	8
	340.0	2.3	21	2	.5	17	2	3.7	4
82.4	16.0				1.1	56	1		
84.0	0.0	1.9	79	2	.8	37	2	2.1	42
	15.0	1.9	75	2	.9	56	2	2.0	19
	30.0	2.6	77	2	1.1	56	2	2.1	21
	45.0	2.0	62	1	.9	53	2	2.0	9
	60.0	2.6	179	2	1.2	14	2	1.9	-15
	75.0	1.5	174	2	.8	8	2	1.4	-14
	91.0	2.2	155	1	.8	161	2	2.6	-6
	105.0	2.0	156	2	.7	158	2	2.7	-2
	121.0	1.6	132	2	.2	76	2		
	135.0	1.6	114	3	.2	29	2		
	151.0	1.3	106	2	.1	15	2		
	165.0	.5	73	2	.5	45	2		
	180.0	.8	60	2	.4	49	2		
	195.0	.6	82	2	.4	5	2		
	210.0	.4	33	2	.1	160	2		
	225.0	.9	67	2	.3	93	2		
	240.0	.7	111	2	.3	95	2		
	255.0	.5	124	2	.2	89	2		
	270.0	.3	156	3	.1	131	2		
	285.0	.7	137	2	.5	72	2		
	299.0	.4	169	2	.2	60	2		
	315.0	1.0	11	2	.4	13	2	2.7	-2
	330.0	2.0	31	2	.7	18	2	2.6	13
	345.0	2.2	67	2	.9	38	2	2.3	29
	349.0	2.3	67	10	.7	48	5	3.0	19
84.3	89.0	2.8	149	1					
86.0	0.0	1.8	39	2	.6	27	2	2.7	12
	30.0	1.6	72	2	.5	48	2	3.1	24
	61.0	1.3	121	2	.8	173	2	1.3	-52
	89.0	.7	152	2	.6	166	2		
	121.0	1.1	108	2	.6	111	2	1.6	-3
	151.0	1.6	113	2	.3	54	2	3.9	59
	179.0	.9	123	2	.3	34	2		
	211.0	.9	79	2	.3	43	2		
	240.0	1.3	92	2	.3	79	2	3.7	13
	270.0	.6	140	2	.2	109	2		
	299.0	.5	158	2	.2	176	2		
	329.0	1.4	137	2	.3	5	2	4.3	-48
88.0	60.0	1.0	2	2	.9	11	2	0.4	-9
	121.0	2.4	132	2	.8	136	2	2.8	-4
	181.0	1.5	105	2	.7	84	4	1.9	21
	239.0	.9	116	2					
	298.0	1.3	142	2	.4	151	2	3.3	-9
	359.0	.8	158	2	.5	36	2		
90.0		1.5	138	2	.7	145	2	1.8	-7

References

- ALFRED BEHR, 1959, *Veröff. Univ. Sternw. Göttingen* No. 126
 ELLY M. BERKHUIJSEN and W. N. BROUW, 1963, *B.A.N.* 17 185
 W. N. BROUW, C. A. MULLER and J. TINBERGEN, 1962, *B.A.N.* 16 213 (No. 518)
 M. M. DAVIS, LOUISE GELATO-VOLDERS and GART WESTERHOUT, *B.A.N.* (in preparation)
 F. F. GARDNER and J. A. ROBERTS (private communication)
 J. S. HALL, 1958, *Pub. U.S. Naval Obs.* 2nd series 17 275
 W. A. HILTNER, 1956, *Ap. J. Suppl.* 2 389
 D. MORRIS and G. L. BERGE, 1964, *Obs. Owens Valley Radio Obs.* No. 2
 C. A. MULLER, ELLY M. BERKHUIJSEN, W. N. BROUW and J. TINBERGEN, 1963, *Nature* 200 155
 J. H. PIDDINGTON and G. H. TRENT, 1956, *Austr. J. Phys.* 9 481
 J. TINBERGEN, *B.A.N.* (in preparation)
 GART WESTERHOUT, CH. L. SEEGER, W. N. BROUW and J. TINBERGEN, 1962, *B.A.N.* 16 187 (No. 518)
 GART WESTERHOUT, 1957, *B.A.N.* 13 201 (No. 475)